

The Collected Works of Ludwig Wittgenstein



All texts copyright © Blackwell Publishers

1. CONTENTS. To view the complete table of contents of **The Collected Works of Ludwig Wittgenstein**, click on the **Contents** icon on the left border of your screen. Click on plus (+) symbols in the Contents window to expand the list of entries. A minus symbol (-) indicates that a list may not be further expanded. While viewing the contents, click on **Levels** under the **Search** menu to view the Contents at the Book, Chapter, Section (etc.) levels. While in the Contents window, you may jump to any location by double-clicking on the line of interest or click on the **Contents** icon to go back to full database view.

2. SEARCH TEXT. To execute a search, click on the **Query** icon on the left border of your screen, type in your search terms in the **Query For:** window, then click on **OK** to execute your search. The page number of each paragraph and page break is given in the text; click on **Hidden** under the **View** menu to also view an abbreviation identifying the work. Two query templates have been provided under the search menu to enable searches of particular works, or to permit jumping to a particular page of a work.

NOTEBOOKS 1914-1916

Page Break ii

Page Break iii

Titlepage

Page iii

NOTEBOOKS 1914-1916 LUDWIG WITTGENSTEIN Second Edition

Edited by
G. H. von WRIGHT
and
G. E. M. ANSCOMBE

with an English translation by
G. E. M. ANSCOMBE

Index prepared by
E. D. KLEMKE

BASIL BLACKWELL
OXFORD

Page Break iv

Copyright Page

Page iv

Copyright © Blackwell Publishers 1998

First published 1961

Second edition 1979

Reprinted 1998

Blackwell Publishers Ltd,
108 Cowley Road, Oxford OX4 1JF
UK

Blackwell Publishers Inc.
350 Main Street, Malden, Massachusetts 02148
USA

All rights reserved. Except for the quotation of short passages for the purposes of criticism and review, no part of this publication may be reproduced, stored in a retrieval system, or transmitted, in any form or by any means, electronic, mechanical, photocopying, recording or otherwise, without the prior permission of the publisher.

Except in the United States of America, this book is sold subject to the condition that it shall not, by way of trade or otherwise, be lent, resold, hired out, or otherwise circulated without the publisher's prior consent in any form of binding or cover other than that in which it is published and without a similar condition including this condition being imposed on the subsequent purchaser.

British Library Cataloguing in Publication Data

A CIP catalogue record for this book is available from the British Library.

ISBN 0-631-12499-3

Printed in Great Britain by Athenaeum Press Ltd, Gateshead, Tyne & Wear
This book is printed on acid-free paper

Page Break 1

PREFACE TO THE SECOND EDITION

Page 1

THE text of this volume has been completely revised for this edition, and a number of misreadings have been corrected. These were mostly very small. The most serious one that I have found was the reading of "u.u." ("und umgekehrt") as "u.U" ("unter Umständen"). The diagram on p. 126 has been corrected in accordance with the MS.

Page 1

The second appendix, *Notes on Logic* 1913, appears here in a different arrangement from that of the first edition. That edition used the text published in the *Journal of Philosophy* (Vol. LIV (1957), p. 484) by J. J. Costelloe: he reported having got it from Bertrand Russell in 1914. There was a different text which the editors had, and which they had also got from Russell. It was clear that the Costelloe version was a slightly corrected total rearrangement of that text under headings, and we assumed that it had been made by Wittgenstein himself.

Page 1

A debt of gratitude is owing to Brian McGuinness, not only for having pointed out some errors of transcription in the first edition, but also for having proved that the Costelloe version was constructed by Russell. The other one is therefore closer to Wittgenstein, the first part of it being his own dictation in English and the rest a translation by Russell of material dictated by Wittgenstein in German. Mr. McGuinness' article giving the evidence for this can be found in the *Revue Internationale de Philosophie*, no. 102 (1972).

Page 1

In the first edition a number of passages of symbolism, in one case with accompanying text, were omitted because nothing could be made of them: they were presumably experimental, but it seemed impossible to interpret them. Nor would it always have been clear what was an exact transcription of them. Photographs of them are printed here as a fourth appendix.

Page 1

At the 20th of December 1914 there was a rough line of adjacent crayonned patches, using 7 colours. This was treated as a mere doodle in the first edition, and so it may be. But, having regard to the subject matter of meaning and negation, which is the topic of the surrounding text, it is possible that there is here an anticipation of *Philosophical Investigations* § 48. A representation of it is printed on the dust cover of this edition.

Page Break 2

[Notebooks: Main Body]

Page 2

Logic must take care of itself. [See 5.473.]

Page 2

If syntactical rules for functions can be set up *at all*, then the whole theory of things, properties, etc., is superfluous. It is also all too obvious that this theory isn't what is in question either in the *Grundgesetze*, or in *Principia Mathematica*. Once more: logic must take care of itself. A *possible* sign must also be capable of signifying. Everything that is possible at all, is also legitimate. Let us remember the explanation why "Socrates is Plato" is nonsense. That is, because *we* have not made an arbitrary specification, NOT because a sign is, shall we say, illegitimate in itself! [Cf. 5.473.]

2.9.14.

Page 2

It must in a certain sense be impossible for us to go wrong in logic. This is already partly expressed by saying: Logic must take care of itself. This is an extremely profound and important insight. [Cf. 5.473.]

Page 2

Frege says: Every well-formed sentence must make sense; and I say: Every possible sentence is well-formed, and if it does not make sense that can only come of our not having *given* any meaning to certain of its parts. Even when we believe we have done so. [Cf. 5.4733.]

3.9.14.

Page 2

How is it reconcilable with the task of philosophy, that logic should take care of itself? If, for example, we ask: Is such and such a fact of the subject-predicate form?, we must surely know what we mean by "subject-predicate form". We must know *whether* there is such a form at all. How can we know this? "From the signs". But how? For we haven't got any *signs* of this form. We may indeed say: We have signs that behave like signs of the subject-predicate form, but does that mean that there really must be facts of this form? That is, when those signs are completely analysed? And here the question arises again: Does such a complete analysis exist? *And if not*: then what is the task of philosophy?!?

Page 2

Then can we ask ourselves: Does the subject-predicate form exist? Does the relational form exist? Do any of the forms exist at all that

Page Break 3

Russell and I were always talking about? (Russell would say: "Yes! that's self-evident." *Ha!*)

Page 3

Then: if *everything* that needs to be shewn is shewn by the existence of subject-predicate SENTENCES etc., the task of philosophy is different from what I originally supposed. But if that is not how it is, then what is lacking would have to be shewn by means of some kind of experience, and that I regard as out of the question.

Page 3

The obscurity *obviously* resides in the question: what does the logical identity of sign and thing signified really consist in? And this question is (*once more*) a main aspect of the whole philosophical problem.

Page 3

Let some philosophical question be given: e.g., whether "A is good" is a subject-predicate proposition; or whether "A is brighter than B" is a relational proposition. *How can such a question be settled at all?* What sort of evidence can satisfy me that--*for example*--the first question must be answered in the affirmative? (This is an extremely important question.) Is the only evidence here once more *that extremely dubious "self-evidence"*? Let's take a question quite like that one, which however is simpler and more fundamental, namely the following: Is a point in our visual field a *simple object*, a *thing*? Up to now I have always regarded such questions as the real philosophical ones: and so for sure they are in some sense--but once more what evidence could settle a question of this sort at all? Is there not a mistake in formulation here, for it looks as if *nothing at all* were self-evident to me on this question; it looks as if I could say definitively that these questions could never be settled at all.

4.9.14.

Page 3

If the existence of the subject-predicate *sentence* does not show everything needful, then it could surely only be shewn by the existence of some particular fact of that form. And acquaintance with such a fact cannot be essential for logic.

Page 3

Suppose we had a sign that *actually* was of the subject-predicate form, would this be somehow better suited

to express subject-predicate propositions than our subject-predicate sentences are? It seems not! Does this arise from the signifying relation?

Page 3

If logic can be completed without answering certain questions, then it *must* be completed *without* answering them.

Page 3

The logical identity between sign and thing signified consists in

Page Break 4

its not being permissible to recognize more or less in the sign than in what it signifies.

Page 4

If sign and thing signified were *not* identical in respect of their total logical content then there would have to be something still more fundamental than logic.

5.9.14.

Page 4

$$\phi(a). \phi(b). aRb = \text{Def } \phi[aRb]$$

Page 4

Remember that the words "function", "argument", "sentence" etc. ought not to occur in logic.

Page 4

To say of two classes that they are identical means something. To say it of two things means nothing. This of itself shews the inadmissibility of Russell's definition.

6.9.14.

Page 4

The last sentence is really nothing but the old old objection against identity in mathematics. Namely the objection that if 2×2 were really the *same* as 4, then this proposition would say no more than $a = a$.

Page 4

Could it be said: Logic is *not* concerned with the analysability of the functions with which it works.

7.9.14.

Page 4

Remember that even an unanalysed subject-predicate proposition is a clear statement of something *quite definite*.

Page 4

Can't we say: It all depends, not on our dealing with unanalysable subject-predicate sentences, but on the fact that our subject-predicate sentences behave in the same way as such sentences in *every* respect, i.e. that the logic of *our* subject-predicate sentences is the same as the logic of those. The point for us is simply to complete logic, and our objection-in-chief against unanalysed subject-predicate sentences was that we cannot construct their syntax so long as we do not know their analysis. But must not the logic of an apparent subject-predicate sentence be the same as the logic of an actual one? If a definition giving the proposition the subject-predicate form is possible at all...?

8.9.14.

Page 4

The "self-evidence" of which Russell has talked so much can only be dispensed with in logic if language itself prevents any logical mistake. And it is clear that that "self-evidence" is and always was wholly deceptive. [Cf. 5.4731.]

Page Break 5

19.9.14.

Page 5

A proposition like "this chair is brown" seems to say something enormously complicated, for if we wanted to express this proposition in such a way that nobody could raise objections to it on grounds of ambiguity, it would have to be infinitely long.

20.9.14.

Page 5

That a sentence is a logical portrayal of its meaning is obvious to the uncaptive eye.

Page 5

Are there functions of facts? e.g. "It is better for this to be the case than for that to be the case?"

Page 5

What, then, is the connexion between the sign p and the rest of the signs of the sentence "that p is the case, is good"? What does this connexion consist in?

Page 5

The uncaptive judgement will be: Obviously in the spatial relation of the letter p to the two neighbouring signs. But suppose the fact "p" were such as to contain no things?

Page 5

"It is good *that* p" can presumably be analysed into "p. it is good *if* p".

Page 5

We assume: p is NOT the case: now what does it mean to say "that p, is good"? Quite obviously we can say that the situation p is good without knowing whether "p" is true or false.

Page 5

This throws light on what we say in grammar: "One word refers to another".

Page 5

That is why the point in the above cases is to say how propositions hang together internally. How the *propositional bond* comes into existence. [Cf. 4.221.]

Page 5

How can a function *refer to a proposition*???? Always the old old questions.

Page 5

Don't let yourself get overwhelmed with questions; just take it easy.

Page 5

" $\phi(\psi x)$ ": Suppose we are given a function of a subject-predicate proposition and we try to explain the way the function refers to the proposition by saying: The function only relates immediately to the subject of the subject-predicate proposition, and what signifies is the logical product of this relation and the subject-predicate propositional sign. Now if we say this, it can be asked: If you can explain the

Page Break 6

proposition like that, then why not give an analogous explanation of what it stands for? Namely: "It is not a function of a subject-predicate fact but the logical product of such a fact and of a function of its subject"? Must not the objection to the latter explanation hold against the former too?

21.9.14.

Page 6

Now it suddenly seems to me in some sense clear that a property of a situation must always be internal.

Page 6

$\phi a, \psi b, aRb$. It could be said that the situation aRb always has a certain property, if the first two propositions are true.

Page 6

When I say: It is good for p to be the case, then this must be good *in itself*.

Page 6

It now seems clear to me that there cannot be functions of situations.

23.9.14.

Page 6

It could be asked: How can the situation p have a property if it turns out that the situation does not hold at all?

24.9.14.

Page 6

The question how a correlation of relations is possible is identical with the problem of truth.

25.9.14.

Page 6

For the latter is identical with the question how the correlation of situations is possible (one that signifies and one that is signified).

Page 6

It is only possible by means of the correlation of the components; the correlation between names and things named gives an example. (And it is clear that a correlation of relations too takes place somehow.)

| aRb |; | a b |; p = aRb Def

Here a simple sign is correlated with a situation.

Page 6

What is the ground of our--certainly well founded--confidence that we shall be able to express any sense we like in our two-dimensional script?

27.9.14.

Page 6

A proposition can express its sense *only* by being the logical portrayal of it.

Page Break 7

Page 7

The similarity between these signs is striking:

"aRb"

"aσR.Rσb".

29.9.14.

Page 7

The general concept of the proposition carries with it a quite general concept of the coordination of proposition and situation: The solution to all my questions must be *extremely* simple.

Page 7

In the proposition a world is as it were put together experimentally. (As when in the law-court in Paris a motor-car accident is represented by means of dolls, etc.†1) [Cf. 4.031.]

Page 7

This must yield the nature of truth straight away (if I were not blind).

Page 7

Let us think of hieroglyphic writing in which each word is a representation of what it stands for. Let us think also of the fact that *actual* pictures of situations can be *right* and *wrong*. [Cf. 4.016.]

Page 7



"": If the right-hand figure in this picture represents the man A, and the left-hand one stands for the man B, then the whole might assert, e.g.: "A is fencing with B". The proposition in picture-writing can be true and false. It has a sense independent of its truth or falsehood. It must be possible to demonstrate everything essential by considering this case.

Page 7

It can be said that, while we are not certain of being able to turn all situations into pictures on paper, still we are certain that we can portray all *logical* properties of situations in a two-dimensional script.

Page 7

This is still very much on the surface, but we are on good ground.

30.9.14.

Page 7

It can be said that in our picture the right-hand figure is a representation of something and also the left-hand one, *but* even if this were not the case, their relative position could be a representation of something. (Namely a relation.)

Page Break 8

Page 8

A picture can present relations that do not exist! How is that possible?

Page 8

Now once more it looks as if all relations must be logical in order for their existence to be guaranteed by that of the sign.

2.10.14.

Page 8

What connects a and c in "aRb.bSc" is not the sign "." but the occurrence of the same letter "b" in the two simple sentences.

Page 8

We can say straight away: Instead of: this proposition has such and such a sense: this proposition represents such and such a situation. [See 4.031.]

Page 8

It portrays it logically.

Page 8

Only in this way can *the proposition* be true or false: It can only agree or disagree with reality by being a *picture* of a situation. [See 4.06.]

3.10.14.

Page 8

The proposition is a picture of a situation only in *so far* as it is logically articulated. (A simple-non-articulated-sign can be neither true nor false.) [Cf. 4.032.]

Page 8

The *name* is *not* a picture of the thing named!

Page 8

The proposition *only says something in so far* as far as it is a *picture*! [See 4.03.]

Page 8

Tautologies say nothing, they are not pictures of situations: they are themselves logically completely neutral. (The logical product of a tautology and a proposition says neither more nor less than the latter by itself.) [See 4.462 and 4.463.]

4.10.14.

Page 8

It is clear that "xRy" can contain the signifying element of a relation even if "x" and "y" do not stand for anything. And in that case the relation is the only thing that is signified in that sign.

Page 8

But in that case,†1 how is it possible for "kilo" in a code to mean: "I'm all right"? Here surely a *simple sign* does assert something and is used to give information to others.--

Page 8

For can't the *word* "kilo", with that meaning, be true or false?

Page Break 9

5.10.14.

Page 9

At any rate it is surely possible to correlate a simple sign with the sense of a sentence.--

Page 9

Logic is interested only in reality. And thus in sentences ONLY in so far as they are *pictures* of reality.

Page 9

But how CAN a SINGLE *word* be true or false? At any rate it cannot express the *thought* that agrees or does not agree with reality. That *must* be articulated.

Page 9

A single word cannot be true or false in *this* sense: it cannot agree with reality, or the opposite.

6.10.14.

Page 9

The general concept of two complexes of which the one can be the logical picture of the other, and so in one sense *is* so.

Page 9

The agreement of two complexes is obviously *internal* and for that reason cannot be expressed but can only be shewn.

Page 9

"p" is true, says nothing else but p.

Page 9

"p' is true" is--by the above--only a pseudo-proposition like all those connexions of signs which apparently say something that can only be shewn.

7.10.14.

Page 9

If a proposition ϕa is given, then all its logical functions ($\sim\phi a$, etc.) are *already* given with it! [Cf. 5.442.]

Page 9

Complete and incomplete portrayal of a situation. (Function plus argument is portrayed by function plus argument.)

Page 9

The expression "not further analysable" too is one of those which, together with "function", "thing" etc. are on the Index; but how does what we try to express by means of it get *shewn*?

Page 9

(Of course it cannot be said either of a thing or of a complex that it is not further analysable.)

9.10.14.

Page 9

If there were such a thing as an immediate correlation of relations, the question would be: How are the things that stand in these relations correlated with one another in this case? Is there such a thing as a direct correlation of relations without consideration of their *direction*?

Page Break 10

Page 10

Are we misled into assuming "relations between relations" merely through the apparent analogy between the expressions:

"relations between things"
and "relations between relations"?

Page 10

In all these considerations I am somewhere making some sort of FUNDAMENTAL MISTAKE.

Page 10

The question about the possibility of existence propositions does not come in the middle but at the very first beginning of logic.

Page 10

All the problems that go with the Axiom of Infinity have already to be solved in the proposition " $(\exists x)x = x$ ".
[Cf. 5.535.]

10.10.14.

Page 10

One often makes a remark and only later sees *how* true it is.

11.10.14.

Page 10

Our difficulty now lies in the fact that to all appearances analysability, or its opposite, is not reflected in language. That is to say: We can *not*, as it seems, gather from language alone whether for example there are real subject-predicate facts or not. But how COULD we *express* this fact or its opposite? *This must be shewn.*

Page 10

But suppose that we did not bother at all about the question of analysability? (We should then work with signs that do not stand for anything but merely *help* to express by means of their logical properties.) For even the unanalysed proposition mirrors logical properties of its meaning. Suppose then we were to say: The fact that a proposition is further analysable is shewn in our further analysing it by means of definitions, and we work with it in every case exactly as if it were unanalysable.

Page 10

Remember that the "propositions about *infinite* numbers" are all represented by means of *finite* signs.

Page 10

But do we not--at least according to Frege's method--need 100 million signs in order to define the number 100,000,000? (Doesn't this depend on whether it is applied to classes or to things?)

Page 10

The propositions dealing with infinite numbers, like *all* propositions of logic, can be got by calculating the signs themselves (for at no point does a foreign element get added to the original primitive signs). So

Page Break 11

here, too, the signs must themselves possess all the logical properties of what they represent.

12.10.14.

Page 11

The trivial fact that a completely analysed proposition contains just as many names as there are things contained in its reference; this fact is an example of the all-embracing representation of the world through language.

Page 11

It would be necessary to investigate the definitions of the cardinal numbers more exactly in order to understand the real sense of propositions like the Axiom of Infinity.

13.10.14.

Page 11

Logic takes care of itself; all we have to do is to look and see how it does it. [Cf. 5.473.]

Page 11

Let us consider the proposition: "there is a class with only one member". Or, what comes to the same thing, the proposition:

$$(\exists \phi) : (\exists x) : \phi x : \phi y . \phi z . \dot{E}_{y,z} y = z$$

Page 11

If we take " $(\exists x)x = x$ " it might be understood to be tautological since it could not get written down at all if it were false, but here! *This* proposition can be investigated in place of the Axiom of Infinity.

Page 11

I know that the following sentences as they stand are nonsensical: Can we speak of numbers if there are only things? I.e. if for example the world only consisted of one thing and of nothing else, could we say that there was ONE thing? Russell would probably say: If there is one thing then there is also a function $(\exists x) \overset{\Delta}{\xi} = x$. But!---

Page 11

If this function does not do it then we can only talk of 1 if there is a material function which is satisfied only by one argument.

Page 11

How is it with propositions like:

$$(\exists \phi) . (\exists x) . \phi(x) .$$

and $(\exists \phi) . (\exists x) . \sim \phi(x) .$

Is one of these a tautology? Are these propositions of some science, i.e. are they *propositions* at all?

Page 11

But let us remember that it is the *variables* and *not* the sign of generality that are characteristic of logic.

14.10.14.

Page 11

For is there such a thing as a science of completely generalized propositions? This sounds extremely improbable.

Page Break 12

Page 12

This is clear: If there are completely generalized *propositions*, then their sense does not depend on any arbitrary formation of signs! In that case, however, such a connexion of signs can represent the world only by means of its own logical properties, i.e. it can not be false, and not be true. So there are no completely generalized propositions. But now the application)

Page 12

But now the propositions: " $(\exists \phi, x) . \phi(x)$ "
and " $\sim (\exists \phi, x) . \phi(x)$ ".

Which of these is tautological, which contradictory?

Page 12

We keep on needing a comparative arrangement of propositions standing in internal relations. This book might well be equipped with diagrams.

Page 12

(The tautology *shews* what it appears to *say*, the contradiction *shews* the *opposite* of what it appears to say.)

Page 12

It is clear that we can form all the completely general propositions that are possible at all as soon as we are merely given *a language*. And that is why it is scarcely credible that such connexions of signs should really say anything about the world. On the other hand, however, this gradual transition from the elementary proposition to the completely general one!

We can say: The completely general propositions can all be formed *a priori*.

15.10.14.

Yet it does *not* look as if the mere existence of the forms contained in " $(\exists x, \phi). \phi(x)$ " could *by itself* determine the truth or falsehood of this proposition! So it does not appear *unthinkable* that, e.g., the negation of no elementary proposition should be true. But would not this statement itself touch the *SENSE of negation*?

Obviously we can conceive every quite general proposition as the affirmation or negation of the existence of some kind of facts. But does this not hold of all propositions?

Every connexion of signs which appears to say something about its own sense is a pseudo-proposition (like all propositions of logic).

The proposition is supposed to give a logical model of a situation. It can surely only do this, however, because objects have been arbitrarily correlated with its elements. Now if this is not the case in the

quite general proposition, then it is difficult to see how it should represent anything outside itself.

In the proposition we--so to speak--arrange things *experimentally*, as they do *not* have to be in reality; but we cannot make any *unlogical* arrangement, for in order to do that we should have to be able to get outside logic in language.--But if the quite general proposition contains *only* "logical constants", then it cannot be anything more to us than--simply--a logical structure, and cannot do anything more than shew us its own logical properties. If there are quite general propositions--*what* do we arrange experimentally in them? [Cf. 4.031 and 3.03.]

When one is frightened of the truth (as I am now) then it is never the *whole* truth that one has an inkling of.

Here I regarded the relations of the elements of the proposition to their meanings as feelers, so to say, by means of which the proposition is in contact with the outer world; and the generalization of a proposition is in that case like the drawing in of feelers; until finally the completely general proposition is quite isolated. But is this picture right? (Do I really draw a feeler in when I say $(\exists x). \phi x$ instead of ϕa ?) [Cf. 2.1515.]

16.10.14.

Now, however, it looks as if exactly the same grounds as those I produced to shew that " $(\exists x, \phi). \phi x$ " *could* not be false would be an argument shewing that " $\sim(\exists x, \phi). \phi x$ " could not be false; and here a fundamental mistake makes its appearance. For it is quite impossible to see why just the first proposition and not the second is supposed to be a tautology. But do not forget that the contradiction " $p. \sim p$ " etc. etc. cannot be true and is nevertheless itself a logical structure.

Suppose that no negation of an elementary proposition is true, has not "negation" another sense in this case than in the opposite case?

" $(\exists \phi): (x). \phi x$ "--of this proposition it appears almost certain that it is neither a tautology nor a contradiction. Here the problem becomes extremely sharp.

17.10.14.

If there are quite general propositions, then it looks as if such propositions were experimental combinations of "logical constants".(!)

But is it not possible to describe the whole world completely by means of completely general propositions? (The problem crops up on all sides.)

Yes, the world could be completely described by completely general propositions, and hence without using any sort of names or other denoting signs. And in order to arrive at ordinary language one would only need to

introduce names, etc. by saying, after an " $(\exists x)$ ", "and this x is A" and so on. [Cf. 5.526.]

Page 14

Thus it is possible to devise a picture of the world without saying what is a representation of what.

Page 14

Let us suppose, e.g., that the world consisted of the things A and B and the property F, and that $F(A)$ were the case and not $F(B)$. This world could also be described by means of the following propositions:

Page 14

$(\exists x,y).(\exists \phi).x \neq y.\phi x.\sim \phi y:\phi u.\phi z. \dot{E}_{u,z}.u = z$

$(\exists \phi).(\psi).\psi = \phi$

$(\exists x,y).(z).z = x \vee z = y$

And here one also needs propositions of the type of the last two, only in order to be able to identify the objects.

Page 14

From all this, of course, it follows that *there are completely general propositions!*

Page 14

But isn't the first proposition above enough: $(\exists x,y,\phi)\phi x.\sim \phi y.x \neq y$? The difficulty of identification can be done away with by describing the whole world in a single general proposition beginning: " $(\exists x,y,z... \phi,\psi... R,S...)$ " and now follows a logical product, etc.

Page 14

If we say " ϕ is a unit function and $(x).\phi x$ ", that is as much as to say: There is only one thing! (By this means we have *apparently* got round the proposition $(\exists x)(y).y = x$.)

18.10.14.

Page 14

My mistake obviously lies in a false conception of logical portrayal by the proposition.

Page 14

A statement cannot be concerned with the logical structure of the world, for in order for a statement to be possible at all, in order for a proposition to be CAPABLE of making SENSE, the world must already have just the logical structure that it has. The logic of the world is prior to all truth and falsehood.

Page Break 15

Page 15

Roughly speaking: before any proposition can make sense at all the *logical* constants must have reference. †1

19.10.14.

Page 15

The description of the world by means of propositions is only possible because what is signified is not its own sign! Application--.

Page 15

Light on Kant's question "How is pure mathematics possible?" through the theory of tautologies.

Page 15

It is obvious that we must be able to describe the structure of the world without mentioning any *names*. [Cf. 5.526.]

20.10.14.

Page 15

The proposition must enable us to see the logical structure of the situation that makes it true or false. (As a picture must shew the spatial relation in which the things represented in it must stand if the picture is correct (true).)

Page 15

The form of a picture might be called that in which the picture **MUST** agree with reality (in order to be capable of portraying it at all). [Cf. 2.17 and 2.18.]

Page 15

The first thing that the theory of logical portrayal by means of language gives us is a piece of information about the nature of the truth-relation.

Page 15

The theory of logical portrayal by means of language says--quite generally: In order for it to be possible that a proposition should be true or false--agree with reality or not--for this to be possible something in the proposition must be *identical* with reality. [Cf. 2.18.]

Page 15

What negates in "p" is not the "~" in front of the "p", but is what is common to all the signs that have the same meaning as "~p" in this notation; and therefore what is common in

$$\left. \begin{array}{l} \sim p \\ \sim \sim p \\ \sim p \vee \sim p \\ \sim p \cdot \sim p \\ \text{etc. etc.} \end{array} \right\}$$

and the same holds for the generality notation, etc.

[Cf. 5.512.]

Page Break 16

Page 16

Pseudo-propositions are such as, when analysed, turn out after all only to *shew* what they were supposed to say.

Page 16

Here we have a justification for the feeling that the proposition describes a complex in the kind of way that Russellian descriptions do: the proposition describes the complex by means of its logical properties.

Page 16

The proposition constructs a world by means of its logical scaffolding, and that is why we can actually see in the proposition how everything logical would stand if it were true: we can *draw conclusions* from a false proposition, etc. (In this way I can see that if " $(x, \phi). \phi x$ " were true, this proposition would contradict a proposition " ψa ".) [Cf 4.023.]

Page 16

The possibility of inferring completely general propositions from material propositions--the fact that the former are capable of standing in *meaningful* [[sic]] internal relations with the latter--shews that the completely general propositions are logical constructions from situations.

21.10.14.

Page 16

Isn't the Russellian definition of nought nonsensical? Can we speak of a class $\hat{x} (x \neq x)$ at all?--Can we speak of a class $\hat{x} (x = x)$ either? For is $x \neq x$ or $x = x$ a function of x ?--Must not 0 be defined by means of the hypothesis $(\exists \phi):(x) \sim \phi x$? And something analogous would hold of all other numbers. Now this throws light on the whole question about the existence of numbers of things.

$$\begin{aligned} 0 &= \hat{\alpha} \{ (\exists \phi):(x) \sim \phi x. \alpha = \hat{u}(\phi u) \} \text{ Def.} \\ 1 &= \hat{\alpha} \{ (\exists \phi)::(\exists x). \phi x: \phi y. \phi z. \hat{E}_{y,z} y = z: \alpha = \hat{u}(\phi u) \} \text{ Def.} \end{aligned}$$

Page 16

[The sign of equality in the curly brackets could be *avoided* if we were to write:

$$0 = \hat{u}(\phi u) \{ (x) \sim \phi x \cdot \dagger 1 \}$$

Page 16

The proposition must *contain* (and in this way shew) the *possibility of its truth*. But not more than the *possibility*. [Cf. 2.203 and 3.02 and 3.13.]

Page 16

By my definition of classes $(x). \sim \hat{x}(\phi x)$ is the assertion that $x(\phi x)$ is null and the definition of 0 is in that case $0 = \hat{\alpha} [(x). \sim \alpha]$ Def.

Page Break 17

Page 17

I thought that the possibility of the truth of the proposition ϕa was tied up with the fact $(\exists x, \phi). \phi x$. But it is impossible to see why ϕa should only be possible if there is another proposition of the same form. ϕa surely does not need any precedent. (For suppose that there existed only the two elementary propositions " ϕa " and " ψa " and

that " ϕa ", were false: Why should this proposition only make sense if " ψa " is true?)

22.10.14.

Page 17

There must be something in the proposition that is identical with its reference, but the proposition cannot be identical with its reference, and so there must be something in it that is *not* identical with the reference. (The proposition is a formation with the logical features of what it represents and with other features besides, but these will be arbitrary and different in different sign-languages.) So there must be different formations with the same logical features; what is represented will be one of these, and it will be the business of the representation to distinguish this one from other formations with the same logical features. (Since otherwise the representation would not be unambiguous.) This part of the representation (the assignment of names) must take place by means of arbitrary stipulations. Every proposition must accordingly contain features with arbitrarily determined references.

Page 17

If one tries to apply this to a completely generalized proposition, it appears that there is some fundamental mistake in it.

Page 17

The generality of the completely general proposition is accidental generality. It deals with all the things that there chance to be. And that is why it is a material proposition.

23.10.14.

Page 17

On the one hand my theory of logical portrayal seems to be the only possible one, on the other hand there seems to be an insoluble contradiction in it!

Page 17

If the completely generalized proposition is not completely dematerialized, then a proposition does not get dematerialized at all through generalization, as I used to think.

Page 17

Whether I assert something of a particular thing or of all the things that there are, the assertion is equally material.

Page Break 18

Page 18

"All things"; that is, so to speak, a description taking the place of "a and b and c".

Page 18

Suppose our signs were just as indeterminate as the world they terror?

Page 18

In order to recognize the sign in the sign we have to attend to the use. [Cf. 3.326.]

Page 18

If we were to try and express what we express by means of " $(x).\phi x$ " by prefixing an index to " ϕx ", e.g., like this: "Gen. ϕx ", it would not be adequate (we should not know what was being generalized).

Page 18

If we tried to shew it by means of an index to the "x", e.g., like this: $\phi(x_G)$, it would still not be adequate (in this way we should not know the scope of generality).

Page 18

If we thought of trying to do it by inserting a mark in the empty argument places, e.g., like this: " $(G,G).\psi(G,G)$ " it would not be adequate (we could not settle the identity of the variables).

Page 18

All these methods of symbolizing are inadequate *because they do not have the necessary logical properties*. All those collections of signs lack the power to portray the requisite sense-in the proposed way. [Cf. 4.0411.]

24.10.14.

Page 18

In order to be able to frame a statement at all, we must--in some sense--know how things stand if the statement is true (and that is just what we portray). [Cf. 4.024.]

Page 18

The proposition *expresses* what I do not know; but what I must know in order to be able to say it at all, *I shew in it*.

Page 18

A definition is a tautology and shews internal relations between its two terms!

Page 18

But why do you never investigate an individual particular sign in order to find out how it is a logical portrayal?

Page 18

The completely analysed proposition must image its reference.

Page 18

We might also say that our difficulty starts from the completely generalized proposition's not appearing to be complex.

Page 18

It does not appear, like all other propositions, to consist of arbitrarily symbolizing component parts which are united in a logical form. It appears not to HAVE a form but itself to be a form complete in itself.

Page Break 19

Page 19

With the logical constants one need never ask whether they exist, for they can even *vanish!*

Page 19

Why should " $\phi(\hat{x})$ " not image how $(x).\phi x$ is the case? Doesn't it all depend here *only* on *how*--in what kind of way--that sign images something?

Page 19

Suppose that I wanted to represent four pairs of men fighting; could I not do so by representing only one and saying: "That is how they all four look"? (By means of this appendix I determine the kind of representation.) (Similarly I represent $(x).\phi x$ by means of " $\phi(\hat{x})$ ".)

Page 19

Remember that there are no hypothetical internal relations. If a structure is given and a structural relation to it, then there must be another structure with that relation to the first one. (This is involved in the nature of structural relations.)

Page 19

And this speaks for the correctness of the above remark: it stops it from being--an evasion.

26.10.14.

Page 19

So it looks as if the logical *identity* between sign and things signified were not necessary, but only *an* internal, *logical*, relation between the two. (The holding of such a relation incorporates in a certain sense the holding of a kind of fundamental--internal--identity.)

Page 19

The point is only that the logical part of what is signified should be completely determined just by the logical part of the sign and the method of symbolizing: sign and method of symbolizing *together* must be logically identical with what is signified.

Page 19

The sense of the proposition is what it images. [Cf. 2.221.]

27.10.14.

Page 19

" $x = y$ " is not a propositional form. (Consequences.)

Page 19

It is clear that " aRa " would have the same reference as " $aRb.a = b$ ". So we can make the pseudo-proposition " $a = b$ " disappear by means of a completely analysed notation. The best proof of the correctness of the above remark.

Page 19

The difficulty of my theory of logical portrayal was that of finding a connexion between the signs on paper and a situation outside in the world.

Page Break 20

Page 20

I always said that truth is a relation between the proposition and the situation, but could never pick out such a relation.

Page 20

The representation of the world by means of completely generalized propositions might be called the

impersonal representation of the world.

Page 20

How does the impersonal representation of the world take place?

Page 20

The proposition is a model of reality as we imagine it. (See 4.01.)

28.10.14.

Page 20

What the pseudo-proposition "There are n things" tries to express shews in language by the presence of n proper names with different references. (Etc.)

Page 20

What the completely general propositions describe are indeed in a certain sense structural properties of the world. Nevertheless these propositions can still be true or false. According as they *make sense* the world still has that permanent range.

Page 20

In the end the truth or falsehood of *every* proposition makes some difference to the general *structure* of the world. And the range which is left to its structure by the TOTALITY of all elementary propositions is just the one that is bounded by the completely general propositions. [Cf. 5.5262.]

29.10.14.

Page 20

For, if an elementary proposition is true, then at any rate *one more* elementary proposition is true, and conversely. [See 5.5262.]

Page 20

In order for a proposition to be true it must first and foremost be *capable* of truth, and that is all that concerns logic.

Page 20

The proposition must shew what it is trying to say.--Its relation to its reference must be like that of a description to its subject.

Page 20

The logical form of the situation, however, cannot be described.--[Cf. 4.12 and 4.121.]

Page 20

The internal relation between the proposition and its reference, the method of symbolizing is the system of co-ordinates which projects the situation into the proposition. The proposition corresponds to the fundamental co-ordinates.

Page 20

We might conceive two co-ordinates a_P and b_P as a proposition stating that the material point P is to be found in the place (ab) . For

Page Break 21

this statement to be possible the co-ordinates a and b must really determine a place. For a statement to be possible the logical coordinates must really determine a logical place!

Page 21

(The subject-matter of general propositions is really the world; which makes its appearance in them by means of a logical description.--And that is why the world does not really occur in them, just as the subject of the description does not occur in it.)

Page 21

The fact that in a certain sense the logical form of p must be present even if p is not the case, shews symbolically through the fact that " p " occurs in " $\sim p$ ".

Page 21

This is the difficulty: How can there be such a thing as the form of p if there is no situation of this form? And in that case, what does this form really consist in?

Page 21

There are no such things as analytic *propositions*.

30.10.14.

Page 21

Could we say: In " $\sim\phi(x)$ " " $\phi(x)$ " images how things are *not*?

Page 21

Even in a picture we could represent a negative fact by representing what is *not* the case.

Page 21

If, however, we admit these methods of representation, then what is really characteristic of the relation of *representing*?

Page 21

Can't we say: It's just that there are different logical co-ordinate-systems!

Page 21

There are different ways of giving a representation, even by means of a picture, and what represents is not merely the sign or picture but also the method of representation. *What is common to all representation is that they can be right or wrong, true or false.*

Page 21

Then--picture *and way of representing* are completely outside what is represented!

Page 21

The two together are true or false, namely *the picture, in a particular way*. (Of course this holds for the elementary proposition tool)

Page 21

Any proposition can be negated. And this shews that "true" and "false" mean the same for all propositions. (This is of the greatest possible importance.) (In contrast to Russell.)

Page Break 22

Page 22

The reference of the proposition must be fixed, as conning or contradicting it, through it *together with its method of representation*. [Cf. 4.023.]

Page 22

In logic there is no side by side, there cannot be any classification. [See 5.454.]

31.10.14.

Page 22

A proposition like " $(\exists x, \phi). \phi x$ " is just as complex as an elementary one. This comes out in our having to mention " ϕ " and " x " *explicitly* in the brackets. The two stand--independently--in symbolizing relations to the world, just as in the case of an elementary proposition " $\psi(a)$ ". [Cf. 5.5261.]

Page 22

Isn't it like this: The logical constants signalise the way in which the elementary forms of the proposition represent?

Page 22

The reference of the proposition must be fixed as confirming or contradicting it, by means of it and its way of representing. To this end it must be completely described by the proposition. [Cf. 4.023.]

Page 22

The way of representing does not portray; only the proposition is a picture.

Page 22

The way of representing determines how the reality has to be compared with the picture.

Page 22

First and foremost the elementary propositional form must portray; all portrayal takes place through it.

1.11.14.

Page 22

We readily confuse the representing relation which the proposition has to its reference, and the truth relation. The former is different for different propositions, the latter is one and the same for all propositions.

Page 22

It looks as if " $(x, \phi). \phi x$ " were the form of a fact $\phi a. \psi b. \theta c$ etc. (Similarly $(\exists x). \phi x$ would be the form of ϕa , as I actually thought.)

Page 22

And this must be where my mistake is.

Page 22

Examine the elementary proposition: What is the form of " ϕa " and how is it related to " $\sim \phi(a)$ "?

Page 22

That precedent to which we should always like to appeal must be involved in the sign itself. [Cf. 5.525.]

Page Break 23

Page 23

The logical form of the proposition must already be given by the forms of its component parts. (And these have to do only with the *sense* of the propositions, not with their truth and falsehood.)

Page 23

In the form of the subject and of the predicate there already lies the possibility of the subject-predicate proposition, etc.; but fair enough--nothing about its truth or falsehood.

Page 23

The picture has whatever relation to reality it does have. And the point is how it is supposed to represent. The same picture will agree or fail to agree with reality according to how it is supposed to represent.

Page 23

Analogy between proposition and description: *The complex which is congruent with this sign.* (Exactly as in representation in a map.)

Page 23

Only it just cannot be *said* that this complex is congruent with that (or anything of the kind), but this shews. And for this reason the description assumes a different character. [Cf. 4.023.]

Page 23

The method of portrayal must be completely determinate before we can compare reality with the proposition at all in order to see whether it is true or false. The method of comparison must be given me before I can make the comparison.

Page 23

Whether a proposition is true or false is something that has to appear.

Page 23

We must however know in advance *how* it will appear.

Page 23

That two people are not fighting can be represented by representing: them as not fighting and also by representing them as fighting and saying that the picture shews how things are *not*. We *could* represent by means of negative facts just as much as by means of positive ones----. However, all we want is to investigate the principles of representing *as such*.

Page 23

The proposition "'p' is true" has the same reference as the logical product of 'p', and a proposition "'p'" which describes the proposition 'p', and a correlation of the components of the two propositions.--The internal relations between proposition and reference are portrayed by means of the internal relations between 'p' and "'p'". (Bad remark.)

Page 23

Don't get involved in partial problems, but always take flight to where there is a free view over the whole *single* great problem, even if this view is still not a clear one.

Page Break 24

Page 24

'A situation is thinkable' ('imaginable') means: We can make ourselves a picture of it. [3.001.]

Page 24

The proposition must determine a logical place.

Page 24

The existence of this logical place is guaranteed by the existence of the component parts alone, by the existence of the significant proposition.

Page 24

Supposing there is no complex in the logical place, there is one then that is: not in that logical place. [Cf. 3.4.]
2.11.14.

Page 24

In the tautology the conditions of agreement with the world (the truth-conditions)--the representing relations--cancel one another out, so that it does not stand in any representing relation to reality (says nothing). [Cf. 4.462.]

Page 24

$a = a$ is not a tautology in the same sense as $p \supset p$.

Page 24

For a proposition to be true does not consist in its having a *particular* relation to reality but in its really *having* a particular relation.

Page 24

Isn't it like this: the false proposition makes sense like the true and independently of its falsehood or truth, but it has no reference? (Is there not here a better use of the word "reference"?)

Page 24

Could we say: As soon as I am given subject and predicate I am given a relation which will *exist* or not *exist* between a subject-predicate proposition and its reference. As soon as I really know subject and predicate, I can also know about the relation, which is an indispensable presupposition even for the case of the subject-predicate proposition's being false.

3.11.14.

Page 24

In order for it to be possible for a negative situation to exist, the picture of the positive situation must exist. [Cf. 5.5151.]

Page 24

The knowledge of the representing relation *must* be founded only on the knowledge of the component parts of the situation!

Page 24

Then would it be possible to say: the knowledge of the subject predicate proposition and of subject and predicate gives us the knowledge of an internal relation, etc.?

Page 24

Even this is not strictly correct since we do not need to know any particular subject or predicate.

Page Break 25

Page 25

It is *evident* that we feel the elementary proposition as the picture of a situation.--How is this? [Cf. 4.012.]

Page 25

Must not the possibility of the representing relation be given by the proposition *itself*?

Page 25

The proposition *itself* sunders what is congruent with it from what is not congruent.

Page 25

For example: if the proposition is given, and congruence, then the proposition is true if the situation is congruent with it. Or: the proposition is given and non-congruence; then the proposition is true if the situation is not congruent with it.

Page 25

But how is congruence or non-congruence or the like given us?

Page 25

How can I be *told how* the proposition represents? Or can this not be *said* to me at all? And if that is so can I "*know*" it? If it was supposed to be said to me, then this would have to be done by means of a proposition; but the proposition could only shew it.

Page 25

What can be said can only be said by means of a proposition, and so nothing that is necessary for the understanding of *all* propositions can be said.

Page 25

That arbitrary correlation of sign and thing signified which is a condition of the possibility of the propositions, and which I found lacking in the completely general propositions, occurs there by means of the generality notation, just as in the elementary proposition it occurs by means of names. (For the generality notation does not belong to the *picture*.) Hence the constant feeling that generality makes its appearance quite like an argument. [Cf. 5.523.]

Page 25

Only a finished proposition can be negated. (And similarly for all ab-functions.)†1 [Cf. 4.064 and 4.0641.]

Page 25

The proposition is the logical picture of a situation.

Page 25

Negation refers to the *finished* sense of the negated proposition and not to its way of presenting. [Cf. 4.064 and 4.0641.]

Page 25

If a picture presents what-is-not-the-case in the forementioned way, this only happens through its presenting *that* which *is* not the case.

Page 25

For the picture says, as it were: "*This* is how it is *not*", and to the question "*How* is it not?" just the positive proposition is the answer.

Page Break 26

Page 26

It might be said: The negation refers to the very logical place which is determined by the negated proposition. [See 4.0641.]

Page 26

Only don't lose the solid ground on which you have just been standing!

Page 26

The negating proposition determines a *different* logical place from the negated proposition. [See 4.0641.]

Page 26

The negated proposition not only draws the boundary between the negated domain and the rest; it actually points to the negated domain.

Page 26

The negating proposition uses the logical place of the negated proposition to determine its own logical place. By describing the latter as the place that is outside the former. [See 4.0641.]

Page 26

The proposition is true when what it images exists.

4.11.14.

Page 26

How does the proposition determine the logical place?

Page 26

How does the picture present a situation?

Page 26

It is after all itself not the situation, which need not be the case at all.

Page 26

One name is representative of one thing, another of another thing, and they themselves are connected; in this way--like a *tableau vivant*--the whole images the situation. [Cf. 4.0311.]

Page 26

The logical connexion must, of course, be one that is possible as between the things that the names are representatives of, and this will always be the case if the names really are representatives of the things. N.B. that connexion is not a relation but only the *holding* of a relation.

5.11.14.

Page 26

In this way the proposition represents the situation--as it were off its own bat.

Page 26

But when I say: the connexion of the propositional components must be possible for the represented things--does this not contain the whole problem? How can a non-existent connexion between objects be possible?

Page 26

"The connexion must be possible" means: The proposition and the components of the situation must stand in a particular relation.

Page Break 27

Page 27

Then in order for a proposition to present a situation it is only necessary for its component parts to represent those of the situation and for the former to stand in a connexion which is possible for the latter.

Page 27

The propositional sign guarantees the possibility of the fact which it presents (not, that this fact is actually the case)--this holds for the general propositions too.

Page 27

For if the positive fact ϕa is given then so is the *possibility* of $(x).\phi x$, $\sim(\exists x).\phi x$, $\sim\phi a$ etc. etc. (All logical constants are already contained in the elementary proposition.) [Cf. 5.47.]

Page 27

That is how the picture arises.--

Page 27

In order to designate a logical place with the picture we must attach a way of symbolizing to it (the positive, the negative, etc.).

Page 27

We might, e.g., shew how *not* to fence by means of fencing puppets.

6.11.14.

Page 27

And it is just the same with this case as with $\sim\phi a$, although the picture deals with what *should* not happen instead of with what does not happen.

Page 27

The possibility of negating the negated proposition in its turn shews that what is negated is already a proposition and not merely the preliminary to a proposition. [See 4.0641.]

Page 27

Could we say; Here is the picture, but we cannot tell whether it is right or not until we know what it is supposed to say.

Page 27

The picture must now in its turn cast its shadow on the world.

7.11.14.

Page 27

Spatial and logical place agree in both being the possibility of an existence. [Cf. 3.411.]

8.11.14.

Page 27

What can be confirmed by experiment, in propositions about probability, cannot possibly be mathematics. [Cf. 5.154.]

Page 27

Probability propositions are abstracts of scientific laws. [Cf. 5.156.]

Page 27

They are generalizations and express an incomplete knowledge of those laws. [Cf. 5.156.]

Page Break 28

Page 28

If, e.g., I take black and white balls out of an urn I cannot say before taking one out whether I shall get a white or a black ball, since I am not well enough acquainted with the natural laws for that, but *all the same I do know* that if there are equally many black and white balls there, the numbers of black balls that are drawn will approach the number of white ones if the drawing is continued; I do know the natural laws as accurately as *this*. [Cf. 5.154]

9.11.14.

Page 28

Now what I know in probability statements are certain general properties of ungeneralized propositions of natural science, such as, e.g., their symmetry in certain respects, and asymmetry in others, etc. [Cf. 5.156.]

Page 28

Puzzle pictures and the seeing of situations. [Cf. 5.5423.]

Page 28

It has been what I should like to call my strong scholastic feeling that has occasioned my best discoveries.

Page 28

"Not p" and "p" contradict one another, both cannot be true; but I can surely express both, *both pictures exist*. They are to be found side by side.

Page 28

Or rather "p" and " $\sim p$ " are like a picture and the infinite plane outside this picture. (Logical place.)

Page 28

I can construct the infinite space outside only by using the picture to bound that space.

10.11.14.

Page 28

When I say "p is possible", does that mean that "p" makes sense? Is the former proposition about language, so that the existence of a propositional sign ("p") is essential for its sense? (In that case it would be quite unimportant.) But does it not rather try to say what " $p \vee \sim p$ " shews?

Page 28

Does not my study of sign language correspond to the study of the processes of thought, which philosophers

have always taken as so essential for philosophy of logic?--Only they always got involved in inessential psychological investigations, and there is an analogous danger with my method too. [See 4.1121.]

11.11.14.

Page 28

Since "a = b" is not a proposition, nor "x = y" a function, a "class $\hat{x} (x = x)$ " is a chimera, and so equally is the so-called null class. (One

Page Break 29

did indeed always have the feeling that wherever $x = x$, $a = a$, etc. were used in the construction of sentences, in all such cases one was only getting out of a difficulty by means of a swindle; as though one said "a exists" means " $(\exists x)x = a$ ".)

Page 29

This is wrong: since the definition of classes itself guarantees the existence of the real functions.

Page 29

When I appear to assert a function of the null class, I am saying that this function is true of all functions that are null--and I can say that even if *no* function is null.

Page 29

Is $x \neq x$. $\equiv_x \phi x$ identical with
 $(x) \sim \phi x$? Certainly!

Page 29

The proposition points to the possibility that such and such is the case.

12.11.14.

Page 29

The negation is *a description* in the same sense as the elementary proposition itself.

Page 29

The truth of the proposition might be called possible, that of a tautology certain, and that of a contradiction impossible. Here we already get the hint of a gradation that we need in the probability calculus. [Cf. 4.464.]

Page 29

In the tautology the elementary proposition does, of course, still portray, but it is so loosely connected with reality that reality has unlimited freedom. Contradiction in its turn imposes such constraints that no reality can exist under them.

Page 29

It is as if the logical constants projected the picture of the elementary proposition on to reality--which may then accord or not accord with this projection.

Page 29

Although all logical constants must already occur in the simple proposition, its own peculiar proto-picture *must* surely also occur in it whole and undivided.

Page 29

Then is the picture perhaps not the simple proposition, but rather its prototype which must occur in it?

Page 29

Then, this prototype is not actually a proposition (though it has the Gestalt of a proposition) and it might correspond to Frege's "assumption".

Page Break 30

Page 30

In that case the proposition would consist of proto-pictures, which were projected on to the world.

13.11.14.

Page 30

In this work more than any other it is rewarding to keep on looking at questions, which one considers solved, from another quarter, as if they were unsolved.

14.11.14.

Page 30

Think of the representation of *negative* facts by means of models. E.g.: two railway trains must not stand on the rails in such-and-such a way. The proposition, the picture, the model are--in the negative sense--like a solid body restricting the freedom of movement of others; in the positive sense, like the space bounded by solid substance, in which there is room for a body. [Cf. 4.463.]

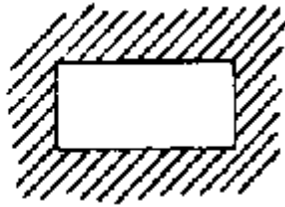

This image is *very* clear and must lead to the solution.

15.11.14.

Page 30

Projection of the picture on to reality.

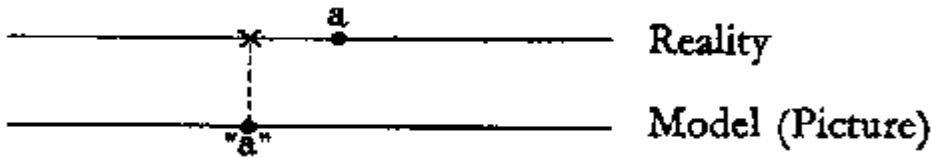

(Maxwell's method of mechanical models.)

Page 30

Don't worry about what you have already written. Just keep on beginning to think afresh as if nothing at all had happened yet.

Page 30

That shadow which the picture as it were casts upon the world: How am I to get an exact grasp of it?

Page 30

Here is a deep mystery.

Page 30

It is the mystery of negation: This is not how things are, and yet we can say *how* things are *not*.--

Page 30

For the proposition is only the *description* of a situation. (But this is all still only on the surface.) [Cf. 4.023.]

Page Break 31

Page 31

A single insight at the start is worth more than ever so many somewhere in the middle.

16.11.14

Page 31

The introduction of the sign "0" in order to make the decimal notation possible: the logical significance of this procedure.

17.11.14.

Page 31

Suppose " ϕa " is true: what does it mean to say $\sim\phi a$ is possible? (ϕa is itself equivalent in meaning with $\sim(\sim\phi a)$.)

18.11.14.

Page 31

It is all simply a matter of the existence of the logical place. But what the devil is this "logical place"?!

19.11.14.

Page 31

The proposition and the logical co-ordinates: that is the logical place. [Cf. 3.41.]

20.11.14.

Page 31

The reality that corresponds to the sense of the proposition can surely be nothing but its component parts, since we are surely *ignorant of everything* else.

Page 31

If the reality consists in anything else as well, this can at any rate neither be denoted nor expressed; for in the first case it would be a further component, in the second the expression would be a proposition, for which the same problem would exist in turn as for the original one.

Page 31

What do I really know when I understand the sense of " ϕa " but do not know whether it is true or false? In that case I surely know no more than $\phi a \vee \sim\phi a$; and that means I *know* nothing.

Page 31

As the realities corresponding to the sense of a proposition are only its component parts, the logical co-ordinates too can only refer to these.

22.11.14.

Page 31

At this point I am again trying to express something that cannot be expressed.

23.11.14.

Page 31

Although the proposition must only point to a region of logical space, still the whole of logical space must *already* be given by means of it.--

Page Break 32

Otherwise *new* elements--and in co-ordination--would keep on being introduced by means of negation, disjunction, etc.; which, of course, must not happen. [Cf. 3.42.]

24.11.14.

Page 32

Proposition and situation are related to one another like the yardstick and the length to be measured.

Page 32

That the *proposition* " ϕa " can be inferred from the *proposition* " $(x).\phi x$ " shews how generality is present even in the *sign* " $(x).\phi x$ ".

Page 32

And the same thing, of course, holds for any generality notation.

Page 32

In the proposition we hold a proto-picture up against reality.

Page 32

(When investigating negative facts one keeps on feeling as if they presupposed the existence of the propositional sign.)

Page 32

Must the sign of the negative proposition be constructed by means of the sign of the positive one? (I believe so.)

Page 32

Why shouldn't one be able to express the negative proposition by means of a negative fact? It's as if one were to take the space outside the yardstick as the object of comparison instead of the yardstick. [Cf. 5.5151.]

Page 32

How does the *proposition* " $\sim p$ " really contradict the *proposition* " p "? The internal relations of the two signs must mean contradiction.

Page 32

Of course it must be possible to ask whenever we have a negative proposition: *What* is it that is *not* the case? But the answer to this is, of course, in its turn only a proposition. (This remark incomplete.)

25.11.14.

Page 32

That negative state of affairs that serves as a sign can, of course, perfectly well exist without a proposition that in turn expresses it.

Page 32

In investigating these problems it's constantly as if they were already solved, an illusion which arises from the fact that the problems often quite disappear from our view.

Page 32

I can see that $\sim\phi a$ is the case just by observing $\phi z x q$  and a.

Page 32

The question here is: Is the positive fact primary, the negative secondary, or are they on the same level? And if so, how is it with the facts $p \vee q$, $p \supset q$, etc.? Aren't these on the same level as $\sim p$? But then

Page Break 33

must not *all facts* be on the same level? The question is really this: fire there facts besides the positive ones? (For it is difficult not to confuse what is not the case with what *is* the case instead of it.)

Page 33

It is clear that all the ab-functions are only so many different methods for measuring reality.--And certainly the methods of measurement by means of p and ~p have some special advantage over all others.--

Page 33

It is the *dualism*, positive and negative facts, that gives me no peace. For such a dualism can't exist. But how to get away from it?

Page 33

All this would get solved of itself if we understood the nature of the proposition.

26.11.14.

Page 33

If all the positive statements about a thing are made, aren't all the negative ones already made too? And that is the whole point.

Page 33

The dualism of positive and negative that I feared does not exist, for (x).φx, etc. etc. are neither positive nor negative.

Page 33

If the positive proposition does not *have* to occur in the negative, mustn't at any rate the proto-picture of the positive proposition occur in the negative one?

Page 33

By making a distinction--as we do in any possible notation--between ~aRb and ~bRa we presuppose in any notation a particular correlation between argument and argument place in the negative proposition; the correlation gives the prototype of the negated positive proposition.

Page 33

Then is that correlation of the components of the proposition by means of which nothing is yet *said* the real picture in the proposition?

Page 33

Doesn't my lack of clarity rest on a lack of understanding of the nature of relations?

Page 33

Can one negate a *picture*? No. And in this lies the difference between picture and proposition. The picture can serve as a proposition. But in that case something gets added to it which brings it about that now it *says* something. In short: I can only deny that the picture is right, but the *picture* I cannot deny.

Page 33

By my correlating the components of the picture with objects, it

Page Break 34

comes to represent a situation and to be right or wrong. (E.g., a picture represents the inside of a room, etc.)

27.11.14.

"~p" is true when p is false. So part of the true proposition "~p" is a false proposition. How can the mere twiddle "~" bring it into agreement with reality? We have, of course, already said that it is not the twiddle "~" alone but everything that is common to the different signs of negation. And what is common to all these must obviously proceed from the meaning of negation itself. And so in this way the sign of negation must surely mirror its own reference. [Cf. 5.512.]

28.11.14.

Page 34

Negation combines with the ab-functions of the elementary proposition. And the logical functions of the elementary proposition must mirror their reference, just as much as all the others.

29.11.14.

Page 34

The ab-function does not stop short of the elementary proposition but penetrates it.

Page 34

What *can* be shewn cannot be said. [4.1212.]

Page 34

I believe that it would be possible wholly to exclude the sign of identity from our notation and always to indicate identity merely by the identity of the signs (and conversely). In that case, of course, $\phi(a,a)$ would not be a special case of $(x,y).\phi(x,y)$, and ϕa would not be a special case of $(\exists x,y).\phi x.\phi y$. But then instead of $\phi x.\phi y \supset_{x,y} x = y$ one could simply write $\sim(\exists x,y).\phi x.\phi y$. [Cf. 5.53 and 5.533]

Page 34

By means of this notation the pseudo-proposition $(x)x = a$ or the like would lose all appearances of justification. [Cf. 5.534.]

1.12.14.

Page 34

The proposition says as it were: This picture cannot (or can) present a situation in this way.

2.12.14.

Page 34

It all depends on settling what distinguishes the proposition from the mere picture.

4.12.14.

Page 34

Let us look at the identity $\sim\sim p = p$: this, together with others, determines the sign for p , since it says that there is something that "p"

Page Break 35

and " $\sim\sim p$ " have in common. Through this that sign acquires properties which mirror the fact that double negation is an affirmation.

5.12.14.

Page 35

How does " $p \vee \sim p$ " say nothing?

6.12.14.

Page 35

Newtonian mechanics brings the description of the world into a unitary form. Let us imagine a white surface with irregular black spots on it. We now say: Whatever sort of picture arises in this way, I shall always be able to approximate as close as I like to its description by covering the surface with a suitably fine square network and saying of each square that it is white or is black. In this way I shall have brought the description of this surface into a unitary form. This form is arbitrary, for I could with equal success have used a triangular or hexagonal net. It may be that the description by means of a triangular net would have been simpler, i.e. that we could have given a more accurate description of the surface with a coarser triangular net than with a finer square one (or vice versa), etc. Different systems of describing the world correspond to the different nets. Mechanics determines the form of description of the world by saying: All propositions in a description of the world must be capable of being got in a given way from a number of given propositions--the axioms of mechanics. In this way it supplies the stones for building up natural science and says: Whatever building you want to erect you must construct it somehow with these and only these stones.

Page 35

Just as it must be possible to write down any arbitrary number by means of the system of numbers, so it must be possible to write down any arbitrary proposition of physics by means of the system of mechanics.

Page 35

[6.341.]

Page 35

And here we see the relative position of logic and mechanics.

Page 35

(One might also allow the net to consist of a variety of figures.)

Page 35

The fact that a configuration like that mentioned above can be described by means of a net of a given form asserts nothing about the configuration (for this holds for any such configuration). What does characterize the configuration however is that it can be described by means of a particular net of a *particular* degree of fineness. In this way too it tells us nothing about the world that it can be described by means of Newtonian mechanics; but it does tell us something that it can be

Page Break 36

described by means of Newtonian mechanics in the way that it actually can. (This I have felt for a *long* time.)--It also

asserts something about the world, that it can be described more simply by means of one mechanics than by means of another.

Page 36

[Cf. 6.342.]

Page 36

Mechanics is *one* attempt to construct all the propositions that we need for the description of the world according to a *single* plan. (Hertz's invisible masses.) [Cf. 6.343.]

Page 36

Hertz's invisible masses are admittedly pseudo-objects.

7.12.14.

Page 36

The logical constants of the proposition are the conditions of its truth.

8.12.14.

Page 36

Behind our thoughts, true and false, there is always to be found a dark background, which we are only later able to bring into the light and express as a thought.

12.12.14.

Page 36

p. Taut = p, i.e. Taut says nothing. [Cf. 4.465.]

13.12.14.

Page 36

Does it exhaust the nature of negation that it is an operation cancelling itself? In that case χ would have to stand for negation if $\chi\chi p = p$, assuming that $\chi p \neq p$.

Page 36

This for one thing is certain, that according to these two equations χ can no longer express affirmation.

Page 36

And does not the capacity which these operations have of vanishing shew that they are logical?

15.12.14.

Page 36

It is obvious that we can introduce whatever we like as the written signs of the ab-function, the real sign will form itself automatically. And when this happens what properties will be formed of themselves?

Page 36

The logical scaffolding surrounding the picture (in the proposition) determines logical space. [Cf. 3.42.]

16.12.14.

Page 36

The proposition must reach out through the whole of logical space. [Cf. 3.42.]

Page Break 37

17.12.14.

Page 37

The signs of the ab-function are not material, otherwise they could not vanish. [Cf. 5.44 and 5.441.]

18.12.14.

Page 37

It must be possible to distinguish just as much in the real propositional sign as can be distinguished in the situation. This is what their identity consists in. [Cf. 4.04.]

20.12.14.

Page 37

In "p" neither more nor less can be recognized than in " \sim p".

Page 37

How can a situation agree with "p" and not agree with " \sim p"?

Page 37

The following question might also be asked: If I were to try to invent *Language* for the purpose of making myself understood to someone else, what sort of rules should I have to agree on with him about our expression?

23.12.14.

Page 37

A characteristic example for my theory of the significance of descriptions in physics: The two theories of

heat; heat conceived at one time as a stuff, at another time as a movement.

25.12.14.

Page 37

The proposition says something, is identical with: It has a particular relation to reality, *whatever this may be*. And if this *reality* is given and also that relation, then the sense of the proposition is known. " $p \vee q$ " has a different relation to reality from " $p \cdot q$ ", etc.

Page 37

The possibility of the proposition is, of course, founded on the principle of signs as GOING PROXY for objects. [Cf. 4.0312.]

Page 37

Thus in the proposition something has *something else* as its proxy.

Page 37

But there is also the *common cement*.

Page 37

My fundamental thought is that the logical constants are not proxies. That the *logic* of the fact cannot have anything as its proxy. [See 4.0312.]

29.12.14.

Page 37

In the proposition the name goes proxy for the object. [3.22.]

11.1.15.

Page 37

A yardstick does not say that an object that is to be measured is one yard long.

Page Break 38

Page 38

Not even when we know that it is supposed to serve for the measurement of this *particular* object.

Page 38

Could we not ask: What has to be added to that yardstick in order for it to *assert* something about the length of the object?

Page 38

(The yardstick without this addition would be the "assumption".)

15.1.15.

Page 38

The propositional sign " $p \vee q$ " is right if p is the case, if q is the case and if both are the case, otherwise it is wrong. This seems to be infinitely simple; and the solution will be *as* simple as this.

16.1.15.

Page 38

The proposition is correlated with a hypothetical situation.

Page 38

This situation is given by means of its description.

Page 38

The proposition is the description of a situation. [See 4.023.]

Page 38

As the description of an object describes it by its external properties, so the proposition describes the fact by its internal properties. [See 4.023.]

Page 38

The description is right if the object has the asserted property: the proposition is right if the situation has the internal properties given by the proposition.

17.1.15.

Page 38

The situation $p \cdot q$ *falls under* the proposition " $p \vee q$ ".

Page 38

On the analogy of the net for physics: although the spots are geometrical figures, all the same geometry can, of course, say nothing at all about their form and position. The net, however, is *purely* geometrical, all its properties can be given *a priori*. [See 6.35.]

18.1.15.

Page 38

The comparison between proposition and description is purely logical and for that reason *must* be carried farther.

20.1.15.

Page 38

How is it that *all* is a logical concept?

Page 38

How is it that *all* is a concept of form?

Page 38

How does it come about that *all* can occur in any proposition?

Page Break 39

Page 39

For that is the characteristic mark of the concept of a form.

Page 39

All APPEARS to be nearer to the content of the proposition than to the form.

Page 39

All: things, All: functions, All: relations: it is as if All were a connecting *term* between the concept of the thing, of functions, etc., and the individual thing, the individual functions.

Page 39

Generality is essentially connected with the elementary FORM.

Page 39

The key word--?

21.1.15.

Page 39

The transition from the general consideration of the propositional form: *infinitely difficult, fantastic*.

22.1.15.

Page 39

My *whole* task consists in explaining the nature of the proposition.

Page 39

That is to say, in giving the nature of all facts, whose picture the proposition *is*.

Page 39

In giving the nature of all being.

Page 39

(And here Being does not mean existing--in that case it would be nonsensical.)

23.1.15.

Page 39

Negation is an operation. [*Cf.* 5.2341.]

Page 39

An operation denotes an operation.

Page 39

Words are probes; some reach very deep; some only to a little depth.

Page 39

An operation, of course, does not say anything, only its result does; and this depends on its object. [*Cf.* 5.25.]

24.1.15.

Page 39

The logical pseudo-functions *are* operations.

Page 39

Only operations can vanish!

Page 39

The negative proposition excludes reality.

Page 39

How can the all-embracing world-mirroring logic make use of such special twiddles and manipulations? Only by all these being linked together to form one *infinitely* fine network, to form the great mirror. [5.511.]

Page Break 40

	25.1.15.
Page 40	
We can also say: $\sim p$ is false, when p is true.	29.1.15.
Page 40	
Language is articulated. [Cf. 3.141.]	7.2.15.
Page 40	
Musical themes are in a certain sense propositions. Knowledge of the nature of logic will for this reason lead to knowledge of the nature of music.	14.2.15.
Page 40	
If there were mathematical objects--logical constants--the proposition "I am eating five plums" would be a proposition of mathematics. And it is not even a proposition of applied mathematics.	
Page 40	
The proposition must describe its reference <i>completely</i> . [Cf. 4.023.]	4.3.15.
Page 40	
A tune is a kind of tautology, it is complete in itself; it satisfies itself.	5.3.15.
Page 40	
Mankind has always had an inkling that there must be a sphere of questions where the answers must-- <i>a priori</i> --be arranged symmetrically, and united into a complete regular structure. [See 5.4541.]	
Page 40	
(The older a word, the deeper it reaches.)	6.3.15.
Page 40	
The problems of negation, of disjunction, of true and false, are only reflections of the one great problem in the variously placed great and small mirrors of philosophy.	7.3.15.
Page 40	
Just as $\sim \xi$, $\sim \xi \vee \sim \xi$ etc. are the same function, so too are $\sim \eta \vee \eta$, $\eta \supset \eta$, etc. the same--that is, the tautological--function. Just as the others can be investigated, so can it--and perhaps with advantage.	8.3.15.
Page 40	
My difficulty is only an--enormous--difficulty of expression.	18.3.15.
Page 40	
It is clear that the closest examination of the propositional sign cannot yield what it asserts--what it can yield is what it is <i>capable</i> of asserting.	
Page Break 41	27.3.15.
Page 41	
The picture can replace a description.	29.3.15.
Page 41	
The law of causality is not a law but the form of a law. [Cf. 6.32.]	
Page 41	
"Law of causality" is a class name. And just as in mechanics--let us say--there are minimum laws--e.g., that of least action--so in physics there is A law of causality, a law of the causality form. [Cf. 6.321.]	
Page 41	
Just as men also had an inkling of the fact that there must be a "law of least action", before precisely knowing how it ran.	
Page 41	
(Here, as so often happens, the <i>a priori</i> turns out to be something purely logical.)	

Page 41	[Cf. 6.3211.]	3.4.15.
Page 41	The proposition is a measure of the world.	
Page 41	This is the picture of a process and is wrong. In that case how can it still be a picture of that process?	
Page 41	"a" <i>can</i> go proxy for a and "b" <i>can</i> go proxy for b when "a" stands in the relation "R" to "b": this is what that POTENTIAL internal relation that we are looking for consists in.	5.4.15.
Page 41	The proposition is not a blend of words. [See 3.141.]	11.4.15.
Page 41	Nor is a tune a blend of notes, as all unmusical people think. [Cf. 3.141.]	12.4.15.
Page 41	I <i>cannot</i> get from the nature of the proposition to the individual logical operations!!!	15.4.15.
Page 41	That is, I cannot bring out how far the proposition is the <i>picture</i> of the situation.	
Page 41	I am almost inclined to give up all my efforts.---- ----	16.4.15.
Page 41	Description is also, so to speak, an operation with the means of description as its basis, and with the described object as its result.	
Page Break 42		
Page 42	The sign "not" is the class of all negating signs.	17.4.15.
Page 42	The subjective universe.	
Page 42	Instead of performing the logical operations in the proposition upon its component propositions, we can correlate <i>marks</i> with these and operate with them. In that case a single propositional formation has correlated with it a constellation of marks which is connected with it in a most complicated way.	
Page 42	$(aRb, cSd, \phi e) ((p \vee q).r: \supset q.r. \equiv p \vee r)$	
Page 42	p q r	18.4.15.
Page 42	The transition from p to $\sim p$ is <i>not</i> what is characteristic of the operation of negation. (The <i>best proof</i> of this: negation also leads from $\sim p$ to p.)-----.	19.4.15.
Page 42	What is mirrored in language I cannot use language to express. [Cf. 4.121.]	23.4.15.
Page 42	We do not believe <i>a priori</i> in a law of conservation, we <i>know a priori</i> the possibility of its logical form. [6.33.]	
Page 42	All those propositions which are known <i>a priori</i> , like the principle of sufficient reason, of continuity in	

nature, etc., etc., all these are *a priori* insights relating to the possible ways of forming the propositions of natural science. [Cf. 6.34.]

Page 42

"Ockham's razor" is, *of course*, not an arbitrary rule or one justified by its practical success. What it says is that unnecessary sign-units mean nothing. [See 5.47321.]

Page 42

It is clear that signs fulfilling the same purpose are logically identical. The purely logical thing just *is* what *all* of these are capable of accomplishing [Cf. 5.47321.]

24.4.15.

Page 42

In logic (mathematics) process and result are equivalent. (Hence no surprises.) [6.1261.]

25.4.15.

Page 42

Since language stands in *internal* relations to the world, *it* and these relations determine the logical possibility of facts. If we have a significant

Page Break 43

sign it must stand in a particular internal relation to a structure. Sign and relation determine unambiguously the logical form of the thing signified.

Page 43

But cannot any so-called thing be correlated in one and the same way with any other such?

Page 43

It is, for example, quite clear that the separate words of language are--experienced and--used as logically equivalent units.

Page 43

It always seems as if there were something that one *can regard as a thing*, and *on the other hand* real simple things.

Page 43

It is clear that neither a pencil-stroke nor a steamship is simple. Is there really a logical equivalence between these two?

Page 43

"Laws" like the law of sufficient reason, etc. deal with the network not with what the network describes. [See 6.35.]

26.4.15.

Page 43

It must be through generality that ordinary propositions get their stamp of simplicity.

Page 43

We must recognize *how* language takes care of itself.

Page 43

The proposition that is about a complex stands in internal relation to the proposition about its component part. [See 3.24.]

27.4.15.

Page 43

The freedom of the will consists in the fact that future events *cannot* be KNOWN now. It would only be possible for us to know them, if causality were an INNER necessity--like, say, that of logical inference.--The connexion between knowledge and thing known is *the* connexion of logical necessity. [See 5.1362.]

Page 43

I cannot need to worry about language.

Page 43

Non-truth is like non-identity.

28.4.15.

Page 43

The operation of negating does not consist in, say, putting down a \sim , but in the class of all negating operations.

Page 43

But in that case what really are the properties of this ideal negating operation?

Page 43

How does it come out that two assertions are compatible?

Page 43

If one puts p instead of q in $p \vee q$ the statement turns into p .

Page Break 44

Page 44

Does the sign $p.q$ also belong among those which assert p ?--Is p one of the signs for $p \vee q$?

Page 44

Can one say the following?: All signs that do *not* assert p , are *not* asserted by p and do *not* contain p as tautology or contradiction does--all these signs negate p .

29.4.15.

Page 44

That is to say: All signs that are dependent on p and that neither assert p nor are asserted by p .

30.4.15.

Page 44

The occurrence of an *operation* cannot, *of course*, have any import by itself.

Page 44

p is asserted by all propositions from which it follows. [5.124.]

Page 44

Every proposition that contradicts p negates p . [See 5.1241.]

1.5.15.

Page 44

The fact that $p.\sim p$ is a contradiction shews that $\sim p$ contradicts p . [Cf. 6.1201.]

Page 44

Scepticism is *not* irrefutable, but *obvious nonsense* if it tries to doubt where no question can be asked. [See 6.51.]

Page 44

For doubt can only exist where a question exists; a question can only exist where an answer exists, and this can only exist where something *can* be said. [See 6.51.]

Page 44

All theories that say: "This is how it must be, otherwise we could not philosophize" or "otherwise we surely could not live", etc. etc., must of course disappear.

Page 44

My method is not to sunder the hard from the soft, but to see the hardness of the soft.

Page 44

It is one of the chief skills of the philosopher not to occupy himself with questions which do not concern him.

Page 44

Russell's method in his "Scientific method in philosophy" is simply a retrogression from the method of physics.

2.5.15.

Page 44

The class of all signs that assert both p and q is the sign for $p.q$. The class of all signs which assert either p or q is the proposition " $p \vee q$ ". [Cf. 5.513.]

Page Break 45

3.5.15.

Page 45

We cannot say that both tautology and contradiction say *nothing* in the sense that they are both, say, zero points in a scale of propositions. For at least they are *opposite* poles.

Page 45

Can we say: two propositions are opposed to one another when there is no sign that asserts them both--which really means: when they have no common member? [Cf. 5.1241.]

Page 45

Thus propositions are imagined as classes of signs--the propositions " p " and " q " have the member " $p.q$ " in common--and two propositions are opposed to one another when they lie quite outside one another. [Cf. 5.513.]

Page 45

The so-called law of induction cannot at any rate be a logical law, for it is evidently a proposition. [See 6.31.]

Page 45

The class of all propositions of the form Fx is the proposition $(x) \phi x$.

Page 45

Does the general form of proposition exist?

Page 45

Yes, if by that is understood the single "logical constant". [Cf. 5.47.]

Page 45

It keeps on looking as if the question "Are there simple things?" made sense. And surely this question must be nonsense!----

Page 45

It would be vain to try and express the pseudo-sentence "Are there simple things?" in symbolic notation.

Page 45

And yet it is clear that I have before me a concept of a thing, of simple correlation, when I think about this matter.

Page 45

But how am I imagining the simple? Here all I can say is always "'x' has reference".--Here is a great riddle!

Page 45

As examples of the simple I always think of points of the visual field (just as parts of the visual field always come before my mind as typical composite objects).

Page 45

Is spatial complexity also logical complexity? It surely seems to be.

Page 45

But what is a uniformly coloured part of my visual field composed of? Of *minima sensibilia*? How should the place of one such be determined?

Page Break 46

Page 46

Even if the sentences which we ordinarily use all contain generalizations, still there must surely occur in them the proto-pictures of the component parts of their special cases. Thus the question remains how we arrive at those.

Page 46

The fact that there is no sign for a particular proto-picture does not show that that proto-picture is not present. Portrayal by means of sign language does not take place in such a way that a *sign* of a proto-picture goes proxy for an *object* of that proto-picture. The sign and the internal relation to what is signified determine the proto-picture of the latter; as the fundamental co-ordinates together with the ordinates determine the points of a figure.

Page 46

A question: can we manage without simple objects in LOGIC?

Page 46

Obviously propositions are possible which contain no simple signs, i.e. no signs which have an immediate reference. And these are really *propositions* making sense, nor do the definitions of their component parts have to be attached to them.

Page 46

But it is clear that components of our propositions can be analysed by means of a definition, and must be, if we want to approximate to the real structure of the proposition. *At any rate, then, there is a process of analysis.* And can it not now be asked whether this process comes to an end? And if so: What will the end be?

Page 46

If it is true that every defined sign signifies *via* its definitions then presumably the chain of definitions must some time have an end. [Cf. 3.261.]

Page 46

The analysed proposition mentions more than the unanalysed.

Page 46

Analysis makes the proposition more complicated than it was, but it cannot and must not make it more complicated than its meaning was from the first.

Page 46

When the proposition is just as complex as its reference, then it is *completely* analysed.

Page 46

But the reference of our propositions is not infinitely complicated.

Page 46

The proposition is the picture of the fact. I can devise different pictures of a fact. (The logical operations serve this purpose.) But

Page Break 47

what is characteristic of the *fact* will be the same in all of these pictures and will not depend on me.

Page 47

With the class of signs of the proposition "p" the class " $\sim p$ ", etc. etc. is already given. As indeed is necessary.

Page 47

But does not that of itself presuppose that the class of all propositions is given us? And how do we arrive at *it*?

11.5.15.

Page 47

Is the logical sum of two tautologies a tautology in the first sense? Is there really such a thing as the duality: tautology--contradiction?

Page 47

The simple thing for us is: the simplest thing that we are acquainted with.---The simplest thing which our analysis can attain--it need appear only as a prototype, as a variable in our propositions---*that* is the simple thing that we mean and look for.

12.5.15.

Page 47

The general concepts (a) of portrayal and (b) of co-ordinates.

Page 47

Supposing that the expression " $\sim(\exists x)x = x$ " were a proposition, namely (say), this one: "There are no things", then it would be matter for great wonder that, in order to express this proposition in symbols, we had to make use of a relation (=) with which it was really not concerned at all.

13.5.15.

Page 47

A singular logical manipulation, the *personification of time*!

Page 47

Just don't pull the knot tight before being certain that you have got hold of the right end.

Page 47

Can we regard a part of space as a thing? In a certain sense we obviously always do this when we talk of spatial things.

Page 47

For it seems--at least so far as I can see at present--that the matter is not settled by getting rid of names by means of definitions: complex spatial objects, for example, seem to me in some sense to be essentially things--I as it were see them as things.--And the designation of them by means of names seems to be more than a mere trick of language. Spatial complex objects--for example--really, so it seems, do appear as things.

Page 47

But what does all that signify?

Page Break 48

Page 48

At any rate that we quite instinctively designate those objects by means of names.--

14.5.15.

Page 48

Language is a part of our organism, and no less complicated than it. [*Cf.* 4.002.]

Page 48

The old problem of complex and fact!

15.5.15.

Page 48

The theory of the complex is expressed in such propositions as: "If a proposition is true then Something exists"; there seems to be a difference between the fact expressed by the proposition: a stands in the relation R to b, and the complex: *a in the relation R to b*, which is just that which "exists" if that proposition is true. It seems as if we could *designate* this Something, and what's more with a real "complex sign".--The feelings expressed in these sentences are quite natural and unartificial, so there must be some truth at the bottom of them. But what truth?

Page 48

What depends on my life?

Page 48

So much is clear, that a complex can only be given by means of its description; and this description will hold or not hold. [See 3.24.]

Page 48

The proposition dealing with a complex will not be nonsensical if the complex does not exist, but simply false. [See 3.24.]

16.5.15.

Page 48

When I see space do I see all its points?

Page 48

It is no more possible to present something "contradicting logic" in language than to present a figure contradicting the laws of space in geometry by means of its coordinates, or, say, to give the coordinates of a point that does not exist. [3.032.]

Page 48

If there were propositions asserting the existence of proto-pictures they would be unique and would be a kind of "logical propositions" and the set of these propositions would give logic an impossible reality. There would be co-ordination in logic.

18.5.15.

Page 48

The possibility of all similes, of the whole pictorial character of our language, is founded in the logic of portrayal. [4.015.]

Page Break 49

19.5.15.

Page 49

We can even conceive a body apprehended as in movement, *and together with its movement*, as a thing. So the moon circling round the earth moves round the sun. Now here it seems clear that this reification is nothing but a logical manipulation--though the possibility of this may be extremely significant.

Page 49

Or let us consider reifications like: a tune, a spoken sentence.--

Page 49

When I say "'x' has reference" do I have the feeling: "it is impossible that 'x' should stand for, say, this knife or this letter"? Not at all. On the contrary.

20.5.15.

Page 49

A complex just is a thing!

21.5.15.

Page 49

We can quite well give a spatial representation of a set of circumstances which contradict the laws of physics, but not of one contradicting the laws of geometry. [3.0321.]

22.5.15.

Page 49

The mathematical notation for infinite series like

$$"1 + x/1! + x^2/2! + \dots"$$

together with the dots is an example of that extended generality. A law is given and the terms that are written down serve as an illustration.

Page 49

In this way instead of (x)fx one might write "fx.fy....".

Page 49

Spatial and *temporal* complexes.

23.5.15.

Page 49

The limits of my language mean the limits of my world. [5.6]

Page 49

There really is only one world soul, which I for preference call *my* soul and as which alone I conceive what I call the souls of others.

Page 49

The above remark gives the key for deciding the way in which solipsism is a truth. [See 5.62.]

Page 49

I have long been conscious that it would be possible for me to write a book: "The world I found". [Cf. 5.631.]

Page 49

The feeling of the simple relation which always comes before our mind as the main ground for the assumption of "simple objects"--

Page Break 50

haven't we got this very same feeling when we think of the relation between name and complex object?

Page 50

Suppose the complex object is this book. Let it be called "A". Then surely the occurrence of "A" in the proposition shews the occurrence of the book in the fact. *For it is not arbitrarily resolved even when it is analysed, so as, e.g., to make its resolution a completely different one in each propositional formation.*----[See 3.3442.]

Page 50

And like the occurrence of the name of a thing in different propositions, the occurrence of the name of compounded objects shews that there is a form and a content in common.

Page 50

In spite of this the *infinitely* complex situation seems to be a chimera.

Page 50

But it also seems certain that we do not infer the existence of simple objects from the existence of particular simple objects, but rather know them--by description, as it were--as the end-product of analysis, by means of a process that leads to them.

Page 50

For the very reason, that a bit of language is nonsensical, it is still possible to go on using it--see the last remark.

Page 50

In the book "The world I found" I should also have to report on my body and say which members are subject to my will, etc. For this is a way of isolating the subject, or rather of skewing that in an important sense there is no such thing as the subject; for it would be the one thing that could *not* come into this book. [See 5.631.]

24.5.15.

Page 50

Even though we have no acquaintance with simple objects we *do* know complex objects by acquaintance, we know by acquaintance that they are complex.--And that in the end they must consist of simple things?

Page 50

We single out a part of our visual field, for example, and we see that it is always complex, that any part of it is still complex but is already simpler, and so on----.

Page 50

Is it imaginable that--e.g.--we should *see* that *all the pointy of a surface are yellow*, without seeing any *single* point of this surface? It almost seems to be so.

Page 50

The way problems arise: the pressure of a tension which then concentrates into a question, and becomes objective.

Page Break 51

Page 51

How should we describe, e.g., a surface uniformly covered with blue?

Page 51

Does the visual image of a *minimum visibile* actually appear to us as indivisible? What has extension is divisible. Are there parts in our visual image that have no extension? E.g., the images of the fixed stars?--

Page 51

The urge towards the mystical comes of the non-satisfaction of our wishes by science. We *feel* that even if all *possible* scientific questions are answered *our problem is still not touched at all*. Of course in that case there are no questions any more; and that is the answer. [Cf. 6.52.]

Page 51

The tautology is asserted, the contradiction denied, by *every* proposition. (For one could append 'and' and some tautology to any proposition without altering its sense; and equally the negation of a contradiction.)

Page 51

And "without altering its sense" means: without altering the *essential* thing about the sign itself. For: the *sign* cannot be altered without altering its sense. [Cf. 4.465.]

Page 51

"aRa" *must* make sense if "aRb" makes sense.

26.5.15.

Page 51

But how am I to explain the general nature of the *proposition* now? We can indeed say: everything that is (or is not) the case can be pictured by means of a proposition. But here we have the expression "*to be the case*"! It is just as problematic.

Page 51

Objects form the counterpart to the proposition.

Page 51

Objects I can only *name*. Signs go proxy for them. [See 3.221.]

27.5.15.

Page 51

I can only speak *of* them, I cannot express them. [See 3.221.]

Page 51

"But might there not be something which cannot be expressed by a *proposition* (and which is also not an object)?" In that case this could not be expressed by means of *language*; and it is also impossible for us to *ask* about it.

Page 51

Suppose there is something outside the *facts*? Which our propositions are impotent to express? But here we do have, e.g., *things and we feel no demand at all* to express them in propositions.

Page Break 52

Page 52

What cannot be expressed we do not express----. And how try to *ask* whether THAT can be expressed which cannot be EXPRESSED?

Page 52

Is there no domain outside the facts?

28.5.15.

Page 52

"Complex sign" and "proposition" are *equivalent*.

Page 52

Is it a tautology to say: *Language* consists of *sentences*?

Page 52

It seems it *is*.

29.5.15.

Page 52

But is *language*: the *only* language?

Page 52

Why should there not be a mode of expression through which I can talk *about* language in such a way that it can appear to me in co-ordination with something else?

Page 52

Suppose that music were such a mode of expression: then it is at any rate characteristic of *science* that *no*

musical themes can occur in it.

Page 52

I myself only write *sentences* down here. And why?

Page 52

How is language unique?

30.5.15.

Page 52

Words are like the film on deep water.

Page 52

It is clear that it comes to the same thing to ask what a sentence is, and to ask what a fact is--or a complex.

Page 52

And why should we not say: "There are complexes; one can use names to name them, or propositions to portray them"?

Page 52

The name of a complex functions in the proposition like the name of an object that I only know by *description*.----The proposition that depicts it functions as a description.

Page 52

But if there are simple objects, is it correct to call both the signs for them and those other signs "names"?

Page 52

Or is "name" so to speak a *logical* concept?

Page 52

"It signalises what is common to a form and a content."----

Page 52

According to the difference in the structure of the complex its name denotes in a different way and is subject to different syntactical laws.

Page Break 53

Page 53

The mistake in this conception must lie in its, on the one hand, contrasting complexes and simple objects, while on the other hand it treats them as akin.

Page 53

And yet: *Components* and *complex* seem to be akin, *and* to be opposed to one another.

Page 53

(Like the plan of a town and the map of a country which we have before us, the same size and on different scales.)

Page 53

What is the source of the feeling "I can correlate a name with all that I see, with this landscape, with the dance of motes in the air, with all this; indeed, what should we call a name if not this"?!

Page 53

Names signalise what is common to a single form and a single content.--Only *together with* their syntactical use do they signalise *one particular* logical form. [*Cf.* 3.327.]

31.5.15.

Page 53

One cannot achieve any more by using names in describing the world than by means of the general description of the world!!!

Page 53

Could one then manage without names? Surely not.

Page 53

Names are necessary for an assertion that *this* thing possesses *that* property and so on.

Page 53

They link the propositional form with quite definite objects.

Page 53

And if the general description of the world is like a stencil of the world, the names pin it to the world so that the world is wholly covered by it.

1.6.15.

Page 53

The great problem round which everything that I write turns is: Is there an order in the world *a priori*, and if

so what does it consist in?

Page 53

You are looking into fog and for that reason persuade yourself that the goal is already close. But the fog disperses and the goal is not yet in sight.

2.6.15.

Page 53

I said: "A tautology is asserted by every proposition"; but that is not enough to tell us why it is not a *proposition*. For has it told us *why* a proposition cannot be asserted by p and $\sim p$?

Page 53

For my theory does not really bring it out that the proposition *must* have two poles.

Page Break 54

Page 54

For what I should now have to do is to find an expression in the language of this theory for HOW MUCH *a proposition says*. And this would have to yield the result that tautologies say NOTHING.

Page 54

But how can we find the measure of amount-that-is-said?

Page 54

At any rate it is there; and our theory *must* be able to give it expression.

3.6.15.

Page 54

One could certainly say: *That* proposition says the most from which the most follows.

Page 54

Could one say: "From which the most mutually independent propositions follow"?

Page 54

But doesn't it work like this: If p follows from q but not q from p , then q says more than p ?

Page 54

But now nothing at all follows from a tautology.----It however follows from every proposition. [*Cf.* 5.142.]

Page 54

The analogous thing holds of its opposite.

Page 54

But then! Won't contradiction now be the proposition that says the most? From " $p \sim p$ " there follows not merely " p " but also " $\sim p$ "! Every proposition follows from them and they follow from none!? But I surely can't infer anything from a contradiction, just *because* it is a contradiction.

Page 54

But if contradiction is the class of *all propositions*, then tautology becomes what is common to any classes of propositions that have nothing in common and vanishes completely. [*Cf.* 5.143.]

Page 54

" $p \vee \sim p$ " would then be a sign only in appearance. But in reality the dissolution of the proposition.

Page 54

The tautology as it were vanishes inside all propositions, the contradiction outside all propositions. [*See* 5.143.]

Page 54

In these investigations I always seem to be unconsciously taking the elementary proposition as my starting point.--

Page 54

Contradiction is the outer limit of propositions; no proposition asserts it. Tautology is their substanceless centre. (The middle point of a circle can be conceived as its inner boundary.) [*Cf.* 5.143.]

Page 54

(The key word still hasn't yet been spoken.)

Page Break 55

Page 55

The thing is that here it is very easy to confuse the logical product and the logical sum.

Page 55

For we come to the apparently remarkable result that two propositions must have something in common in order to be capable of being asserted by one proposition.

Page 55
(Belonging to a single class, however, is also something that propositions can have in *common*.)

Page 55
(Here there is still a definite and decisive lack of clarity in my theory. Hence a certain feeling of dissatisfaction')

4.6.15.

Page 55
"p.q" only makes sense if "p \vee q" makes sense.

5.6.15.

Page 55
"p.q" asserts "p" and "q" but that surely does not mean that "p.q" is the common component of "p" and "q", but on the contrary that "p" and also "q" are equally contained in "p.q".

Page 55
In this sense p and \sim p would have something in common, for example propositions like \sim p \vee q and p \vee q. That is: there are indeed propositions which are asserted by "p" as well as by " \sim p"--e.g. the above ones--but there are none that assert p as well as also asserting \sim p.

Page 55
In order for a proposition to be capable of being true it must also be capable of being false.

Page 55
Why does tautology say nothing? Because every possibility is admitted in it in advance; because.....

Page 55
It must shew *in the proposition itself* that it says *something* and in the tautology that it says nothing.

Page 55
p. \sim p is that thing--perhaps *that nothing*--that p and \sim p have in common.

Page 55
In the *real* sign for p there is already contained the sign "p \vee q". (For it is then possible to form this sign WITHOUT FURTHER ADO.)

6.6.15.

Page 55
(This theory treats of propositions exclusively, so to speak, as a world on their own and not in connexion with what they present.)

Page 55
The connexion of the picture-theory with the class-theory \dagger 1 will only become quite obvious later.

Page 55
One cannot say of a tautology that it is true, for it is *made so as to be true*.

Page Break 56

Page 56
It is not a picture of reality, in the sense that it does not PRESENT anything; it is what all--mutually contradictory--*pictures* have in common.

Page 56
In the class-theory it is not yet evident why the proposition needs its counter-proposition. Why it is a part of logical space which is *separated* from the remaining part of logical space.

Page 56
The proposition says: *this* is how it is and not: *that*. It presents a possibility and itself *conspicuously* forms one part of a whole,--whose features it bears--and from which it stands out.

Page 56
p \vee q \vee \sim p is also a tautology.----

Page 56
There are certainly propositions that *allow* p as well as \sim p but *none* that *assert* p as well as \sim p.

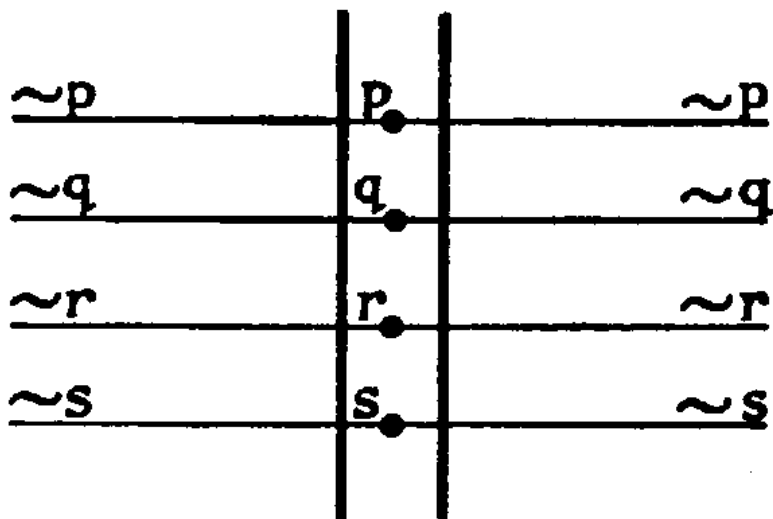

Page 56

The possibility of " $p \vee q$ " when " p " is given, is a possibility in a different dimension from the impossibility of " $\sim p$ ".

Page 56

" $p \vee \sim p$ " is a QUITE SPECIAL CASE of " $p \vee q$ ".

Page 56

" p " has nothing in common with " $\sim p \vee q$ ".

Page 56

By my attaching the " \sim " to " p " the proposition gets into a different class of propositions.

Page 56

Every proposition has only one negative;... There is only one proposition lying quite outside " p ". [Cf. 5.513.]

Page 56

It could also be said: The proposition which asserts p and $\sim p$ is negated by all propositions; the proposition which asserts p or $\sim p$ is asserted by all propositions.

Page 56

My mistake must lie in my wanting to use what follows from the nature of negation, etc. In its definition.--That " p " and " $\sim p$ " have

Page Break 57

a common boundary is no part of the explanation of negation that I am trying for.

7.6.15.

Page 57

If, e.g., it could be said: All propositions that do not assert p assert $\sim p$, then that would give us an adequate description.--But that doesn't work.

Page 57

But can't we say that " $\sim p$ " is what is common only to such propositions as do not assert " p "? And from this there already follows the impossibility of " $p.\sim p$ ".

Page 57

(All this, of course, already presupposes the existence of the whole *world of propositions*. Rightly?)

Page 57

IT IS NOT ENOUGH to point to $\sim p$'s lying outside p . It will only be possible to derive all the properties of " $\sim p$ " if " $\sim p$ " is introduced *essentially as the negative of p*.

Page 57

But how to do that?--

Page 57

Or is it like this: We cannot "introduce" the proposition $\sim p$ at all, but we encounter it as a *fait accompli* and we can only point to its individual formal properties, as, e.g., that it has nothing in common with p , that no proposition contains it and p , etc. etc.?

8.6.15.

Page 57

Every mathematical proposition is a symbolic representation of a *modus ponens*. (And it is clear that the *modus ponens* cannot be expressed in a proposition.) [Cf. 6.1264.]

Page 57

p and $\sim p$ have a common boundary: this is expressed by the fact that the negative of a proposition is only determined by means of the proposition itself. For we say: The negative of a proposition is a proposition which... and now follows the relation of $\sim p$ to p.----

9.6.15.

Page 57

It will, of course, be possible simply to say: The negation of p is the proposition which has no proposition in common with p.

Page 57

The expression "tertium non datur" is really a piece of nonsense. (For no third thing is in question in $p \vee \sim p$.)

Page 57

Should we not be able to use this for our definition of the negative of a proposition?

Page 57

Can't we say: Among all the propositions that are dependent on p alone, there are only such as assert p and such as deny it?

Page Break 58

Page 58

So I can say that the negative of p is the class of all propositions which are dependent on "p" alone and *do not assert "p"*.

10.6.15.

Page 58

" $p \cdot q \vee \sim q$ " is NOT dependent on "q"!

Page 58

Whole propositions, to disappear!

Page 58

The very fact that " $p \cdot q \vee \sim q$ " is independent of "q", although it obviously contains the written sign "q", shews us how signs of the form $\eta \vee \sim \eta$ can apparently, but still only *apparently*, exist.

Page 58

This naturally arises from the fact that this arrangement " $p \vee \sim p$ " is indeed externally possible, but does not satisfy the conditions for such a complex to *say something* and so be a proposition.

Page 58

" $p \cdot q \vee \sim q$ " says the same as
" $p \cdot r \vee \sim r$ "

--whatever q and r may say--: All tautologies say the same thing. (Namely nothing.) [Cf. 5.43.]

Page 58

From the last explanation of negation it follows that all propositions which are dependent on p alone and which do not assert p--and only these--negate p. So " $p \vee \sim p$ " and " $p \cdot \sim p$ " are not propositions, for the first sign neither asserts nor denies p and the second would have to affirm both.

Page 58

But since I can after all write down $p \vee \sim p$ and $p \cdot \sim p$, particularly in connexion with other sentences, it must be clearly set forth what role these pseudo-propositions have, especially in such connexions. For they are not, of course, to be treated as a completely meaningless appendix--like e.g. a meaningless name. Rather do they belong in the symbolism--like "0" in arithmetic. [Cf. 4.4611.]

Page 58

Here it is clear that $p \vee \sim p$ has the role of a true proposition, which however says *nought*.

Page 58

So we have again arrived at the quantity of what is said.

11.6.15.

Page 58

The opposite of " $p \cdot \sim p$ " follows from all propositions; is that as much as to say that " $p \cdot \sim p$ " says nothing?--By my earlier rule the contradiction would have to say more than all other propositions.

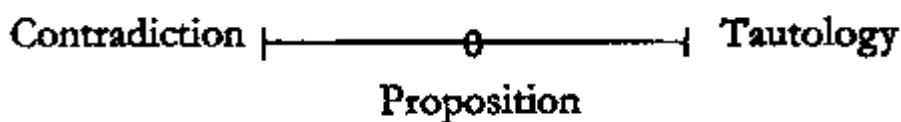

If a proposition saying a great deal is false, it ought to be interesting

that it is false. It is astonishing that the negative of a proposition that says a great deal should say absolutely nothing.

We said: If p follows from q but not q from p, q says more than p. But now, if it follows from p that q is false, but not from q that p is false, what then?

From p there follows $\sim q$, from q not $\sim p$.----?

12.6.15.

In connexion with any proposition it could really be asked: what does it come to for it to be true? What does it come to for it to be false?

Now the 'assumption' in $p.\sim p$ is never anything but false, and so this does not come to anything; and as for what it would amount to if it were true, of course, that can't be asked at all.

13.6.15.

If " $p.\sim p$ " COULD be true it would indeed say a *very* great deal. But the *assumption* that it is true does not come into consideration in connexion with it, as the 'assumption' in it is always false.

Singular, since the words "true" and "false" refer to the relation of the proposition to the world, that these words can be used in the proposition itself for purposes of representation!

We have said: if a proposition depends only on p and it asserts p then it does not negate it, and vice versa: *Is this the picture of that mutual exclusion of p and $\sim p$? Of the fact that $\sim p$ is what lies outside p?*

It seems so! The proposition " $\sim p$ " is in the same sense what lies outside "p".----(Do not forget either that the picture may have very complicated co-ordinates to the world.)

One might simply say: " $p.\sim p$ " says nothing in the proper sense of the word. For in advance there is no possibility left which it can *correctly* present.

Incidentally, if "p follows from q" means: If q is true then p must be true, then it cannot be said at all that anything follows from " $p.\sim p$ ", since there is no such thing as the hypothesis that " $p.\sim p$ " is true.

14.6.15.

We have become clear, then, that names may and do stand for the most various forms, and that it is only the syntactical application that signals the form that is to be presented.

Now what is the syntactical application of names of simple objects?

What is my fundamental thought when I talk about simple objects? Do not 'complex objects' in the end satisfy just the demands which I

apparently make on the simple ones? If I give this book a name "N" and now talk about N, is not the relation of N to that 'complex object', to those forms and contents, *essentially* the same as I imagined only between name and simple object?

For N.B.: even if the name "N" vanishes on further analysis, still it indicates a *single common* thing.

But what about the reference of names out of the context of the proposition?

The question might however also be presented like this: It seems that the idea of the SIMPLE is already to be found contained in that of the complex and in the idea of analysis, and in such a way that we come to this idea quite

apart from any examples of simple objects, or of propositions which mention them, and we realize the existence of the simple object--*a priori*--as a logical necessity.

Page 60

So it looks as if the existence of the simple objects were related to that of the complex ones as the sense of $\sim p$ is to the sense of p : the *simple* object is *prejudged* in the complex.

15.6.15.

Page 60

(This is NOT to be confused with the *fact* that its *component* is prejudged in the complex.)

Page 60

(One of the most difficult of the philosopher's tasks is to find out where the shoe pinches.)

Page 60

It is quite clear that I can in fact correlate a name with this watch just as it lies here ticking in front of me, and that this name will have reference outside any proposition in the very sense I have always given that word, and I feel that that name in a proposition will correspond to all the requirements of the 'names of simple objects'.

16.6.15.

Page 60

Now we just want to see whether this watch in fact corresponds to all the conditions for being a 'simple object'.----

Page 60

The question is really this: In order to know the syntactical treatment of a name, must I know the composition of its reference? If so, then the whole composition is already expressed even in the unanalysed proposition....

Page 60

(One often tries to jump over too wide chasms of thought and then falls in.)

Page Break 61

Page 61

What seems to be given us *a priori* is the concept: *This.*--Identical with the concept of the *object*.

Page 61

Relations and properties, etc. are *objects* too.

Page 61

My difficulty surely consists in this: In all the propositions that occur to me there occur names, which, however, must disappear on further analysis. I know that such a further analysis is possible, but am unable to carry it out completely. In spite of this I certainly seem to know that if the analysis were completely carried out, its result would have to be a proposition which once more contained names, relations, etc. In brief it looks as if in this way I knew a form without being acquainted with any single example of it.

Page 61

I see that the analysis can be carried farther, and can, so to speak, not imagine its leading to anything different from the species of propositions that I am familiar with.

Page 61

When I say this watch is shiny, and what I mean by this watch alters its composition in the smallest particular, then this means not merely that the sense of the sentence alters in its content, but also *what I am saying about this watch* straightway alters its sense. The whole form of the proposition alters.

Page 61

That is to say, the syntactical employment of the names completely characterizes the form of the complex objects which they denote.

Page 61

Every proposition that has a sense has a COMPLETE sense, and it is a picture of reality in such a way that what is not yet said in it simply cannot belong to its sense.

Page 61

If the proposition "this watch is shiny" has a sense, it must be explicable HOW THIS proposition has THIS sense.

Page 61

If a proposition tells us something, then it must be a picture of reality just as it is, and a complete picture at that.----There will, of course, also be something that it does *not* say--but what it does say it says completely and it must be susceptible of SHARP definition.

Page 61

So a proposition may indeed be an incomplete picture of a certain fact, but it is ALWAYS *a complete picture*. [Cf. 5.156.]

Page 61

From this it would now seem as if in a certain sense all names were *genuine names*. Or, as I might also say, as if all objects were in a certain sense simple objects.

Page Break 62

17.6.15.

Page 62

Let us assume that every spatial object consists of infinitely many points, then it is clear that I cannot mention all these by name when I speak of that object. Here then would be a case in which I *cannot* arrive at the complete analysis in the old sense at all; and perhaps just this is the usual case.

Page 62

But this is surely clear: the propositions which are the only ones that humanity uses will have a sense just as they are and do not wait upon a future analysis in order to acquire a sense.

Page 62

Now, however, it seems to be a legitimate question: Are--e.g.--spatial objects composed of simple parts; in analysing them, does one arrive at parts that cannot be further analysed, or is this not the case?

Page 62

--But what kind of question is this?--

Page 62

Is it, A PRIORI, clear that in analysing we must arrive at simple components--is this, e.g., involved in the concept of analysis--, or is analysis *ad infinitum* possible?--Or is there in the end even a third possibility?

Page 62

This question is a logical one and the complexity of spatial objects is a logical complexity, for to say that one thing is part of another is always a tautology.

Page 62

But suppose, for example, that I wanted to say that ONE component of a fact had a particular property? Then I should have to mention it by name and use a logical sum.

Page 62

And nothing seems to speak against infinite divisibility.

Page 62

And it keeps on forcing itself upon us that there is some simple indivisible, an element of being, in brief a thing.

Page 62

It does not go against our feeling, that *we* cannot analyse PROPOSITIONS so far as to mention the elements by name; no, we feel that the WORLD must consist of elements. And it appears as if that were identical with the proposition that the world must be what it is, it must be definite. Or in other words, what vacillates is our determinations, not the world. It looks as if to deny things were as much as to say that the world can, as it were, be indefinite in some such sense as that in which our knowledge is uncertain and indefinite.

Page 62

The world has a fixed structure.

Page Break 63

Page 63

Is the representation by means of unanalysable names *only one system*?

Page 63

All I want is only for *my meaning* to be completely analysed!

Page 63

In other words the proposition must be completely articulated. Everything that its sense has in common with another sense must be contained separately in the proposition. If generalizations occur, then the forms of the particular cases must be manifest and it is clear that this demand is justified, otherwise the proposition cannot be a picture at all, of *anything*. [Cf. 3.251.]

Page 63

For if possibilities *are left open* in the proposition, *just this* must be *definite*: *what* is left open. The generalizations of the form--e.g.--must be definite. What I do not know I do not know, but the proposition must shew me WHAT I know. And in that case, is not this *definite* thing at which I *must* arrive precisely simple in that

sense that I have always had in mind? It is, so to speak, what is hard.

Page 63

In that case, then, what we mean by "complex objects do not exist" is: It must be clear in the proposition how the object is composed, so far as it is possible for us to speak of its complexity at all.--The sense of the proposition must appear in the proposition as divided into its *simple* components--. And these parts are then actually indivisible, for further divided they just would not be THESE. In other words, the proposition can then no longer be *replaced* by one that has more components, but any that has more components also does not have *this* sense.

Page 63

When the sense of the proposition is completely expressed in the proposition itself, the proposition is always divided into its simple components--no further division is possible and an apparent one is superfluous--and these are objects in the original sense.

18.6.15.

Page 63

If the complexity of an object is definitive of the sense of the proposition, then it must be portrayed in the proposition to the extent that it does determine the sense. And to the extent that its composition is *not* definitive of *this* sense, to this extent the objects of this proposition are *simple*. THEY *cannot* be further divided.----

Page 63

The demand for simple things *is* the demand for definiteness of sense. [Cf. 3.23.]

Page 63

---For if I am talking about, e.g., this watch, and mean something complex by that and nothing depends upon the way it is compounded,

Page Break 64

then a generalization will make its appearance in the proposition and the fundamental forms of the generalization will be completely determinate *so far as they are given at all*.

Page 64

If there is a final sense and a proposition expressing it completely, then there are also names for simple objects.

Page 64

That is the correct designation.

Page 64

But suppose that a simple name denotes an infinitely complex object? For example, perhaps we assert of a patch in our visual field that it is to the right of a line, and we assume that every patch in our visual field is infinitely complex. Then if we say that a point in that patch is to the right of the line, this proposition follows from the previous one, and if there are infinitely many points in the patch *then infinitely many propositions of different content follow LOGICALLY from that first one*. And this of itself shews that the proposition itself was as a matter of fact infinitely complex. That is, not the propositional sign by itself, but *it together with its syntactical application*.

Page 64

Now it seems, of course, *perfectly* possible that in reality infinitely many different propositions do *not* follow from such a proposition, because our visual field perhaps--or probably--does not consist of infinitely many parts--but continuous visual space is only a subsequent construction--; and in that case only a finite number of propositions follow from the one known and it itself is *finite* in every sense.

Page 64

But now, does not this *possible* infinite complexity of the sense impair its definiteness?

Page 64

We might demand definiteness in this way too!: if a proposition is to make sense then the syntactical employment of each of its parts must be settled in advance.--It is, e.g., not possible *only subsequently to come upon* the fact that a proposition follows from it. But, e.g., what propositions follow from a proposition must be completely settled before that proposition can have a sense!

Page 64

It seems to me perfectly possible that patches in our visual field are simple objects, in that we do not perceive any single point of a patch separately; the visual appearances of stars even seem certainly to be so. What I mean is: if, e.g., I say that this watch is not in the drawer, there is absolutely no need for it to FOLLOW LOGICALLY that a wheel which is in the watch is not in the drawer, for perhaps *I had not the least knowledge* that the wheel was in the watch, and hence

could not have meant by "this watch" the complex in which the wheel occurs. And it is certain--moreover--that I do not see all the parts of my *theoretical* visual field. Who knows *whether* I see infinitely many points?

Let us suppose that we were to see a circular patch: is the circular form its *property*? Certainly not. It seems to be a structural "property". And if I notice that a spot is round, am I not noticing an infinitely complicated structural property? Or I notice only that the spot has finite extension, and this of itself seems to *presuppose* an infinitely complex structure.

Not: One proposition follows from another, but the truth of the one follows from the truth of the other. (That is why it *follows* from "All men are mortal" that "If Socrates is a man, then he is mortal.")

A proposition can, however, quite well treat of infinitely many points without being infinitely complex in a particular sense.

19.6.15.

When we see that our visual field is complex we also see that it consists of *simpler* parts.

We can talk of functions of this and that kind without having any particular application in view.

For we don't have any examples before our minds when we use Fx and all the other variable form-signs.

In short: if we were to apply the prototypes only in connexion with names, there would be the possibility that we should know the existence of the prototypes from the existence of their special cases. But as it is we use *variables*, that is to say we talk, so to speak, of the prototypes by themselves, quite apart from any individual cases.

We portray the thing, the relation, the property, by means of variables and so shew that we do not derive these ideas from particular cases that occur to us, but possess them somehow *a priori*.

For the question arises: If the individual forms are, so to speak, given me in experience, then I surely can't make use of them in logic; in that case I cannot write down an x or a ϕy . But this I can surely not avoid at all.

An incidental question: Does logic deal with certain classes of functions and the like? And if not, what then is the import of Fx , ϕz , and so on in logic?

Then these must be signs of more general import!

There doesn't after all seem to be any setting up of a kind of logical inventory as I formerly imagined it.

The component parts of the proposition must be simple = The proposition must be completely articulated. [Cf. 3.251.]

But now does this SEEM to contradict the facts?----

For in logic we are apparently trying to produce ideal pictures of articulated propositions. But how is that possible?

Or can we deal with a proposition like "The watch is on the table" without further ado according to the rules of logic? No, here we say, for example, that no date is given in the proposition, that the proposition is only apparently... etc. etc.

So before we can deal with it we must, so it seems, transform it in a particular way.

But perhaps this is not conclusive, for could we not just as well apply our usual *logical* notation to the special proposition?

Page 66

Yes, this is the point: Can we justly apply logic just as it stands, say in *Principia Mathematica*, straightaway to *ordinary propositions*?

Page 66

Of course we cannot disregard what is *expressed* in our propositions by means of endings, prefixes, vowel changes, etc. etc.

Page 66

But we do apply mathematics, and with the greatest success, to ordinary propositions, namely to those of physics.

Page 66

But how remarkable: in the familiar theorems of mathematical physics there appear neither things nor functions nor relations nor any other logical forms of object! Instead of things what we have here is numbers, and the functions and relations are purely mathematical throughout)

Page 66

But it is surely a fact that these propositions are applied to solid reality.

Page Break 67

Page 67

The variables in those theorems do not--as is often said--stand for lengths, weights, time intervals, etc. at all, they simply stand for numbers and for nothing else.

Page 67

When, however, I want to apply numbers, I come to relations, things, etc. etc. I say, e.g.: This length is 5 yards and here I am talking of relations and things, and in the *completely ordinary* sense at that.

Page 67

Here we come to the question about the reference of variables in the propositions of physics. For these are not tautologies.

Page 67

A proposition of physics is obviously senseless if its application is not given. What sort of sense would it make to say: "k = m.p"?

Page 67

So the complete physical proposition does after all deal with things, relations and so on. (Which was really to be expected.)

Page 67

Now everything turns on the fact that I apply numbers to ordinary things, etc., which in fact says no more than that numbers occur in our quite ordinary sentences.

Page 67

The difficulty is really this: even when we want to express a *completely definite* sense there is the possibility of failure. So it seems that we have, so to speak, no guarantee that our proposition is really a picture of reality.

Page 67

The division of the body into *material points*, as we have it in physics, is nothing more than analysis into *simple components*.

Page 67

But could it be possible that the sentences in ordinary use have, as it were, only an incomplete sense (quite apart from their truth or falsehood), and that the propositions in physics, as it were, approach the stage where a proposition really has a complete sense?

Page 67

When I say, "The book is lying on the table", does this really have a completely clear sense? (An EXTREMELY important question.)

Page 67

But the sense must be clear, for after all we mean *something* by the proposition, and as much as we *certainly* mean must surely be clear.

Page 67

If the proposition "The book is on the table" has a clear sense, then I must, whatever *is the case*, be able to say whether the proposition is true or false. There could, however, very well occur *cases* in which I should not be able to say straight off whether the book is still to be called "lying on the table". Then--?

Then is the case here one of my knowing exactly what I want to say, but then making mistakes in expressing it?

Or can this uncertainty TOO be included in the proposition?

But it may also be that the proposition "The book is lying on the table" represents my sense completely, but that I am using the words, e.g., "lying on", with a *special* reference here, and that elsewhere they have another reference. What I mean by the verb is perhaps a quite special relation which the book now actually has to the table.

Then are the propositions of physics and the propositions of ordinary life at bottom equally sharp, and does the difference consist only in the more consistent application of signs in the language of science?

Is it or is it not possible to talk of a proposition's having a more or less sharp sense?

It seems clear that what we MEAN must always be "*sharp*".

Our expression of what we mean can in its turn only be right or wrong. And further the words can be applied consistently or inconsistently. There does not seem to be any other possibility.

When I say, e.g., that the table is a yard long, it is extremely questionable what I mean by this. But I presumably mean that the distance between THESE two points is a yard, and that the points belong to the table.

We said that mathematics has already been applied with success to ordinary propositions, but in propositions of physics it treats of completely different objects from those of our ordinary language. Must our propositions undergo *such* preparation, to make them capable of being dealt with mathematically? Evidently they must. When quantities come in question, then an expression like, e.g., "the length of this table" would not be adequate. This length would have to be defined, say, as the distance between two surfaces, etc. etc.

Mathematical sciences are distinguished from non-mathematical ones by treating of things of which ordinary language does not speak, whereas the latter talk about things that are generally familiar.

21.6.15.

Our difficulty was that we kept on speaking of simple objects and were unable to mention a single one.

If a point in space does not exist, then its co-ordinates do not exist either, and if the coordinates exist then the point exists too.--That's how it is in logic.

The simple sign is *essentially simple*.

It functions as a simple object. (What does that mean?)

Its composition becomes completely *indifferent*. It disappears from view.

It always looks as if there were complex objects functioning as simples, and then also really simple ones, like the material points of physics, etc..

It can be seen that a name stands for a complex object from an indefiniteness in the proposition in which it occurs. This comes of the generality of such propositions. We *know* that not everything is yet determined by this proposition. For the generality notation *contains* a proto-picture. [Cf. 3.24.]

All invisible masses, etc. etc. must come under the generality notation.

What is it for propositions to approximate to the truth?

But logic as it stands, e.g., in *Principia Mathematica* can quite well be applied to our ordinary propositions, e.g., from "All men are mortal" and "Socrates is a man" there follows according to this logic "Socrates is mortal" which is obviously correct although I equally obviously do not know what structure is possessed by the thing Socrates or the property of mortality. Here they just function as simple objects.

Obviously the circumstance that makes it possible for certain forms to be projected by means of a definition into a name, guarantees of itself that this name can then also be treated as a real one.

To anyone that sees clearly, it is obvious that a proposition like "This watch is lying on the table" contains a lot of indefiniteness, in spite of its form's being completely clear and simple in outward appearance. So we see that this simplicity is only constructed.

22.6.15.

It is then also clear to *the UNPREJUDICED mind* that the sense of the proposition "The watch is lying on the table" is more complicated than the proposition itself.

The conventions of our language are extraordinarily complicated. There is enormously much added in thought to each proposition and not said. (These conventions are exactly like Whitehead's 'Conventions'. They are definitions with *a certain generality of form.*) [Cf. 4.002.]

I only want to justify the vagueness of ordinary sentences, for it *can* be justified.

It is clear that *I know* what I *mean* by the vague proposition. But now someone else doesn't understand and says: "Yes, but if you mean that then you should have added such and such"; and now someone else again will not understand it and will demand that the proposition should be given in more detail still. I shall then reply: NOW THAT can *surely* be taken for granted.

I tell someone "The watch is lying on the table" and now he says: "Yes, but if the watch were in such-and-such a position would you still say it was lying on the table?" And I should become uncertain. This shews that I did not know what I meant by "lying" *in general*. If someone were to drive me into a corner in this way in order to shew that I did not know what I meant, I should say: "*I know* what I mean; I mean just THIS", pointing to the appropriate complex with my finger. And in this complex I do actually have the two objects in a relation.----But all that this *really* means is: The fact can SOMEHOW be portrayed by means of this form too.

Now when I do this and designate the objects by means of *names*, does that make them simple?

All the same, however, this proposition is a picture of that complex.

This object is *simple for me!*

If, e.g., I call some rod "A", and a ball "B", I can say that A is leaning against the wall, but not B. Here the internal nature of A and B comes into view.

A name designating an object thereby stands in a relation to it which is wholly determined by the logical kind of the object and which signalises that logical kind.

And it is clear that the object must be of a particular logical kind, it just is as complex, or as simple, as it is.

"The watch *is sitting* on the table" is senseless!

Only the complex part of the proposition can be true or false.

The name compresses its whole complex reference into one.

15.4.16.

Page 71

We can only foresee what we ourselves construct. [See 5.556.]

Page 71

But then where is the concept of a simple object still to be found?

Page 71

This concept does not so far come in here at all.

Page 71

We must be able to construct the simple functions because we must be able to give each sign a meaning.

Page 71

For the only sign which guarantees its meaning is function and argument.

16.4.16.

Page 71

Every simple proposition can be brought into the form ϕx .

Page 71

That is why we may compose all simple propositions from this form.

Page 71

Suppose that *all* simple propositions were given me: then it can simply be asked what propositions I can construct from them. And these are *all* propositions and this is *how* they are *bounded*. [4.51.]

Page 71

(p): $p = aRx.xRy... zRb$

Page 71

(p): $p = aRx$

17.4.16.

Page 71

The above definition can in its general form only be a rule for a written notation which has nothing to do with the sense of the signs.

Page 71

But can there be such a rule?

Page 71

The definition is only possible if it is itself not a proposition.

Page 71

In that case a proposition cannot treat of all propositions, while a definition can.

23.4.16.

Page 71

The above definition, however, just does not deal with all propositions, for it essentially contains real variables. It is quite analogous to an operation whose own result can be taken as its base.

26.4.16.

Page 71

In this way, and in this way alone, is it possible to proceed from one type to another. [Cf. 5.252.]

Page 71

And we can say that all types stand in hierarchies.

Page Break 72

Page 72

And the hierarchy is only possible by being built up by means of operations.

Page 72

Empirical reality is bounded by the number of objects.

Page 72

The boundary turns up again in the totality of simple propositions. [See 5.5561.]

Page 72

The hierarchies are and must be independent of reality. [See 5.5561.]

Page 72

The meanings of their terms are only determined by the correlation of objects and names.

27.4.16.

Page 72

Say I wanted to represent a function of three non-interchangeable arguments.

$\phi(x): \phi(), x$

Page 72

But should there be any mention of non-interchangeable arguments in logic? If so, this surely presupposes something about the character of reality.

6.5.16.

Page 72

At bottom the whole *Weltanschauung* of the moderns involves the illusion that the so-called laws of nature are explanations of natural phenomena. [6.371.]

Page 72

In this way they stop short at the laws of nature as at something *impregnable* as men of former times did at God and fate. [See 6.372.]

Page 72

And both are right and wrong. The older ones are indeed clearer in the sense that they acknowledge a clear terminus, while with the new system it is supposed to look as if *everything* had a foundation. [See 6.372.]

11.5.16.

Page 72

$|p \quad |(a, a)$

Page 72

There are also operations with two bases. And the "|" -operation is of this kind.

Page 72

$|(\xi, \eta)...$ is an arbitrary term of the series of results of as operation.
 $(\exists x). \phi x$

Page 72

Is $(\exists x)$ etc. really an operation?

Page 72

But what would be its base?

11.6.16.

Page 72

What do I know about God and the purpose of life?

Page 72

I know that this world exists.

Page Break 73

Page 73

That I am placed in it like my eye in its visual field.

Page 73

That something about it is problematic, which we call its meaning.

Page 73

That this meaning does not lie in it but outside it. [Cf. 6.41.]

Page 73

That life is the world. [Cf. 5.621.]

Page 73

That my will penetrates the world.

Page 73

That my will is good or evil.

Page 73

Therefore that good and evil are somehow connected with the meaning of the world.

Page 73

The meaning of life, i.e. the meaning of the world, we can call God.

And connect with this the comparison of God to a father.

Page 73

To pray is to think about the meaning of life.

Page 73

I cannot bend the happenings of the world to my will: I am completely powerless.

Page 73

I can only make myself independent of the world--and so in a certain sense master it--by renouncing any influence on happenings.

5.7.16.

Page 73

The world is independent of my will. [6.373.]

Page 73

Even if everything that we want were to happen, this would still only be, so to speak, a grace of fate, for what would guarantee it is not any logical connexion between will and world, and we could not in turn will the supposed physical connexion. [6.374.]

Page 73

If good or evil willing affects the world it can only affect the boundaries of the world, not the facts, what cannot be portrayed by language but can only be shewn in language. [Cf. 6.43.]

Page 73

In short, it must make the world a wholly different one. [See 6.43.]

Page 73

The world must, so to speak, wax or wane as a whole. As if by accession or loss of meaning. [Cf. 6.43.]

Page 73

As in death, too, the world does not change but stops existing. [6.431.]

6.7.16.

Page 73

And in this sense Dostoievsky is right when he says that the man who is happy is fulfilling the purpose of existence.

Page 73

Or again we could say that the man is fulfilling the purpose of existence who no longer needs to have any purpose except to live. That is to say, who is content.

Page Break 74

Page 74

The solution of the problem of life is to be seen in the disappearance of this problem. [See 6.521.]

Page 74

But is it possible for one so to live that life stops being problematic? That one is *living* in eternity and not in time?

7.7.16.

Page 74

Isn't this the reason why men to whom the meaning of life had become clear after long doubting could not say what this meaning consisted in? [See 6.521.]

Page 74

If I can imagine a "*kind* of object" without knowing whether there are such objects, then I must have constructed their proto-picture for myself.

Page 74

Isn't the method of mechanics based on this?

8.7.16.

Page 74

To believe in a God means to understand the question about the meaning of life.

Page 74

To believe in a God means to see that the facts of the world are not the end of the matter.

Page 74

To believe in God means to see that life has a meaning.

Page 74

The world is *given* me, i.e. my will enters into the world completely from outside as into something that is already there.

Page 74

(As for what my will is, I don't know yet.)

Page 74

That is why we have the feeling of being dependent on an alien will.

Page 74

However *this may be*, at any rate we *are* in a certain sense dependent, and what we are dependent on we can call God.

Page 74

In this sense God would simply be fate, or, what is the same thing: The world--which is independent of our will.

Page 74

I can make myself independent of fate.

Page 74

There are two godheads: the world and my independent I.

Page 74

I am either happy or unhappy, that is all. It can be said: good or evil do not exist.

Page 74

A man who is happy must have no fear. Not even in face of death.

Page 74

Only a man who lives not in time but in the present is happy.

Page Break 75

Page 75

For life in the present there is no death.

Page 75

Death is not an event in life. It is not a fact of the world. [Cf. 6.4311.]

Page 75

If by eternity is understood not infinite temporal duration but non-temporality, then it can be said that a man lives eternally if he lives in the present. [See 6.4311.]

Page 75

In order to live happily I must be in agreement with the world. And that is what "being happy" *means*.

Page 75

I am then, so to speak, in agreement with that alien will on which I appear dependent. That is to say: 'I am doing the will of God'.

Page 75

Fear in face of death is the best sign of a false, i.e. a bad, life.

Page 75

When my conscience upsets my equilibrium, then I am not in agreement with Something. But what is this? Is it *the world*?

Page 75

Certainly it is correct to say: Conscience is the voice of God.

Page 75

For example: it makes me unhappy to think that I have offended such and such a man. Is that my conscience?

Page 75

Can one say: "Act according to your conscience whatever it may be"?

Page 75

Live happy!

9.7.16.

Page 75

If the most general form of proposition could not be given, then there would have to come a moment where we suddenly had a new experience, so to speak a logical one.

Page 75

That is, of course, impossible.

Page 75

Do not forget that $(\exists x)fx$ does not mean: There is an x such that fx , but: There is a true proposition " fx ".

Page 75

The proposition fa speaks of particular objects, the general proposition of *all* objects.

11.7.16.

Page 75

The particular object is a very remarkable phenomenon.

Page 75

Instead of "all objects" we might say: All *particular objects*.

Page Break 76

Page 76

If all particular objects are given, "all objects" are given.

Page 76

In short with the particular objects all objects are given. [Cf. 5.524.]

Page 76

If there are objects, then that gives us "all objects" too. [Cf. 5.524.]

Page 76

That is why it must be possible to construct the unity of the elementary propositions and of the general propositions.

Page 76

For if the elementary propositions are given, that gives us *all* elementary propositions, too, and that gives us the general proposition.--And with that has not the unity been constructed? [Cf. 5.524.]

13.7.16.

Page 76

One keeps on feeling that even in the elementary proposition mention is made of all objects.

Page 76

$(\exists x)\phi x.x = a$

Page 76

If two operations are given which cannot be reduced to *one*, then it must at least be possible to set up a general form of their combination.

$\phi x, \psi y | \chi z, (\exists x), (x).$

Page 76

As obviously it can easily be explained how propositions can be formed by means of these operations and how propositions are not to be formed, this must also be capable *somehow* of exact expression.

14.7.16.

Page 76

And this expression must already be given in the general form of the sign of an operation.

Page 76

And mustn't this be the only legitimate expression of the application of an operation? Obviously it must!

Page 76

For if the form of operation can be expressed at all, then it must be expressed in such a way that it *can* only be applied correctly.

Page 76

Man cannot make himself happy without more ado.

Page 76

Whoever lives in the present lives without fear and hope.

21.7.16.

Page 76

What really is the situation of the human will? I will call "will" first and foremost the bearer of good and evil.

Page 76

Let us imagine a man who could use none of his limbs and hence could, in the ordinary sense, not exercise his *will*. He could, however, think and *want* and communicate his thoughts to someone else. Could

Page Break 77

therefore do good or evil through the other man. Then it is clear that ethics would have validity for him, too, and that he in the *ethical sense* is the bearer of a *will*.

Page 77

Now is there any difference in principle between this will and that which sets the human body in motion?

Page 77

Or is the mistake here this: even *wanting* (thinking) is an activity of the will? (And in this sense, indeed, a man *without* will would not be alive.)

Page 77

But can we conceive a being that isn't capable of Will at all, but only of Idea (of seeing for example)? In some sense this seems impossible. But if it were possible then there could also be a world without ethics.

24.7.16.

Page 77

The World and Life are one. [5.621.]

Page 77

Physiological life is of course not "Life". And neither is psychological life. Life is the world.

Page 77

Ethics does not treat of the world. Ethics must be a condition of the world, like logic.

Page 77

Ethics and aesthetics are one. [See 6.421.]

29.7.16.

Page 77

For it is a fact of logic that wanting does not stand in any logical connexion with its own fulfilment. And it is also clear that the world of the happy is a *different* world from the world of the unhappy. [Cf. 6.43.]

Page 77

Is seeing an activity?

Page 77

Is it possible to will good, to will evil, and not to will?

Page 77

Or is only he happy who does *not* will?

Page 77

"To love one's neighbour" would mean to will!

Page 77

But can one want and yet not be unhappy if the want does not attain fulfilment? (And this possibility always exists.)

Page 77

Is it, according to common conceptions, good to want *nothing* for one's neighbour, neither good nor evil?

Page 77

And yet in a certain sense it seems that not wanting is the only good.

Page Break 78

Page 78

Here I am still making crude mistakes! No doubt of that!

Page 78

It is generally assumed that it is evil to want someone else to be unfortunate. Can this be correct? Can it be worse than to want him to be fortunate?

Page 78

Here everything seems to turn, so to speak, on *how* one wants.

Page 78

It seems one can't say anything more than: Live happily!

Page 78

The world of the happy is a different world from that of the unhappy. [See 6.43.]

Page 78

The world of the happy is a *happy world*.

Page 78

Then can there be a world that is neither happy nor unhappy?

30.7.16.

Page 78

When a general ethical law of the form "Thou shalt..." is set up, the first thought is: Suppose I do not do it?

Page 78

But it is clear that ethics has nothing to do with punishment and reward. So this question about the consequences of an action must be unimportant. At least these consequences cannot be events. For there must be something right about that question after all. There must be a *kind* of ethical reward and of ethical punishment but these must be involved in the action itself.

Page 78

And it is also clear that the reward must be something pleasant, the punishment something unpleasant.

Page 78

[6.422.]

Page 78

I keep on coming back to this! simply the happy life is good, the unhappy bad. And if I *now* ask myself: But why should I live *happily*, then this of itself seems to me to be a tautological question; the happy life seems to be justified, of itself, it seems that it *is* the only right life.

Page 78

But this is really in some sense deeply mysterious! *It is clear* that ethics *cannot* be expressed! [Cf. 6.421.]

Page 78

But we could say: The happy life seems to be in some sense more *harmonious* than the unhappy. But in what sense??

Page 78

What is the objective mark of the happy, harmonious life? Here it is again clear that there cannot be any such mark, that can be *described*.

Page 78

This mark cannot be a physical one but only a metaphysical one, a transcendental one.

Page Break 79

Page 79

Ethics is transcendental. [See 6.421.]

1.8.16.

Page 79

How things stand, is God.

Page 79

God is, how things stand.

Page 79

Only from the consciousness of the *uniqueness of my life* arises religion--science--and art.

2.8.16.

Page 79

And this consciousness is life itself.

Page 79

Can there be any ethics if there is no living being but myself?

Page 79

If ethics is supposed to be something fundamental, there can.

Page 79

If I am right, then it is not sufficient for the ethical judgment that a world is given.

Page 79

Then the world in itself is neither good nor evil.

Page 79

For it must be all one, as far as concerns the existence of ethics, whether there is living matter in the world or not. And it is clear that a world in which there is only dead matter is in itself neither good nor evil, so even the world of living things can in itself be neither good nor evil.

Page 79

Good and evil only enter through the *subject*. And the subject is not part of the world, but a boundary of the world. [Cf. 5.632.]

Page 79

It would be possible to say (à la Schopenhauer): It is not the world of Idea that is either good or evil; but the willing subject.

Page 79

I am conscious of the complete unclarity of all these sentences.

Page 79

Going by the above, then, the willing subject would have to be happy or unhappy, and happiness and unhappiness could not be part of the world.

Page 79

As the subject is not a part of the world but a presupposition of its existence, so good and evil which are predicates of the subject, are not properties in the world.

Page 79

Here the nature of the subject is completely veiled.

Page 79

My work has extended from the foundations of logic to the nature of the world.

Page Break 80

4.8.16.

Page 80

Isn't the thinking subject in the last resort mere superstition?

Page 80

Where in the world is a metaphysical subject to be found? [See 5.633.]

Page 80

You say that it is just as it is for the eye and the visual field. But you do *not* actually see the eye. [See 5.633.]

Page 80

And I think that nothing in the visual field would enable one to infer that it is seen from an eye. [Cf. 5.633.]

5.8.16.

Page 80

The thinking subject is surely mere illusion. But the willing subject exists. [Cf. 5.631.]

Page 80

If the will did not exist, neither would there be that centre of the world, which we call the I, and which is the bearer of ethics.

Page 80

What is good and evil is essentially the I, not the world.

Page 80

The I, the I is what is deeply mysterious!

7.8.16.

Page 80

The I is not an object.

11.8.16.

Page 80

I objectively confront every object. But not the I.

Page 80

So there really is a way in which there can and must be mention of the I in a *non-psychological sense* in philosophy. [Cf. 5.641.]

12.8.16.

Page 80

The I makes its appearance in philosophy through the world's being *my* world. [See 5.641.]

Page 80

The visual field has not, e.g., a form like this:



Page 80

[5.6331.]

Page 80

This is connected with the fact that none of our experience is *a priori*. [See 5.634.]

Page 80

All that we see could also be otherwise.

Page 80

All that we can describe at all could also be otherwise. [See 5.634.]

Page Break 81

13.8.16.

Page 81

Suppose that man could not exercise his will, but had to suffer all the misery of this world, then what could

make him happy?

Page 81

How can man be happy at all, since he cannot ward off the misery of this world?

Page 81

Through the life of knowledge.

Page 81

The good conscience is the happiness that the life of knowledge preserves.

Page 81

The life of knowledge is the life that is happy in spite of the misery of the world.

Page 81

The only life that is happy is the life that can renounce the amenities of the world.

Page 81

To it the amenities of the world are so many graces of fate.

16.8.16.

Page 81

A point cannot be red and green at the same time: at first sight there seems no need for this to be a logical impossibility. But the very language of physics reduces it to a kinetic impossibility. We see that there is a difference of structure between red and green.

Page 81

And then physics arranges them in a series. And then we see how here the true structure of the objects is brought to light.

Page 81

The fact that a particle cannot be in two places at the same time does look more like a logical impossibility.

Page 81

If we ask why, for example, then straight away comes the thought: Well, we should call particles that were in two places different, and this in its turn all seems to follow from the structure of space and of particles.

Page 81

[Cf. 6.3751.]

17.8.16.

Page 81

An operation is the transition from one term to the next one in a series of forms.

Page 81

The operation and the series of forms are equivalents.

29.8.16.

Page 81

The question is whether the usual small number of fundamental operations is adequate for the construction of all possible operations.

Page 81

It looks as if it must be so.

Page Break 82

Page 82

We can also ask whether those fundamental operations enable us to pass from any expression to any related ones.

2.9.16.

Page 82

Here we can see that solipsism coincides with pure realism, if it is strictly thought out.

Page 82

The I of solipsism shrinks to an extensionless point and what remains is the reality coordinate with it.

Page 82

[5.64.]

Page 82

What has history to do with me? Mine is the first and only world!

Page 82

I want to report how *I* found the world.

Page 82

What others in the world have told me about the world is a very small and incidental part of my experience

of the world.

Page 82

I have to judge the world, to measure things.

Page 82

The philosophical *I* is not the human being, not the human body or the human soul with the psychological properties, but the metaphysical subject, the boundary (not a part) of the world. The human body, however, my body in particular, is a part of the world among others, among beasts, plants, stones etc., etc. [Cf. 5.641.]

Page 82

Whoever realizes this will not want to procure a pre-eminent place for his own body or for the human body.

Page 82

He will regard humans and beasts quite naïvely as objects which are similar and which belong together.

11.9.16.

Page 82

The way in which language signifies is mirrored in its use.

Page 82

That the colours are not properties is shewn by the analysis of physics, by the internal relations in which physics displays the colours.

Page 82

Apply this to sounds too.

12.9.16.

Page 82

Now it is becoming clear why *I* thought that thinking and language were the same. For thinking is a kind of language. For a thought too is, of course, a logical picture of the proposition, and therefore it just is a kind of proposition.

Page Break 83

19.9.16.

Page 83

Mankind has always looked for a science in which *simplex sigillum veri* holds. [Cf. 5.4541.]

Page 83

There cannot be an orderly or a disorderly world, so that one could say that our world is orderly. In every possible world there is an order even if it is a complicated one, just as in space too there are not orderly and disorderly distributions of points, but every distribution of points is orderly.

Page 83

(This remark is only material for a thought.)

Page 83

Art is a kind of expression.

Page 83

Good art is complete expression.

7.10.16

Page 83

The work of art is the object seen *sub specie aeternitatis*; and the good life is the world seen *sub specie aeternitatis*. This is the connexion between art and ethics.

Page 83

The usual way of looking at things sees objects as it were from the midst of them, the view *sub specie aeternitatis* from outside.

Page 83

In such a way that they have the whole world as background.

Page 83

Is this it perhaps--in this view the object is seen *together with* space and time instead of *in* space and time?

Page 83

Each thing modifies the whole logical world, the whole of logical space, so to speak.

Page 83

(The thought forces itself upon one): The thing seen *sub specie aeternitatis* is the thing seen together with the whole logical space.

8.10.16.

Page 83

As a thing among things, each thing is equally insignificant; as a world each one equally significant.

Page 83

If I have been contemplating the stove, and then am told: but now all you know is the stove, my result does indeed seem trivial. For this represents the matter as if I had studied the stove as one among the many things in the world. But if I was contemplating the stove *it* was my world, and everything else colourless by contrast with it.

Page 83

(Something good about the whole, but bad in details.)

Page 83

For it is equally possible to take the bare present image as the worthless momentary picture in the whole temporal world, and as the true world among shadows.

Page Break 84

9.10.16.

Page 84

But now at last the connexion of ethics with the world has to be made clear.

12.10.16.

Page 84

A stone, the body of a beast, the body of a man, my body, all stand on the same level.

Page 84

That is why what happens, whether it comes from a stone or from my body is neither good nor bad.

Page 84

"Time has only one direction" must be a piece of nonsense.

Page 84

Having only one direction is a logical property of time.

Page 84

For if one were to ask someone how he imagines having only one direction he would say: Time would not be confined to one direction if an event could be repeated.

Page 84

But the impossibility of an event's being repeated, like that of a body's being in two places at once, is involved in the logical nature of the event.

Page 84

It is true: Man *is* the microcosm:

Page 84

I am my world. [*Cf.* 5.63.]

15.10.16.

Page 84

What cannot be imagined cannot even be talked about. [*Cf.* 5.61.]

Page 84

Things acquire "significance" only through their relation to my will.

Page 84

For "Everything is what it is and not another thing".

Page 84

One conception: As I can infer my spirit (character, will) from my physiognomy, so I can infer the spirit (will) of each thing from *its* physiognomy.

Page 84

But can I *infer* my spirit from my physiognomy?

Page 84

Isn't this relationship purely empirical?

Page 84

Does my body really express anything?

Page 84

Is it itself an internal expression of something?

Page 84

Is, e.g., an angry face angry in itself or merely because it is empirically connected with bad temper?

Page 84

But it is clear that the causal nexus is not a nexus at all. [*Cf.* 5.136.]

Now is it true (following the psycho-physical conception) that my character is expressed only in the build of *my* body or brain and not equally in the build of the whole of the rest of the world?

This contains a salient point.

This parallelism, then, really exists between my spirit, i.e. spirit, and the world.

Only remember that the spirit of the snake, of the lion, is *your* spirit. For it is only from yourself that you are acquainted with spirit at all.

Now of course the question is why I have given a snake just this spirit.

And the answer to this can only lie in the psycho-physical parallelism: If I were to look like the snake and to do what it does then I should be such-and-such.

The same with the elephant, with the fly, with the wasp.

But the question arises whether even here, my body is not on the same level with that of the wasp and of the snake (and surely it is so), so that I have neither inferred from that of the wasp to mine nor from mine to that of the wasp.

Is this the solution of the puzzle why men have always believed that there was *one* spirit common to the whole world?

And in that case it would, of course, also be common to lifeless things too.

This is the way I have travelled: Idealism singles men out from the world as unique, solipsism singles me alone out, and at last I see that I too belong with the rest of the world, and so on the one side *nothing* is left over, and on the other side, as unique, *the world*. In this way idealism leads to realism if it is strictly thought out. [Cf. 5.64.]

17.10.16.

And in this sense I can also speak of a will that is common to the whole world.

But this will is in a higher sense *my* will.

As my idea is the world, in the same way my will is the world-will.

20.10.16.

It is clear that my visual space is constituted differently in length from breadth.

The situation is not simply that I everywhere notice where I see anything, but I also always find myself at a particular point of my visual space, so my visual space has as it were a shape.

In spite of this, however, it is true that I do not see the subject.

It is true that the knowing subject is not in the world, that there is no knowing subject. [Cf. 5.631.]

At any rate I can imagine carrying out the act of will for raising my arm, but that my arm does not move. (E.g., a sinew is torn.) True, but, it will be said, the sinew surely moves and that just shews that the act of will related to the sinew and not to the arm. But let us go farther and suppose that even the sinew did not move, and so on. We should then arrive at the position that the act of will does not relate to a body at all, and so that in the ordinary sense of the word there is no such thing as the act of the will.

Page 86

Aesthetically, the miracle is that the world exists. That there is what there is.

Page 86

Is it the essence of the artistic way of looking at things, that it looks at the world with a happy eye?

Page 86

Life is grave, art is gay. †1

21.10.16.

Page 86

For there is certainly something in the conception that the end of art is the beautiful.

Page 86

And the beautiful *is* what makes happy.

29.10.16.

Page 86

Could it not be said that generality is no more co-ordinated with the complex than is fact with thing?

Page 86

Both kinds of operation sign must or can occur in the proposition side by side.

4.11.16.

Page 86

Is the will an attitude towards the world?

Page 86

The will seems always to have to relate to an idea. We cannot imagine, e.g., having carried out an act of will without having detected that we have carried it out.

Page Break 87

Page 87

Otherwise there might arise such a question as whether it had yet been *completely* carried out.

Page 87

It is clear, so to speak, that we need a foothold for the will in the world.

Page 87

The will is an attitude of the subject to the world.

Page 87

The subject is the willing subject.

Page 87

Have the feelings by which I ascertain that an act of the will takes place any particular characteristic which distinguishes them from other ideas?

Page 87

It seems not!

Page 87

In that case, however, I might conceivably get the idea that, e.g., this chair was directly obeying my will.

Page 87

Is that possible?

Page 87



In drawing the square in the mirror one notices that one is only able to manage it if one prescind completely from the visual datum and relies only on muscular feeling. So here after all there are two quite different acts of the will in question. The one relates to the visual part of the world, the other to the muscular-feeling part.

Page 87

Have we anything more than empirical evidence that the movement of the same part of the body is in question in both cases?

Page 87

Then is the situation that I merely accompany my actions with my will?

Page 87

But in that case how can I predict--as in some sense I surely can--that I shall raise my arm in five minutes' time? That I shall will this?

Page 87

This is clear: it is impossible to will without already performing the act of the will.

Page 87

The act of the will is not the cause of the action but is the action itself.

Page 87

One cannot will without acting.

Page 87

If the will has to have an object in the world, the object can be the intended action itself.

Page 87

And the will does have to have an object.

Page Break 88

Page 88

Otherwise we should have no foothold and could not know what we willed.

Page 88

And could not will different things.

Page 88

Does not the willed movement of the body happen just like any unwilled movement in the world, but that it is accompanied by the will?

Page 88

Yet it is not accompanied just by a *wish*! But by will.

Page 88

We feel, so to speak, responsible for the movement.

Page 88

My will fastens on to the world somewhere, and does not fasten on to other things.

Page 88

Wishing is not acting. But willing is acting.

Page 88

(My wish relates, e.g., to the movement of the chair, my will to a muscular feeling.)

Page 88

The fact that I will an action consists in my performing the action, not in my doing something else which causes the action.

Page 88

When I move something I move.

Page 88

When I perform an action I am in action.

Page 88

But: I cannot will everything.--

Page 88

But what does it mean to say: "I cannot will *this*"?

Page 88

Can I try to will something?

Page 88

For the consideration of willing makes it look as if one part of the world were closer to me than another (which would be intolerable).

Page 88

But, of course, it is undeniable that in a popular sense there are things that I do, and other things not done by me.

Page 88

In this way then the will would not confront the world as its equivalent, which must be impossible.

Page 88

The wish precedes the event, the will accompanies it.

Page 88

Suppose that a process were to accompany my wish. Should I have willed the process?

Page 88

Would not this accompanying appear accidental in contrast to the compelled accompanying of the will?

Page 89

Is belief a kind of experience?

Page 89

Is thought a kind of experience?

Page 89

All experience is world and does not need the subject.

Page 89

The act of will is not an experience.

19.11.16.

Page 89

What kind of reason is there for the assumption of a willing subject?

Page 89

Is not *my world* adequate for individuation?

21.11.16.

Page 89

The fact that it is possible to erect the general form of proposition means nothing but: every possible form of proposition must be FORESEEABLE.

Page 89

And *that* means: We can never come upon a form of proposition of which we could say: it could not have been foreseen that there was such a thing as this.

Page 89

For that would mean that we had had a new experience, and that it took that to make this form of proposition possible.

Page 89

Thus it must be possible to erect the general form of proposition, because the possible forms of proposition must be *a priori*. Because the possible forms of proposition are *a priori*, the general form of proposition exists.

Page 89

In this connexion it does not matter at all whether the given fundamental operations, through which all propositions are supposed to arise, change the logical level of the propositions, or whether they remain on the same logical level.

Page 89

If a sentence were ever going to be constructable it would already be constructable.

Page 89

We now need a clarification of the concept of the atomic function and the concept "and so on".

Page 89

The concept "and so on", symbolized by "...." is one of the most important of all and like all the others infinitely fundamental.

Page 89

For it alone justifies us in constructing logic and mathematics "so on" from the fundamental laws and primitive signs.

Page 89

The "and so on" makes its appearance right away at the very beginning of the old logic when it is said that after the primitive signs have been given we can develop one sign after another "so on".

Page 90

Without this concept we should be stuck at the primitive signs and could not go "on".

Page 90

The concept "and so on" and the concept of the operation are equivalent. [Cf. 5.2523.]

Page 90

After the operation sign there follows the sign "...." which signifies that the result of the operation can in its turn be taken as the base of the operation; "and so on".

22.11.16.

Page 90

The concept of the operation is quite generally that according to which signs can be constructed according to

a rule.

23.11.16.

Page 90

What does the possibility of the operation depend on?

Page 90

On the general concept of structural similarity.

Page 90

As I conceive, e.g., the elementary propositions, there must be something common to them; otherwise I could not speak of them all collectively as the "elementary propositions" at all.

Page 90

In that case, however, they must also be capable of being developed from one another as the results of operations.

Page 90

For if there really is something common to two elementary propositions which is not common to an elementary proposition and a complex one, then this common thing must be capable of being given general expression in some way.

24.11.16.

Page 90

When the general characteristic of an operation is known it will also be clear of what elementary component parts an *operation* always consists.

Page 90

When the general form of operations is found we have also found the general form of the occurrence of the concept "and so on".

26.11.16.

Page 90

All operations are composed of the fundamental operations.

28.11.16.

Page 90

Either a fact is contained in another one, or it is independent of it.

2.12.16.

Page 90

The similarity of the generality notation and the argument appears if we write $(\forall x)\phi x$ instead of ϕa . [Cf. 5.523.]

Page Break 91

Page 91

We could introduce the arguments also in such a way that they only occurred on one side of the sign of identity, i.e. always on the analogy of " $(\exists x).\phi x.x = a$ " instead of " ϕa ".

Page 91

The correct method in philosophy would really be to say nothing except what can be said, i.e. what belongs to natural science, i.e. something that has nothing to do with philosophy, and then whenever someone else tried to say something metaphysical to shew him that he had not given any reference to certain signs in his sentences. [See 6.53.]

Page 91

This method would be unsatisfying for the other person (he would not have the feeling that we were teaching him philosophy) but it would be the only correct one. [See 6.53.]

7.1.17.

Page 91

In the sense in which there is a hierarchy of propositions there is, of course, also a hierarchy of truths and of negations, etc.

Page 91

But in the sense in which there are, in the most general sense, such things as propositions, there is only one truth and one negation.

Page 91

The latter sense is obtained from the former by conceiving the proposition in general as the result of the single operation which produces all propositions from the first level. Etc.

Page 91

The lowest level and the operation can stand for the whole hierarchy.

8.1.17.

Page 91

It is clear that the logical product of two elementary propositions can never be a tautology. [*Cf.* 6.3751.]

Page 91

If the logical product of two propositions is a contradiction, and the propositions appear to be elementary propositions, we can see that in this case the appearance is deceptive. (E.g.: A is red and A is green.)

10.1.17.

Page 91

If suicide is allowed then everything is allowed.

Page 91

If anything is not allowed then suicide is not allowed.

Page 91

This throws a light on the nature of ethics, for suicide is, so to speak, the elementary sin.

Page 91

And when one investigates it it is like investigating mercury vapour in order to comprehend the nature of vapours.

Page 91

Or is even suicide in itself neither good nor evil?

Page Break 92

Page Break 93

APPENDIX I
NOTES ON LOGIC
 by
 Ludwig Wittgenstein
 1913

SUMMARY

Page 93

ONE reason for thinking the old notation wrong is that it is very unlikely that from every proposition p an infinite number of other propositions not-not-p, not-not-not-not-p, etc., should follow. [*Cf.* 5.43.]

Page 93

If only those signs which contain proper names were complex then propositions containing nothing but apparent variables would be simple. Then what about their denials?

Page 93

The verb of a proposition cannot be "is true" or "is false", but whatever is true or false must already contain the verb. [*See* 4.063.]

Page 93

Deductions only proceed according to the laws of deduction but these laws cannot justify the deduction.

Page 93

One reason for supposing that not all propositions which have more than one argument are relational propositions is that if they were, the relations of judgment and inference would have to hold between an arbitrary number of things.

Page 93

Every proposition which seems to be about a complex can be analysed into a proposition about its constituents and about the proposition which describes the complex perfectly; i.e., that proposition which is equivalent to saying the complex exists. [*Cf.* 2.0201.]

Page 93

The idea that propositions are names of complexes suggests that whatever is not a proper name is a sign for a relation. Because spatial complexes†1 consist of Things and Relations only and the idea of a complex is taken from space.

Page 93

In a proposition convert all its indefinables into variables; there then remains a class of propositions which is

not all propositions but a type [Cf. 3.315.]

Page 93

There are thus two ways in which signs are similar. The names "Socrates" and "Plato" are similar: they are both names. But whatever they have in common must not be introduced before "Socrates" and "Plato" are introduced. The same applies to a subject-predicate form etc.. Therefore, thing, proposition, subject-predicate forth, etc., are not indefinables, i.e., types are not indefinables.

Page Break 94

Page 94

When we say A judges that etc., then we have to mention a whole proposition which A judges. It will not do either to mention only its constituents, or its constituents and form, but not in the proper order. This shows that a proposition itself must occur in the statement that it is judged; however, for instance, "not-p" may be explained, the question what is negated must have a meaning.

Page 94

To understand a proposition p it is not enough to know that p implies "' p ' is true', but we must also know that $\sim p$ implies " p is false". This shows the bi-polarity of the proposition.

Page 94

To every molecular function a $WF\uparrow 1$ scheme corresponds. Therefore we may use the WF scheme itself instead of the function. Now what the WF scheme does is, it correlates the letters W and F with each proposition. These two letters are the poles of atomic propositions. Then the scheme correlates another W and F to these poles. In this notation all that matters is the correlation of the outside poles to the poles of the atomic propositions. Therefore not-not- p is the same symbol as p . And therefore we shall never get two symbols for the same molecular function.

Page 94

The meaning of a proposition is the fact which actually corresponds to it.

Page 94

As the ab functions of atomic propositions are bi-polar propositions again we can perform ab operations on them. We shall, by doing so, correlate two new outside poles via the old outside poles to the poles of the atomic propositions.

Page 94

The symbolising fact in $a-p-b$ is that, $SA Y\uparrow 2$ a is on the left of p and b on the right of p ; then the correlation of new poles is to be transitive, so that for instance if a new pole a in whatever way i.e. via whatever poles is correlated to the inside a , the symbol is not changed thereby. It is therefore possible to construct all possible ab functions by performing one ab operation repeatedly, and we can therefore talk of all ab functions as of all those functions which can be obtained by performing this ab operation repeatedly.

Page 94

Naming is like pointing. A function is like a line dividing points of a plane into right and left ones; then " p or not- p " has no meaning because it does not divide the plane.

Page 94

But though a particular proposition " p or not- p " has no meaning, a general proposition "for all p 's, p or not- p " has a meaning because this

Page Break 95

does not contain the nonsensical function " p or not- p " but the function " p or not- q " just as "for all x 's xRx " contains the function " xRy ".

Page 95

A proposition is a standard to which facts behave, $\uparrow 1$ with names it is otherwise; it is thus bi-polarity and sense comes in; just as one arrow behaves $\uparrow 2$ to another arrow by being in the same sense or the opposite, so a fact behaves to a proposition.

Page 95

The form of a proposition has meaning in the following way. Consider a symbol " xRy ". To symbols of this form correspond couples of things whose names are respectively " x " and " y ". The things xy stand to one another in all sorts of relations, amongst others some stand in the relation R , and some not; just as I single out a particular thing by a particular name I single out all behaviours of the points x and y with respect to the relation R . I say that if an x stands in the relation R to a y the sign " xRy " is to be called true to the fact and otherwise false. This is a definition of

sense.

Page 95

In my theory p has the same meaning as $\text{not-}p$ but opposite sense. The meaning is the fact. The proper theory of judgment must make it impossible to judge nonsense. [Cf. 4.0621 and 5.5422.]

Page 95

It is not strictly true to say that we understand a proposition p if we know that p is equivalent to " p is true" for this would be the case if accidentally both were true or false. What is wanted is the formal equivalence with respect to the forms of the proposition, *i.e.*, all the general indefinables involved. The *sense of an ab function of a proposition* is a function of *its* sense. There are only unasserted propositions. Assertion is merely psychological. In *not- p* , p is exactly the same as if it stands alone; this point is absolutely fundamental. Among the facts which make " p or q " true there are also facts which make " p and q " true; if propositions have only meaning, we ought, in such a case, to say that these two propositions are identical, but in fact, their sense is different for we have introduced sense by talking of all p 's and all q 's. Consequently the molecular propositions will only be used in cases where their *ab* function stands under a generality sign or enters into another function such as "I believe that, etc.", because then the sense enters. [Cf. 5.2341.]

Page 95

In " a judges p " p cannot be replaced by a proper name. This appears if we substitute " a judges that p is true and $\text{not } p$ is false". The proposition " a judges p " consists of the proper name a , the proposition p with its 2 poles, and a being related to both of these poles in a certain way. This is obviously not a relation in the ordinary sense.

Page 95

The *ab* notation makes it clear that *not* and *or* are dependent on one another and we can therefore not use them as simultaneous indefinables.

Page Break 96

Same objections in the case of apparent variables to old indefinables, as in the case of molecular functions. The application of the *ab* notation to apparent variable propositions becomes clear if we consider that, for instance, the proposition " $\text{for all } x, \phi x$ " is to be true when ϕx is true for all x 's and false when ϕx is false for some x 's. We see that *some* and *all* occur simultaneously in the proper apparent variable notation.

Page 96

The notation is

for $(x)\phi x$: $a-(x)-a\phi xb-(\exists x)-b$ and
for $(\exists x)\phi x$: $a-(\exists x)-a\phi xb-(x)-b$

Page 96

Old definitions now become tautologous.

Page 96

In " aRb " it is not the complex that symbolises but the fact that the symbol " a " stands in a certain relation to the symbol " b ". Thus facts are symbolised by facts, or more correctly: that a certain thing is the case in the symbol says that a certain thing is the case in the world. [Cf. 3.1432.]

Page 96

Judgment, question and command are all on the same level. What interests logic in them is only the unasserted proposition. Facts cannot be named.

Page 96

A proposition cannot occur in itself. This is the fundamental truth of the theory of types. [Cf. 3.332.]

Page 96

Every proposition that says something indefinable about one thing is a subject-predicate proposition, and so on.

Page 96

Therefore we can recognize a subject-predicate proposition if we know it contains only one name and one form, etc. This gives the construction of types. Hence the type of a proposition can be recognized by its symbol alone.

Page 96

What is essential in a correct apparent-variable notation is this: (1) it must mention a type of propositions; (2) it must show which components of a proposition of this type are constants.

Page 96

[Components are forms and constituents.]

Take $(\phi).\phi!x$. Then if we describe the *kind* of symbols, for which " $\phi!$ " stands and which, by the above, is enough to determine the type, then automatically " $(\phi).\phi!x$ " cannot be fitted by this description, because it *CONTAINS* " $\phi!x$ " and the description is to describe *ALL* that symbolises in symbols of the $\phi!$ kind. If the description is *thus* complete vicious circles can just as little occur as for instance $(\phi).(x)\phi$ (where $(x)\phi$ is a subject-predicate proposition).

FIRST MS

Indefinables are of two sorts: names, and forms. Propositions cannot consist of names alone; they cannot be classes of names. A name can not only occur in two different propositions, but can occur in the same way in both.

Propositions [which are symbols having reference to facts] are themselves facts: that this inkpot is on this table may express that I sit in this chair. [Cf. 2.141 and 3.14.]

It can never express the common characteristic of two objects that we designate them by the same name but by two different ways of designation, for, since names are arbitrary, we might also choose different names, and where then would be the common element in the designations? Nevertheless one is always tempted, in a difficulty, to take refuge in different ways of designation. [Cf. 3.322.]

Frege said "propositions are names"; Russell said "propositions correspond to complexes". Both are false; and especially false is the statement "propositions are names of complexes". [Cf. 3.143.]

It is easy to suppose that only such symbols are complex as contain names of objects, and that accordingly " $(\exists x, \phi).\phi x$ " or " $(\exists x, y).xRy$ " must be simple. It is then natural to call the first of these the name of a form, the second the name of a relation. But in that case what is the meaning of (e.g.) " $\sim(\exists x, y)xRy$ "? Can we put "not" before a name?

The reason why " \sim Socrates" means nothing is that " $\sim x$ " does not express a property of x .

There are positive and negative facts: if the proposition "this rose is not red" is true, then what it signifies is negative. But the occurrence of the word "not" does not indicate this unless we know that the signification of the proposition "this rose is red" (when it is true) is positive. It is only from both, the negation and the negated proposition, that we can conclude to a characteristic of the significance of the whole proposition. (We are not here speaking of negations of *general* propositions i.e. of such as contain apparent variables. Negative facts only justify the negations of atomic propositions.)

Positive and *negative* facts there are, but not *true* and *false* facts.

If we overlook the fact that propositions have a *sense* which is independent of their truth or falsehood, it easily seems as if true and false were two equally justified relations between the sign and what is signified. (We might then say e.g. that " q " *signifies* in the true way what " $\text{not-}q$ " *signifies* in the false way.) But are not true and false in fact equally justified? Could we not express ourselves by means of false propositions just as well as hitherto with true ones, so long as we know that they are meant falsely? No! For a proposition is then true when it is as we assert in this proposition; and accordingly if by " q " we mean " $\text{not-}q$ ", and it is as we mean to assert, then in the new interpretation " q " is actually true and *not* false. But it is important that we *can* mean the same by " q " as by " $\text{not-}q$ ", for it shows that neither to the symbol "not" nor to the manner of its combination with " q " does a

characteristic of the denotation of " q " correspond. [Cf. 4.061, 4.062, 4.0621.]

SECOND MS

We must be able to understand propositions which we have never heard before. But every proposition is a new symbol. Hence we must have *general* indefinable symbols; these are unavoidable if propositions are not all indefinable. [Cf. 4.02, 4.021, 4.027.]

Page 98

Whatever corresponds in reality to compound propositions must not be more than what corresponds to their several atomic propositions.

Page 98

Not only must logic not deal with [particular] things, but just as little with relations and predicates.

Page 98

There are no propositions containing real variables.

Page 98

What corresponds in reality to a proposition depends upon whether it is true or false. But we must be able to understand a proposition without knowing if it is true or false.

Page 98

What we know when we understand a proposition is this: We know what is the case if the proposition is true, and what is the case if it is false. But we do not know (necessarily) whether it is true or false. [Cf. 4.024.]

Page 98

Propositions are not names.

Page 98

We can never distinguish one logical type from another by attributing a property to members of the one which we deny to members of the other.

Page 98

Symbols are not what they seem to be. In " aRb ", " R " looks like a substantive, but is not one. What symbolizes in " aRb " is that R occurs between a and b . Hence " R " is *not* the indefinable in " aRb ". Similarly in " ϕx ", " ϕ " looks like a substantive but is not one; in " $\sim p$ ", " \sim " looks like " ϕ " but is not like it. This is the first thing that indicates that there *may* not be logical constants. A reason against them is the generality of logic: logic cannot treat a special set of things. [Cf. 3.1423.]

Page 98

Molecular propositions contain nothing beyond what is contained in their atoms; they add no material information above that contained in their atoms.

Page 98

All that is essential about molecular functions is their T-F schema (i.e. the statement of the cases when they are true and the cases when they are false).

Page 98

Alternative indefinability shows that the indefinables have not been reached.

Page 98

Every proposition is essentially true-false: to understand it, we must know both what must be the case if it is true, and what must be the case if it is false. Thus a proposition has two *poles*, corresponding to the

Page Break 99

case of its truth and the case of its falsehood. We call this the *sense* of a proposition.

Page 99

In regard to notation, it is important to note that not every feature of a symbol symbolizes. In two molecular functions which have the same T-F schema, what symbolizes must be the same. In "not-not- p ", "not- p " does not occur; for "not-not- p " is the same as " p ", and therefore, if "not- p " occurred in "not-not- p ", it would occur in " p ".

Page 99

Logical indefinables cannot be predicates or relations, because propositions, owing to sense, cannot have predicates or relations. Nor are "not" and "or", like judgment, *analogous* to predicates or relations, because they do not introduce anything new.

Page 99

Propositions are always complex even if they contain no names.

Page 99

A proposition must be understood when *all* its indefinables are understood. The indefinables in " aRb " are introduced as follows:

Page 99

" a " is indefinable;

Page 99

" b " is indefinable;

Page 99

Whatever " x " and " y " may mean, " xRy " says something indefinable about their meaning. [Cf. 4.024.]

A complex symbol must never be introduced as a single indefinable. [Thus e.g. no proposition is indefinable.] For if one of its parts occurs also in another connection, it must there be re-introduced. And would it then mean the same?

The ways by which we introduce our indefinables must permit us to construct all propositions that have sense from these indefinables *alone*. It is easy to introduce "all" and "some" in a way that will make the construction of (say) "(x,y).xRy" possible from "all" and "xRy" *as introduced before*.

THIRD MS

An analogy for the theory of truth: Consider a black patch on white paper; then we can describe the form of the patch by mentioning, for each point of the surface, whether it is white or black. To the fact that a point is black corresponds a positive fact, to the fact that a point is white (not black) corresponds a negative fact. If I designate a point of the surface (one of Frege's "truth-values"), this is as if I set up an assumption to be decided upon. But in order to be able to say of a point that it is black or that it is white, I must first know when a point is to be called black and when it is to be called white. In order to be able to say that "p" is true (or false), I must first have determined under what circumstances I call a proposition true, and thereby I determine the *sense* of a proposition. The point in which the analogy fails is this: I can indicate a point of the paper which is white and black,†1 but to a

proposition without sense nothing corresponds, for it does not designate a thing (truth-value), whose properties might be called "false" or "true"; the verb of a proposition is not "is true" or "is false", as Frege believes, but what is true must already contain the verb. [Cf. 5.132.]

The comparison of language and reality is like that of retinal image and visual image: to the blind spot nothing in the visual image seems to correspond, and thereby the boundaries of the blind spot determine the visual image--as true negations of atomic propositions determine reality.

Logical inferences can, it is true, be made in accordance with Frege's or Russell's laws of deduction, but this cannot justify the inference; and therefore they are not primitive propositions of logic. If p follows from q , it can also be inferred from q , and the "manner of deduction" is indifferent.

Those symbols which are called propositions in which "variables occur" are in reality not propositions at all, but only schemes of propositions, which only become propositions when we replace the variables by constants. There is no proposition which is expressed by " $x = x$ ", for " x " has no signification; but there is a proposition " $(x).x = x$ " and propositions such as "Socrates = Socrates" etc.

In books on logic, no variables ought to occur, but only the general propositions which justify the use of variables. It follows that the so-called definitions of logic are not definitions, but only schemes of definitions, and instead of these we ought to put general propositions; and similarly the so-called primitive ideas (*Urzeichen*) of logic are not primitive ideas, but the schemes of them. The mistaken idea that there are things called facts or complexes and relations easily leads to the opinion that there must be a relation of questioning to the facts, and then the question arises whether a relation can hold between an arbitrary number of things, since a fact can follow from arbitrary cases. It is a fact that the proposition which e.g. expresses that q follows from p and $p \supset q$ is this: $p.p \supset q.$
 $\supset p.q.q.$

At a pinch, one is tempted to interpret "not- p " as "everything else, only not p ". That from a single fact p an infinity of others, not-not- p etc., follow, is hardly credible. Man possesses an innate capacity for constructing symbols with which *some* sense can be expressed, without having the slightest idea what each word signifies. The best example of this is mathematics, for man has until lately used the symbols for numbers without knowing what they signify or that they signify nothing. [Cf. 5.43.]

Russell's "complexes" were to have the useful property of being compounded, and were to combine with this the agreeable property that they could be treated like "simples". But this alone made them

unserviceable as logical types, since there would have been significance in asserting, of a simple, that it was complex. But a *property* cannot be a logical type.

Every statement about apparent complexes can be resolved into the logical sum of a statement about the constituents and a statement about the proposition which describes the complex completely. How, in each case, the resolution is to be made, is an important question, but its answer is not unconditionally necessary for the construction of logic. [Cf. 2.0201.]

That "or" and "not" etc. are not relations in the same sense as "right" and "left" etc., is obvious to the plain man. The possibility of cross-definitions in the old logical indefinables shows, of itself, that these are not the right indefinables, and, even more conclusively, that they do not denote relations. [Cf. 5.42.]

If we change a constituent a of a proposition $\phi(a)$ into a variable, then there is a class

$$\hat{P}\{(\exists x).\phi(x) = p\}$$

This class in general still depends upon what, by an *arbitrary convention*, we mean by " $\phi(x)$ ". But if we change into variables all those symbols whose significance was arbitrarily determined, there is still such a class. But this is not dependent upon any convention, but only upon the nature of the symbol " $\phi(x)$ ". It corresponds to a logical type. [Cf. 3.315.]

Types can never be distinguished from each other by saying (as is often done) that one has these *but* the other has those properties, for this presupposes that there is a *meaning* in asserting all these properties of both types. But from this it follows that, at best, these properties may be types, but certainly not the objects of which they are asserted. [Cf. 4.1241.]

At a pinch we are always inclined to explanations of logical functions of propositions which aim at introducing into the function either only the constituents of these propositions, or only their form, etc. etc.; and we overlook that ordinary language would not contain the whole propositions if it did not need them: However, e.g., "not p " may be explained, there must always be a meaning given to the question "what is denied?"

The very possibility of Frege's explanations of "not- p " and "if p then q ", from which it follows that "not-not- p " denotes the same as p , makes it probable that there is some method of designation in which "not-not- p " corresponds to the same symbol as " p ". But if this method of designation suffices for logic, it must be the right one.

Names are points, propositions arrows--they have *sense*. The sense

of a proposition is determined by the two poles *true* and *false*. The form of a proposition is like a straight line, which divides all points of a plane into right and left. The line does this automatically, the form of proposition only by convention. [Cf. 3.144.]

Just as little as we are concerned, in logic, with the relation of a name to its meaning, just so little are we concerned with the relation of a proposition to reality, but we want to know the meaning of names and the sense of propositions--as we introduce an indefinable concept "A" by saying: "'A' denotes something indefinable", so we introduce e.g. the form of propositions aRb by saying: "For all meanings of "x" and "y", "xRy" expresses something indefinable about x and y".

In place of every proposition " p ", let us write " $\hat{b}P$ ": Let every correlation of propositions to each other or of names to propositions be effected by a correlation of their poles "a" and "b". Let this correlation be transitive. Then accordingly " $\hat{b} = \hat{b}P$ " is the same symbol as " $\hat{b}P$ ". Let n propositions be given. I then call a "class of poles" of these propositions every class of n members, of which each is a pole of one of the n propositions, so that one member corresponds to each proposition. I then correlate with each class of poles one of two poles (a and b). The sense of the symbolizing fact thus constructed I cannot define, but I know it.

If $p = \text{not-not-}p$ etc., this shows that the traditional method of symbolism is wrong, since it allows a plurality of symbols with the same sense; and thence it follows that, in analyzing such propositions, we must not be guided by Russell's method of symbolizing.

Page 102

It is to be remembered that names are not things, but classes: "A" is the same letter as "A". This has the most important consequences for every symbolic language. [Cf. 3.203].

Page 102

Neither the sense nor the meaning of a proposition is a thing. These words are incomplete symbols.

Page 102

It is impossible to dispense with propositions in which the same argument occurs in different positions. It is obviously useless to replace $\phi(a,a)$ by $\phi(a,b).a = b$.

Page 102

Since the *ab*-functions of *p* are again bi-polar propositions, we can form *ab*-functions of them, and so on. In this way a series of propositions will arise, in which in general the *symbolizing* facts will be the same in several members. If now we find an *ab*-function of such a kind that by repeated application of it every *ab*-function can be generated, then we can introduce the totality of *ab*-functions as the totality of those that are generated by application of this function. Such a function is $\sim p \vee \sim q$.

Page 102

It is easy to suppose a contradiction in the fact that on the one hand every possible complex proposition is a simple *ab*-function of simple

Page Break 103

propositions, and that on the other hand the repeated application of one *ab*-function suffices to generate all these propositions. If e.g. an affirmation can be generated by double negation, is negation in any sense contained in affirmation? Does "p" deny "not-p" or assert "p", or both? And how do matters stand with the definition of " \supset " by " \vee " and ".", or of " \vee " by "." and " \supset "? And how e.g. shall we introduce $p|q$ (i.e. $\sim p \vee \sim q$), if not by saying that this expression says something indefinable about all arguments *p* and *q*? But the *ab*-functions must be introduced as follows: The function $p|q$ is merely a mechanical instrument for constructing all possible *symbols* of *ab*-functions. The symbols arising by repeated application of the symbol "|" do *not* contain the symbol " $p|q$ ". We need a rule according to which we can form all symbols of *ab* functions, in order to be able to speak of the class of them; and now we speak of them e.g. as those symbols of functions which can be generated by repeated application of the operation "|". And we say now: For all *p*'s and *q*'s, " $p|q$ " says something indefinable about the sense of those simple propositions which are contained in *p* and *q*. [Cf. 5.44.]

Page 103

The assertion-sign is logically quite without significance. It only shows, in Frege and Whitehead and Russell, that these authors hold the propositions so indicated to be true. " \vdash " therefore belongs as little to the proposition as (say) the number of the proposition. A proposition cannot possibly assert of itself that it is true. [Cf. 4.442.]

Page 103

Every right theory of judgment must make it impossible for me to judge that this table penholders the book. Russell's theory does not satisfy this requirement. [See 5.5422.]

Page 103

It is clear that we understand propositions without knowing whether they are true or false. But we can only know the *meaning* of a proposition [[sic]] when we know if it is true or false. What we understand is the *sense* of the proposition. [Cf. 4.024.]

Page 103

The assumption of the existence of logical objects makes it appear remarkable that in the sciences propositions of the form " $p \vee q$ ", " $p \supset q$ ", etc. are only then not provisional when " \vee " and " \supset " stand within the scope of a generality-sign [apparent variable].

FOURTH MS

Page 103

If we formed all possible atomic propositions, the world would be completely described if we declared the truth or falsehood of each. [Cf. 4.26.]

Page 103

The chief characteristic of my theory is that, in it, *p* has the same *meaning* as not-*p*. [Cf. 4.0621.]

Page 103

A false theory of relations makes it easily seem as if the relation of

fact and constituent were the same as that of fact and fact which follows from it. But the similarity of the two may be expressed thus:

$$\phi a. \supset_{\phi, a} a = a.$$

If a word creates a world so that in it the principles of logic are true, it thereby creates a world in which the whole of mathematics holds; and similarly it could not create a world in which a proposition was true, without creating its constituents. [Cf. 5.123.]

Signs of the form " $p \vee \sim p$ " are senseless, but not the proposition " $(p).p \vee \sim p$ ". If I know that this rose is either red or not red, I know nothing. The same holds of all *ab*-functions. [Cf. 4.461.]

To understand a proposition means to know what is the case if it is true. Hence we can understand it without knowing if it is true. We understand it when we understand its constituents and forms. If we know the meaning of "a" and "b", and if we know what "xRy" means for all x's and y's, then we also understand "aRb". [Cf. 4.024.]

I understand the proposition "aRb" when I know that either the fact that aRb or the fact that not aRb corresponds to it; but this is not to be confused with the false opinion that I understood "aRb" when I know that "aRb or not aRb" is the case.

But the form of a proposition symbolizes in the following way: Let us consider symbols of the form "xRy"; to these correspond primarily pairs of objects, of which one has the name "x", the other the name "y". The x's and y's stand in various relations to each other, among others the relation R holds between some, but not between others. I now determine the sense of "xRy" by laying down: when the facts behave in regard to \dagger 1 "xRy" so that the meaning of "x" stands in the relation R to the meaning of "y", then I say that the [the facts] are "of like sense" ["gleichsinnig"] with the proposition "xRy"; otherwise, "of opposite sense" [entgegengesetzt]; I correlate the facts to the symbol "xRy" by thus dividing them into those of like sense and those of opposite sense. To this correlation corresponds the correlation of name and meaning. Both are psychological. Thus I understand the form "xRy" when I know that it discriminates the behaviour of x and y according as these stand in the relation R or not. In this way I extract from all possible relations the relation R, as, by a name, I extract its meaning from among all possible things.

Strictly speaking, it is incorrect to say: we understand the proposition p when we know that " p is true" $\equiv p$; for this would naturally always be the case if accidentally the propositions to right and left of the symbol " \equiv " were both true or both false. We require not only an

equivalence, but a formal equivalence, which is bound up with the introduction of the form of p .

The sense of an *ab*-function of p is a function of the sense of p . [Cf. 5.2341.]

The *ab*-functions use the discrimination of facts, which their arguments bring forth, in order to generate new discriminations.

Only facts can express sense, a class of names cannot. This is easily shown.

There is no thing which is the form of a proposition, and no name which is the name of a form. Accordingly we can also not say that a relation which in certain cases holds between things holds sometimes between forms and things. This goes against Russell's theory of judgment.

It is very easy to forget that, though the propositions of a form can be either true or false, each one of these propositions can only be either true or false, not both.

Among the facts which make " p or q " true, there are some which make " p and q " true; but the class which makes " p or q " true is different from the class which makes " p and q " true; and only this is what matters. For we

introduce this class, as it were, when we introduce *ab*-functions. [Cf. 5.1241.]

Page 105

A very natural objection to the way in which I have introduced e.g. propositions of the form xRy is that by it propositions such as $(\exists x.y).xRy$ and similar ones are not explained, which yet obviously have in common with aRb what cRd has in common with aRb . *But* when we introduce propositions of the form xRy we mentioned no one particular proposition of this form; and we only need to introduce $(\exists x,y).\phi(x,y)$ for all ϕ 's in any way which makes the sense of these propositions dependent on the sense of all propositions of the form $\phi(a,b)$, and thereby the justness of our procedure is proved.

Page 105

The indefinables of logic must be independent of each other. If an indefinable is introduced, it must be introduced in all combinations in which it can occur. We cannot therefore introduce it first for one combination, then for another; e.g., if the form xRy has been introduced it must henceforth be understood in propositions of the form aRb just in the same way as in propositions such as $(\exists x,y).xRy$ and others. We must not introduce it first for one class of cases, then for the other; for it would remain doubtful if its meaning was the same in both cases, and there would be no ground for using the same matter of combining symbols in both cases. In short for the introduction of indefinable symbols and combinations of symbols the same holds, *mutatis mutandis*, that Frege has said for the introduction of symbols by definitions. [Cf. 5.451.]

Page Break 106

Page 106

It is *a priori* likely that the introduction of atomic propositions is fundamental for the understanding of all other kinds of propositions. In fact the understanding of general propositions obviously depends on that of atomic propositions.

Page 106

Cross-definability in the realm of general propositions leads to quite similar questions to those in the realm of *ab*-functions.

Page 106

When we say "A believes p ", this sounds, it is true, as if here we could substitute a proper name for " p "; but we can see that here a *sense*, not a meaning, is concerned, if we say "A believes that ' p ' is true"; and in order to make the direction of p even more explicit, we might say "A believes that ' p ' is true and 'not- p ' is false". Here the bipolarity of p is expressed, and it seems that we shall only be able to express the proposition "A believes p " correctly by the *ab*-notation; say by making "A" have a relation to the poles "a" and "b" of a- p -b. The epistemological questions concerning the nature of judgment and belief cannot be solved without a correct apprehension of the form of the proposition.

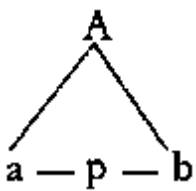

Page 106

The *ab*-notation shows the dependence of *or* and *not*, and thereby that they are not to be employed as simultaneous indefinables.

Page 106

Not: "The complex sign 'ago'" says that a stands in the relation R to b ; but *that* ' a ' stands in a certain relation to ' b ' says *that* aRb . [3.1432.]

Page 106

In philosophy there are no deductions: *it* is purely descriptive.

Page 106

Philosophy gives no pictures of reality.

Page 106

Philosophy can neither confirm nor confute scientific investigation.

Page 106

Philosophy consists of logic and metaphysics: logic is its basis.

Page 106

Epistemology is the philosophy of psychology. [Cf. 4.1121.]

Page 106

Distrust of grammar is the first requisite for philosophizing.

Page 106

Propositions can never be indefinables, for they are always complex. That also words like "ambulo" are complex appears in the fact that their root with a different termination gives a different sense. [Cf. 4.032.]

Page 106

Only the doctrine of general indefinables permits us to understand the nature of functions. Neglect of this doctrine leads to an impenetrable thicket.

Page 106

Philosophy is the doctrine of the logical form of scientific propositions (not only of primitive propositions).

Page 106

The word "philosophy" ought always to designate something over or under but not beside, the natural sciences. [Cf. 4.111.]

Page Break 107

Page 107

Judgment, command and question all stand on the same level; but all have in common the propositional form, which does interest *us*.

Page 107

The structure of the proposition must be recognized, the rest comes of itself. But ordinary language conceals the structure of the proposition: in it, relations look like predicates, predicates like names, etc.

Page 107

Facts cannot be *named*.

Page 107

It is easy to suppose that "individual", "particular", "complex" etc. are primitive ideas of logic. Russell e.g. says "individual" and "matrix" are "primitive ideas". This error presumably is to be explained by the fact that, by employment of variables instead of the generality-sign, it comes to seem as if logic dealt with things which have been deprived of all properties except thing-hood, and with propositions deprived of all properties except complexity. We forget that the indefinables of symbols [*Urbilder von Zeichen*] only occur under the generality-sign, never outside it.

Page 107

Just as people used to struggle to bring all propositions into the subject-predicate form, so now it is natural to conceive every proposition as expressing a relation, which is just as incorrect. What is justified in this desire is fully satisfied by Russell's theory of manufactured relations.

Page 107

One of the most natural attempts at solution consists in regarding "not-*p*" as "the opposite of *p*", where then "opposite" would be the indefinable relation. But it is easy to see that every such attempt to replace the *ab*-functions by descriptions must fail.

Page 107

The false assumption that propositions are names leads us to believe that there must be logical objects: for the meanings of logical propositions will have to be such things.

Page 107

A correct explanation of logical propositions must give them a unique position as against all other propositions.

Page 107

No proposition can say anything about itself, because the symbol of the proposition cannot be contained in itself; this must be the basis of the theory of logical types. [Cf. 3.332.]

Page 107

Every proposition which says something indefinable about a thing is a subject-predicate proposition; every proposition which says something indefinable about two things expresses a dual relation between these things, and so on. Thus every proposition which contains only one name and one indefinable form is a subject-predicate proposition, and so on. An indefinable simple symbol can only be a name, and therefore we can know, by the symbol of an atomic proposition, whether it is a subject-predicate proposition.

Page Break 108

APPENDIX II

NOTES DICTATED TO G. E. MOORE IN NORWAY†1

Page 108

LOGICAL so-called propositions *shew* [the] logical properties of language and therefore of [the] Universe, but *say* nothing. [Cf. 6.12.]

Page 108

This means that by merely looking at them you can *see* these properties; whereas, in a proposition proper, you cannot see what is true by looking at it. [Cf. 6.113.]

Page 108

It is impossible to *say* what these properties are, because in order to do so, you would need a language, which hadn't got the properties in question, and it is impossible that this should be a *proper* language. Impossible to construct [an] illogical language.

Page 108

In order that you should have a language which can express or *say* everything that *can* be said, this language must have certain properties; and when this is the case, *that* it has them can no longer be said in that language or *any* language.

Page 108

An illogical language would be one in which, e.g., you could put an *event* into a hole.

Page 108

Thus a language which *can* express everything *mirrors* certain properties of the world by these properties which it must have; and logical so-called propositions *shew in a systematic way* those properties.

Page 108

How, usually, logical propositions do *shew* these properties is this: We give a certain description of a kind of symbol; we find that other symbols, combined in certain ways, yield a symbol of this description; and *that* they do *shews* something about these symbols.

Page 108

As a rule the description given in ordinary Logic is the description of a tautology; but *others* might *shew* equally well, e.g., a contradiction. [Cf. 6.1202.]

Page 108

Every *real* proposition *shews* something, besides what it says, about the Universe: *for*, if it has no sense, it can't be used; and if it has a sense, it mirrors some logical property of the Universe.

Page 108

E.g., take ϕa , $\phi a \supset \psi a$, ψa . By merely looking at these three, I can see that 3 follows from 1 and 2; i.e. I can see what is called the truth of a logical proposition, namely, of [the] proposition $\phi a. \phi a \supset \psi a: \supset: \psi a$. But this is *not* a proposition; but by seeing that it is a tautology I can

Page Break 109

see what I already saw by looking at the three propositions: the difference is that I *now* see THAT it is a tautology. [Cf. 6.1221.]

Page 109

We want to say, in order to understand [the] above, what properties a symbol must have, in order to be a tautology.

Page 109

Many ways of saying this are possible:

Page 109

One way is to give *certain symbols*; then to give a set of rules for combining them; and then to say: any symbol formed from those symbols, by combining them according to one of the given rules, is a tautology. This obviously says something about the kind of symbol you can get in this way.

Page 109

This is the actual procedure of [the] *old* Logic: it gives so-called primitive propositions; so-called rules of deduction; and then says that what you get by applying the rules to the propositions is a *logical* proposition that you have *proved*. The truth is, it tells you something *about* the kind of proposition you have got, viz that it can be derived from the first symbols by these rules of combination (= is a tautology).

Page 109

Therefore, if we say one *logical* proposition *follows* logically from another, this means something quite different from saying that a *real* proposition follows logically from *another*. For so-called *proof* of a logical proposition does not prove its *truth* (logical propositions are neither true nor false) but proves *that* it is a logical

proposition = is a tautology. [Cf. 6.1263.]

Page 109

Logical propositions *are forms of proofs*: they shew that one or more propositions *follow* from one (or more). [Cf. 6.1264.]

Page 109

Logical propositions *shew* something, *because* the language in which they are expressed can *say* everything that can be *said*.

Page 109

This same distinction between what can be *shewn* by the language but not *said*, explains the difficulty that is felt about types--e.g., as to [the] difference between things, facts, properties, relations. That M is a *thing* can't be *said*; it is nonsense: but *something* is *shewn* by the symbol "M". In [the] same way, that a *proposition* is a subject-predicate proposition can't be said: but it is *shown* by the symbol.

Page 109

Therefore a THEORY *of types* is impossible. It tries to say something about the types, when you can only talk about the symbols. But *what* you say about the symbols is not that this symbol has that type, which would be nonsense for [the] same reason: but you say simply: *This* is the symbol, to prevent a misunderstanding. E.g., in "aRb", "R" is *not* a symbol, but *that* "R" is between one name and another symbolizes. Here we have *not* said: this symbol is not of this type but of that, but only: *This* symbolizes and not that. This seems again to make the same

Page Break 110

mistake, because "symbolizes" is "typically ambiguous". The true analysis is: "R" is no proper name, and, that "R" stands between "a" and "b" expresses a *relation*. Here are two propositions *of different type* connected by "and".

Page 110

It is *obvious* that, e.g., with a subject-predicate proposition, *if* it has any sense at all, you *see* the form, so soon as you *understand* the proposition, in spite of not knowing whether it is true or false. Even if there *were* propositions of [the] form "M is a thing" they would be superfluous (tautologous) because what this tries to say is something which is already *seen* when you see "M".

Page 110

In the above expression "aRb", we were talking only of this particular "R", whereas what we want to do is to talk of all similar symbols. We have to say: in *any* symbol of this form what corresponds to "R" is not a proper name, and [the] fact that ["R" stands between "a" and "b"] expresses a relation. This is what is sought to be expressed by the nonsensical assertion: Symbols like this are of a certain type. This you can't say, because in order to say it you must first know what the symbol is: and in knowing this you *see* the type and therefore also [the] type of [what is] symbolized. I.e. in knowing *what* symbolizes, you know all that is to be known; you can't *say* anything *about* the symbol.

Page 110

For instance: Consider the two propositions (1) "What symbolizes here is a thing", (2) "What symbolizes here is a relational fact = relation". These are nonsensical for two reasons: (a) because they mention "thing" and "relation"; (b) because they mention them in propositions of the same form. The two propositions must be expressed in entirely different forms, if properly analysed; and neither the word "thing" nor "relation" must occur.

Page 110

Now we shall see how properly to analyse propositions in which "thing", "relation", etc., occur.

Page 110

(1) Take ϕx . We want to explain the meaning of 'In " ϕx " a *thing* symbolizes'. The analysis is:--

Page 110

$(\exists y)$. y symbolizes. y = "x". " ϕx "

Page 110

["x" is the name of y: " ϕx " = " ϕ " is at [the] left of "x" and *says* ϕx .]

Page 110

N.B. "x" can't be the name of this actual scratch y, because this isn't a thing: but it can be the name of a *thing*; and we must understand that what we are doing is to explain what would be meant by saying of an ideal symbol, which did actually consist in one *thing's* being to the left of another, that in it a *thing* symbolized.

Page Break 111

Page 111

[N.B. In [the] expression $(\exists y).\phi y$, one is apt to say this means "There is a *thing* such that... ". But in fact we should say "There is a y, such that... "; the fact that the y symbolizes expressing what we mean.]

In general: When such propositions are analysed, while the words "thing", "fact", etc. will disappear, there will appear instead of them a new symbol, of the same form as the one of which we are speaking; and hence it will be at once obvious that we *cannot* get the one kind of proposition from the other by substitution.

In our language names are *not things*: we don't know what they are: all we know is that they are of a different type from relations, etc. etc.. The type of a symbol of a relation is partly fixed by [the] type of [a] symbol of [a] thing, since a symbol of [the] latter type must occur in it.

N.B. In any ordinary proposition, e.g., "Moore good", this *shews* and does not say that "*Moore*" is to the left of "good"; and *here what* is shewn can be *said* by another proposition. But this only applies to that *part* of what is shewn which is arbitrary. The *logical* properties which it shews are not arbitrary, and that it has these cannot be said in any proposition.

When we say of a proposition of [the] form "aRb" that what symbolizes is that "R" is between "a" and "b", it must be remembered that in fact the proposition is capable of further analysis because a, R, and b are not *simples*. But what seems certain is that when we have analysed it we shall in the end come to propositions of the same form in respect of the fact that they do consist in one thing being between two others.†1

How can we talk of the general form of a proposition, without knowing any unanalysable propositions in which particular names and relations occur? What justifies us in doing this is that though we don't know any unanalysable propositions of this kind, yet we can understand what is meant by a proposition of the form $(\exists x, y, R).xRy$ (which is unanalysable), even though we know no proposition of the form xRy .

If you had any unanalysable proposition in which particular names and relations occurred (and *unanalysable* proposition = one in which only fundamental symbols = ones not capable of *definition*, occur) then you always can form from it a proposition of the form $(\exists x, y, R).xRy$, which though it contains no particular names and relations, is unanalysable.

(2) The point can here be brought out as follows. Take ϕa and ϕA :

and ask what is meant by saying, "There is a thing in ϕa , and a complex in ϕA "?

(1) means: $(\exists x).\phi x.x = a$

(2) $(\exists x, \psi \xi).\phi A = \psi x.\phi x.\dagger 1$

Use of logical propositions. You may have one so complicated that you cannot, by looking at it, see that it is a tautology; but you have shewn that it can be derived by certain operations from certain other propositions according to our rule for constructing tautologies; and hence you are enabled to see that one thing follows from another, when you would not have been able to see it otherwise. E.g., if our tautology is of [the] form $p \supset q$ you can see that q follows from p ; and so on.

The *Bedeutung* of a proposition is the fact that corresponds to it, e.g., if our proposition be "aRb", if it's true, the corresponding fact would be the fact aRb, if false, the fact $\sim aRb$. *But* both "the fact aRb" and "the fact $\sim aRb$ " are incomplete symbols, which must be analysed.

That a proposition has a relation (in wide sense) to Reality, other than that of *Bedeutung*, is shewn by the fact that you can understand it when you don't know the *Bedeutung*, i.e. don't know whether it is true or false. Let us express this by saying "It has *sense*" (*Sinn*).

In analysing *Bedeutung*, you come upon *Sinn* as follows:

We want to explain the relation of propositions to reality.

The relation is as follows: Its *simples* have meaning = are names of simples; and its relations have a quite

different relation to relations; and these two facts already establish a sort of correspondence between a proposition which contains these and only these, and reality: i.e. if all the simples of a proposition are known, we already know that we CAN describe reality by saying that it *behaves*†2 in a certain way to the whole proposition. (This amounts to saying that we can *compare* reality with the proposition. In the case of two lines we can *compare* them in respect of their length without any convention: the comparison is automatic. But in our case the possibility of comparison depends upon the conventions by which we have given meanings to our simples (names and relations).)

Page 112

It only remains to fix the method of comparison by saying *what* about our simples is to *say* what about reality. E.g., suppose we take two lines of unequal length; and say that the fact that the shorter is of the length it is is to mean that the longer is of the length *it* is. We should then have established a convention as to the meaning of the shorter, of the sort we are now to give.

Page Break 113

Page 113

From this it results that "true" and "false" are not accidental properties of a proposition, such that, when it has meaning, we can say it is also true or false: on the contrary, to have meaning *means* to be true or false: the being true or false actually constitutes the relation of the proposition to reality, which we mean by saying that it has meaning (*Sinn*).

Page 113

There seems at first sight to be a certain ambiguity in what is meant by saying that a proposition is "true", owing to the fact that it seems as if, in the case of different propositions, the way in which they correspond to the facts to which they correspond is quite different. But what is really common to all cases is that they must have *the general form of a proposition*. In giving the general form of a proposition you are explaining what kind of ways of putting together the symbols of things and relations will correspond to (be analogous to) the things having those relations in reality. In doing thus you are saying what is meant by saying that a proposition is true; and you must do it once for all. To say "This proposition *has sense*" means "'This proposition is true' means...." ("p" is true = "p". p. Def.: only instead of "p" we must here introduce the general form of a proposition.)†1

Page 113

It seems at first sight as if the ab notation must be wrong, because it seems to treat true and false as on exactly the same level. It must be possible to see from the symbols themselves that there is some essential difference between the poles, if the notation is to be right; and it seems as if in fact this was impossible.

Page 113

The interpretation of a symbolism must not depend upon giving a different interpretation to symbols of the same types.

Page 113

How asymmetry is introduced is by giving a description of a particular form of symbol which we call a "tautology". The description of the ab-symbol alone is symmetrical with respect to a and b; but this description plus the fact that what satisfies the description of a tautology *is* a tautology is asymmetrical with regard to them. (To say that a description was symmetrical with regard to two symbols, would mean that we could substitute one for the other, and yet the description remain the same, i.e. mean the same.)

Page 113

Take p.q and q. When you write p.q in the ab notation, it is impossible to see from the symbol alone that q follows from it, for if you were to interpret the true-pole as the false, the same symbol would stand for $p \vee q$, from which q doesn't follow. But the moment you

Page Break 114

say *which* symbols are tautologies, it at once becomes possible to see from the fact that they are and the original symbol that q does follow.

Page 114

Logical propositions, OF COURSE, all shew something different: all of them shew, *in the same way*, viz by the fact that they are tautologies, but they are different tautologies and therefore shew each something different.

Page 114

What is unarbitrary about our symbols is not them, nor the rules we give; but the fact that, having given certain rules, others are fixed = follow logically. [Cf. 3.342.]

Thus, though it would be possible to interpret the form which we take as the form of a tautology as that of a contradiction and vice versa, they *are* different in logical form because though the apparent form of the symbols is the same, what *symbolizes* in them is different, and hence what follows about the symbols from the one interpretation will be different from what follows from the other. But the difference between a and b is *not* one of logical form, so that nothing will follow from this difference alone as to the interpretation of other symbols. Thus, e.g., $p, q, p \vee q$ seem symbols of exactly the *same* logical form in the ab notation. Yet they say something entirely different; and, if you ask why, the answer seems to be: In the one case the scratch at the top has the shape b, in the other the shape a. Whereas the interpretation of a tautology as a tautology is an interpretation of a *logical form*, not the giving of a meaning to a scratch of a particular shape. The important thing is that the interpretation of the form of the symbolism must be fixed by giving an interpretation to its *logical properties*, *not* by giving interpretations to particular scratches.

Logical constants can't be made into variables: because in them *what* symbolizes is *not* the same; all symbols for which a variable can be substituted symbolize in the *same* way.

We describe a symbol, and say arbitrarily "A symbol of this description is a tautology". And then, it follows at once, both that any other symbol which answers to the same description is a tautology, and that any symbol which does *not* isn't. That is, we have arbitrarily fixed that any symbol of that description is to be a tautology; and this being fixed it is no longer arbitrary with regard to any other symbol whether it is a tautology or not.

Having thus fixed what is a tautology and what is not, we can then, having fixed arbitrarily again that the relation a-b is transitive get from the two facts together that " $p \equiv \sim(\sim p)$ " is a tautology. For $\sim(\sim p) = a-b-a-p-b-a-b$. The point is: that the process of reasoning by which we arrive at the result that a-b-a-p-b-a-b is the *same symbol* as a-p-b, is

exactly the same as that by which we discover that its meaning is the same, viz where we reason if b-a-p-b-a, then *not* a-p-b, if a-b-a-p-b-a-b then *not* b-a-p-b-a, therefore if a-b-a-p-b-a-b, then a-p-b.

It follows from the fact that a-b is transitive, that where we have a-b-a, the first a has to the second the same relation that it has to b. It is just as from the fact that a-true implies b-false, and b-false implies c-true, we get that a-true implies c-true. And we shall be able to see, having fixed the description of a tautology, that $p \equiv \sim(\sim p)$ is a tautology.

That, when a certain rule is given, a symbol is tautological *shews* a logical truth.

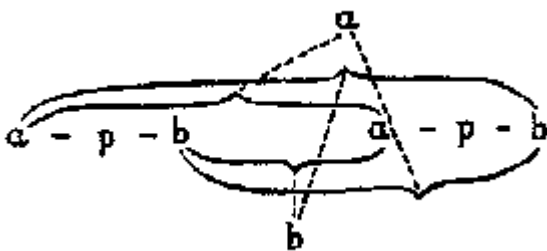

This symbol might be interpreted either as a tautology or a contradiction.

In settling that it is to be interpreted as a tautology and not as a contradiction, I am not assigning a *meaning* to a and b; i.e. saying that they symbolize different things but in the same way. What I am doing is to say that the way in which the a-pole is connected with the whole symbol symbolizes in a *different way* from that in which it would symbolize if the symbol were interpreted as a contradiction. And I add the scratches a and b merely in order to shew in which ways the connexion is symbolizing, so that it may be evident that wherever the same scratch occurs in the corresponding place in another symbol, there also the connexion is symbolizing in the same way.

We could, of course, symbolize any ab-function without using two *outside* poles at all, merely, e.g., omitting the b-pole; and here what would symbolize would be that the three pairs of inside poles of the propositions were connected in a certain way with the a-pole, while the other pair was *not* connected with it. And thus the difference

between the scratches a and b, where we do use them, merely shews that it is a different state of things that is symbolizing in the one case and the other: in the one case that certain inside poles *are* connected in a certain way with an outside pole, in the other *that* they're *not*.

Page Break 116

Page 116

The symbol for a tautology, in whatever form we put it, e.g., whether by omitting the a-pole or by omitting the b, would always be capable of being used as the symbol for a contradiction; only *not* in the same language.

Page 116

The reason why $\sim x$ is meaningless, is simply that we have given no meaning to the symbol $\sim \xi$. I.e. whereas ϕx and ϕp look as if they were of the same type, they are not so because in order to give a meaning to $\sim x$ you would have to have some *property* $\sim \xi$. What symbolizes in $\phi \xi$ is *that* ϕ stands to the left of a proper name and obviously this is not so in $\sim p$. What is common to all propositions in which the name of a property (to speak loosely) occurs is that this name stands to the left of a *name-form*.

Page 116

The reason why, e.g., it seems as if "Plato Socrates" might have a meaning, while "Abracadabra Socrates" will never be suspected to have one, is because we know that "Plato" has one, and do not observe that in order that the whole phrase should have one, what is necessary is *not* that "Plato" should have one, but that the fact *that* "Plato" is to the left of a name should.

Page 116

The reason why "The property of not being green is not green" is *nonsense*, is because we have only given meaning to the fact that "green" stands to the right of a name; and "the property of not being green" is obviously not *that*.

Page 116

ϕ cannot possibly stand to the left of (or in any other relation to) the symbol of a property. For the symbol of a property, e.g., ψx is *that* ψ stands to the left of a name form, and another symbol ϕ cannot possibly stand to the left of such a *fact*: if it could, we should have an illogical language, which is impossible.

p is false = $\sim(p$ is true) Def.

Page 116

It is very important that the apparent logical relations \vee , \supset , etc. need brackets, dots, etc., i.e. have "ranges"; which by itself shews they are not relations. This fact has been overlooked, because it is so universal--the very thing which makes it so important. [Cf. 5.461.]

Page 116

There are *internal* relations between one proposition and another; but a proposition cannot have to another *the* internal relation which a *name* has to the proposition of which it is a constituent, and which ought to be meant by saying it "occurs" in it. In this sense one proposition can't "occur" in another.

Page 116

Internal relations are relations between types, which can't be expressed in propositions, but are all shewn in the symbols themselves, and can be exhibited systematically in tautologies. Why we come to

Page Break 117

call them "relations" is because logical propositions have an analogous relation to them, to that which properly relational propositions have to relations.

Page 117

Propositions can have many different internal relations to one another. *The* one which entitles us to deduce one from another is that if, say, they are ϕa and $\phi a \supset \psi a$, then $\phi a. \phi a \supset \psi a \supset \psi a$ is a tautology.

Page 117

The symbol of identity expresses the internal relation between a function and its argument: i.e. $\phi a = (\exists x). \phi x. x = a$.

Page 117

The proposition $(\exists x). \phi x. x = a \equiv \phi a$ can be seen to be a tautology, if one expresses the *conditions* of the truth of $(\exists x). \phi x. x = a$, successively, e.g., by saying: This is true *if* so and so; and this again is true *if* so and so, etc., for $(\exists x). \phi x. x = a$; and then also for ϕa . To express the matter in this way is itself a cumbrous notation, of which the *ab*-notation is a neater translation.

Page 117

What symbolizes in a symbol, is that which is common to all the symbols which could in accordance with

the rules of logic = syntactical rules for manipulation of symbols, be substituted for it. [Cf. 3.344.]

Page 117

The question whether a proposition has sense (*Sinn*) can never depend on the *truth* of another proposition about a constituent of the first. E.g., the question whether $(x) x = x$ has meaning (*Sinn*) can't depend on the question whether $(\exists x) x = x$ is *true*. It doesn't describe reality at all, and deals therefore solely with symbols; and it says that they must *symbolize*, but not *what* they symbolize.

Page 117

It's obvious that the dots and brackets are symbols, and obvious that they haven't any *independent* meaning. You must, therefore, in order to introduce so-called "logical constants" properly, introduce the general notion of *all possible* combinations of them = the general form of a proposition. You thus introduce both ab-functions, identity, and universality (the three fundamental constants) simultaneously.

Page 117

The *variable proposition* $p \supset p$ is not identical with the *variable proposition* $\sim(p.\sim p)$. The corresponding universals *would* be identical. The variable proposition $\sim(p.\sim p)$ shews that out of $\sim(p.q)$ you get a tautology by substituting $\sim p$ for q , whereas the other does not shew this.

Page 117

It's very important to realize that when you have two different relations $(a,b)_R, (c,d)_S$ this does *not* establish a correlation between a and c , and b and d , or a and d , and b and c : there is no correlation whatsoever thus established. Of course, in the case of two pairs of terms united by the *same* relation, there is a correlation. This shews that the theory which held that a relational fact contained the terms and

Page Break 118

relations united by a *copula* (ϵ_2 is untrue; for if this were so there would be a correspondence between the terms of different relations.

Page 118

The question arises how can one proposition (or function) occur in another proposition? The proposition or function itself can't possibly stand in relation to the other symbols. For this reason we must introduce functions as well as names at once in our general form of a proposition; explaining what is meant, by assigning meaning to the fact that the names stand between the $|, \dagger 1$ and that the function stands on the left of the names.

Page 118

It is true, in a sense, that logical propositions are "postulates"--something which we "demand"; for we *demand* a satisfactory notation. [Cf. 6.1223.]

Page 118

A tautology (*not* a logical proposition) is not nonsense in the same sense in which, e.g., a proposition in which words which have no meaning occur is nonsense. What happens in it is that all its simple parts have meaning, but it is such that the connexions between these paralyse or destroy one another, so that they are all connected only in some irrelevant manner.

Page 118

Logical functions all presuppose one another. Just as we can see $\sim p$ has no sense, if p has none; so we can also say p has none if $\sim p$ has none. The case is quite different with ϕa , and a ; since here a has a meaning independently of ϕa , though ϕa presupposes it.

Page 118

The logical constants seem to be complex-symbols, but on the other hand, they can be interchanged with one another. They are not therefore really complex; what symbolizes is simply the general way in which they are combined.

Page 118

The combination of symbols in a tautology cannot possibly correspond to any one particular combination of their meanings--it corresponds to every possible combination; and *therefore what* symbolizes can't be the connexion of the symbols.

Page 118

From the fact that I *see* that one spot is to the left of another, or that one colour is darker than another, it seems to follow that it *is* so; and if so, this can only be if there is an *internal* relation between the two; and we might express this by saying that the *form* of the latter is part of the *form* of the former. We might thus give a sense to the assertion that logical laws are *forms* of thought and space and time *forms* of intuition.

Different logical types can have nothing whatever in common. But the mere fact that we can talk of the possibility of a relation of n places, or of an analogy between one with two places and one with four, shews that relations with different numbers of places have something in common, that therefore the difference is not one of type, but like the difference between different names--something which depends on experience. This answers the question how we can know that we have really got the most general form of a proposition. We have only to introduce what is *common* to all relations of whatever number of places.

The relation of "I believe p " to " p " can be compared to the relation of " p " says (besagt) p to p : it is just as impossible that I should be a simple as that " p " should be. [Cf. 5.542.]

APPENDIX III

EXTRACTS FROM WITTGENSTEIN'S LETTERS TO RUSSELL, 1912-20

Cambridge, 22.6.12.

... Logic is still in the melting pot but one thing gets more and more obvious to me: The propositions of Logic contain ONLY *apparent* variables and whatever may turn out to be the proper explanation of apparent variables, its consequences *must* be that there are NO *logical* constants.

Logic must turn out to be a *totally* different kind than any other science.

1.7.12.

... Will you think that I have gone mad if I make the following suggestion?: The sign " $(x).\phi x$ " is not a complete symbol but has meaning only in an inference of the kind: from $\vdash \phi x \supset_x \psi x$ follows ψa . Or more general: from $\vdash (x).\phi x.\epsilon_0(a)$ follows $\phi(a)$. I am--of course--most uncertain about the matter but something of the sort might really be true.

Hochreit, Post Hohenberg, Nieder-Österreich. (Summer, 1912.)

... What troubles me most at present, is not the apparent-variable-business, but rather the meaning of " \vee " " \supset " etc. This latter problem is--I think--still more fundamental and, if possible, still less recognized as a problem. If " $p \vee q$ " means a complex at all--which is quite doubtful--then, as far as I can see, one must treat " \vee " as *part* of a copula in the way we have talked over before. I have--I believe--tried all possible ways of solution *under that hypothesis* and found that if any one will do it *must* be something like this:

Let us write the proposition "from $\vdash p$ and $\vdash q$ follows $\vdash r$ " that way: " $i(p; q; r)$ ". Here " i " is a copula (we may call it inference) which copulates *complexes*.

Then " $\vdash (\epsilon_1(x,y).\vee.\epsilon_1(u,z))$ " is to mean:

$$\begin{aligned} & \vdash (\epsilon_1(x,y), \epsilon_1(z,u), \beta(x,y,z,u)).i[\epsilon_1(x,y); \epsilon_1(z,u); \beta(x,y,z,u)] \\ & \vdash (\epsilon_1(x,y), \epsilon_1(z,u), \beta(x,y,z,u)).i[\sim\epsilon_1(x,y); \epsilon_1(z,u); \beta(x,y,z,u)] \\ & \vdash (\epsilon_1(x,y), \epsilon_1(z,u), \beta(x,y,z,u)).i[\epsilon_1(x,y); \sim\epsilon_1(z,u); \beta(x,y,z,u)] \\ & \vdash (\epsilon_1(x,y), \epsilon_1(z,u), \beta(x,y,z,u)).i[\sim\epsilon_1(x,y); \sim\epsilon_1(z,u); \beta(x,y,z,u)] \\ & \vdash (x,y,z,u) \end{aligned}$$

If " $p \vee q$ " does not mean a complex, then heaven knows what it means!!

August, 1912.

... Now as to 'p∨q' etc: I have thought that possibility--namely that all our troubles could be overcome by assuming different sorts of Relations of signs to things--over and over and over again! for the last eight weeks!!! But I have come to the conclusion that this assumption does *not* help us a bit. In fact if you work out any such theory--I believe you will see that *it does not even touch our problem*. I have lately seen a new way out (or perhaps not out) of the difficulty. It is too long to be explained here, but I tell you so much, that it is based on new forms of propositions. For instance: $\sim|\sim (p,q)$, which is to mean 'the complex p has the opposite form of q's form'. That means that $\sim|\sim (p,q)$ holds for instance when p is $\epsilon_1 (a,b)$ and q is $\sim\epsilon_1 (c,d)$. Another instance of the new forms is $\forall (p,q,r)$ which means something like: "The form of the complex r is composed of the forms of p and q in the way 'or'". That means that $\forall (p,q,r)$ holds for instance when p is $\epsilon_1 (a,b)$, q is $\epsilon_1 (c,d)$ and r is $\epsilon_1 (e,f) \vee \epsilon_1 (g,h)$ etc. etc. The rest I leave to your imagination.

1912.

Page 121

I believe that our problems can be traced down to the *atomic* propositions. This you will see if you try to explain precisely in what way the Copula in such a proposition has meaning.

Page 121

I cannot explain it and I think that as soon as an exact answer to this question is given the problem of " \vee " and of the apparent variable will be brought *very* near to their solution if not solved. I now think about "Socrates is human" (Good old Socrates!).

IV Alleegasse 16. Wien. 26.12.12.

Page 121

... I had a long discussion with Frege about our theory of symbolism of which, I think, he roughly understood the general outline. He said he would think the matter over. The complex-problem is now clearer to me and I hope very much that I may solve it.

IV Alleegasse 16. Jan. 1913.

Page 121

... I have changed my views on "atomic" complexes: I now think that qualities, relations (like love) etc. are all copulae! That means I for instance analyse a subject-predicate proposition, say, "Socrates is

Page Break 122

human" into "Socrates" and "something is human", (which I think is not complex). The reason for this is a very fundamental one: I think that there cannot be different Types of things! In other words whatever can be symbolized by a simple proper name must belong to one type. And further: every theory of types must be rendered superfluous by a proper theory of symbolism: For instance if I analyse the proposition Socrates is mortal into Socrates, mortality and $(\exists x,y) \epsilon_1 (x,y)$ I want a theory of types to tell me that "mortality is Socrates" is nonsensical, because if I treat "mortality" as a proper name (as I did) there is nothing to prevent me to make the substitution the wrong way round. *But* if I analyse (as I do now) into Socrates and $(\exists x).x$ is mortal or generally into x and $(\exists x)\phi x$ it becomes impossible to substitute the wrong way round because the two symbols are now of a different *kind* themselves. What I am *most* certain of is not however the correctness of my present way of analysis, but of the fact that all theory of types must be done away with by a theory of symbolism showing that what seem to be *different kinds of things* are symbolized by different kinds of symbols which *cannot* possibly be substituted in one another's places. I hope I have made this fairly clear!

Page 122

Propositions which I formerly wrote $\epsilon_2 (a,R,b)$ I now write $R(a,b)$ and analyse them into a,b and

$(\exists x,y) R(x,y)$
not complex

June, 1913.

Page 122

... I can now express my objection to your theory of judgement exactly: I believe it is obvious that, from the proposition "A judges that (say) a is in a relation R to b", if correctly analysed, the proposition "a R b.∨.~a R b" must follow directly *without the use of any other premiss*. This condition is not fulfilled by your theory.

Hochreit, Post Hohenberg, Nieder-Österreich, 22.7.13.

Page 122

... My work goes on well; every day my problems get clearer now and I feel rather hopeful. All my progress comes out of the idea that the *indefinables* of Logic are of the general kind (in the same way as the so-called *definitions* of Logic are general) and this again comes from the abolition of the real variable.

Page 122

... I am very sorry to hear that my objection to your theory of judgment paralyses you. I think it can only be removed by a correct theory of propositions.

Page Break 123

Hochreit, Post Hohenberg, N.-Ö.

Page 123

(This letter seems to have been written sometime near to that of the letter dated 22.7.13.)

Page 123

Your axiom of reducibility is

$$\vdash :(\exists f):[f]x \equiv_x f!x;$$

now is this not all nonsense as this proposition has only then a meaning if we can turn the ϕ into an *apparent* variable. For if we cannot do so no general laws can ever follow from your axiom. The whole axiom seems to me at present a mere juggling trick. Do let me know if there is more in it. The axiom as you have put it is only a schema and the real Pp ought to be

$$\vdash :.(\phi):(\exists f):\phi(x) \equiv_x f!x,$$

and where would be the use of that?--

5.9.13.

Page 123

I am sitting here in a little place inside a beautiful fiord and thinking about the beastly theory of types. There are still some *very* difficult problems (and very fundamental ones too) to be solved and I won't begin to write until I have got some sort of a solution for them. However I don't think that will in any way affect the bipolarity business which still seems to me to be absolutely untangible.

c/o Draegni, Skjolden, Sogn, Norway. 29.10.13.

Page 123

... Identity is the very Devil and *immensely important*; *very* much more so than I thought. It hangs--like everything else--directly together with the most fundamental questions, especially with the questions concerning the occurrence of the *same* argument in different places of a function. I have all sorts of ideas for a solution of the problem but could not yet arrive at anything definite. However, I don't lose courage and go on thinking.

30.10.

Page 123

I wrote this†1 letter yesterday. Since then quite new ideas have come into my mind; new problems have arisen in the theory of molecular propositions and the theory of inference has received a new and very important aspect. One of the consequences of my new ideas will--I think--be that the whole of Logic follows from one Pp only!! I cannot say more about it at present.

Page Break 124

1913.

Page 124

Thanks for your letter and the typed stuff!†1 I will begin by answering your questions as well as I can:

Page 124

(1) Your question was--I think due to the misprint (polarity instead of *bi*-polarity). What I mean to say is that we *only* then understand a proposition if we know *both* what would be the case if it was *false and* what if it was *true*.

Page 124

(2) The symbol for $\sim p$ is a-b-p-a-b. The proposition p has two poles and it does not matter a hang where they stand. You might just as well write $\sim p$ like this

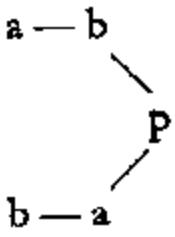

or $b-a-p-b-a$ etc. etc. All that *is* important is that the new a -pole should be correlated to the old b -pole and vice versa *wherever these old poles may stand*. If you had only remembered the WF scheme of $\sim p$ you would never have asked this question (I think). In fact all rules of the ab symbolism follow directly from the essence of the WF scheme.

Page 124

(3) Whether ab -functions and your truth-functions are the same cannot yet be decided.

Page 124

(4) "The correlation of new poles is to be transitive" means that by correlating one pole in the symbolizing way to another and the other to a third we have *thereby* correlated the first in the symbolizing way to the third, etc.. For instance in $a-b-a-b-a-b-a-b$, a and b are correlated to b and a respectively and this means that our symbol is the same as $a-b-a-b$.

Page 124

(5) $(p) p \vee \sim p$ is derived from *the function* $p \vee \sim q$ but the point will only become quite clear when identity is clear (as you said). I will some other time write to you about this matter at length.

Page 124

(6) Explanation in the typed stuff.

Page 124

(7) You say, you thought that *Bedeutung* was the "fact", this is quite true, but remember that there are no such things as facts and that therefore this proposition itself wants analysing. If we speak of "die *Bedeutung*" we seem to be speaking of a thing with a proper name. Of course the symbol for "a fact" is a proposition and this is *no* incomplete symbol.

Page Break 125

Page 125

(8) The exact $a-b$ indefinable is given in the manuscript.

Page 125

(9) An account of general indefinables? Oh Lord! It is too boring!!! Some other time!--Honestly--I *will* write to you about it some time, if by that time you have not found out all about it (because it is all quite clear in the manuscript I think). But just now I am *so* troubled with Identity that I really cannot write any long jaw. All sorts of new logical stuff seems to be growing in me, but I can't yet write about it.

Page 125

... The following is a list of the questions you asked me in your letter of the 25th.10.:

Page 125

(1) "What is the point of ' $p \equiv$. "p" is true'? I mean why is it worth saying?"

Page 125

(2) "If ' apb ' is the symbol for p , is ' bpa ' the symbol for $\sim p$? and if not, what is?"

Page 125

(3) "What you call ab -functions are what the Principia calls 'truth-functions'. I don't see why you shouldn't stick to the name 'truth-functions'."

Page 125

(4) "I don't understand your rules about a 's and b 's, i.e. 'the correlation of new poles is to be transitive'."

Page 125

(5) (Is obvious from my letter) so is (6).

Page 125

(7) "You say 'Weder der Sinn noch die Bedeutung eines Satzes ist ein Ding. Jene Worte sind unvollständige Zeichen". I understand neither being a *thing*, but I thought the *Bedeutung* was the *fact*, which is surely not indicated by an incomplete symbol?"

Page 125

I don't know whether I have answered the question (7) clearly. The answer is *of course* this: The *Bedeutung* of a proposition is symbolized by the proposition--which is *of course* not an incomplete symbol, *but the word*

"Bedeutung" is an incomplete symbol.

Page 125

(8) and (9) are obvious.

Nov., 1913.

Page 125

... I beg you to notice that, although I shall make use in what follows of my ab notation, the meaning of this notation is not needed; that is to say, even if this notation should turn out not to be the final correct notation what I am going to say is valid if you only admit--as I believe you must do--that it is a *possible* notation. Now listen! I will first talk about those logical propositions which are or might be contained in the first 8 chapters of Principia Mathematica. That they all follow from *one* proposition is clear because *one symbolic* rule is

Page Break 126

sufficient to recognize each of them as true or false. And this is the *one* symbolic rule: write the proposition down in the ab notation, trace all connections (of poles) from the outside to the inside poles: Then if the b-pole is connected to such *groups of inside poles only as contain opposite poles of one proposition*, then the whole proposition is a true, logical proposition. If on the other hand this is the case with the a-pole the proposition is false and logical. If finally neither is the case the proposition may be true or false, but it is in no case logical. Such for instance $(p) \sim p$ transmuted to a suitable type, of course--is not a logical proposition at all and its truth can neither be proved nor disproved from logical propositions alone. The same is the case--by the way--with your axiom of reducibility, *it is not a logical proposition at all* and the same applies to the axioms of infinity and the multiplicative axiom. *If these are true propositions they are what I shall call "accidentally" true and not "essentially" true.* Whether a proposition is accidentally or essentially true can be seen by writing it down in the ab notation and applying the above rule. What I--in stating this rule--called "logical" proposition is a proposition which is either essentially true or essentially false. This distinction of accidentally and essentially true propositions explains--by the way--the feeling one always had about the infinity axiom and the axiom of reducibility, the feeling that if they were true they would be so by a lucky accident.

Page 126

Of course the rule I have given applies first of all only for what you called elementary propositions. But it is easy to see that it must also apply to all others. For consider your two Pps in the theory of apparent variables *9.1 and *9.11. Put then instead of $\phi x, (\exists y). \phi y. y = x$ and it becomes obvious that the special cases of these two Pps like those of all the previous ones become tautologous if you apply the ab notation. The ab Notation for Identity is not yet clear enough to show this clearly but it is obvious that such a Notation can be made up. I can sum up by saying that a logical proposition is one the special cases of which are either tautologous--and then the proposition is true--or self-contradictory (as I shall call it) and then it is false. And the ab notation simply shows directly which of these two it is (if any).

Page 126

That means that there is *one* method of proving or disproving all logical propositions and this is: writing them down in the ab notation and looking at the connections and applying the above rule. But if *one* symbolic rule will do, there must also be *one* Pp that will do. There is much that follows from all this and much that I could only explain vaguely but if you really think it over you will find that I am right.

Page Break 127

Norway, 1913.

Page 127

... Ich will dasjenige, was ich in meinem letzten Brief über Logik schrieb, noch einmal in anderer Weise wiederholen: Alle Sätze der Logik sind Verallgemeinerungen von Tautologien and alle Verallgemeinerungen von Tautologien sind Sätze der Logik. Andere logische Sätze gibt es nicht. (Dies halte ich für definitiv). Ein Satz wie " $(\exists x). x = x$ " zum Beispiel ist eigentlich ein Satz der Physik. Der Satz " $(x): x = x. \supset. (\exists y). y = y$ " ist ein Satz der Logik; es ist nun Sache der Physik zu sagen, *ob es ein Ding gibt*. Dasselbe gilt vom infinity axiom; ob es \dot{A}_0 Dinge gibt, das zu bestimmen ist Sache der Erfahrung (und die kann es nicht entscheiden). Nun aber zu Deinem Reductions-Axiom: Stell' Dir vor, wir leben in einer Welt, worin es nichts als *Dinge* gäbe and außerdem *nur noch eine Relation*, welche zwischen unendlich vielen dieser Dinge bestehe and zwar so, daß sie nicht zwischen jedem Ding and jedem anderen besteht, and daß sie ferner auch nie zwischen einer endlichen Anzahl von Dingen besteht. Es ist klar, daß das axiom of reducibility in einer solchen Welt sicher *nicht* bestünde. Es ist mir aber auch klar, daß es nicht die Sache der Logik ist darüber zu entscheiden, ob die Welt worin wir leben nun wirklich so ist, oder nicht. Was aber Tautologien eigentlich sind, das kann ich selber noch nicht ganz klar sagen, will aber trachten es ungefähr zu erklären. Es ist das

eigentümliche (und *höchst* wichtige) Merkmal der *nicht*-logischen Sätze, daß man ihre Wahrheit *nicht* am Satzzeichen selbst erkennen kann. Wenn ich z. B. sage "Meier ist dumm", so kannst Du dadurch, daß Du diesen Satz anschaust, nicht sagen ob er wahr oder falsch ist. Die Sätze der Logik aber--und sie allein--haben die Eigenschaft, daß sich ihre Wahrheit bzw. Falschheit schon in ihrem Zeichen ausdrückt. Es ist mir noch nicht gelungen, für die Identität eine Bezeichnung zu finden, die dieser Bedingung genügt; aber *ich zweifle nicht*, daß sich eine solche Bezeichnungsweise finden lassen muß. Für zusammengesetzte Sätze (elementary propositions) genügt die ab-Bezeichnungsweise. Es ist mir unangenehm, daß Du die Zeichenregel an meinem letzten Brief nicht verstanden hast, denn es langweilt mich *unsagbar* sie zu erklären!! Du könntest sie auch durch ein bißchen Nachdenken selber finden!

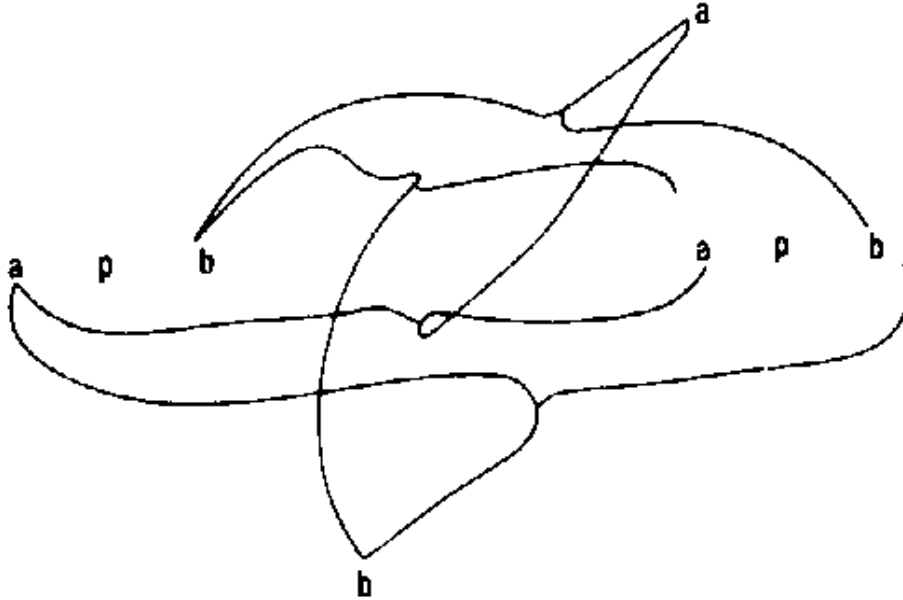

Dies ist das Zeichen für $p \equiv p$; es ist tautologisch weil *b* nur mit solchen Polpaaren verbunden ist, welche aus den entgegengesetzten Polen eines Satzes (nämlich *p*) bestehen; wenn Du dies auf Sätze anwendest, die mehr als 2 Argumente haben so erhält Du die allgemeine Regel,

Page Break 128

wonach Tautologien gebildet werden. Ich bitte Dich denke selbst über die Sache nach, es ist mir *schrecklich* eine schriftliche Erklärung zu wiederholen, die ich schon zum ersten Mal mit dem allergrößten *Widerstreben* gegeben habe. Die Identität ist mir--wie gesagt--noch gar nicht klar. Also hierüber ein andermal! Wenn Dein Axiom of Reducibility fällt, so wird manches geändert werden müssen. Warum gebrauchst Du als Definition der Klassen nicht diese:

$$F[\hat{X}(\phi x)] =: \phi z \equiv z \psi x. \supset \psi. F(\psi) \text{ Def. } ?$$

... Die große Frage ist jetzt: Wie muß ein Zeichensystem beschaffen sein, damit es jede Tautologie *auf eine and dieselbe Weise* als Tautologie erkennen läßt? Dies ist das Grundproblem der Logik!

Page 128

... Ich will nur noch sagen, daß Deine Theorie der "Descriptions" *ganz zweifellos* richtig ist, selbst wenn die einzelnen Urzeichen darin ganz andere sind als Du glaubst.

Page 128

Translation of the above:

I want to repeat what I wrote about logic in my last letter, putting it in a different way: All propositions of logic are generalizations of tautologies and all generalizations of tautologies are propositions of logic. There are no logical propositions but these. (I consider this to be definitive.) A proposition like " $(\exists x)x = x$ " is for example really a proposition of physics. The proposition " $(x):x = x. \supset. (\exists y).y = y$ " is a proposition of logic: it is for physics to say *whether any thing exists*. The same holds of the infinity axiom; whether there are \hat{A}_0 things is for experience to settle (and experience can't decide it). But now for your reducibility axiom: Imagine our living in a world, where there is nothing but *things*, and besides *only one relation*, which holds between infinitely many of these things, but does not hold between every one and every other of them: further, it never holds between a finite number of things. It is clear that the axiom of reducibility would certainly *not* hold in such a world. But it is also clear to me that it is not for logic to decide whether the world we live in is actually like this or not. However, I can't myself say quite clearly yet what tautologies really are, but I'll try to give a rough account. It is the peculiar (and most important) characteristic of *non*-logical propositions, that their truth cannot be seen in the propositional sign itself. If I say for

example 'Meier is stupid', you cannot tell whether this proposition is true or false by looking at it. But the propositions of logic--and they alone--have the property of expressing their truth or falsehood in the very sign itself. I haven't yet succeeded in getting a notation for identity which satisfies this condition; but I *don't doubt* that such a

Page Break 129

notation must be discoverable. For compounded propositions (elementary propositions) the ab notation is adequate. I am upset that you did not understand the rule for the signs in my last letter, since it bores me *unspeakably* to explain it! You could get at it for yourself if you would think a bit!

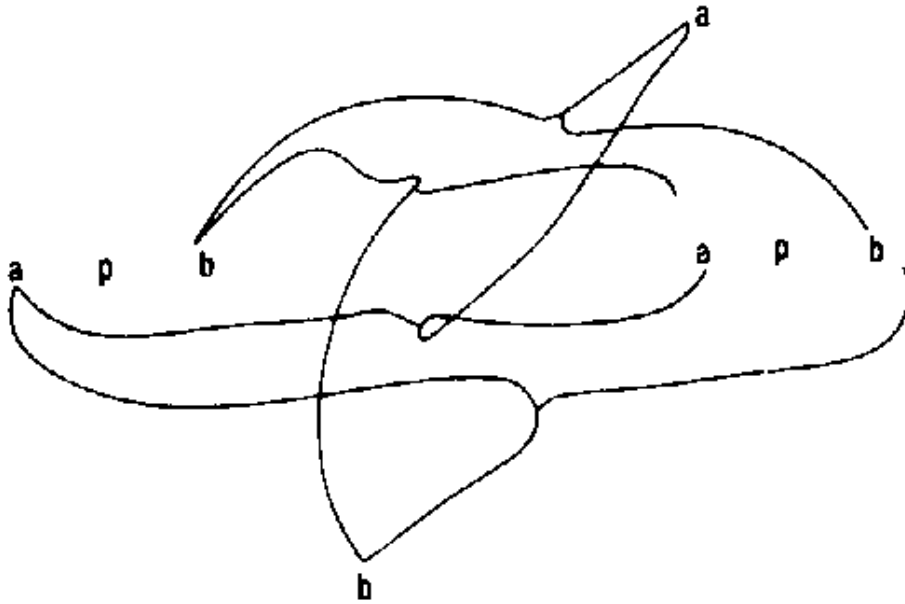

This is the sign for $p \equiv p$; it is tautological because b is connected only with such pairs of poles as consist of opposed poles of a proposition (p); if you apply this to propositions with more than 2 arguments, you get the general rule according to which tautologies are constructed. Please think the matter over yourself, I find it *awful* to repeat a written explanation, which I gave the first time with the *greatest reluctance*. So, another time! If your Axiom of Reducibility fails, various things will have to be altered. Why don't you use the following as a definition of classes:

$$F[\hat{X}(\phi x)] =: \phi z \equiv z \psi x. \supset \psi. F(\psi) \text{ Def. ?}$$

... The great question is now: How should a notation be constructed, which will make every tautology recognizable as a tautology *in one and the same way*? This is the fundamental problem of logic.

Page 129

... The only other thing I want to say is that your Theory of Descriptions is *quite undoubtedly* right, even if the individual primitive signs in it are quite different from what you believe.

Skjolden, 15.12.13.

Page 129

... Die Frage nach dem Wesen der Identität läßt sich nicht beantworten, ehe das Wesen der Tautologies erklärt ist. Die Frage nach diesem aber ist die Grundfrage *aller* Logik.

Page 129

... The question of the nature of identity cannot be answered until the nature of tautologies is explained. But that question is the fundamental question of *all* logic.

Skjolden/Januar, 1914/.

Page 129

... Jetzt noch eine Frage: Sagt der "Satz vom zureichenden Grunde" (Law of causality) nicht einfach, daß Raum and Zeit relativ sind? Dies scheint mir jetzt ganz klar zu sein; denn alle die Ereignisse von denen dieser Satz behaupten soll, daß sie nicht eintreten können, könnten überhaupt nur in einer absoluten Zeit and einem absoluten

Page Break 130

Raum eintreten. (Dies wäre freilich noch kein unbedingter Grund zu meiner Behauptung.) Aber denke an den Fall des Massenteilchens, das, allein in der Welt existierend, and seit aller Ewigkeit in Ruhe, plötzlich im Zeitpunkt A anfängt sich zu bewegen; und denke an ähnliche Fälle, so wirst Du--glaube ich--sehen, daß *keine* Einsicht a priori uns solche Ereignisse als unmöglich erscheinen läßt, *außer eben in dem Fall*, da Raum and Zeit relativ sind. Bitte schreibe mir Deine Meinung in diesem Punkte.

... Now another question: Doesn't the "Principle of Sufficient Reason" (Law of Causality) simply say that space and time are relative? At present this seems to me to be quite clear; for all the events, whose occurrence this principle is supposed to exclude, could only occur at all in an absolute time and an absolute space. (This would not of course quite justify my assertion.) But think of the case of a particle, which was the only thing in the world and had been at rest from all eternity, and then suddenly begins to move at a moment of time A; and of similar cases: then you will see--or so I believe--that *no a priori* insight makes such events seem impossible to us, *except in the case* of space and time's being relative. Please write me your opinion on this point.

Cassino, 19.8.19.†1

(1) "What is the difference between *Tatsache* and *Sachverhalt*?" *Sachverhalt* is, what corresponds to an *Elementarsatz* if it is true. *Tatsache* is what corresponds to the logical product of elementary props when this product is true. The reason why I introduce *Tatsache* before introducing *Sachverhalt* would want a long explanation.

(2) "... But a *Gedanke* is a *Tatsache*: what are its constituents and components, and what is their relation to those of the pictured *Tatsache*?" I don't know *what* the constituents of a thought are but I know *that* it must have such constituents which correspond to the words of Language. Again the kind of relation of the constituents of the thought and of the pictured fact is irrelevant. It would be a matter of psychology to find out.

(3) "The theory of types, in my view, is a theory of correct symbolism: a simple symbol must not be used to express anything complex: more generally, a symbol must have the same structure as its meaning." That's exactly what one can't say. You cannot prescribe to a symbol

what it *may* be used to express. All that a symbol *can* express, it *may* express. This is a short answer but it is true!

(4) "Does a *Gedanke* consist of words?" No! But of psychical constituents that have the same sort of relation to reality as words. What those constituents are I don't know.

(5) "It is awkward to be unable to speak of $Nc^cV\ddagger 1$." This touches the cardinal question of what can be expressed by a prop, and what can't be expressed, but only shown. I can't explain it at length here. Just think that, what you want to *say* by the apparent proposition "There are 2 things" is *shown* by there being two names which have different meanings (or by there being one name which may have two meanings). A proposition e.g. $\phi(a,b)$ or $(\exists \phi, x, y). \phi(x, y)$ doesn't say that there are two things, it says something quite different; *but whether it's true or false, it shows* you what you want to *express* by saying: "there are 2 things".

(6) Of course no elementary props are negative.

(7) "It is necessary also to be given the proposition that all elementary propositions are given." This is not necessary because it is even impossible. There is no such proposition! That all elementary propositions are given is *shown* by there being none having an elementary sense which is not given. This is again the same story as in No. 5.

(8) I suppose you didn't understand the way how I separate in the old notation of generality what is in it truth-function and what is purely generality. A general proposition is a truth-function of *all propositions* of a certain form.

(9) You are quite right in saying that " $N(\xi)$ " may also be made to mean $\sim p \vee \sim q \vee \sim r \vee \dots$. But this doesn't matter! I suppose you don't understand the notation " ξ ". It does not mean "for all values of ξ ...". But all is said in my book about it and I feel unable to write it again.

9.4.20.

Besten Dank für Dein Manuskript.†2 Ich bin mit so manchem darin nicht ganz einverstanden; sowohl dort, wo Du mich kritisierst, als auch dort, wo Du bloß meine Ansicht klarlegen willst. Das macht aber nichts. Die Zukunft wird über uns urteilen. Oder auch nicht--und wenn sie schweigen wird, so wird das auch ein Urteil sein.

Many thanks for your manuscript. I am not quite in agreement with a lot of it: both where you criticize me, and where you are merely trying to expound my views. But it doesn't matter. The future will judge between us. Or it won't--and if it is silent, that will be a judgment too.

6.5.20.

... Nun wirst Du aber auf mich böse sein, wenn ich Dir etwas erzähle; Deine Einleitung wird nicht gedruckt and in folgedessen wahrscheinlich auch mein Buch nicht.--Als ich nämlich die deutsche Übersetzung der Einleitung vor mir hatte, da konnte ich mich doch nicht entschließen, sie mit meiner Arbeit drucken zu lassen. Die Feinheit Deines englischen Stils war nämlich in der Übersetzung--selbstverständlich--verloren gegangen and was übrig blieb, war Oberflächlichkeit and Mißverständnis. Ich schickte nun die Abhandlung and Deine Einleitung an Reclam und schrieb ihm, ich wünschte nicht, daß die Einleitung gedruckt würde, sondern sie solle ihm nur zur Orientierung über meine Arbeit dienen. Es ist nun höchst wahrscheinlich, daß Reclam meine Arbeit daraufhin nicht nimmt (obwohl ich noch keine Antwort von ihm habe).

... Now, however, you will be angry at what I have to tell you: your introduction will not be printed, and in consequence probably neither will my book. For when I got the German translation of the introduction, I couldn't bring myself to have it printed with my work after all. For the fineness of your English style was--of course--quite lost and what was left was superficiality and misunderstanding. Now I have sent the treatise and your introduction to Reclam, and have written to him that I did not want the introduction to be printed, but that he should just use it to orientate himself about my work. It is now extremely likely that in consequence Reclam will not take my work (although I have not had an answer from him yet).

APPENDIX IV†*

$$\exists x \exists y \phi(x, y) = (xRy) = xRy$$

~~Problem~~ $\phi(x) \equiv \psi(x) \rightarrow \phi \psi$
 von zwei Klassen. Zusammen die Menge
 abzudecken sagt etwas. Von zwei
 Mengen die ϕ sagen sagt nicht mehr
 das schon ist die Unzulänglich-
 keit der Russell'schen Beweismeth.
 6.9.14.

$$a \in Z(\psi x) \equiv \psi(a) \equiv \psi(a) \rightarrow a \in \psi$$

7.9.14

$$a \times b + b \times c = c \times d \cdot d \times e = \psi(a, e)$$

19.9.14

(x, y) $\psi(x, y)$
 wie kann man eine Funktion auf
 einer ganz beliebigen Menge immer
 stellen fragen!

$$\psi(a), \psi(b), a \times b, (\exists x) \psi(x): \psi x \cdot \psi y \cdot x \times y$$

$$a \times b \cdot \psi a \cdot \psi b \rightarrow (\psi, \psi)(a \times b) = \Omega(a)$$

23.9.14

* See Preface.

$$F(\psi(x)) = \psi \circ F \circ \psi^{-1}$$

$$\psi \circ F \circ \psi^{-1} = \psi \circ F \circ \psi^{-1} \circ \psi \circ \psi^{-1} = \psi \circ F \circ \psi^{-1} \circ \psi \circ \psi^{-1} = \psi \circ F \circ \psi^{-1}$$

$$F(\psi(x)) = \psi \circ F \circ \psi^{-1} \circ \psi \circ \psi^{-1} = \psi \circ F \circ \psi^{-1}$$

17.4.16.

$$\psi(x) \cdot \psi(y) = \psi(x \cdot y) = \psi(x) \cdot \psi(y)$$

$$F(x) \cdot F(y) = F(x \cdot y)$$

$$F(x \cdot y) = F(x) \cdot F(y) = \psi(x) \cdot \psi(y)$$

$$(\exists x) \cdot \psi(x) \quad \psi(z) = \psi(z) \circ \psi^{-1} \circ \psi \circ \psi^{-1} = \psi(z)$$

6.5.16

21.5.16

$$(\exists x) \cdot (\exists y) \cdot \psi(x) \cdot \psi(y) = \psi(x) \cdot \psi(y) = \psi(x \cdot y)$$

24.5.16

25.5.16

11.7.16

Es aber ist der wichtige Aus.
 druck für $(\exists x) \cdot \varphi(x)$

$$(\exists \alpha) [\varphi(\alpha) \mid \psi(\beta) \dots]$$

~~...~~

$$\varphi(x, y) \dots = \varphi_0(x, y, \dots)$$

$$(\exists x) \cdot \varphi_0(x, y, \dots) \quad , \quad (\exists y) : (\exists x) \cdot \varphi_0(x, y, \dots)$$

$$(\exists x) : (\exists \alpha) : (\exists \alpha) \cdot \varphi_0(\alpha, \alpha, \alpha, \dots)$$

$$(\exists \alpha) \{ \varphi_0(\alpha, \dots) \} \dots$$

16.7.16.

$$\begin{aligned} x R y & \quad \quad \quad \neg \neg \cdot \neg R \neg \\ x R y \wedge y R z & \quad \quad \quad \neg \neg R \neg \\ x R y \cdot y R z \cdot z R u & \quad \quad \quad \neg \neg R \neg (\neg \neg R \neg) \dots \end{aligned}$$

20.7.16.
 alle Entdeckung aller
 Satzformeln war im Grunde
 nicht mehr als eine andere
 Art der Allgemeinheit zu
 suchen war.

Setzt noch das Abwechseln
 zwischen (Rx) und (y) ausprüchen
 kann über die Allgemeines
 der Form wie in der Success
 Relation.

$Rx \cdot xRy \cdot yRz \dots nRb$
 $\cdot xRy \{ \exists aRx \} \dots$

15. 7. 16.

$(Rx \cdot xRy \dots zRb)$
 $(Rb \vee aRx \vee bRy \vee cRz \dots \vee nRb) \cdot xRy \cdot yRz$
 $\dots nRb$

hier kann man nicht sagen
 der Essenz der Dingen die kein
 ein da auch die Satz a R b nicht
 in Bedingungen entspricht.

Sicht: scheint einfacher zu sein
 als es ist wie, a ist ein Nächst
 ist!

FOOTNOTE

Page 7 †1 This remark refers to an incident, about which Wittgenstein later told several of his friends. (Cf. G. H. von Wright, Ludwig Wittgenstein, a Biographical Sketch in the Philosophical Review, Vol. LXIV, 1955, pp. 532-533.) To judge from the date of the present MS., however, this incident cannot very well have taken place in a trench on the East Front. (Edd.)

†1 Referring back.

Page 15

†1 I render 'Bedeutung', here and elsewhere, by 'reference' in order to bring it especially to the reader's attention, (a) that Wittgenstein was under the influence of Frege in his use of 'Sinn' ('sense') and 'Bedeutung' ('reference' or 'meaning' in the sense 'what a word or sentence *stands for*') and (b) that there is a great contrast between his idea at this stage of the *Notebooks* and those of the *Tractatus*, where he denies that logical constants or sentences have 'Bedeutung'. (*Translator.*)

Page 16

†1 To be read as: the class of all classes of elements u such that ϕu , such that nothing is ϕ . (*Edd.*)

Page 25

†1 ab-functions are the truth-functions. Cf. Appendix I. [*Edd.*]

Page 55

†1 I.e. the theory of a proposition as a class. (*Edd.*)

Page 86

†1 Schiller, Prologue to *Wallensteins Lager*. [*Edd.*]

Page 93

†1 Russell for instance imagines every fact as a spatial complex.

Page 94

†1 W-F = Wahr-Falsch--i.e. True-False.

Page 94

†2 This is quite arbitrary but, if we once have fixed on which order the poles have to stand we must of course stick to our convention. If for instance "apb" says p then bpa says *nothing*. (It does not say $\sim p$). But a-apb-b is the same symbol as apb (here the ab-function vanishes automatically) for here the new poles are related to the same side of p as the old ones. The question is always: how are the new poles correlated to p compared with the way the old poles are correlated to p.

Page 95

†1 I.e. *sich verhalten*, are related. *Edd.*

Page 95

†2 I.e. *sich verhält*, is related. *Edd.*

Page 99

†1 *Sic* in Russell's MS.; but comparison with the *Tractatus* shows that "without knowing" has fallen out after 'paper'. *Edd.*

Page 104

†1 I.e. *sich verhalten zu*, are related to. *Edd.*

Page 108

†1 Square brackets round whole sentences or paragraphs are Wittgenstein's; otherwise they mark something supplied in editing.

Page 111

†1 This paragraph is lightly deleted.

Page 112

†1 ξ is Frege's mark of an *Argumentstelle*, to show that ψ is a *Funktionsbuchstabe*. There are several deleted and partly illegible definitions.

Page 112

†2 Presumably "verhält sich zu", i.e. "stands towards." [*Edd.*]

Page 113

†1 The reader should remember that according to Wittgenstein "'p'" is not a name but a description of the fact constituting the proposition. See above, p. 109. [*Edd.*]

Page 118

†1 Possibly "between the Sheffer-strokes".

Page 123

†1 The foregoing letter; the present extract is a postscript. [*Edd.*]

Page 124

†1 Presumably the 1913 *Notes on Logic*. [*Edd.*]

Page 130

†1 Wittgenstein had sent Russell a copy of the *Tractatus* by the hand of Keynes, and the following letter is a reply to Russell's queries about the book. [*Edd.*]

Page 131

†1 In Russell's symbolism, the cardinal number of the universal class, i.e. of all objects. [*Edd.*]

Page 131

†2 Russell's *Introduction* to the *Tractatus*. [*Edd.*]

Page 133

†* See Preface.

PHILOSOPHICAL REMARKS

Page 1

Page Break 2

Page 2

Ludwig Wittgenstein from Blackwell Publishers

The Wittgenstein Reader

Edited by Anthony Kenny

Zettel

Second Edition

Edited by G.E.M. Anscombe and G.H. von Wright

Remarks on Colour

Edited by G.E.M. Anscombe

Remarks on the Foundations of Mathematics

Third Edition

Edited by G.H. von Wright, Rush Rhees and G.E.M. Anscombe

Philosophical Remarks

Edited by Rush Rhees

Philosophical Grammar

Edited by Rush Rhees

On Certainty

Edited by G.E.M. Anscombe and G.H. von Wright

Lectures and Conversations

Edited by Cyril Barrett

Culture and Value

Edited by G.H. von Wright

The Blue and Brown Books

Preliminary Studies for the *Philosophical Investigations*

Remarks on the Philosophy of Psychology, Vol. I

Edited by G.E.M. Anscombe and G.H. von Wright

Remarks on the Philosophy of Psychology, Vol. II

Edited by G.E.M. Anscombe and Heikki Nyman

Last Writings on the Philosophy of Psychology, Vol. I

Edited by G.H. von Wright and Heikki Nyman

Last Writings on the Philosophy of Psychology, Vol. II

Edited by G.H. von Wright and Heikki Nyman

Philosophical Investigations (German-English edition)

Translated by G.E.M. Anscombe

Page Break 3

Titlepage

Page 3

LUDWIG WITTGENSTEIN

PHILOSOPHICAL REMARKS

Edited from his posthumous
writings by Rush Rhees
and translated into English
by Raymond Hargreaves and
Roger White

BASIL BLACKWELL • OXFORD

Page Break 4

Copyright page

Page 4

Copyright © in this translation

Basil Blackwell 1975

Reprinted 1990, 1998

First German edition 1964

All Rights Reserved. No part of this publication
may be reproduced, stored in a retrieval system,
or transmitted, in any form or by any means, electronic,
mechanical, photocopying, recording or otherwise, without the prior
permission of Blackwell Publishers Limited.

The editor was enabled to prepare this volume for
publication through the generosity of the Nuffield
Foundation. He owes it particular gratitude. R. R.

ISBN 0 631 19130 5

Printed in Great Britain by Athenaeum Press Ltd, Gateshead,
Tyne & Wear.

Page Break 5

Et multi ante nos vitam istam agentes, praestruxerant aerumnosas vias, per quas transire cogebamur multiplicato labore
et dolore filiis Adam.

Augustine

Page Break 6

Page Break 7

Page 7

FOREWORD

This book is written for such men as are in sympathy with its spirit. This spirit is different from the one which informs the vast stream of European and American civilization in which all of us stand. That spirit expresses itself in an onwards movement, in building ever larger and more complicated structures; the other in striving after clarity and perspicuity in no matter what structure. The first tries to grasp the world by way of its periphery--in its variety; the second at its centre--in its essence. And so the first adds one construction to another, moving on and up, as it were, from one stage to the next, while the other remains where it is and what it tries to grasp is always the same.

Page 7

I would like to say 'This book is written to the glory of God', but nowadays that would be chicanery, that is, it would not be rightly understood. It means the book is written in good will, and in so far as it is not so written, but out of vanity, etc., the author would wish to see it condemned. He cannot free it of these impurities further than he himself is free of them.

November 1930

L. W.

Page Break 8

Page Break 9

ANALYTICAL TABLE OF CONTENTS

I

Page 9

1 A proposition is completely logically analysed if its grammar is made clear--in no matter what idiom. All that is possible and necessary is to separate what is essential from what is inessential in our language--which amounts to the construction of a phenomenological language. Phenomenology as the grammar of those facts on which physics builds its theories. 51

Page 9

2 The complexity of philosophy is not in its matter, but in our tangled understanding. 52

Page 9

3 How strange if logic were concerned with an 'ideal' language, and not with *ours*! 52

Page 9

4 If I could describe the point of grammatical conventions by saying they are made necessary by certain properties of the colours (say)--then what would make the conventions superfluous, since in that case I would be able to say precisely that which the conventions exclude my saying. 53

Page 9

5 Might we say: A child must of course learn to speak a particular language, but not to think? 53

Page 9

6 In a certain sense, the use of language is something that cannot be taught. 54

Page 9

7 Grammatical conventions cannot be justified by describing what is represented: any such description already presupposes the grammatical rules. 54

Page Break 10

Page 10

8 The kind of co-ordination on the basis of which a heard or seen language functions would be, say: 'If you hear a shot or see me wave, run.' 55

Page 10

9 Have philosophers hitherto always spoken nonsense? 55

II

Page 10

10 Thinking of propositions as instructions for making models. For it to be possible for an expression to guide my hand, it must have the same multiplicity as the action desired. And this must also explain the nature of negative propositions. 57

Page 10

11 How do I know that I can recognize red when I see it? How do I know it is the colour that I *meant*? 57

Page 10

12 If the image of the colour is not identical with the colour that is really seen, how can a comparison be made?

Page 10

13 Language must have the same multiplicity as a control panel that sets off the actions corresponding to its propositions. 58

Page 10

14 Only the application makes a rod into a lever.--Every instruction can be construed as a description, every description as an instruction. 59

Page 10

15 What does it mean, to understand a proposition as a member of a system of propositions? Its complexity is only to be explained by the use for which it is intended. 59

Page 10

16 How do I know that *that* was what I expected? How do I know that the colour which I now call 'white' is the same as the one I saw here yesterday? By recognizing it again. 59

Page 10

17 Should Logic bother itself with the question whether the

Page Break 11

proposition was merely automatic or thoroughly *thought*? It is interested in the proposition as part of a language system. 60

Page 11

18 I do not believe that logic can talk about sentences [propositions] in any other than the normal sense in which we say, 'There's a sentence written here'. 61

Page 11

19 Agreement of a proposition with reality. We can look at recognition, like memory, in two different ways: as a source of the concepts of the past and of identity, or as a way of checking what happened in the past, and on identity. 61

III

Page 11

20 If you exclude the element of intention from language, its whole function then collapses. 63

Page 11

21 The essential difference between the picture conception (of intention) and Russell's conception is that the former regards recognition as seeing an internal relation. The causal connection between speech and action is an external relation. 63

Page 11

22 I believe Russell's theory amounts to the following: if I give someone an order and I am happy with what he then does, then he has carried out my order. 64

Page 11

23 If, when learning a language, speech, as it were, is connected up to action, can these connections possibly break down? If so, what means have I for *comparing* the original arrangement with the subsequent action? 64

Page 11

24 The intention is already expressed in the way I *now* compare the picture with reality. 65

Page 11

25 Expecting that *p* will be the case must be the same as expecting the fulfilment of this expectation. 65

Page Break 12

Page 12

26 If there were only an external connection, no connection could be described at all, since we only describe the external connection by means of the internal one. 66

Page 12

27 The meaning of a question is the method of answering it. Tell me *how* you are searching, and I will tell you *what* you are searching for. 66

Page 12

28 Expecting is connected with looking for. I know what I am looking for, without what I am looking for having to

exist. The event that replaces an expectation is the reply to it. That of course implies that the expectation must be in the same space as what is expected. 67

Page 12

29 Expectation is not given an *external* description by citing what is expected; describing it by means of what is expected is giving an internal description. 68

Page 12

30 If I say 'This is the same event as I expected' and 'This is the same event as also happened on that occasion', then the word 'same' has a different meaning in each case. 68

Page 12

31 Language and intention. If you say, 'That's a brake lever, but it doesn't work', you are speaking of intention. 69

Page 12

32 I only use the terms expectation, thought, wish, etc. of something which is articulated. 69

Page 12

33 *How* you search in one way or another expresses what you expect. Expectation prepares a yardstick for measuring the event. If there were no connection between expectation and reality, you could expect a nonsense . 70

Page 12

34 If I say that the representation must treat of my world, then I cannot say 'since otherwise I could not verify it', but 'since otherwise it wouldn't even begin to make sense to me'. 71

Page 12

35 The strange thing about expectation is that we know it is an

Page Break 13

expectation. And *that* is what shows expectation is immediately connected with reality. We have to be able to give a description comparing expectation with the present. 72

Page 13

36 What I once called 'objects' were simply that which we can speak about *no matter what may be the case*. 'I expect three knocks on the door.' What if I replied, 'How do you know three knocks *exist*'? 72

Page 13

37 Is a man who cannot see any red around him at present in the same position as someone incapable of seeing red? If one of them imagines red, that is not a red he sees. 73

Page 13

38 The memory and the reality must be in *one* space. Also: the image and the reality are in *one* space. 73

IV

Page 13

39 If I can only see something black and say it isn't red, how do I know that I am not talking nonsense--i.e. that it could be red, that there is red--if red weren't just another graduation mark on the same scale as black? 75

Page 13

40 If there is a valid comparison with a ruler, the word 'blue' must give the direction in which I go from black to blue. But how do these different directions find expression in grammar? 75

Page 13

41 A man with red/green colour blindness has a different colour system from a normal man. Is the question then 'Can someone who doesn't know what red and green are like really see what we call "blue" and "yellow"?' 76

Page 13

42 Grey must already be conceived as being in lighter/darker space. The yardstick must already be applied: I cannot *choose* between *inner* hearing and *inner* deafness. 76

Page Break 14

Page 14

43 For any question there is always a corresponding *method* of finding. You cannot compare a picture with reality unless you can set it against it as a yardstick. 77

Page 14

44 How is a 'formally certified proposition' possible? The application of a yardstick doesn't presuppose any particular length for the object to be measured. That is why I can learn to measure in general.

78

Page 14

45 But are the *words* in the same space as the object whose length is described? The unit length is part of the symbolism, and *it* is what contains the specifically spatial element.

78

Page 14

46 A language using a co-ordinate system. The written sign without the co-ordinate system is senseless.

79

V

Page 14

47 It doesn't strike us at all when we look round us, move about in space, feel our own bodies, etc., etc., because there is nothing that contrasts with the form of our world. The self-evidence of the world expresses itself in the very fact that language can and does only refer to it.

80

Page 14

48 The stream of life, or the stream of the world, flows on and our propositions are so to speak verified only at instants. Then they are commensurable with the present.

80

Page 14

49 Perhaps the difficulty derives from taking the time concept from time in physics and applying it to the course of immediate experience. We don't speak of present, past and future images.

81

Page 14

50 'I do not see the past, only a *picture* of the past.' But how do I know it's a picture of the *past*?

82

Page Break 15

Page 15

51 On the film strip there is a present picture and past and future pictures: but on the screen there is only the present.

83

Page 15

52 We cannot say 'time flows' if by time we mean the possibility of change.--It also appears to us as though memory were a faint picture of what we originally had before us in full clarity. And in the language of physical objects that is so.

83

Page 15

53 But it can also be put *differently*; and that is important. The phrase 'optical illusion', for example, gives the idea of a mistake, even when there is none. One could imagine an absolutely *impartial* language.

84

Page 15

54 Language can only say those things that we can also imagine otherwise. That everything flows must be expressed in the *application* of language. And if someone says only the present *experience* has reality, then the word 'present' must be redundant here.

84

Page 15

55 Certain important propositions describing an experience which might have been otherwise: such as the proposition that my visual field is almost incessantly in a state of flux.

86

Page 15

56 If I make a proposition such as 'Julius Caesar crossed the Alps', do I merely describe my present mental state?--The proposition states what I believe. If I wish to know what that is, the best thing to do is to ask *why* I believe it.

86

VI

Page 15

57 One misleading representational technique in our language is the use of the word "I", particularly when it is used in representing immediate experience. How would it be if such experience were represented without using the personal pronoun?

88

Page Break 16

Page 16

58 Like this, say: If I, L. W., have toothache, that is expressed as 'There is toothache'. In other cases: 'A is behaving

as L. W. does when there is toothache'. Language can have anyone as its centre. That it has me as its centre lies in the application. This privileged status cannot be expressed. Whether I say that what is represented is *not* one thing among others; or that I cannot express the advantage of *my* language--both approaches lead to the same result. 88

Page 16

59 It isn't possible to believe something for which you cannot find some kind of verification. In a case where I believe someone is sad I can do this. But I cannot *believe* that *I* am sad. 89

Page 16

60 Does it make *sense* to say two people have the same body? 90

Page 16

61 What distinguishes *his* toothache from *mine*? 90

Page 16

62 'When I say he has toothache, I mean he now has what I once had.' But is this a relation toothache once had to me and now has to him? 91

Page 16

63 I could speak of toothache (datum of feeling) in someone else's tooth in the sense that it would be possible to feel pain in a tooth in someone else's mouth. 92

Page 16

64 If I say 'A has toothache', I use the image of feeling pain in the same way as, say, the concept of flowing when I talk of an electric current flowing.--The hypotheses that (1) other people have toothache and that (2) they behave just as I do but don't have toothache--possibly have identical senses. 93

Page 16

65 Our language employs the phrases 'my pain' and 'his pain' and also 'I have (or feel) a pain', but 'I feel my pain' or 'I feel his pain' is

Page Break 17

nonsense. 94

Page 17

66 What would it be like if I had two bodies, i.e. my body were composed of two separate organisms?--Philosophers who believe you can, in a manner of speaking, extend experience by thinking, ought to remember you can transmit speech over the telephone, but not measles. 95

VII

Page 17

67 Suppose I had such a good memory that I could remember all my sense impressions. I could then describe them, e.g. by representing the visual images plastically, only finishing them so far as I had actually seen them and moving them with a mechanism. 97

Page 17

68 If I describe a language, I am describing something that belongs to physics. But how can a physical language describe the phenomenal? 97

Page 17

69 A phenomenon (specious present) contains time, but isn't in time. Whereas language unwinds in time. 98

Page 17

70 We need a way of speaking with which we can represent the phenomena of visual space, isolated as such. 98

Page 17

71 Visual space is called subjective only in the language of physical space. The essential thing is that the representation of visual space is the representation of an object and contains no suggestion of a subject. 99

Page 17

72 How can I tell that I see the world through the pupil of my eyeball? Surely not in an essentially different way from that of my seeing it through the window. 100

Page 17

73 In visual space there isn't an eye belonging to me and eyes

Page Break 18

belonging to others. Only the space itself is asymmetrical. 102

74 The exceptional position of my body in visual space derives from other feelings, and not from something purely visual. 102

75 Is the time of isolated 'visual' phenomena the time of our ordinary idioms of physics? I imagine the changes in my visual space are discontinuous and in time with the beats of a metronome. I can then describe them and compare the description with what actually happens. A delusion of memory? No, a delusion that, *ex hypothesi*, cannot be unmasked isn't a delusion. And here the time of my memory is precisely the time I'm describing. 103

VIII

76 Incompatible for red and green to be in *one* place at the same time. What would a mixed colour of red and green be? And different degrees of red are also incompatible with one another.--And yet I can say: 'There's an even redder blue than the redder of these two'. That is, from the given I can construct what is not given.--Is a construction possible within the elementary proposition which doesn't work by means of truth functions and also has an effect on one proposition's following logically from another? In that case, two elementary propositions can contradict one another. 105

77 This is connected with the idea of a *complete description*. 106

78 That *r* and *g* completely occupy the *f*--that doesn't show itself in our signs. But it must show itself if we look, not at the sign, but at the symbol. For since this includes the form of the objects, then the impossibility of '*f*(*r*)•*f*(*g*)' must show itself there in this form. 106

79 That would imply I can write down two particular propositions, but not their logical product? We can say that the '•' has a different meaning here. 107

80 A mixed or intermediate colour of blue and red is such in virtue of an internal relation to the structures of red and blue. But this internal relation is *elementary*. That is, it doesn't consist in the proposition '*a* is blue-red' representing a logical product of '*a* is blue' and '*a* is red'. 107

81 As with colours, so with sounds or electrical charges. It's always a question of the complete description of a certain state at *one* point or at the same time. But how can I express the fact that e.g. a colour is definitively described? How can I bring it about that a second proposition of the same form contradicts the first?--Two elementary propositions can't contradict one another. 108

82 There are rules for the truth functions which also deal with the elementary part of the proposition. In which case propositions become even more like yardsticks. The fact that *one* measurement is right automatically excludes all others. It isn't a proposition that I put against reality as a yardstick, it's a system of propositions. Equally in the case of negative description: I can't be given the zero point without the yardstick. 109

83 The concept of the independent co-ordinates of description. The propositions joined e.g. by 'and' are not independent of one another, they form *one* picture and can be tested for their compatibility or incompatibility. 111

84 In that case every assertion would consist in setting a number of scales (yardsticks), and it's impossible to set one scale simultaneously at two graduation marks. 112

85 That all propositions contain time appears to be accidental when compared with the fact that the truth functions can be applied to any proposition. 112

86 Syntax prohibits a construction such as '*a* is green and *a* is red', but for '*a* is green' the proposition '*a* is red' is not,

so to speak, *another* proposition, but another form of the same proposition. In this way syntax draws together the propositions that make *one* determination. 113

IX

Page 20

87 The general proposition 'I see a circle on a red background'--a proposition which leaves possibilities open. What would this generality have to do with a totality of objects? Generality in this sense, therefore, enters into the theory of elementary propositions. 115

Page 20

88 If I describe only a part of my visual field, my description must necessarily include the whole visual space. The form (the logical form) of the patch in fact presupposes the whole space. 115

Page 20

89 Can I leave some determination in a proposition open, without at the same time specifying precisely what possibilities are left open? 'A red circle is situated in the square.' How do I know such a proposition? Can I ever know it as an endless disjunction? 116

Page 20

90 Generality and negation. 'There is a red circle that is not in the square.' I cannot express the proposition 'This circle is not in the square' by placing the 'not' *at the front of* the proposition. That is connected with the fact that it's nonsense to give a circle a name. 116

Page 20

91 'All circles are in the square' can mean either 'A certain number of circles are in the square' or: 'There is no circle outside it'. But the last proposition is again the negation of a generalization and not the generalization of a negation. 117

Page 20

92 The part of speech is only determined by *all* the grammatical

Page Break 21

rules which hold for a word, and seen from this point of view our language contains countless different parts of speech. 118

Page 21

93 The subject-predicate form does not in itself amount to a logical form. The forms of the propositions: 'The plate is round', 'The man is tall', 'The patch is red', have nothing in common.-- Concept and object: but that is subject and predicate. 118

Page 21

94 Once you have started doing arithmetic, you don't bother about functions and objects.--The description of an object may not express what would be essential for the existence of the object. 119

Page 21

95 If I give names to three visual circles of equal size--I always name (directly or indirectly) a *location*. What characterizes propositions of the form 'This is...' is only the fact that the reality outside the so-called system of signs somehow enters into the symbol. 119

Page 21

96 What remains in this case, if form and colour alter? For position is part of the form. It is clear that the phrase 'bearer of a property' conveys a completely wrong--an impossible--picture. 120

Page 21

97 Roughly speaking, the equation of a circle is the sign for the concept 'circle'. So it is as if what corresponds with the objects falling under the concept were here the co-ordinates of the centres. In fact, the number pair that gives the co-ordinates of the centre is not just anything, but characterizes just what in the symbol constitutes the 'difference' of the circles. 121

Page 21

98 The specification of the 'here' must not prejudice *what* is here. $F(x)$ must be an *external* description of x .--but if I now say 'Here is a circle' and on another occasion 'Here is a sphere', are the two 'here's' of the same kind? 122

Page Break 22

X

Page 22

99 Number and concept. Does it make sense to ascribe a number to objects that haven't been brought under a concept? But I can e.g. form the concept, 'link between a and b '. 123

Page 22

100 Numbers are pictures of the extensions of concepts. We could regard the extension of a concept as an object whose name has sense only in the context of a proposition. In the symbolism there is an actual correlation, whereas at the level of meaning only the possibility of correlation is at issue. 124

Page 22

101 I can surely always distinguish 3 and 4 in the sign $1 + 1 + 1 + 1 + 1 + 1 + 1$. 124

Page 22

102 Numbers can only be defined from propositional *forms*, independently of the question which propositions are true or false. The possibility of grouping these 4 apples into 2 and 2 refers to the sense, not the truth of a proposition. 125

Page 22

103 Can a proposition (A) in PM notation give the sense of $5 + 7 = 12$? But how have I obtained the numerical sign in the right-hand bracket if I don't know that it is the result of adding the two left-hand signs? 125

Page 22

104 What tells us that the 5 strokes and the 7 combine *precisely to make 12* is always only insight into the internal relations of the structures--not some logical consideration. 127

Page 22

105 An extension is a characteristic of the sense of a proposition. 127

Page 22

106 What A contains apart from the arithmetical schema can only be what is necessary in order to apply it. But nothing at all is necessary. 128

Page 22

107 No investigation of concepts can tell us that $3 + 2 = 5$;

Page Break 23

equally it is not an examination of concepts which tells us that A is a tautology. Numbers must be of a kind with what we use to represent them. 129

Page 23

108 Arithmetic is the grammar of numbers. 129

Page 23

109 Every mathematical calculation is an application of itself and only as such does it have a sense. *That* is why it isn't necessary to speak about the general form of logical operation here.--Arithmetic is a more general kind of geometry. 130

Page 23

110 It's as if we're surprised that the numerals cut adrift from their definitions function so unerringly; which is connected with the internal consistency of geometry. The general form of the application of arithmetic seems to be represented by the fact that *nothing* is said about it. 131

Page 23

111 Arithmetical constructions are autonomous, like geometrical ones, and hence they guarantee their own applicability. 132

Page 23

112 If 3 strokes on paper are the sign for the number 3, then you can say the number 3 is to be applied in the way in which 3 strokes can be applied. (Cf. §107) 133

Page 23

113 A statement of number about the extension of a concept is a proposition, but a statement of number about the range of a variable is not, since it can be derived from the variable itself. 133

Page 23

114 Do I know there are 6 permutations of 3 elements in the same way in which I know there are 6 people in this room? No. Therefore the first proposition is of a different *kind* from the second. 134

XI

Page 23

115 A statement of number doesn't always contain something general or indefinite. For instance, 'I see 3 equal circles equidistant from one another'. Something indefinite would be, say: I know that three things have the property ϕ , but I don't know *which*.

Page Break 24

Here it would be nonsense to say I don't know which *circles* they are. 136

Page 24

116 There is no such concept as 'pure colour'. Similarly with permutations. If we say that $A B$ admits of two permutations, it sounds as though we had made a general assertion. But 'Two permutations are possible' cannot say any less--i.e. something more general--than the schema $A B, B A$. They are not the extension of a concept: they are the concept. 137

Page 24

117 There is a mathematical question: 'How many permutations of 4 elements are there?' which is the same kind as 'What is 25×18 ?' For in both cases there is a general method of solution. 139

Page 24

118 In Russell's theory only an *actual* correlation can show the "similarity" of two classes. Not the *possibility* of correlation, for this consists precisely in the numerical equality. 140

Page 24

119 What sort of an *impossibility* is the impossibility of a 1-1 correlation between 3 circles and 2 crosses?--It is nonsense to say of an extension that it has such and such a number, since the number is an *internal* property of the extension. 140

Page 24

120 Ramsey explains the sign '=' like this: $x = x$ is taut.; $x = y$ is cont. What then is the relation of 'Def' to '='?--You may compare mathematical equations only with significant propositions, not with tautologies. 141

Page 24

121 An equation is a rule of syntax. You may construe sign-rules as propositions, but you don't *have to* construe them so. The 'heterological' paradox. 143

Page 24

122 The generality of a mathematical assertion is different from the generality of the proposition proved. A mathematical proposition is an allusion to a proof. A generalization only makes sense if it--i.e. all values of its variables--is completely determined. 143

Page Break 25

XII

Page 25

123 I grasp an infinite stretch in a different way from an endless one. A proposition about it can't be verified by a putative endless striding, but only in *one* stride. 146

Page 25

124 It isn't just impossible 'for us men' to run through the natural numbers one by one; it's *impossible*, it means nothing. The totality is only given as a concept. 146

Page 25

125 That, in the case of the logical concept $(1, \xi, \xi + 1)$, the existence of its objects is already given with the concept, of itself shows that it determines them. What is fundamental is simply the repetition of an operation. The operation $+ 1$ three times yields and *is* the number 3. 147

Page 25

126 It looks now as if the quantifiers make no sense for numbers. 148

Page 25

127 If no finite product makes a proposition true, that means *no* product makes it true. And so it *isn't* a logical product. 148

Page 25

128 Can I know that a number satisfies the equation without a finite section of the infinite series being marked out as one within which it occurs? 149

Page 25

129 A proposition about all propositions, or all functions, is impossible. *Generality* in arithmetic is indicated by an induction. 150

Page 25

130 The defect (circle) in Dedekind's explanation of the concept of infinity lies in its application of the concept 'all' in the formal implication. What really corresponds to what we mean isn't a proposition at all, it's the *inference* from ϕx to ψx , if this inference is permitted--but the inference isn't expressed by a proposition. 151

131 Generality in Euclidean geometry. Strange that what holds for one triangle should therefore hold for every other. But once more the construction of a proof is not an experiment; no, a description of the construction must suffice.--What is demonstrated can't be expressed by a proposition. 152

132 'The world will *eventually* come to an end' means nothing at all, for it's compatible with this statement that the world should still exist on any day you care to mention. 'How many 9s immediately succeed one another after 3.1415 in the development of π ?' If this question is meant to refer to the extension, then it doesn't have the sense of the question which interests us. ('I grasp an infinite stretch in a different way from an endless one.') 153

133 The difficulty in applying the simple basic principles shakes our confidence in the principles themselves. 153

134 'I saw the ruler move from t_1 to t_2 , *therefore* I must have seen it at t .' If in such a case I appear to infer a particular case from a general proposition, then the general proposition is never derived from experience, and the proposition isn't a real proposition. 154

135 'We only know the infinite by description.' Well then, there's just the description and nothing else. 155

136 Does a notation for the infinite presuppose infinite space or infinite time? Then the possibility of such a hypothesis must surely be prefigured somewhere. The problem of the smallest visible distinction. 155

137 If I cannot visibly bisect the strip any further, I can't even *try* to, and so can't see the failure of such an attempt. Continuity in our visual field consists in our not seeing discontinuity. 156

138 Experience as experience of the facts gives me the finite; the objects *contain* the infinite. Of course, not as something rivalling finite experience, but in intension. (Infinite possibility is *not* a quantity.) Space has no extension, only spatial objects are extended, but infinity is a property of space. 157

139 Infinite divisibility: we can conceive of *any* finite number of parts but not of an infinite number; but that is precisely what constitutes infinite divisibility.--That a patch in visual space can be divided into three parts means that a proposition describing a patch divided in this way makes sense. Whereas infinite divisibility doesn't mean there's a proposition describing a line divided into infinitely many parts. Therefore this possibility is not brought out by any reality of the signs, but by a possibility of a *different* kind in the signs themselves. 158

140 Time contains the possibility of all the future *now*. The space of human movement is infinite in the same way as time. 160

141 The rules for a number system--say, the decimal system--contain everything that is infinite about the numbers.--It all hangs on the syntax of reality and possibility. $m = 2n$ contains the *possibility of correlating any number* with another, *but doesn't correlate all numbers with others*. 161

142 The propositions 'Three things can lie in this direction' and 'Infinitely many things can lie in this direction' are only apparently formed in the same way, but are in fact different in structure: the 'infinitely many' of the second structure doesn't play the same role as the 'three' of the first. 162

143 Empty infinite time is only the possibility of facts which alone are the realities.--If there is an infinite reality, then there is also contingency in the infinite. And so, for instance, also an

infinite decimal that isn't given by a law.--Infinity lies in the nature of time, it isn't the extension it happens to have.

163

Page 28

144 The infinite number series is only the infinite possibility of finite series of numbers. The signs themselves only contain the possibility and not the reality of their repetition. Mathematics can't even try to speak about their possibility. If it tries to *express* their possibility, i.e. when it confuses this with their reality, we ought to cut it down to size.

164

Page 28

145 An infinite decimal not given by a rule. 'The number that is the result when a man endlessly throws a die', appears to be nonsense.--An infinite row of trees. If there is a law governing the way the trees' heights vary, then the series is defined and can be imagined by means of this law. If I now assume there could be a random series, then that is a series about which, by its very nature, nothing can be known apart from the fact that I can't know it.

165

Page 28

146 The multiplicative axiom. In the case of a finite class of classes we can in fact make a selection. But in the case of infinitely many sub-classes I can only know the law for making a selection. Here the infinity is only in the rule.

167

Page 28

147 What makes us think that perhaps there are infinitely many things is only our confusing the things of physics with the elements of knowledge. 'The patch lies somewhere between *b* and *c*': the infinite possibility of positions isn't expressed in the analysis of this.--The illusion of an infinite hypothesis in which the parcels of matter are confused with the simple objects. What we can imagine multiplied to infinity are the combinations of the things in accordance with their infinite possibilities, never the things themselves.

168

Page Break 29

XIII

Page 29

148 While we've as yet no idea how a certain proposition is to be proved, we still ask 'Can it be proved or not?' You cannot have a logical plan of search for a *sense* you don't know. Every proposition teaches us through its sense how we are to convince ourselves whether it is true or false.

170

Page 29

149 A proof of relevance would be a proof which, while yet not proving the proposition, showed the form of a method for testing the proposition.

170

Page 29

150 I can assert the general (algebraic) proposition just as much or as little as the equation $3 \times 3 = 9$ or $3 \times 3 = 11$. The general method of solution is in itself a clarification of the nature of the equation. Even in a particular case I see only the rule. 'The equation yields *a*' means: if I transform the equation in accordance with certain rules I get *a*. But these rules must be given to me before the word 'yields' has a meaning and before the question has a sense.

172

Page 29

151 We may only put a question in mathematics where the answer runs: 'I must work it out'. The question 'How many solutions are there to this equation?' is the holding in readiness of the general method for solving it. And that, in general, is what a question is in mathematics: the holding in readiness of a general method.

175

Page 29

152 I can't ask whether an angle can be trisected until I can see the system 'Ruler and Compasses' embedded in a larger one, where this question has a sense.--The system of rules determining a calculus thereby determines the 'meaning' of its signs too. If I change the rules, then I change the form, the meaning.--In mathematics, we cannot talk of systems in general, but only within systems.

177

Page 29

153 A mathematical proof is an analysis of a mathematical

Page Break 30

proposition. It isn't enough to say that *p* is provable, we have to say: provable according to a particular system. Understanding *p* means understanding its system.

179

Page 30

154 I can ask 'What is the solution of this equation?', but not 'Has it a solution?'--It's impossible for us to discover rules of a new type that hold for a form with which we are familiar.--The proposition: 'It's possible--though not

necessary--that p should hold for all numbers' is nonsense. For 'necessary' and 'all' belong together in mathematics.
181

Page 30

155 Finding a new system (Sheffer's discovery, for instance). You can't say: I already had all these results, now all I've done is find a better way that leads to all of them. The new way amounts to a new system.

182

Page 30

156 Unravelling knots in mathematics. We may only speak of a genuine attempt at a solution *to the extent* that the structure of the knot is clearly seen.

184

Page 30

157 You can't write mathematics, you can only do it.--Suppose I hit upon the right way of constructing a regular pentagon by accident. If I don't understand this construction, as far as I'm concerned it doesn't even begin to be the construction of a pentagon. The way I have arrived at it vanishes in what I understand.

186

Page 30

158 Where a connection is now known to exist which was previously unknown, there wasn't a gap before, something incomplete which has now been filled in.--Induction: if I know the law of a spiral, that's in many respects analogous with the case in which I know all the whorls. Yet not completely analogous--and that's all we can say.

Page 30

159 But doesn't it still count as a question, whether there is a finite number of primes or not? Once I can write down the general form of primes, e.g. 'dividing... by smaller numbers leaves a

Page Break 31

remainder'--there is no longer a question of 'how many' primes there are. But since it was possible for us to have the phrase 'prime number' before we had the strict expression, it was also possible for people to have wrongly formed the question. Only in our verbal language are there in mathematics 'as yet unsolved problems'.

188

Page 31

160 A consistency proof can't be essential for the application of the axioms. For these are propositions of syntax.

189

Page 31

161 A polar expedition and a mathematical one. How can there be conjectures in mathematics? Can I make a hypothesis about the distribution of primes? What kind of verification do I then count as valid? I can't conjecture the proof. And if I've got the proof it doesn't prove what was conjectured.

189

Page 31

162 Sheffer's discovery. The systems are certainly not in *one* space, so that I could say: there are systems with 3 and 2 logical constants, and now I'm trying to reduce the number of constants *in the same way*.--A mathematical proposition is only the immediately visible surface of a whole body of proof and this surface is the boundary facing us.

191

XIV

Page 31

163 A proof for the associative law? As a basic rule of the system it cannot be proved. The usual mistake lies in confusing the extension of its application with what the proof genuinely contains.--Can one prove that by addition of forms $((1 + 1) + 1)$ etc. numbers of this form would always result? The proof lies in the rule, i.e. in the definition and in nothing else.

193

Page 31

164 A recursive proof is only a general guide to arbitrary special proofs: the general form of continuing along this series. Its

Page Break 32

generality is not the one we desire but consists in the fact that we can repeat the proof. What we gather from the proof we cannot represent in a proposition at all.

196

Page 32

165 The correct expression for the associative law is not a proposition, but precisely its 'proof', which admittedly doesn't state the law. I know the specific equation is correct just as well as if I had given a complete derivation of it. That means it really is proved. The *one* whorl, in conjunction with the numerical forms of the given equation, is enough.

198

166 One says an induction is a sign that such and such holds for all numbers. But an induction isn't a sign for anything but itself.--Compare the generality of genuine propositions with generality in arithmetic. It is differently verified and so is of a different kind. 200

167 An induction doesn't prove an algebraic equation, but it justifies the setting up of algebraic equations from the standpoint of their application to arithmetic. That is, it is only through the induction that they gain their sense, not their truth. An induction is related to an algebraic proposition not as proof is to what is proved, but as what is designated to a sign. 201

168 If we ask 'Does $a + (b + c) = (a + b) + c$?', what could we be after?--An algebraic proposition doesn't express a generality; this is shown, rather, in the formal relation to the substitution, which proves to be a term of the inductive series. 202

169 One can prove any arithmetical equation of the form $a \times b = c$ or prove its opposite. A proof of this provability would be the exhibition of an induction from which it could be seen what sort of propositions the ladder leads to. 204

XV

170 The theory of aggregates says that you can't grasp the actual infinite by means of arithmetical symbolism at all, it can therefore only be described and not represented. So one could talk about a logical structure without reproducing it in the proposition itself. A method of wrapping a concept up in such a way that its form disappears. 206

171 Any proof of the continuity of a function must relate to a number system. The numerical scale, which comes to light when calculating a function, should not be allowed to disappear in the general treatment.--Can the continuum be described? A form cannot be described: it can only be presented. 207

172 'The highest point of a curve' doesn't mean 'the highest point among all the points of the curve'. In the same way, the maximum of a function isn't the largest value among all its values. No, the highest point is something I *construct*, i.e. derive from a law. 208

173 The expression '(n)...' has a sense if nothing more than the unlimited possibility of going on is presupposed.--Brouwer--. The explanation of the Dedekind cut as if it were clear what was meant by: either R has a last member and L a first, or, etc. In truth none of these cases can be conceived. 209

174 Set theory builds on a fictitious symbolism, therefore on nonsense. As if there were something in Logic that could be known, but not by us. If someone says (as Brouwer does) that for $(x) \cdot f_1x = f_2x$ there is, as well as yes and no, also the case of undecidability, this implies that '(x)...' is meant extensionally and that we may talk of all x happening to have a property. 211

175 If one regards the expression 'the root of the equation $\phi x = 0$ ' as a Russellian description, then a proposition about the

root of the equation $x + 2 = 6$ must have a different sense from one saying the same about 4. 213

176 How can a purely internal generality be refuted by the occurrence of a single case (and so by something extensional)? But the particular case refutes the general proposition from within--it attacks the internal proof.--The difference between the two equations $x^2 = x \cdot x$ and $x^2 = 2x$ isn't one consisting in the extensions of their validity. 214

XVI

177 That a point in the plane is represented by a number-pair, and in three-dimensional space by a number-triple, is

enough to show that the object represented isn't the point at all but the point-network.

216

Page 34

178 Geometry as the syntax of the propositions dealing with objects in space. Whatever is arranged in visual space stands in this *sort* of order *a priori*, i.e. in virtue of its logical nature, and geometry here is simply grammar. What the physicist sets into relation with one another in the geometry of physical space are instrument readings, which do not differ in their *internal* nature whether we live in a linear space or a spherical one.

216

Page 34

179 I can approach any point of an interval indefinitely by always carrying out the bisection prescribed by tossing a coin. Can I divide the rationals into two classes in a similar way, by putting either 0 or 1 in an infinite binary expansion according to the way the coin falls (heads or tails)? No law of succession is described by the instruction to toss a coin; and infinite indefiniteness does not define a number.

218

Page 34

180 Is it possible within the law to abstract from the law and see the extension presented as what is essential?--If I cut at a place

Page Break 35

where there is no rational number, then there must be approximations to this cut. But closer to what? For the time being I have nothing in the domain of number which I can approach.--All the points of a line can actually be represented by arithmetical rules. In the case of approximation by repeated bisection we approach *every* point via *rational* numbers.

221

XVII

Page 35

181 What criterion is there for the irrational numbers being *complete*? Every irrational number runs through a series of rational approximations, and never leaves this series behind. If I have the totality of all irrational numbers except π , and now insert π , I cannot cite a point at which π is really needed; at every point it has a companion agreeing with it. This shows clearly that an irrational number isn't the extension of an infinite decimal fraction, it's a law. If π were an extension, we would never feel the lack of it--it would be impossible for us to detect a gap.

223

Page 35

182 ' $\sqrt{2}$ ': a rule with an exception.--There must first be the rules for the digits, and then--e.g.--a root is expressed in them. But this expression in a sequence of digits only has significance through being the expression for a real number. If someone subsequently alters it, he has only succeeded in distorting the expression, but not in obtaining a new number.

224

Page 35

183 If ' $\sqrt{2}$ ' is anything at all, then it is the same as $\sqrt{2}$, only another expression for it; the expression in another system. It doesn't measure until it is in a system. You would no more say of ' $\sqrt{2}$ ' that it is a limit towards which the sums of a series are tending than you would of the instruction to throw dice.

225

Page 35

184 That we can apply the law holds also for the law to throw digits like dice. And what distinguishes π ' from this can only consist in our knowing that there must be a law governing the occurrences

Page Break 36

of the digit 7 in π , even if we don't yet know what the law is. π ' alludes to a law which is as yet unknown.

227

Page 36

185 Only a law approaches a value.

228

Page 36

186 The letter π stands for a law which has its position in arithmetical space. Whereas π ' doesn't use the idioms of arithmetic and so doesn't assign the law a place in this space. For substituting 3 for 7 surely adds absolutely nothing to the law and in this system isn't an arithmetical operation at all.

228

Page 36

187 To determine a real number a rule must be completely intelligible *in itself*. That is to say, it must not be essentially undecided whether a part of it could be dispensed with. If the extensions of two laws coincide as far as we've gone, and I cannot compare the laws as such, then the numbers defined cannot be compared.

Page 36

188 The expansion of π is simultaneously an expression of the nature of π and of the nature of the decimal system. Arithmetical operations only use the decimal system as a means to an end. They can be translated into the language of any other number system, and do not have any of them as their *subject matter*.--A general rule of operation gets its generality from the generality of the change it effects in the numbers. π ' makes the decimal system into its subject matter, and for that reason it is no longer sufficient that we can use the rule to form the extension. 231

Page 36

189 A law where p runs through the series of whole numbers except for those for which Fermat's last theorem doesn't hold. Would this law define a real number? The number F wants to use the spiral... and choose sections of this spiral according to a principle. But this principle doesn't belong to the spiral. There is admittedly a law there, but it doesn't refer directly to the number. The number is a sort of lawless by-product of the law.

232

Page Break 37

XVIII

Page 37

190 In this context we keep coming up against something that could be called an 'arithmetical experiment'. Thus the primes come out from the method for looking for them, as the results of an experiment. I can certainly see a law in the rule, but not in the numbers that result.

235

Page 37

191 A number must measure in and of itself. If it doesn't do that but leaves it to the rationals, we have no need of it.--The true expansion is the one which evokes from the law a comparison with a rational number.

235

Page 37

192 A real number can be compared with the fiction of an infinite spiral, whereas structures like F , P or π ' only with finite sections of a spiral.

237

Page 37

193 To compare rational numbers with $\sqrt{2}$, I have to square them.--They then assume the form \sqrt{a} , where \sqrt{a} is now an arithmetical operation. Written out in this system, they can be compared with $\sqrt{2}$, and it is for me as if the spiral of the irrational number had shrunk to a point.

237

Page 37

194 Is an arithmetical experiment still possible when a recursive definition has been set up? No, because with the recursion each stage becomes arithmetically comprehensible.

238

Page 37

195 Is it possible to prove a greater than b , without being able to prove at which place the difference will come to light? 1.4--Is that the square root of 2? No, it's the root of 1.96. That is, I can immediately write it down as an approximation to $\sqrt{2}$.

238

Page 37

196 If the real number is a rational number a , a comparison of its law with a must show this. That means the law must be so formed as to 'click into' the rational number when it comes to the

Page Break 38

appropriate place. It wouldn't do, e.g., if we couldn't be sure whether $\sqrt{25}$ really breaks off at 5.

240

Page 38

197 Can I call a spiral a number if it is one which, for all I know, comes to a stop at a rational point? There is a lack of a method for comparing with the rationals. Expanding indefinitely isn't a method, even when it leads to a result of the comparison.

241

Page 38

198 If the question how F compares with a rational number has no sense, since all expansion still hasn't given us an answer, then this question also had no sense before we tried to settle the matter at random by means of an extension.

242

Page 38

199 It isn't only necessary to be able to say whether a given rational number is the real number: we must also be able

to say how close it can possibly come to it. An order of magnitude for the distance apart. Decimal expansion doesn't give me this, since I cannot know e.g. how many 9s will follow a place that has been reached in the expansion.--'e isn't this number' means nothing; we have to say 'It is at least this interval away from it'.

243

Page 38

Appendix: From F. Waismann's shorthand notes of a conversation on 30 December 1930

245

XIX

Page 38

200 It appears to me that negation in arithmetic is interesting only in conjunction with a certain generality.--Indivisibility and inequality.--I don't write ' $\sim(5 \times 5 = 30)$ ', I write $5 \times 5 \neq 30$, since I'm not negating anything but want to establish a relation between 5×5 and 30 (and hence something positive). Similarly, when I exclude divisibility, this is equivalent to establishing indivisibility.

247

Page Break 39

Page 39

201 There is something recalcitrant to the application of the law of the excluded middle in mathematics--Looking for a law for the distribution of primes. We want to replace the negative criterion for a prime number by a positive one--but this negation isn't what it is in logic, but an indefiniteness.--The negation of an equation is as like and as unlike the denial of a proposition as the affirmation of an equation is as like or unlike the affirmation of a proposition.

248

Page 39

202 Where negation essentially--on logical grounds--corresponds to a disjunction or to the exclusion of one part of a logical series in favour of another--then here it must be one and the same as those logical forms and therefore only apparently a negation.

249

Page 39

203 Yet what is expressed by inequalities is *essentially* different from what is expressed by equations. And so you can't immediately compare a law yielding places of a decimal expansion which works with inequalities, with one that works with equations. Here we have completely different methods and consequently different kinds of arithmetical structure.

250

Page 39

204 Can you use the prime numbers to define an irrational number? As far as you can foresee the primes, and no further.

251

XX

Page 39

205 Can we say a patch is simpler than a larger one?--It seems as if it is impossible to see a uniformly coloured patch as composite.--The larger *geometrical* structure isn't composed of smaller *geometrical* structures. The 'pure geometrical figures' are of course only logical possibilities.

252

Page 39

206 Whether it makes sense to say 'This part of a red patch is red' depends on whether there is absolute position. It's possible to

Page Break 40

establish the identity of a position in the visual field, since we would otherwise be unable to distinguish whether a patch always stays in the same place. In visual space there is absolute position, absolute direction, and hence absolute motion. If this were not so, there would be *no sense* in speaking in this context of the same or different places. This shows the structure of our visual field: for the criterion for its structure is what propositions make sense for it.

253

Page 40

207 Can I say: 'The top half of my visual field is red'?--There isn't a relation of 'being situated' which would hold between a colour and a position.

257

Page 40

208 It seems to me that the concept of distance is given immediately in the structure of visual space. Measuring in visual space. Equal in length, unequal in parts. Can I be sure that what I count is really the number I see?

257

Page 40

209 But if I can't say there is a definite number of parts in a and b , how in that case am I to describe the visual

image?--'Blurred' and 'unclear' are relative expressions.--If we were really to see 24 and 25 parts in *a* and *b*, we couldn't then see *a* and *b* as equal. The word 'equal' has a meaning even for visual space which stamps this as a contradiction. 260

Page 40

210 The question is, how to explain certain contradictions that arise when we apply the methods of inference used in Euclidean space to visual space. This happens because we can only see the construction piecemeal and not as a whole: because there's no visual construction that could be composed of these individual visual pieces. 261

Page 40

211 The moment we try to apply exact concepts of measurement to immediate experience, we come up against a peculiar vagueness in this experience.--The words 'rough', 'approximate', etc. have

Page Break 41

only a relative sense, but they are still needed and they characterize the nature of our experience.--Problem of the heap of sand.--What corresponds in Euclidean geometry to the visual circle isn't a circle, but a class of figures.--Here it seems as though an exact *demarkation* of the inexactitude is impossible. We border off a swamp with a wall, and the wall is not *the* boundary of the swamp. 263

Page 41

212 The correlation between visual space and Euclidean space. *If* a circle is at all the sort of thing we see, then we must be able to see *it* and not merely something like it. If I cannot see an exact circle then in this sense neither can I see approximations to one. 265

Page 41

213 We need new concepts and we continually resort to those of the language of physical objects. For instance 'precision'. If it is right to say 'I do not see a sharp line', then a sharp line *is* conceivable. If it makes sense to say 'I never see an exact circle', then this implies: an exact circle is conceivable in visual space.--The word 'equal' used with quite different meanings.--Description of colour patches close to the boundary of the visual field. Clear that the lack of clarity is an internal property of visual space. 266

Page 41

214 What distinctions are there in visual space? The fact that you see a physical hundred-sided polygon as a circle implies nothing as to the *possibility* of seeing a hundred-sided polygon. Is there a *sense* in speaking of a visual hundred-sided polygon? 268

Page 41

215 Couldn't I say, 'Perhaps I see a perfect circle, but can never know it'? Only if it is established in what cases one calls one measurement more precise than another. It means nothing to say the circle is only an ideal to which reality can only approximate. But it may also be that we call an infinite possibility itself a circle. As with an irrational number.--Now, is the imprecision of measurement the same concept as the imprecision of visual images? Certainly not.--'Seems' and 'appears' ambiguous: in one

Page Break 42

case it is the result of measurement, in another a further appearance. 269

Page 42

216 'Sense datum' contains the idea: if we talk about 'the appearance of a tree' we are either taking for a tree something which is one, or something which is not. But this connection isn't there. 270

Page 42

217 *Can* you try to give 'the right model for visual space'? You cannot translate the blurredness of phenomena into an imprecision in the drawing. That visual space isn't Euclidean is already shown by the occurrence of two different kinds of lines and points. 271

XXI

Page 42

218 Simple colours--simple as psychological phenomena. I need a purely phenomenological colour theory in which mention is only made of what is actually perceptible and no hypothetical objects--waves, rods, cones and all that--occur. Can I find a metric for colours? Is there a sense in saying, e.g., that with respect to the amount of red in it, one colour is *halfway* between two other colours? 273

Page 42

219 Orange is a mixture of red and yellow in a sense in which yellow isn't a mixture of red and green although yellow comes between red and green in the colour circle.--If I imagine mixing a blue-green with a yellow-green I see straightaway that it can't happen, that a component part would first have to be 'killed'.

Page 42

220 I must know what in general is meant by the expression 'mixture of colours *A* and *B*'. If someone says to me that the colour of a patch lies between violet and red, I understand this and can imagine a redder violet than the one given. But: 'The colour lies

Page Break 43

between this violet and an orange?' The way in which the mixed colour lies between the others is no different here from the way red comes between blue and yellow.--'Red and yellow make orange' doesn't speak of a quantity of components. It means nothing to say this orange and this violet contain the same amount of red.--False comparison between the colour series and a system of two weights on a balance. 274

Page 43

221 The position here is just as it is with the geometry of visual space as compared with Euclidean geometry. There are here quantities of a different sort from that represented by our rational numbers.--If the expression 'lie between' on one occasion designates a mixture of two simple colours, and on another a simple component common to two mixed colours, the multiplicity of its application is different in the two cases.--You can also arrange all the shades along a straight line. But then you have to introduce rules to exclude certain transitions, and in the end the representation on the lines has to be given the same kind of topological structure as the octahedron has. Completely analogous to the relation of ordinary language to a 'logically purified' mode of expression. 276

Page 43

222 We can't say red has an orange tinge in the same sense as orange has a reddish tinge. '*x* is composed of *y* and *z*' and '*x* is the common component of *y* and *z*' are not interchangeable here. 278

Page 43

223 When we see dots of one colour intermingled with dots of another we seem to have a different sort of colour transition from that on the colour-circle. Not that we establish experimentally that certain colours arise in this way from others. For whether or not such a transition is *possible* (or conceivable) is an internal property of the colours. 279

Page 43

224 The danger of seeing things as simpler than they really are. Understanding a Gregorian mode means hearing something new; analogous with suddenly seeing 10 strokes, which I had hitherto only been able to see as twice five strokes, as a characteristic whole. 281

Page Break 44

XXII

Page 44

225 A proposition, an hypothesis, is coupled with reality--with varying degrees of freedom. All that matters is that the signs in the end still refer to immediate experience and not to an intermediary (a thing in itself). A proposition construed in such a way that it can be uncheckably true or false is completely detached from reality and no longer functions as a proposition. 282

Page 44

226 An hypothesis is a symbol for which certain rules of representation hold. The choice of representation is a process based on so-called induction (not mathematical induction). 283

Page 44

227 We only give up an hypothesis for an even higher gain. The question, how simple a representation is yielded by assuming a particular hypothesis, is connected with the question of probability. 284

Page 44

228 What is essential to an hypothesis is that it arouses an expectation, i.e., its confirmation is never completed. It has a different formal relation to reality from that of verification.--Belief in the uniformity of events. An hypothesis is a law for forming propositions. 285

Page 44

229 The probability of an hypothesis has its measure in how much evidence is needed to make it profitable to throw it out. If I say: I assume the sun will rise again tomorrow, because the opposite is so unlikely, I here mean by 'likely' and 'unlikely' something completely different from 'It's equally likely that I'll throw heads or tails'.--The expectation must make sense *now*; i.e. I must be able to compare it with how things stand at present. 286

Page 44

Page Break 45

world of material things compared with a phenomenological description.--Thus the theory of Relativity doesn't represent the logical multiplicity of the phenomena themselves, but that of the regularities observed. This multiplicity corresponds not to *one* verification, but to a *law* by verifications. 286

Page 45

231 Hypothesis and postulate. No conceivable experience can refute a postulate, even though it may be extremely inconvenient to hang on to it. Corresponding to the greater or slighter convenience, there is a greater or slighter probability of the postulate. It is senseless to talk of a measure for this probability. 288

Page 45

232 If I say 'That will probably occur', this proposition is neither verified by the occurrence nor falsified by its non-occurrence. If we argue about whether it is probable or not, we shall always adduce arguments from the past only.--It's always as if the same state of affairs could be corroborated by experience, whose existence was evident *a priori*. But that's nonsense. If the experience agrees with the computation, that means my computation is justified by the experience--not its *a priori* element, but its bases, which are *a posteriori*: certain natural laws. In the case of throwing a die the natural law takes the form that it is equally likely for any of the six sides to be the side uppermost. It's this law that we test. 289

Page 45

233 Certain possible events must contradict the law if it is to be one at all; and should these occur, they must be explained by a different law.--The prediction that there will be an equal distribution contains an assumption about those natural laws that I don't know precisely. 290

Page 45

234 A man throwing dice every day for a week throws nothing but ones--and not because of any defect in the die. Has he grounds

Page Break 46

for thinking that there's a natural law at work here which makes him throw nothing but ones?--When an insurance company is guided by probability, it isn't guided by the probability calculus but by a frequency actually observed. 291

Page 46

235 'Straight line with deviations' is only one form of description. If I state 'That's the rule', that only has a sense as long as I have determined the maximum number of exceptions I'll allow before knocking down the rule. 292

Page 46

236 It only makes sense to say of the stretch you actually see that it gives the general impression of a straight line, and not of an hypothetical one you assume. An experiment with dice can only give grounds for expecting things to go in the same way. 293

Page 46

237 Any 'reasonable' expectation is an expectation that a rule we have observed up to now will continue to hold. But the rule must have been observed and can't, for its part too, be merely expected.--Probability is concerned with the form and a standard of expectation. 294

Page 46

238 A ray of light strikes two different surfaces. The centre of each stretch seems to divide it into equally probable possibilities. This yields apparently incompatible probabilities. But the assumption of the probability of a certain event is verified by a frequency experiment; and, if confirmed, shows itself to be an hypothesis belonging to *physics*. The geometrical construction merely shows that the equal lengths of the sections was *no* ground for assuming equal likelihood. I can arbitrarily lay down a law, e.g. that if the lengths of the parts are equal, they are equally likely; but any other law is just as permissible. Similarly with further examples. It is from experience that we determine these possibilities as equally likely. But logic gives this stipulation no precedence. 295

Page Break 47

First Appendix

Page 47

Complex and Fact

Second Appendix (from F. Waismann's shorthand notes on Wittgenstein's talks and conversation between December 1929 and September 1931)

Page 47

Yardstick and Propositional System	317
Consistency	318
Editor's Note	347
Translators' Note	352
Corrigenda for the German text	355

Page Break 48

Page Break 49

PHILOSOPHICAL REMARKS

Page 49

Page Break 50

Page Break 51

I

Page 51

1 A proposition is completely logically analysed if its grammar is made completely clear: no matter what idiom it may be written or expressed in.

Page 51

I do not now have phenomenological language, or 'primary language' as I used to call it, in mind as my goal. I no longer hold it to be necessary. All that is possible and necessary is to separate what is essential from what is inessential in *our* language.

Page 51

That is, if we so to speak describe the class of languages which serve their purpose, then in so doing we have shown what is essential to them and given an immediate representation of immediate experience.

Page 51

Each time I say that, instead of such and such a representation, you could also use this other one, we take a further step towards the goal of grasping the essence of what is represented.

Page 51

A recognition of what is essential and what inessential in our language if it is to represent, a recognition of which parts of our language are wheels turning idly, amounts to the construction of a phenomenological language.

Page 51

Physics differs from phenomenology in that it is concerned to establish laws. Phenomenology only establishes the possibilities. Thus, phenomenology would be the grammar of the description of those facts on which physics builds its theories.

Page 51

To explain is more than to describe; but every explanation contains a description.

Page 51

An octahedron with the pure colours at the corner-points e.g. provides a *rough* representation of colour-space, and this is a grammatical representation, not a psychological one. On the other hand, to say that in such and such circumstances you can see a red

Page Break 52

after-image (say) is a matter of psychology. (*This* may, or may not, be the case--the other is *a priori*; we can establish the one by experiment but not the other.)

Page 52

Using the octahedron as a representation gives us a *bird's-eye view* of the grammatical rules [†1].

Page 52

The chief trouble with our grammar is that we don't have a *bird's-eye view* of it [†2].

Page 52

What Mach calls a thought experiment is of course not an experiment at all [†3]. At bottom it is a grammatical investigation.

Page 52

2 Why is philosophy so complicated? It ought, after all, to be *completely* simple. Philosophy unties the knots in our thinking, which we have tangled up in an absurd way; but to do that, it must make movements which are just as complicated as the knots. Although the *result* of philosophy is simple, its methods for arriving there cannot be so.

Page 52

The complexity of philosophy is not in its matter, but in our tangled understanding.

Page 52

3 How strange if logic were concerned with an 'ideal' language and not with *ours*. For what would this ideal language express? Presumably, what we now express in our ordinary language; in that case, this is the language logic must investigate. Or something else: but in that case how would I have any idea what that would be?--Logical analysis is the analysis of something we have, not of something we don't have. Therefore it is the analysis of propositions *as they stand*. (It would be odd if the human race had been speaking all this time without ever putting together a genuine proposition.)

Page 52

When a child learns 'Blue is a colour, red is a colour, green, yellow--all are colours', it learns nothing new about the colours,

Page Break 53

but the meaning of a variable in such propositions as: 'There are beautiful colours in that picture' etc. The first proposition tells him the values of a variable.

Page 53

The words 'Colour', 'Sound', 'Number' etc. could appear in the chapter headings of our grammar. They need not occur within the chapters but that is where their structure is given.

Page 53

4 Isn't the theory of harmony at least in part phenomenology and therefore grammar?

Page 53

The theory of harmony isn't a matter of taste.

Page 53

If I could describe the point of grammatical conventions by saying they are made necessary by certain properties of the colours (say), then that would make the conventions superfluous, since in that case I would be able to say precisely that which the conventions exclude my saying. Conversely, if the conventions were necessary, i.e. if certain combinations of words had to be excluded as nonsensical, then for that very reason I cannot cite a property of colours that makes the conventions necessary, since it would then be conceivable that the colours should not have this property, and I could only express that by violating the conventions.

Page 53

It cannot be proved that it is nonsense to say of a colour that it is a semitone higher than another. I can only say 'If anyone uses words with the meanings that I do, then he can connect no sense with this combination. If it makes sense to him, he must understand something different by these words from what I do.'

Page 53

5 The arbitrariness of linguistic expressions: might we say: A child must of course learn to speak a particular language, but doesn't have to learn to think, i.e. it would think spontaneously, even without learning any language?

Page 53

But in my view, if it thinks, then it forms for itself pictures and in a certain sense these are arbitrary, that is to say, in so far as other

Page Break 54

pictures could have played the same role. On the other hand, language has certainly also come about naturally, i.e. there must presumably have been a first man who for the first time expressed a definite thought in spoken words. And besides, the whole question is a matter of indifference because a child learning a language only learns it by beginning to think in it. Suddenly beginning; I mean: there is no preliminary stage in which a child already uses a language, so to speak uses it for communication, but does not yet think in it.

Page 54

Of course, the thought processes of an ordinary man consist of a medley of symbols, of which the strictly linguistic perhaps form only a small part.

Page 54

6 If I explain the meaning of a word 'A' to someone by pointing to something and saying 'This is A', then this expression may be meant in two different ways. Either it is itself a proposition already, in which case it can only be

understood once the meaning of 'A' is known, i.e. I must now leave it to chance whether he takes it as I meant it or not. Or the sentence is a definition. Suppose I have said to someone 'A is ill', but he doesn't know who I mean by 'A', and I now point at a man, saying 'This is A'. Here the expression is a definition, but this can only be understood if he has already gathered what kind of object it is through his understanding of the grammar of the proposition 'A is ill'. But this means that any kind of explanation of a language presupposes a language already. And in a certain sense, the use of language is something that cannot be taught, i.e. I cannot use language to teach it in the way in which language could be used to teach someone to play the piano.--And that of course is just another way of saying: I cannot use language to get outside language.

Page 54

7 Grammar is a 'theory of logical types'.

Page Break 55

Page 55

I do not call a rule of representation a convention if it can be justified in propositions: propositions describing what is represented and showing that the representation is adequate. Grammatical conventions cannot be justified by describing what is represented. Any such description already presupposes the grammatical rules. That is to say, if anything is to count as nonsense in the grammar which is to be justified, then it cannot at the same time pass for sense in the grammar of the propositions that justify it (etc.).

Page 55

You cannot use language to go beyond the possibility of evidence.

Page 55

The possibility of explaining these things always depends on someone else using language in the same way as I do. If he states that a certain string of words makes sense to him, and it makes none to me, I can only suppose that in this context he is using words with a different meaning from the one I give them, or else is speaking without thinking.

Page 55

8 Can anyone believe it makes sense to say 'That's not a noise, it's a colour'?

Page 55

On the other hand, you can of course say 'It's not the noise but the colour that makes me nervous', and here it might look as if a variable assumed a colour and a noise as values. ('Sounds and colours can be used as vehicles of communication.') It is clear that this proposition is of the same kind as 'If you hear a shot or see me wave, run.' For this is the kind of co-ordination on the basis of which a heard or seen language functions.

Page 55

9 Asked whether philosophers have hitherto spoken nonsense, you could reply: no, they have only failed to notice that they are using a word in quite different senses. In this sense, if we say it's nonsense to say that one thing is as identical as another, this needs qualification, since if anyone says this with conviction, then at that

Page Break 56

moment he means something by the word 'identical' (perhaps 'large'), but isn't aware that he is using the word here with a different meaning from that in $2 + 2 = 4$.

Page Break 57

II

Page 57

10 If you think of propositions as instructions for making models, their pictorial nature becomes even clearer.

Page 57

Since, for it to be possible for an expression to guide my hand, it *must* have the same multiplicity as the action desired.

Page 57

And this must also explain the nature of negative propositions. Thus, for example, someone might show his understanding of the proposition 'The book is not red' by throwing away the red when preparing a model.

Page 57

This and the like would also show in what way the negative proposition has the multiplicity of the proposition it denies and *not* of those propositions which could perhaps be true in its stead.

Page 57

11 What does it mean to say 'Admittedly I can't see any red, but if you give me a paint-box, I can point it out to you'? How can you *know* that you will be able to point it out if...; and so, that you will be able to recognize it when

you see it?

Page 57

This might mean two different kinds of things: it might express the expectation that I shall recognize it if I am shown it, in the same sense that I expect a headache if I'm hit on the head; then it is, so to speak, an expectation that belongs to physics, with the same sort of grounds as any other expectation relating to the occurrence of a physical event.--Or else it has nothing to do with expecting a physical event, and for that reason neither would my proposition be falsified if such an event should fail to occur. Instead, it's as if the proposition is saying that I possess a paradigm that I could at any time compare the colour with. (And the 'could' here is logical possibility.)

Page 57

Taking the first interpretation: if, on looking at a certain colour, I in fact do give a sign of recognition, how do I know it is the colour that I *meant*?

Page Break 58

Page 58

The propositions of our grammar are always of the same sort as propositions of physics and not of the same sort as the 'primary' propositions which treat of what is immediate.

Page 58

12 The idea that you 'imagine' the meaning of a word when you hear or read it, is a naive conception of the meaning of a word. And in fact such imagining gives rise to the same question as a word meaning something. For if, e.g., you imagine sky-blue and are to use this image as a basis for recognizing or looking for the colour, we are still forced to say that the image of the colour isn't the same as the colour that is really seen; and in that case, how can one compare these two?

Page 58

Yet the naive theory of *forming-an-image* can't be utterly wrong.

Page 58

If we say 'A word only has meaning in the context of a proposition', then that means that it's only in a proposition that it functions as a word, and this is no more something that can be said than that an armchair only serves its purpose when it is in space. Or perhaps better: that a cogwheel only functions as such when engaged with other cogs.

Page 58

13 Language must have the same multiplicity as a control panel that sets off the actions corresponding to its propositions.

Page 58

Strangely enough, the problem of *understanding* language is connected with the problem of the Will.

Page 58

Understanding a command before you obey it has an affinity with willing an action before you perform it.

Page 58

Just as the handles in a control room are used to do a wide variety of things, so are the words of language that correspond to the handles. One is the handle of a crank and can be adjusted continuously; one belongs to a switch and is always either on or

Page Break 59

off; a third to a switch which permits three or more positions; a fourth is the handle of a pump and only works when it is being moved up and down, etc.; but all are handles, are worked by hand.

Page 59

14 A word only has meaning in the context of a proposition: that is like saying only in use is a rod a lever. Only the application makes it into a lever.

Page 59

Every instruction can be construed as a description, every description as an instruction.

Page 59

15 What does it mean, to understand a proposition as a member of a system of propositions? (It's as if I were to say: the use of a word isn't over in an instant, any more than that of a lever).

Page 59

Imagine a gearbox whose lever can take four positions. Now of course it can only take these positions in succession, and that takes time; and suppose it happened that it only ever occupied one of these positions, since the gearbox was then destroyed. Wasn't it still a gearbox with *four* positions? Weren't the four possible?

Page 59

Anyone who saw it would have seen its complexity, and its complexity is only to be explained by the use for which it was intended, to which in fact it was not put. Similarly I would like to say in the case of language: What's the point of all these preparations; they only have any meaning if they find a use.

Page 59

You might say: The sense of a proposition is its purpose. (Or, of a word 'Its meaning is its purpose'.)

Page 59

But the natural history of the use of a word can't be any concern of logic.

Page 59

16 If I expect an event and that which fulfils my expectation occurs, does it then make sense to ask whether that really is the

Page Break 60

event I expected? i.e. how would a proposition that asserted this be verified? It is clear that the *only* source of knowledge I have here is a comparison of the *expression* of my expectation with the event that has occurred.

Page 60

How do I know that the colour of this paper, which I call 'white', is the same as the one I saw here yesterday? By recognizing it again; and recognizing it again is my only source of knowledge here. In that case, 'That it is the same' *means* that I recognize it again.

Page 60

Then of course you also can't ask whether it really is the same and whether I might not perhaps be mistaken; (whether it *is* the same and doesn't just *seem* to be.)

Page 60

Of course, it would also be possible to say that the colour is the same because chemical investigations do not disclose any change. So that if it doesn't look the same to me then I am mistaken. But even then there must still be something that is immediately recognized.

Page 60

And the 'colour' I can recognize immediately and the one I establish by chemical investigation are two different things.

Page 60

One source only yields *one* thing.

Page 60

17 Is it an objection to my view that we often speak half or even entirely automatically? If someone asks me 'Is the curtain in this room green?' and I look and say, 'No, red', I certainly don't have to hallucinate green and compare it with the curtain. No, just looking at the curtain can automatically produce the answer, and yet this answer is of interest to Logic, whereas a whistle, say, that I make automatically on seeing red is not. Isn't the point that Logic is only interested in this answer as a part of a language system? The system our books are written in. Could we say Logic considers language *in extenso*? And so, in the same way as grammar.

Page 60

Could you say that Logic has nothing to do with that utterance if it was merely automatic? For should Logic bother itself with the question whether the proposition was also really thoroughly

Page Break 61

thought? And what would the criterion for that be? Surely not the lively play of images accompanying its expression I It is plain that here we have got into a region that is absolutely no concern of ours and from which we should retire with the utmost alacrity.

Page 61

18 Here we come to the apparently trivial question, what does Logic understand by a word--is it an ink-mark, a sequence of sounds, is it necessary that someone should associate a sense with it, or should have associated one, etc., etc.?--And here, the crudest conception must obviously be the only correct one.

Page 61

And so I will again talk about 'books'; here we have words; if a mark should happen to occur that looks like a word, I say: that's not a word, it only looks like one, it's obviously unintentional. This can only be dealt with from the standpoint of normal common sense. (It's extraordinary that that in itself constitutes a change in perspective.)

Page 61

I do not believe that Logic can talk about sentences [\dagger 1] in any other than the normal sense in which we say, 'There's a sentence written here' or 'No, that only looks like a sentence, but isn't', etc., etc.

Page 61

The question 'What is a word?' is completely analogous with the question 'What is a chessman?'

Page 61

19 Isn't it agreement and disagreement that is primary, just as recognition is what is primary and identity what is secondary? If we see a proposition verified, what higher court is there to which we could yet appeal in order to tell whether it *really* is true?

Page 61

The agreement of a proposition with reality only resembles the agreement of a picture with what it depicts to the same extent as the agreement of a memory image with the present object.

Page Break 62

Page 62

But we can look at recognition, like memory, in two different ways: as a source of the concepts of the past and of identity, or as a way of checking what happened in the past, and on identity.

Page 62

If I can see two patches of colour alongside one another and say that they have the same colour, and if I say that this patch has the same colour as one I saw earlier, the identity assertion means something different in the two cases, since it is differently verified.

Page 62

To know that it *was* the same colour is something different from knowing that it *is* the same colour.

Page Break 63

III

Page 63

20 You can draw a plan from a description. You can translate a description into a plan.

Page 63

The rules of translation here are not essentially different from the rules for translating from one verbal language into another.

Page 63

A wrong conception of the way language functions destroys, of course, the *whole* of logic and everything that goes with it, and doesn't just create some merely local disturbance.

Page 63

If you exclude the element of intention from language, its whole function then collapses.

Page 63

21 What is essential to intention is the picture: the picture of what is intended.

Page 63

It may look as if, in introducing intention, we were introducing an uncheckable, a so-to-speak metaphysical element into our discussion. But the essential difference between the picture conception and the conception of Russell, Ogden and Richards, is that it regards recognition as seeing an internal relation, whereas in their view this is an external relation.

Page 63

That is to say, for me, there are only two things involved in the fact that a thought is true, i.e. the thought and the fact; whereas for Russell, there are three, i.e. thought, fact and a third event which, if it occurs, is just recognition. This third event, a sort of satisfaction of hunger (the other two being hunger and eating a particular kind of food), could, for example, be a feeling of pleasure. It's a matter of complete indifference here how we describe this third event; that is irrelevant to the essence of the theory.

Page Break 64

Page 64

The causal connection between speech and action is an external relation, whereas we need an internal one.

Page 64

22 I believe Russell's theory amounts to the following: if I give someone an order and I am happy with what he then does, then he has carried out my order.

Page 64

(If I wanted to eat an apple, and someone punched me in the stomach, taking away my appetite, then it was this punch that I originally wanted.)

Page 64

The difficulty here in giving an account of what's going on is that if someone makes false assumptions about the way language works and tries to give an account of something with language conceived as functioning in this way, the result is not something false but nonsense.

Page 64

Thus in terms of Russell's theory I could not express things by saying that the order is carried out *if* I am made happy by what happens, because I have also to recognise my being made happy, and this requires that something *else* should happen which I cannot describe in advance.

Page 64

23 Suppose you were now to say: pictures do occur, but they are not what is regular; but how strange then, if they happen to be there and a conflict were now to arise between the two criteria of truth and falsity. How should it be adjudicated?

Page 64

In that case, there would, of course, be no distinction between a command and its countermand, since both could be obeyed in the same way.

Page 64

If when a language is first learnt, speech, as it were, is connected up to action--i.e. the levers to the machine--then the question arises, can these connections possibly break down? If they can't, then I have to accept any action as the right one; on the other hand if they can, what criterion have I for their having broken down? For what means have I for *comparing* the original arrangement with the subsequent action?

Page Break 65

Page 65

It is such *comparison* which is left out in Russell's theory. And comparison doesn't consist in confronting the representation with what it represents and through this confrontation experiencing a phenomenon, which, as I have said, itself could not be described in advance.

Page 65

(Experience decides whether a proposition is true or false, but not its sense.)

Page 65

24 How is a picture meant? The intention never resides in the picture itself, since, no matter how the picture is formed, it can always be meant in different ways. But that doesn't mean that the way the picture is meant only emerges when it elicits a certain reaction, for the intention is already expressed in the way I *now* compare the picture with reality.

Page 65

In philosophy we are always in danger of giving a mythology of the symbolism, or of psychology: instead of simply saying what everyone knows and must admit.

Page 65

What if someone played chess and, when he was mated, said, 'Look, I've won, for *that* is the goal I was aiming at'? We would say that such a man simply wasn't trying to play chess, but another game; whereas Russell would have to say that if anyone plays with the pieces and is satisfied with the outcome, then he has won at chess.

Page 65

I expect that the rod will be 2 m high *in the same sense* in which it is now 1 m 99 cm high.

Page 65

25 The fulfilment of an expectation doesn't consist in a third thing happening which you could also describe in another way than just as 'the fulfilment of the expectation', thus for example as a feeling of satisfaction or pleasure or whatever.

Page 65

For expecting that *p* will be the case must be the same as expecting that this expectation will be fulfilled; whereas, if I am wrong,

Page Break 66

expecting *p* would be different from expecting that this expectation will be fulfilled.

Page 66

Isn't it like this: My theory is completely expressed in the fact that the state of affairs satisfying the expectation of *p* is represented by the proposition *p*? And so, not by the description of a *totally* different event.

Page 66

26 I should like to say, if there were only an external connection no connection could be described at all, since we only describe the external connection by means of the internal one. If this is lacking, we lose the footing we need for

describing anything at all--just as we can't shift anything with our hands unless our feet are planted firmly.

Page 66

Causality rests on an observed uniformity. Now, that doesn't mean that a uniformity we have observed until now will go on for ever, but it must be an established fact that events have been uniform until now; *that* cannot in turn be the insecure result of a series of observations which again is itself not a datum, but depends on another equally insecure series, etc. *ad inf.*

Page 66

If I wish that *p* were the case, then of course *p* is not the case and there must be a surrogate for *p* in the state of wishing, just as, of course, in the expression of the wish.

Page 66

There's nothing left for me, in answer to the question, 'What does *p* instruct you to do?', but to say it, i.e. to give another sign.

Page 66

But can't you give someone an instruction by showing him how to do something? Certainly: and then you have to tell him 'Now copy that'. Perhaps you have already had examples of this before but now you have to say to him that what happened then should happen now. That still means: sooner or later there is a leap from the sign to what is signified.

Page 66

27 The meaning of a question is the method of answering it: then what is the meaning of 'Do two men really mean the same by the word "white"?'

Page Break 67

Page 67

Tell me *how* you are searching, and I will tell you *what* you are searching for.

Page 67

If I understand an order but do not carry it out, then understanding it can only consist in a process which is a *surrogate* for its execution, and so in a *different* process from its execution.

Page 67

I should like to say, assuming the surrogate process to be a picture doesn't get me anywhere, since even that does not do away with the transition from the picture to what is depicted.

Page 67

If you were to ask: 'Do I expect the future itself, or only something similar to the future?', that would be nonsense. Or, if you said, 'We can never be certain that *that* was what we really expected.'

Page 67

Co-ordinating signals always contains something general, otherwise the coordination is unnecessary. It is a co-ordination which has to be understood in the particular case.

Page 67

If I say to someone that it will be fine *tomorrow*, he gives evidence of his having understood by not trying to verify the proposition *now*.

Page 67

28 Expecting is connected with looking for: looking for something presupposes that I know what I am looking for, without what I am looking for having to exist.

Page 67

Earlier I would have put this by saying that searching presupposes the elements of the complex, but not *the* combination that I was looking for.

Page 67

And that isn't a bad image: for, in the case of language, that would be expressed by saying that the sense of a proposition only presupposes the grammatically correct use of certain words.

Page 67

How do I know that I have found *that* which I was looking for? (That what I expected has occurred, etc.)

Page 67

I cannot confront the previous expectation with what happens.

Page 67

The event that replaces the expectation, is a reply to it.

Page Break 68

Page 68

But for that to be so, necessarily *some* event must take its place, and that of course implies that the expectation must be in the same space as what is expected.

Page 68

In this context I am talking about an expectation only as something that is necessarily either fulfilled or disappointed: therefore not of an expectation in the void.

Page 68

29 The event which takes the place of an expectation, answers it: i.e. the replacement constitutes the answer, so that no question can arise whether it really is the answer. Such a question would mean putting the *sense* of a proposition in question. 'I expect to see a red patch' describes, let's say, *my present mental state*. 'I see a red patch' describes what I expect: a completely different event from the first. Couldn't you now ask whether the word 'red' has a different meaning in the two cases? Doesn't it look as if the first proposition uses an alien and inessential event to describe my mental state? Perhaps like this: I now find myself in a state of expectation which I characterize by saying that it is satisfied by the event of my seeing a red patch. That is, as though I were to say 'I am hungry and know from experience that eating a particular kind of food will or would satisfy my hunger.' But expectation isn't like that! Expectation is not given an external description by citing what is expected, as is hunger by citing what food satisfies it--in the last resort the appropriate food of course can still only be a matter of conjecture. No, describing an expectation by means of what is expected is giving an internal description.

Page 68

The way the word 'red' is used is *such that* it has a use in all these propositions: 'I expect to see a red patch', 'I remember a red patch', 'I am afraid of a red patch', etc.

Page 68

30 If I say 'This is the same event as I expected', and 'This is the same event as also happened on that occasion', then the word

Page Break 69

'same' has two different meanings. (And you wouldn't normally say 'This is the same as I expected' but 'This is what I expected'.)

Page 69

Could we imagine any language at all in which expecting p was described without using ' p '?

Page 69

Isn't that *just as* impossible as a language in which $\sim p$ would be expressed without using ' p '?

Page 69

Isn't this simply because *expectation* uses the same symbol as the thought of its fulfilment?

Page 69

For if we think in signs, then we also expect and wish in signs.

Page 69

(And you could almost say that someone could hope in German and fear in English, or vice versa.)

Page 69

31 Another mental process belonging to this group, and which ties in with all these things, is *intention*. You could say that language is like a control room operated with a particular *intention* or built for a particular purpose.

Page 69

If a mechanism is *meant* to act as a brake, but for some reason accelerates a machine then the purpose of the mechanism cannot be found out from it alone.

Page 69

If you were then to say 'That's a brake lever but it doesn't work', you would be talking about intention. It is just the same as when we still call a broken clock a clock.

Page 69

(Psychological--trivial--discussions of expectation, association, etc. always leave out what is really remarkable, and you notice that they talk all around, without touching on the vital point.)

Page 69

32 I only use the terms the expectation, thought, wish, etc., that p will be the case, for processes having the multiplicity that finds

Page Break 70

expression in p , and thus only if they are *articulated*. But in that case they are what I call the interpretation of signs.

Page 70

I only call an *articulated* process a thought: you could therefore say 'only what has an articulated

expression'.

Page 70

(Salivation--no matter how precisely measured--is *not* what I call expecting.)

Page 70

Perhaps we have to say that the phrase 'interpretation of signs' is misleading and instead we ought to say 'the use of signs'. For 'interpretation' makes it sound as if one were now to correlate the word 'red' with the colour (when it isn't even there), etc. And now the question again arises: what is the connection between sign and world? Could I look for something unless the space were there to look for it in?

Page 70

Where does the sign link up with the world?

Page 70

33 To look for something is, surely, an expression of expectation. In other words: How you search in one way or another expresses what you expect.

Page 70

Thus the idea would be: what expectation has in common with reality is that it refers to another point in the *same* space. ('Space' in a completely general sense.)

Page 70

I see a patch getting nearer and nearer to the place where I expect it.

Page 70

If I say I remember a colour--say, the colour of a certain book--you could take as evidence for this the fact that I was in a position to mix this colour or recognize it again, or say of other colours that they are more like or less like the colour I remember.

Page 70

Expectation, so to speak, prepares a yardstick for measuring the event when it comes and what's more, in such a way that it will necessarily be possible to measure the one with the other, whether the event coincides with the expected graduation mark or not.

Page 70

It is, say, as if I guess a man's height by looking at him, saying

Page Break 71

'I believe he's 5 ft 8 in' and then set about measuring him with a tape measure. Even if I don't know how tall he is, I still know that his height is measured with a tape measure and not a weighing machine.

Page 71

If I expect to see red, then I *prepare* myself for red.

Page 71

I can prepare a box for a piece of wood to fit in, just because the wood, whatever it's like, must have a volume.

Page 71

If there were no connection between the act of expectation and reality, you could expect a nonsense.

Page 71

34 The expectation of p and the occurrence of p correspond perhaps to the hollow shape of a body and the solid shape. Here p corresponds to the shape of the volume, and the different ways in which this shape is given correspond to the distinction between expectation and occurrence.

Page 71

If I say 'I can make you a sketch of that any time you like', then that presupposes that I *am* in the same space as the business involved.

Page 71

Our expectation anticipates the event. In this sense, it makes a model of the event. But we can only make a model of a fact in *the* world we live in, i.e. the model must be essentially related to the world we live in and what's more, independently of whether it's true or false.

Page 71

If I say that the representation must treat of my world, then you cannot say 'since otherwise I could not verify it', but 'since otherwise it wouldn't even begin to make sense to me'.

Page 71

35 In expecting, the part corresponding to searching in a space is the directing of one's attention.

Page Break 72

Page 72

Surely the strange thing about expectation is that we know that it is an *expectation*. For we couldn't, e.g., imagine the following situation: I have some image or other before me and say: 'Now, I don't know whether it's an expectation or a memory, or an image without any relation to reality.'

Page 72

And *that* is what shows that expectation is immediately connected with reality.

Page 72

For of course you couldn't say that the future the expectation speaks of--I mean the concept of the future--was also only a surrogate for the real future.

Page 72

For I await in just as real a sense as I *wait*.

Page 72

Could you also say: You cannot describe an expectation unless you can describe the present reality; or, you cannot describe an expectation unless you can give a description *comparing* the expectation with the present, of the form: Now I see a red circle *here*, and expect a blue square *there later on*.

Page 72

That is to say the yardstick of language must be applied at the point which is present and then points out beyond it--roughly speaking, in the direction of the expectation.

Page 72

36 It only makes sense to give the length of an object if I have a method for finding the object--since otherwise I cannot apply a yardstick to it.

Page 72

What I once called 'objects', simples, were simply what I could refer to without running the risk of their possible non-existence; i.e. that for which there is neither existence nor non-existence, and that means: what we can speak about *no matter what may be the case*.

Page 72

The visual table is not composed of electrons.

Page 72

What if someone said to me 'I expect three knocks on the door' and I replied 'How do you know *three* knocks exist?'--Wouldn't that be just like the question 'How do you know six feet exist?' after someone has said 'I believe A is 6 feet high'?

Page Break 73

Page 73

37 Can absolute silence be confused with inner deafness, meaning having no acquaintance with the concept of sound? If that were so, you couldn't distinguish lacking the sense of hearing from lacking any other sense.

Page 73

But isn't this exactly the same question as: 'Is a man who cannot see any red around him at present, in the same position as someone incapable of seeing red?'

Page 73

You could of course say: The one can still imagine red, but the red we imagine is not the same as the red we see.

Page 73

38 Our ordinary language has no means for describing a particular shade of a colour, such as the brown of my table. Thus it is incapable of producing a picture of this colour.

Page 73

If I want to tell someone what colour some material is to be, I send him a sample, and obviously this sample belongs to language; and equally the memory or image of a colour that I conjure by a word, belongs to language.

Page 73

The memory and the reality must be in *one* space.

Page 73

I could also say: the image and the reality are in *one* space.

Page 73

If I compare two colour samples in front of me with one another, and if I compare a colour sample with my image of a sample, that is similar to comparing, on the one hand, the lengths of two rods standing up against each other and on the other of two that are apart. In that case, I can say perhaps, they are the same height, if, turning my gaze horizontally, I can glance from the tip of the one to the tip of the other.

As a matter of fact I have never seen a black patch become gradually lighter and lighter until it is white and then redden until it is red; but I know that this would be possible because I can imagine it; i.e. I operate with my images in colour space and do with them what would be possible with the colours. And my words

take their sense from the fact that they more or less completely reflect the operations of the images perhaps in the way in which a score can be used to describe a piece of music that has been played, but for example, does *not* reproduce the emphasis on each individual note.

Grammar gives language the necessary degrees of freedom.

IV

39 The colour octahedron is grammar, since it says that you can speak of a reddish blue but not of a reddish green, etc.

If I can only see something black and say it isn't red, how do I know that I am not talking nonsense, i.e. that it could be red, that there is red? Unless red is just another graduation mark on the same scale as black. What is the difference between 'That is not red' and 'That is not abracadabra'? Obviously I need to know that 'black', which describes the actual state of affairs (or is used in describing it), is that in whose place 'red' stands in the description.

But what does that mean? How do I know it isn't 'soft' in whose place 'red' stands? Can you say red is less different from black than from soft? That would of course be nonsense.

40 How far can you compare the colours with points on a scale?

Can you say that the direction leading from black to red is a different one from the one you must take from black to blue?

For, if there is black in front of me and I am expecting red, that's different from having black in front of me and expecting blue. And if there is a valid comparison with a ruler, the word 'blue' must so to speak give me the direction in which I go from black to blue; so to speak the method by which I reach blue.

Couldn't we also say: 'The proposition must give a construction for the position of blue, the point the fact must reach if such and such is to be blue'?

The fact that I can say that one colour comes closer to what I expected than another belongs here.

But how do these different directions find expression in grammar? Isn't it the same case as my seeing a grey and saying 'I expect this grey to go darker'? How does grammar deal with the distinction between 'lighter' and 'darker'? Or, how can the ruler going from white to black be applied to grey in a particular direction?

It's still as if grey were only *one* point; and how can I see the two *directions* in that? And yet I should be able to do so somehow or other if it is to be possible for me to get to a particular place in these directions [+1].

41 The feeling is as if, for it to negate p , $\sim p$ has in a certain sense first to make it true. One asks 'What isn't the case?' This must be represented but cannot be represented in such a way that p is actually made true.

A man with red/green colour blindness has a different colour system from a normal man. He will be like a man whose head was fixed in one position and so had a different kind of space, since for him there would only be visual space and therefore, e.g., no 'behind'. That wouldn't of course mean that Euclidean space was bounded for him. But that--at least as far as seeing things was concerned--he wouldn't acquire the concept of Euclidean space. Is the question then: can someone who doesn't know what red and green are like, really see what we (or I) call 'blue'?

and 'yellow'?

Page 76

This question must, of course, be just as nonsensical as the question whether someone else with normal vision really sees the same as I do.

Page 76

42 Grey must already be conceived as being in lighter/darker space if I want to talk of its being possible for it to get darker or lighter.

Page 76

So you might perhaps also say: the yardstick must already be applied, I cannot apply it how I like; I can only pick out a point on it.

Page 76

This amounts to saying: if I am surrounded by absolute silence,

Page Break 77

I cannot join (construct) or not join auditory space on to this silence as I like, i.e. either it is for me 'silence' as opposed to a sound, or the word 'silence' has no meaning for me, i.e. I cannot *choose* between inner hearing and *inner* deafness.

Page 77

And in just the same way, I cannot while I am seeing greyness *choose* between normal inner vision and partial or complete colour-blindness.

Page 77

Suppose we had a device for completely cutting out our visual activity so that we could lose our sense of sight; and suppose I had so cut it out: could I say in such circumstances 'I can see a yellow patch on a red background'? Could this way of talking make *sense* to me?

Page 77

43 I should like to say: for any question there is always a corresponding *method* of finding.

Page 77

Or you might say, a question *denotes* a method of searching.

Page 77

You can only search in a *space*. For only in space do you stand in a relation to where you are not.

Page 77

To understand the sense of a proposition means to know how the issue of its truth or falsity is to be decided.

Page 77

The essence of what we call the will is immediately connected with the continuity of the given.

Page 77

You must find the way from where you are to where the issue is decided.

Page 77

You cannot search wrongly; you *cannot* look for a visual impression with your sense of touch.

Page 77

You cannot compare a picture with reality, unless you can set it against it as a yardstick.

Page 77

You must be able to fit the proposition on to reality.

Page Break 78

Page 78

The reality that is perceived takes the place of the picture.

Page 78

If I am to settle whether two points are a certain distance apart, I must look at the distance that *does* separate them.

Page 78

44 How is a 'formally certified proposition' possible? It would be a proposition that you could tell was true or false by looking at it. But how can you discover by inspecting the proposition or thought that it is true? The thought is surely something quite different from the state of affairs asserted by the proposition.

Page 78

The method of taking measurements, e.g. spatial measurements, is related to a particular measurement in precisely the same way as the sense of a proposition is to its truth or falsity.

Page 78

The use, the application, of a yardstick doesn't presuppose any particular length for the object to be measured.

Page 78

That is why I can learn how to measure in general, without measuring *every* measurable object. (This isn't simply an analogy, but is in fact an example.)

Page 78

All that I need is: I must be able to be certain I can apply my yardstick.

Page 78

Thus if I say 'Three more steps and I'll see red', that presupposes that at any rate I can apply the yardsticks of length and colour.

Page 78

Someone may object that a scale with a particular height marked on it can say that something has that height, but not *what* has it.

Page 78

I would then perhaps reply that all I can do is say that something 3 m away from me in a certain direction is 2 m high.

Page 78

45 I will count any fact whose obtaining is a presupposition of a proposition's making sense, as belonging *to language*.

Page 78

It's easy to understand that a ruler is and must be in the same space as the object measured by it. But in what sense are *words* in

Page Break 79

the same space as an object whose length is described in words, or, in the same space as a colour, etc.? It sounds absurd.

Page 79

A black colour can become lighter but not louder. That means that it is in light/dark space but not loud/soft space.--But surely the object just stops being black when it becomes lighter. But in that case it was black and just as I can see movement (in the ordinary sense), I can see a colour movement.

Page 79

The unit length is part of the symbolism. It belongs to the method of projection. Its length is arbitrary, but *it* is what contains the specifically spatial element.

Page 79

And so if I call a length '3', the 3 signifies via the unit length presupposed in the symbolism.

Page 79

You can also apply these remarks to time.

Page 79

46 When I built language up by using a coordinate system for representing a state of affairs in space, I introduced into language an element which it doesn't normally use. This device is surely permissible. And it shows the connection between language and reality. The written sign without the coordinate system is senseless. Mustn't we then use something similar for representing colours?

Page 79

If I say something is three feet long, then that presupposes that somehow or other I am given the foot length. In fact it is given by a description: in such and such a place there is a rod one foot long. The 'such and such a place' indirectly describes a method for getting there; otherwise the specification is senseless. The place name 'London' only has a sense if it is possible to *try to find* London.

Page 79

A command is only then complete, when it makes sense no matter what may be the case. We might also say: That is when it is completely analysed.

Page Break 80

Page 80

47 That it doesn't strike us at all when we look around us, move about in space, feel our own bodies, etc., etc., shows how natural these things are to us. We do not notice that we see space perspectively or that our visual field is in

some sense blurred towards the edges. It doesn't strike us and never can strike us because it is *the* way we perceive. We never give it a thought and it's impossible we should, since there is nothing that contrasts with the form of our world.

Page 80

What I wanted to say is it's strange that those who ascribe reality only to things and not to our ideas [†1] move about so unquestioningly in the world as idea [†1] and never long to escape from it.

Page 80

In other words, how much of a matter of course the given is. It would be the very devil if this were a tiny picture taken from an oblique, distorting angle.

Page 80

This which we take as a matter of course, *life*, is supposed to be something accidental, subordinate; while something that normally never comes into my head, reality!

Page 80

That is, what we neither can nor want to go beyond would not be the world.

Page 80

Time and again the attempt is made to use language to limit the world and set it in relief--but it can't be done. The self-evidence of the world expresses itself in the very fact that language can and does only refer to it.

Page 80

For since language only derives the way in which it means from its meaning, from the world, no language is conceivable which does not represent this world.

Page 80

48 If the world of data is timeless, how can we speak of it at all?

Page Break 81

Page 81

The stream of life, or the stream of the world, flows on and our propositions are so to speak verified only at instants.

Page 81

Our propositions are only verified by the present.

Page 81

So they must be so constructed that they can be verified by it. And so in some way they must be commensurable with the present; and they cannot be so *in spite of* their spatio-temporal nature; on the contrary this must be related to their commensurability as the corporeality of a ruler is to its being extended--which is what enables it to measure. In this case, too, you cannot say: 'A ruler does measure in spite of its corporeality; of course a ruler which only has length would be the Ideal, you might say the *pure* ruler'. No, if a body has length, there can be no length without a body and although I realize that in a certain sense only the ruler's length measures, what I put in my pocket still remains the ruler, the body, and isn't the length.

Page 81

49 Perhaps this whole difficulty stems from taking the time concept from time in physics and applying it to the course of immediate experience. It's a confusion of the time of the film strip with the time of the picture it projects. For 'time' has one meaning when we regard memory as the source of time, and another when we regard it as a picture preserved from a past event.

Page 81

If we take memory as a picture, then it's a picture of a physical event. The picture fades, and I notice how it has faded when I compare it with other evidence of what happened. In this case, memory is not the source of time, but a more or less reliable custodian of what 'actually' happened; and this is something we can know about in other ways, a physical event.--It's quite different if we now take memory to be the source of time. Here it isn't a picture, and cannot fade either--not in the sense in which a picture fades, becoming an ever less faithful representation of its object. Both ways of talking are in order, and are equally legitimate, but cannot be mixed together. It's clear of course that

Page Break 82

speaking of memory as a picture is only a metaphor; just as the way of speaking of images as 'pictures of objects in our minds' (or some such phrase) is a metaphor. We know what a picture is, but images are surely no kind of picture at all. For, in the first case I can see the picture and the object of which it is a picture. But in the other, things are obviously quite different. We have just used a metaphor and now the metaphor tyrannizes us. While in the language

of the metaphor, I am unable to move outside of the metaphor. It must lead to nonsense if you try to use the language of this metaphor to talk about memory as the source of our knowledge, the verification of our propositions. We can speak of present, past and future events in the physical world, but not of present, past and future images, if what we are calling an image is not to be yet another kind of physical object (say, a physical picture which takes the place of the body), but precisely that which is present. Thus we cannot use the concept of time, i.e. the syntactical rules that hold for the names of physical objects, in the world of the image [†1], that is, not where we adopt a radically different way of speaking.

Page 82

50 If memory is *no* kind of seeing into the past, how do we know at all that it is to be taken as referring to the past? We could then remember some incident and be in doubt whether in our memory image we have a picture of the past or of the future.

Page 82

We can of course say: I do not see the past, only a *picture* of the past. But how do I know it's a picture of the *past* unless this belongs to the essence of a memory-image? Have we, say, learnt from experience to interpret these pictures as pictures of the past? But in this context what meaning would 'past' have at all?

Page 82

Yet it contradicts every concept of physical time that I should have perception into the past, and that again seems to mean nothing

Page Break 83

else than that the concept of time in the first system must be radically different from that in physics.

Page 83

Can I conceive the time in which the experiences of visual space occur without experiences of sound? It appears so. And yet how strange that something should be able to have a form, which would also be conceivable without *this* content. Or does a man who has been given hearing also learn a new time along with it?

Page 83

The traditional questions are not suited to a logical investigation of phenomena. These generate their own questions, or rather, give their own answers.

Page 83

51 If I compare the facts of immediate experience with the pictures on the screen and the facts of physics with pictures in the film strip, on the film strip there is a present picture and past and future pictures. But on the screen, there is only the present.

Page 83

What is characteristic about this image is that in using it I regard the future as preformed.

Page 83

There's a point in saying future events are pre-formed if it belongs to the *essence* of time that it does not break off. For then we can say: something will happen, it's only that I don't know what. And in the world of physics we can say that.

Page 83

52 It's strange that in ordinary life we are not troubled by the feeling that the phenomenon is slipping away from us, the constant flux of appearance, but only when we philosophize. This indicates that what is in question here is an idea suggested by a misapplication of our language.

Page 83

The feeling we have is that the present disappears into the past without our being able to prevent it. And here we are obviously using the picture of a film strip remorselessly moving past us, that we are unable to stop. But it is of course just as clear that the picture is misapplied: that we cannot say 'Time flows' if by time we mean the possibility of change. What we are looking at here is really the possibility of motion: and so the logical form of motion.

Page Break 84

Page 84

In this connection it appears to us as if memory were a somewhat secondary sort of experience, when compared with experience of the present. We say 'We can *only* remember that'. As though in a primary sense memory were a somewhat faint and uncertain picture of what we originally had before us in full clarity.

Page 84

In the language of physical objects, that's so: I say: 'I *only* have a *vague* memory of this house.'

53 And why not let matters rest there? For this way of talking surely says everything we want to say, and everything that can be said. But we wish to say that it can also be put *differently*; and that is important.

It is as if the emphasis is placed elsewhere in this other way of speaking: for the words 'seem', 'error', etc., have a certain emotional overtone which doesn't belong to the essence of the phenomena. In a way it's connected with the will and not merely with cognition.

We talk for instance of an optical illusion and associate this expression with the idea of a mistake, although of course it isn't essential that there should be any mistake; and if appearance were normally more important in our lives than the results of measurement, then language would also show a different attitude to this phenomenon.

There is not--as I used to believe--a primary language as opposed to our ordinary language, the 'secondary' one. But one could speak of a primary language as opposed to ours in so far as the former would not permit any way of expressing a preference for certain phenomena over others; it would have to be, so to speak, absolutely *impartial*.

54 What belongs to the essence of the world cannot be expressed by language.

For this reason, it cannot *say* that everything flows. Language can only say those things that we can also imagine otherwise.

That everything flows must be expressed in the application of language, and in fact not in one kind of application as opposed to another but in *the* application. In anything we would ever call the application of language.

By application I understand what makes the combination of sounds or marks into a language at all. In the sense that it is the application which makes the rod with marks on it into a *measuring rod* [†1]: *putting language up against* reality.

We are tempted to say: only the experience of the present moment has reality. And then the first reply must be: As opposed to what?

Does it imply I didn't get up this morning? (For if so, it would be dubious.) But that is not what we mean. Does it mean that an event that I'm not remembering at this instant didn't occur? Not that either.

The proposition that only the present experience has reality appears to contain the last consequence of solipsism. And in a sense that is so; only what it is able to say amounts to just as little as can be said by solipsism.--For what belongs to the essence of the world simply *cannot* be said. And philosophy, if it were to say anything, would have to describe the essence of the world.

But the essence of language is a picture of the essence of the world; and philosophy as custodian of grammar can in fact grasp the essence of the world, only not in the propositions of language, but in rules for this language which exclude nonsensical combinations of signs.

If someone says, only the *present experience* has reality, then the word 'present' must be redundant here, as the word 'I' is in other contexts. For it cannot mean *present* as opposed to past and future.--Something else must be meant by the word, something that isn't *in* a space, but is itself a space. That is to say, not something bordering on something else (from which it could therefore be limited off). And so, something language cannot legitimately set in relief.

The present we are talking about here is not the frame in the film reel that is in front of the projector's lens at precisely this moment, as opposed to the frames before and after it, which have already been there or are yet to

come; but the picture on the screen which would illegitimately be called present, since 'present' would not be used here to distinguish it from past and future. And so it is a meaningless epithet.

Page 86

55 There are, admittedly, very interesting, completely general propositions of great importance, therefore propositions describing an actual experience which might have been otherwise, but just *is as it is*. For instance, that I have only *one* body. That my sensations never reach out beyond this body (except in cases where someone has had a limb, e.g. an arm, amputated, and yet feels pain in his fingers). These are remarkable and interesting facts.

Page 86

But it does *not* belong in this category, if someone says I cannot remember the future. For that means nothing, and, like its opposite, is something inconceivable.

Page 86

That I always see with my *eyes* when I am awake is on the other hand a remarkable and interesting fact. Equally, it is important that my visual field is almost incessantly in a state of flux.

Page 86

'I' clearly refers to my body, for *I* am in this room; and 'I' is essentially something that is in a place, and in a place belonging to the same space as the one the other bodies are in too.

Page 86

From the very outset 'Realism', 'Idealism', etc., are names which belong to metaphysics. That is, they indicate that their adherents believe they can say something specific about the essence of the world.

Page 86

56 Anyone wishing to contest the proposition that only the present experience is real (which is just as wrong as to maintain it) will perhaps ask whether then a proposition like 'Julius Caesar crossed the Alps' merely describes my present mental state which is occupied with the matter. And of course the answer is: no, it

Page Break 87

describes an event which we believe happened ca. 2,000 years ago. That is, if the word 'describes' is construed in the same way as in the sentence 'The proposition "I am writing" *describes* what I am at present doing'. The name Julius Caesar designates a person. But what does all that amount to? I seem to be fighting shy of the genuinely philosophical answer! Propositions dealing with people, i.e. containing proper names, can be verified in very different ways.--We still might find Caesar's corpse: that this is thinkable is directly connected with the sense of the proposition about Caesar. But also that a manuscript might be found from which it emerged that such a man never lived and that the accounts of his existence were concocted for particular purposes. Propositions about Julius Caesar must, therefore, have a sense of a sort that covers this possibility. If I utter the proposition: I can see a red patch crossing a green one, the possibilities provided for in 'Julius Caesar crossed the Alps' are not present here, and to that extent I can say that the proposition about Caesar has its sense in a more indirect way than this one.

Page 87

Everything which, if it occurred, would legitimately confirm a belief, determines logically the nature of this belief. That is, it shows something about the logical nature of the belief.

Page 87

The proposition about Julius Caesar is simply a framework (like that about any other person) that admits of widely differing verifications, although not all those it would allow in speaking of other people--of living people, for instance.

Page 87

Isn't all that I mean: between the proposition and its verification there is no go-between negotiating this verification?

Page 87

Even our ordinary language has of course to provide for all cases of uncertainty, and if we have any philosophical objection to it, this can only be because in certain cases it gives rise to misinterpretations.

Page Break 88

VI

Page 88

57 One of the most misleading representational techniques in our language is the use of the word 'I', particularly when it is used in representing immediate experience, as in 'I can see a red patch'.

Page 88

It would be instructive to replace this way of speaking by another in which immediate experience would be represented without using the personal pronoun; for then we'd be able to see that the previous representation wasn't

essential to the facts. Not that the representation would be in any sense more correct than the old one, but it would serve to show clearly what was logically essential in the representation.

Page 88

The worst philosophical errors always arise when we try to apply our ordinary--physical--language in the area of the immediately given.

Page 88

If, for instance, you ask, 'Does the box still exist when I'm not looking at it?', the only right answer would be 'Of course, unless someone has taken it away or destroyed it'. Naturally, a philosopher would be dissatisfied with this answer, but it would quite rightly reduce his way of formulating the question *ad absurdum*.

Page 88

All our forms of speech are taken from ordinary, physical language and cannot be used in epistemology or phenomenology without casting a distorting light on their objects.

Page 88

The very expression 'I can perceive x ' is itself taken from the idioms of physics, and x ought to be a physical object--e.g. a body--here. Things have already gone wrong if this expression is used in phenomenology, where x must refer to a datum. For then 'I' and 'perceive' also cannot have their previous senses.

Page 88

58 We could adopt the following way of representing matters: if I, L. W., have toothache, then that is expressed by means of the proposition 'There is toothache'. But if that is so, what we now

Page Break 89

express by the proposition 'A has toothache', is put as follows: 'A is behaving as L. W. does when there is toothache'. Similarly we shall say 'It is thinking' [†1] and 'A is behaving as L. W. does when it is thinking'. (You could imagine a despotic oriental state where the language is formed with the despot as its centre and his name instead of L. W.) It's evident that this way of speaking is equivalent to ours when it comes to questions of intelligibility and freedom from ambiguity. But it's equally clear that this language could have anyone at all as its centre.

Page 89

Now, among all the languages with different people as their centres, each of which I can understand, the one with me as its centre has a privileged status. This language is particularly adequate. How am I to express that? That is, how can I rightly represent its special advantage in words? This can't be done. For, if I do it in the language with me as its centre, then the exceptional status of the description of this language in its own terms is nothing very remarkable, and in the terms of another language my language occupies no privileged status whatever.--The privileged status lies in the application, and if I describe this application, the privileged status again doesn't find expression, since the description depends on the language in which it's couched. And now, which description gives just that which I have in mind depends again on the application.

Page 89

Only their application really differentiates languages; but if we disregard this, all languages are equivalent. All these languages only describe one single, incomparable thing and *cannot* represent anything else. (Both these approaches must lead to the same result: first, that what is represented is not one thing among others, that it is not capable of being contrasted with anything; second, that I cannot express the advantage of *my* language.)

Page 89

59 It isn't possible to believe something for which you cannot imagine some kind of verification.

Page 89

If I say I believe that someone is sad, it's as though I am seeing his behaviour through the medium of sadness, from the viewpoint

Page Break 90

of sadness. But could you say: 'It looks to me as if I'm sad, my head is drooping so'?

Page 90

60 Not only does epistemology pay no attention to the truth or falsity of genuine propositions, it's even a philosophical method of focusing on precisely those propositions whose content seems to us as physically impossible as can be imagined (e.g. that someone has an ache in someone else's tooth). In this way, epistemology highlights the fact that its domain includes everything that can possibly be thought.

Page 90

Does it make *sense* to say that two people have the same body? That is an uncommonly important and

interesting question. If it makes no sense, then that means--I believe--that only our bodies are the principle of individuation. It is clearly imaginable that I should feel a pain in the hand of a different body from the one called my own. But suppose now that my old body were to become completely insensible and inert and from then on I only felt my pains in the other body?

Page 90

You could say: Philosophy is constantly gathering a store of propositions without worrying about their truth or falsity; only in the cases of logic and mathematics does it have to do exclusively with the 'true' propositions.

Page 90

61 In the sense of the phrase 'sense data' in which it is inconceivable that someone else should have them, it cannot, for this very reason, be said that someone else does not have them. And by the same token, it's senseless to say that *I*, as opposed to someone else, *have* them.

Page 90

We say, 'I *cannot* feel your toothache'; when we say this, do we only mean that so far we have never as a matter of fact felt someone else's toothache? Isn't it, rather, that it's logically impossible?

Page Break 91

Page 91

What distinguishes *his* toothache from *mine*? If the word 'toothache' means the same in 'I have toothache' and 'He has toothache', what does it then mean to say he can't have the same toothache as I do? How are toothaches to be distinguished from one another? By intensity and similar characteristics, and by location. But suppose these are the same in the two cases? But if it is objected that the distinction is simply that in the one case *I* have it, in the other *he*; then the owner is a defining mark of the toothache itself; but then what does the proposition 'I have toothache' (or someone else does) assert? Nothing at all.

Page 91

If the word 'toothache' has the same meaning in both cases, then we must be able to compare the toothaches of the two people; and if their intensities, etc. coincide, they're the same. Just as two suits have the *same* colour, if they match one another in brightness, saturation, etc.

Page 91

Equally, it's nonsense to say two people can't have the same sense datum, if by 'sense datum' what is *primary* is really intended.

Page 91

62 In explaining the proposition 'He has toothache', we even say something like: 'Quite simple, I know what it means for *me* to have toothache, and when I say he has toothache, I mean he now has what I once had.' But what does 'he' mean and what does '*have* toothache' mean? Is this a relation toothache once had to me and now has to him? So in that case I would also be conscious of toothache now and of his having it now, just as I can now see a wallet in his hand that I saw earlier in mine.

Page 91

Is there a sense in saying 'I have a pain, only I don't notice it'? For I could certainly substitute 'he has' for 'I have' in this proposition. And conversely, if the propositions 'He has a pain' and 'I have a pain' are logically on a par, I must be able to substitute 'I have' for 'he has' in the proposition 'He has a pain that I can't feel'.--I might also put it like this: only in so far as I can have a pain I don't

Page Break 92

feel can he have a pain I don't feel. Then it might still be the case that in fact I always feel the pain I have, but it must make sense to deny that I do.

Page 92

'I have no pain' means: if I compare the proposition 'I have a pain' with reality, it turns out false--so I must be in a position to compare the proposition with what is in fact the case. And the possibility of such a comparison--even though the result may be negative--is what we mean when we say: what is the case must happen in the same space as what is denied; only it must be *otherwise*.

Page 92

63 Admittedly the concept of toothache as a datum of feeling can be applied to someone else's tooth just as readily as it can to mine, but only in the sense that it might well be perfectly possible to feel pain in a tooth in someone else's mouth. According to our present way of speaking we wouldn't, however, express this fact in the words 'I feel his toothache' but by saying 'I've got a pain in his tooth'. Now we may say: Of course you haven't got his toothache, for it is now more than possible that he will say, 'I don't feel anything in this tooth'. And in such a situation, am I supposed to say 'You're lying, I can feel how your tooth is aching'?

When I feel sorry for someone with toothache, I put myself in his place. But I put *myself* in his place.

The question is, whether it makes sense to say: 'Only A can verify the proposition "A is in pain", I can't'. But what would it be like if this were false, and *I* could verify it: can that mean anything other than that I'd have to feel pain? But would that be a verification? Let's not forget: it's nonsense to say *I* must feel *my* or *his* pain.

We might also put the question like this: What in my experience justifies the 'my' in 'I feel *my* pain'? Where is the multiplicity in the feeling that justifies this word? And it can only be justified if we could also replace it by another word.

64 'I have a pain' is a sign of a completely different kind when I am using the proposition, from what it is to me on the lips of another; the reason being that it is senseless, as far as I'm concerned, on the lips of another until I know through which mouth it was expressed. The propositional sign in this case doesn't consist in the sound alone, but in the fact that the sound came out of this mouth. Whereas in the case in which I say or think it, the sign is the sound itself.

Suppose I had stabbing pains in my right knee and my right leg jerked with every pang. At the same time I see someone else whose leg is jerking like mine and he complains of stabbing pains; and while this is going on my left leg begins jerking like the right although I can't feel any pain in my left knee. Now I say: the other fellow obviously has the same pains in his knee as I've got in my right knee. But what about my left knee, isn't it precisely the same case here as that of the other's knee?

If I say 'A has toothache', I use the image of feeling pain in the same way as, say, the concept of flowing when I talk of an electric current flowing.

The two hypotheses that other people have toothache and that they behave just as I do but don't have toothache, possibly have identical senses. That is, if I had, for example, learnt the second form of expression, I would talk in a pitying tone of voice about people who don't have toothache, but are behaving as I do when I have.

Can I imagine pains in the tips of my nails, or in my hair? Isn't that just as possible or impossible as it is to imagine a pain in any part of the body whatever in which I have none at the moment, and cannot remember having had any?

65 The logic of our language is so difficult to grasp at this point: our language employs the phrases 'my pain' and 'his pain', and also the expressions 'I have (or feel) a pain' and 'He has (or feels) a pain'. An expression 'I feel my pain' or 'I feel his pain' is nonsense. And it seems to me that, at bottom, the entire controversy over behaviourism turns on this.

The experience of feeling pain is not that a person 'I' has something.

I distinguish an intensity, a location, etc. in the pain, but not an owner.

What sort of a thing would a pain be that no one *has*? Pain belonging to no one at all?

Pain is represented as something we can perceive in the sense in which we perceive a matchbox. What is unpleasant is then naturally not the pain, only perceiving it.

When I am sorry for someone else because he's in pain, I do of course imagine the pain, but I imagine that *I* have it.

Is it also to be possible for me to imagine the pain of a tooth lying on the table, or a teapot's pain? Are we perhaps to say: it merely isn't true that the teapot is in pain, but I can imagine it being so?!

The two hypotheses, that others have pain, and that they don't and merely behave as I do when I have, must have identical senses if every *possible* experience confirming the one confirms the other

as well. In other words, if a decision between them on the basis of experience is inconceivable.

To say that others have no pain, presupposes that it makes sense to say they do have pains.

I believe it's clear we say other people have pains in the same sense as we say a chair has none.

66 What would it be like if I had two bodies, i.e. my body were composed of two separate organisms?

Here again, I think, we see the way in which the self is not on a par with others, for if everyone else had two bodies, I wouldn't be able to tell that this was so.

Can I imagine experience with two bodies? Certainly not visual experience.

The phenomenon of feeling toothache I am familiar with is represented in the idioms of ordinary language by 'I have a pain in such-and-such a tooth'. Not by an expression of the kind 'In this place there is a feeling of pain'. The *whole* field of this experience is described in this language by expressions of the form 'I have...'. Propositions of the form 'N has toothache' are reserved for a totally different field. So we shouldn't be surprised when for propositions of the form 'N has toothache', there is nothing left that links with experience in the same way as in the first case.

Philosophers who believe you can, in a manner of speaking, extend experience by thinking, ought to remember that you can transmit speech over the telephone, but not measles.

Similarly I cannot at will experience time as bounded, or the visual field as homogeneous, etc.

Visual space and retina. It's as if you were to project a sphere orthogonally on to a plane, for instance in the way in which you represent the two hemispheres of the globe in an atlas, and now someone might believe that what's on the page surrounding the two projections of the sphere somehow still corresponds to a possible extension of what is to be found on the sphere. The point is that here a *complete space* is projected onto a *part* of another space; and it is like this with the limits of language in a dictionary.

If someone believes he can imagine four-dimensional space, then why not also four-dimensional colours--colours which in addition to the degree of saturation, hue and intensity of light, are susceptible of being determined in yet a fourth way.

VII

67 Suppose I had such a good memory that I could remember all my sense impressions. In that case, there would, *prima facie*, be nothing to prevent me from describing them. This would be a biography. And why shouldn't I be able to leave everything hypothetical out of this description?

I could, e.g., represent the visual images plastically, perhaps with plaster-cast figures on a reduced scale which I would only finish as far as I had actually seen them, designating the rest as inessential by shading or some other means.

So far everything would be fine. But what about the time I take to make this representation? I'm assuming I'd be able to keep pace with my memory in 'writing' this language--producing this representation. But if we suppose I then read the description through, isn't it now hypothetical after all?

Let's imagine a representation such as this: the bodies I seem to see are moved by a mechanism in such a

way that they would give the visual images to be represented to two eyes fixed at a particular place in the model. The visual image described is then determined from the position of the eyes in the model and from the position and motion of the bodies.

Page 97

We could imagine that the mechanism could be driven by turning a crank and in that way the description 'read off'.

Page 97

68 Isn't it clear that this would be the most immediate description we can possibly imagine? That is to say, that anything which tried to be more immediate still would inevitably cease to be a description.

Page 97

Instead of a description, what would then come out would be

Page Break 98

that inarticulate sound with which many writers would like to begin philosophy. ('I have, knowing of my knowledge, consciousness of something.')

Page 98

You simply can't begin before the beginning.

Page 98

Language itself belongs to the second system. If I describe a language, I am essentially describing something that belongs to physics. But how can a physical language describe the phenomenal?

Page 98

69 Isn't it like this: a phenomenon (specious present) contains time, but isn't in time?

Page 98

Its form is time, but it has no place in time.

Page 98

Whereas language unwinds in time.

Page 98

What we understand by the word 'language' unwinds in physical time. (As is made perfectly clear by the comparison with a mechanism.)

Page 98

Only what corresponds to this mechanism in the primary world could be the primary language.

Page 98

I mean: what I call a sign must be what is called a sign in grammar; something on the film, not on the screen.

Page 98

'I cannot tell whether...' only makes sense if I *can* know, not when it's inconceivable.

Page 98

70 With our language we find ourselves, so to speak, in the domain of the film, not of the projected picture. And if I want to make music to accompany what is happening on the screen, whatever produces the music must again happen in the sphere of the film.

Page 98

On the other hand, it's clear we need a way of speaking with which we can represent the phenomena of visual space, isolated as such.

Page 98

'I can see a lamp standing on the table', says, in the way in which it has to be understood in our ordinary language, more than a

Page Break 99

description of visual space. 'It seems to me as if I were seeing a lamp standing on a table' would certainly be a correct description: but this form of words is misleading since it makes it look as though nothing actual were being described, but only something whose nature was unclear.

Page 99

Whereas 'it seems' is only meant to say that something is being described as a special case of a general rule, and all that is uncertain is whether further events will be capable of being described as special cases of the same rule.

Page 99

It seems as if there is a sine curve on the film, of which we can see particular parts.

Page 99

That is to say, what we see can be described by means of a sine curve on the film, when the light projecting it

has been interrupted at particular points.

Page 99

A concentric circle seems to have been drawn round the circle K and a, b, c, d, e, f to have been drawn as tangents to it.

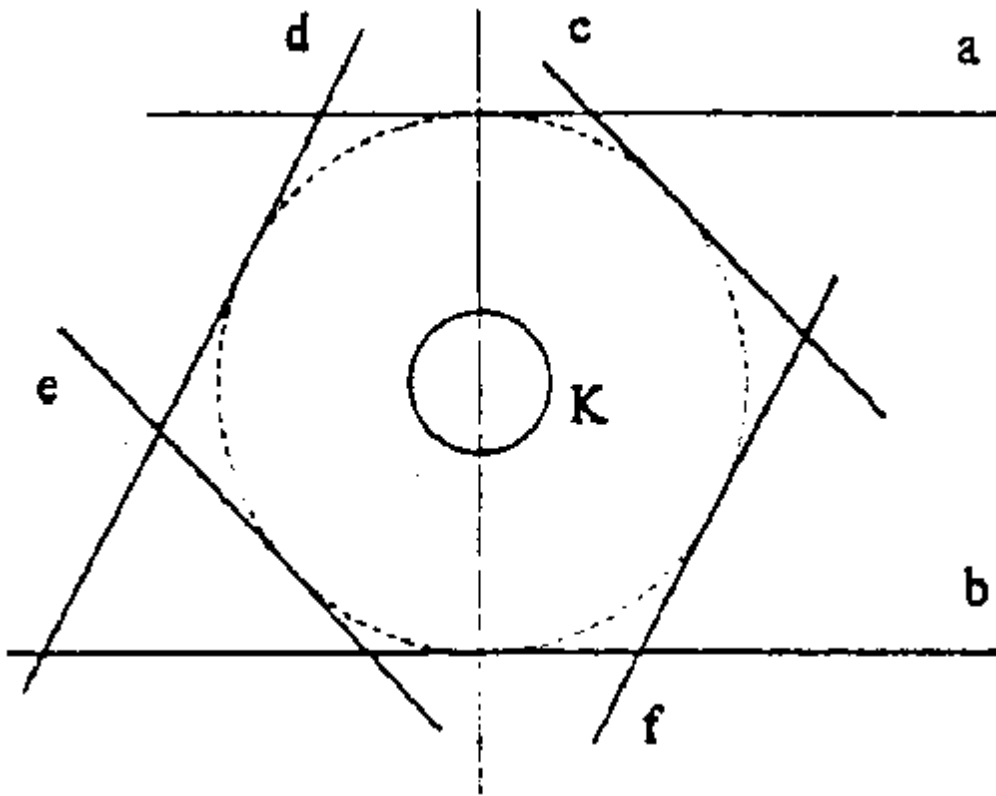

Page 99

71 It could, e.g., be practical under certain circumstances to give proper names to my hands and to those of other people, so that you

Page Break 100

wouldn't have to mention their relation to somebody when talking about them, since that relation isn't essential to the hands themselves; and the usual way of speaking could create the impression that its relation to its owner was something belonging to the essence of the hand itself.

Page 100

Visual space has essentially no owner.

Page 100

Let's assume that, with all the others, I can always see one particular object in visual space--viz my nose--. Someone else naturally doesn't see this object in the same way. Doesn't that mean, then, that the visual space I'm talking about *belongs to me*? And so is subjective? No. It has only been construed subjectively here, and an objective space opposed to it, which is, however, only a construction with visual space as its basis. In the--secondary--language of 'objective'--physical--space, visual space is called subjective, or rather, whatever in this language corresponds directly with visual space is called subjective. In the same way that one might say that in the language of real numbers whatever in their domain corresponds directly with the cardinal numbers is called the 'positive integers'.

Page 100

In the model described above neither the two eyes that see the objects, nor their position need be included. That's only *one* technique of representation. It does just as well if e.g. the part of the objects that is 'seen', is indicated by shading it in. Of course you can always work out the position of two eyes from the boundaries of this shaded area; but that only corresponds to translation from one way of speaking into another.

Page 100

The essential thing is that the representation of visual space is the representation of an object and contains no suggestion of a subject.

Page 100

72 Suppose all the parts of my body could be removed until only one eyeball was left; and this were to be firmly

fixed in a certain position, retaining its power of sight. How would the world appear to me? I wouldn't be able to perceive any part of myself,

Page Break 101

and supposing my eyeball to be transparent for me, I wouldn't be able to see myself in the mirror either. One question arising at this point is: would I be able to locate myself by means of my visual field? 'Locate myself', of course here only means to establish a particular structure for the visual space.

Page 101

Does anything now force me into interpreting the tree I see through my window as larger than the window? If I have a sense for the distance of objects from my eye, this is a justified interpretation. But even then it's a representation in a different space from visual space, for what corresponds to the tree in visual space is, surely, obviously smaller than what corresponds to the window.

Page 101

Or ought I to say: Well, that all depends on how you're using the words 'larger' and 'smaller'?

Page 101

And that's right: in visual space I can use the words 'larger' and 'smaller' both ways. And in one sense the visual mountain is smaller, and in the other larger, than the visual window.

Page 101

Suppose my eyeball were fixed behind the window, so that I would see most things through it. In that case this window could assume the role of a part of my body. What's near the window is near me. (I'm assuming I can see three-dimensionally with one eye.) In addition, I assume that I'm in a position to see my eyeball in the mirror, and perceive similar eyeballs on the trees outside, say.

Page 101

How can I in this case tell, or arrive at the assumption, that I see the world through the pupil of my eyeball? Surely not in an essentially different way from that of my seeing it through the window, or, say, through a hole in a board that my eye is directly behind.

Page 101

In fact, if my eye were in the open stuck on the end of a branch, my position could be made perfectly clear to me by someone bringing a ring closer and closer until in the end I could see

Page Break 102

everything through it. They could even bring up the old surroundings of my eye: cheek bones, nose, etc., and I would know where it all fits in.

Page 102

73 Does all this mean then that a visual image does essentially contain or presuppose a subject after all?

Page 102

Or isn't it rather that these experiments give me nothing but purely geometrical information?

Page 102

That is to say information that constantly only concerns the object.

Page 102

Objective information about reality.

Page 102

There isn't an eye belonging to me and eyes belonging to others in visual space. Only the space itself is asymmetrical, the objects in it are on a par. In the space of physics however this presents itself in such a way that one of the eyes which are on a par is singled out and called *my* eye.

Page 102

I want to know what's going on behind me and turn round. If I were prevented from doing this, wouldn't the idea that space stretches out around me remain? And that I could manage to see the objects now behind me by turning around. *Therefore* it's the possibility of turning around that leads me to this idea of space. The resulting space around me is thus a mixture of visual space and *the space of muscular sensation*.

Page 102

Without the feeling of the ability 'to turn around', my idea of space would be *essentially* different.

Page 102

Thus the detached, immovable eye wouldn't have the idea of a space all around it.

Page 102

74 Immediate experience cannot contain any contradiction. If it is beyond all speaking and contradicting, then the demand for an explanation cannot arise either: the feeling that there must be an explanation of what is happening,

since otherwise something would be amiss.

Page Break 103

Page 103

What about when we close our eyes: we don't stop seeing. But what we see in this case surely can't have any relation to an eye. And it's the same with a dream image. But even in the case of normal seeing, it's clear that the exceptional position of my body in visual space only derives from other feelings that are located in my body, and not from something purely visual.

Page 103

Even the word 'visual space' is unsuitable for our purpose, since it contains an allusion to a sense organ which is as inessential to the space as it is to a book that it belongs to a particular person; and it could be very misleading if our language were constructed in such a way that we couldn't use it to designate a book without relating it to an owner. It might lead to the idea that a book can only exist in relation to a person.

Page 103

75 If, now, phenomenological language isolates visual space and what goes on in it from everything else, how does it treat time? Is the time of 'visual' phenomena the time of our ordinary idioms of physics?

Page 103

It's clear we're able to recognize that two time intervals are equal. I could, e.g., imagine what happens in visual space being accompanied by the ticking of a metronome or a light flashing at regular intervals.

Page 103

To simplify matters, I'm imagining the changes in my visual space to be discontinuous, and, say, in time with the beats of the metronome. Then I can give a description of these changes (in which I use numbers to designate the beats).

Page 103

Suppose this description to be a prediction, which is now to be verified. Perhaps I know it by heart and now compare it with what actually happens. Everything hypothetical is avoided here, apart from what is contained in the presupposition that the description is given to me independently of the question of which elements in it are before me at precisely this moment.

Page Break 104

Page 104

The whole is a talking film, and the spoken word that goes with the events on the screen is just as fleeting as those events and not the same as the sound track. The sound track doesn't accompany the scenes on the screen.

Page 104

Does it now make any sense to say I could have been deceived by a demon and what I took for a description wasn't one at all, but a memory delusion? No, that can have no sense. A delusion that, *ex hypothesi*, cannot be unmasked isn't a delusion.

Page 104

And this means no more and no less than that the time of my memory is, in this instance, precisely the time which I'm describing.

Page 104

This isn't the same as time as it's usually understood: for that, there are any number of possible sources, such as the accounts other people give, etc. But here it is once again a matter of isolating the one time.

Page 104

If there are three pipes in which a black liquid, a yellow liquid and a red liquid are flowing respectively, and these combine at some point to make a brown, then the resulting liquid has its own way of flowing too; but all I want to say is that each of the liquids with a simple colour also has a way of flowing, and I wish to examine this at a point before the three have run into one another.

Page 104

Of course the word 'present' is also out of place here. For to what extent can we say of reality that it is present? Surely only if we embed it once more in a time that is foreign to it. In itself it isn't present. Rather, on the contrary, it contains a time.

Page Break 105

Page 105

76 One's first thought is that it's incompatible for two colours to be in *one* place at the same time. The next is that

two colours in one place simply combine to make another. But third comes the objection: how about the complementary colours? What do red and green make? Black perhaps? But do I then see green in the black colour?--But even apart from that: how about the mixed colours, e.g. mixtures of red and blue? These contain a greater or lesser element of red: what does that mean? It's clear what it means to say that something *is red*: but that it *contains* more or less red?--And different degrees of red are incompatible with one another. Someone might perhaps imagine this being explained by supposing that certain small quantities of red added together would yield a specified degree of red. But in that case what does it mean if we say, for example, that five of these quantities of red are present? It cannot, of course, be a logical product of quantity no. 1 being present, and quantity no. 2 etc., up to 5; for how would these be distinguished from one another? Thus the proposition that 5 degrees of red are present can't be analysed like this. Neither can I have a concluding proposition that this is all the red that is present in this colour: for there is no sense in saying that no more red is needed, since I can't add quantities of red with the 'and' of logic.

Page 105

Neither does it mean anything to say that a rod which is 3 yards long is 2 yards long, because it is $2 + 1$ yards long, since we can't say it is 2 yards long and that it is 1 yard long. The length of 3 yards is something new.

Page 105

And yet I can say, when I see two different red-blues: there's an even redder blue than the redder of these two. That is to say, from the given I can construct what is not given.

Page 105

You could say that the colours have an elementary affinity with one another.

Page Break 106

Page 106

That makes it look as if a construction might be possible within the elementary proposition. That is to say, as if there were a construction in logic which didn't work by means of truth functions.

Page 106

What's more, it also seems that these constructions have an effect on one proposition's following logically from another.

Page 106

For, if different degrees exclude one another it follows from the presence of one that the other is not present. In that case, two elementary propositions can contradict one another.

Page 106

77 How is it possible for $f(a)$ and $f(b)$ to contradict one another, as certainly seems to be the case? For instance, if I say 'There is red here now' and 'There is green here now'?

Page 106

This is connected with the idea of a *complete description*: 'The patch is green' describes the patch completely, and there's no room left for another colour.

Page 106

It's no help either that red and green can, in a manner of speaking, pass one another by in the dimension of time: for, suppose I say that throughout a certain period of time a patch was red and that it was green?

Page 106

If I say for example that a patch is simultaneously light red and dark red, I imagine as I say it that the one shade covers the other. But then is there still a sense in saying the patch has the shade that is invisible and covered over?

Page 106

Does it make any sense at all to say that a perfectly black surface is white, only we don't see the white because it is covered by the black? And why does the black cover the white and not vice versa?

Page 106

If a patch has a visible and an invisible colour, then at any rate it has these colours in quite different senses.

Page 106

78 If $f(r)$ and $f(g)$ contradict one another, it is because r and g completely occupy the f and cannot both be in it. But that doesn't show itself in our signs. But it must show itself if we look, not at

Page Break 107

the sign, but at the symbol. For since this includes the form of the objects, then the impossibility of ' $f(r)$ &unk; $f(g)$ ' must show itself there, in this form.

Page 107

It must be possible for the contradiction to show itself entirely in the symbolism, for if I say of a patch that it

is red and green, it is certainly at most only one of these two, and the contradiction must be contained in the *sense* of the two propositions.

Page 107

That two colours won't fit at the same time in the same place must be contained in their form and the form of space.

Page 107

But the symbols do contain the form of colour and of space, and if, say, a letter designates now a colour, now a sound, it's a *different* symbol on the two occasions; and this shows in the fact that different syntactical rules hold for it.

Page 107

Of course, this doesn't mean that inference could now be not only formal, but also material.--Sense follows from sense and so form from form.

Page 107

'Red and green won't both fit into the same place' doesn't mean that they are as a matter of fact never together, but that you can't even say they are together, or, consequently, that they are never together.

Page 107

79 But that would imply that I can write down two particular propositions, but not their logical product.

Page 107

The two propositions collide in the object.

Page 107

The proposition $f(g) \& \text{unk}; f(r)$ isn't nonsense, since not *all* truth possibilities disappear, even if they are all rejected. We can, however, say that the ' \bullet ' has a different meaning here, since ' $x \bullet y$ ' usually means ($TFFF$); here, on the other hand, it means (FFF). And something analogous holds for ' $x \vee y$ ', etc.

Page 107

80 A yellow tinge is not the colour yellow.

Page Break 108

Page 108

Strictly, I cannot *mix* yellow and red, i.e. not strictly see them at the same time, since if I want to see yellow in this place, the red must leave it and vice versa.

Page 108

It's clear, as I've said, that the proposition that a colour contains five tints of yellow cannot say it contains tint no. 1 and it contains tint no. 2 etc. On the contrary the addition of the tints must occur within the elementary proposition. But what if these tints are objects lined up like links in a chain in a certain way; and now in one proposition we are speaking of five such links, and in another proposition of three. All right, but these propositions must exclude one another, while yet not being analysable.--But then do F_5 and F_6 have to exclude each other? Can't I say, F_n doesn't mean that the colour contains *only* n tints, but that it contains *at least* n tints? It contains *only* n tints would be expressed by the proposition $F(n) \bullet \sim F(n + 1)$. But even then the elementary propositions aren't independent of one another, since $F(n - 1)$ at any rate still follows from $F(n)$, and $F(5)$ contradicts $\sim F(4)$.

Page 108

The proposition asserting a certain degree of a property contradicts on the one interpretation the specification of any other degree and on the other interpretation it follows from the specification of any higher degree.

Page 108

A conception which makes use of a product $aR_x \& \text{unk}; xR_y \bullet yR_b$ is inadequate too, since I must be able to distinguish the things x , y , etc., if they are to yield a distance.

Page 108

A mixed colour, or better, a colour intermediate between blue and red is such in virtue of an internal relation to the structures of blue and red. But this internal relation is *elementary*. That is, it doesn't consist in the proposition ' a is blue-red' representing a logical product of ' a is blue' and ' a is red'.

Page 108

To say that a particular colour is now in a place is to describe that place *completely*.

Page 108

81 Besides, the position is no different for colours than for sounds or electrical charges.

Page Break 109

Page 109

In every case it's a question of the complete description of a certain state at *one* point or at the same time.

Wouldn't the following schema be possible: the colour at a point isn't described by allocating *one* number to a point, but by allocating *several* numbers. Only a mixture of such numbers makes the colour; and to describe the colour in full I need the proposition that *this* mixture is the complete mixture, i.e. that nothing more can be added. That would be like describing the taste of a dish by listing its ingredients; then I must add at the end that these are *all* the ingredients.

In this way we could say the colour too is definitely described when all its ingredients have been specified, of course with the addition that these are all there are.

But how is such an addition to be made? If in the form of a *proposition*, then the incomplete description would already have to be one as well. And if not in the form of a proposition, but by some sort of indication in the first proposition, how can I then bring it about that a second proposition of the same form contradicts the first?

Two elementary propositions can't contradict one another.

What about all assertions which appear to be similar, such as: a point mass can only have *one* velocity at a time, there can only be *one* charge at a point of an electrical field, at one point of a warm surface only *one* temperature at one time, at one point in a boiler only *one* pressure etc.? No one can doubt that these are all self-evident and that their denials are contradictions.

82 This is how it is, what I said in the *Tractatus* doesn't exhaust the grammatical rules for 'and', 'not', 'or' etc.; there are rules for the truth functions which also deal with the elementary part of the proposition.

In which case, propositions turn out to be even more like yardsticks than I previously believed.--The fact that *one* measurement is right automatically excludes all others. I say automatically: just as all the graduation marks are on *one* rod, the propositions corresponding to the graduation marks similarly belong together, and we can't measure with one of them without simultaneously measuring with all the others.--It isn't a proposition which I put against reality as a yardstick, it's a *system* of propositions [†1].

We could now lay down the rule that the same yardstick may only be applied once in one proposition. Or that the parts corresponding to different applications of one yardstick should be collated.

'I haven't got stomach-ache' may be compared to the proposition 'These apples cost nothing'. The point is that they don't cost any money, not that they don't cost any snow or any trouble. The zero is the zero point of *one* scale. And since I can't be given any point on the yardstick without being given the yardstick, I can't be given its zero point either. 'I haven't got a pain' doesn't refer to a condition in which there can be no talk of pain, on the contrary we're talking about pain. The proposition presupposes the capacity for feeling pain, and this can't be a 'physiological capacity'--for otherwise how would we know what it was a capacity for--it's a logical possibility.--I describe my present state by alluding to something that isn't the case. If this allusion is needed for the description (and isn't merely an ornament), there must be something in my present state making it necessary to mention (allude to) this. I compare this state with another, it must therefore be comparable with it. It too must be located in pain-space, even if at a different point.--Otherwise my proposition would mean something like: my present state has *nothing to do* with a painful one; rather in the way I might say the colour of this rose has nothing to do with Caesar's conquest

of Gaul. That is, there's no connection between them. But I mean precisely that there is a connection between my present state and a painful one.

I don't describe a state of affairs by mentioning something that has nothing to do with it and stating it has nothing to do with it. That wouldn't be a negative description.

'The sense consists in the possibility of recognition', but this is a logical possibility. I must be in the space in which what is to be expected is located.

83 The concept of an 'elementary proposition' now loses all of its earlier significance.

The rules for 'and', 'or', 'not' etc., which I represented by means of the T-F notation, are *a part* of the grammar of these words, but not *the whole*.

The concept of independent co-ordinates of description: the propositions joined, e.g., by 'and' are not independent of one another, they form *one* picture and can be tested for their compatibility or incompatibility.

In my old conception of an elementary proposition there was no determination of the value of a co-ordinate; although my remark that a coloured body is in a colour-space, etc., should have put me straight on to this.

A co-ordinate of reality may only be determined *once*.

If I wanted to represent the general standpoint I would say: 'You should not say now one thing and now another about the same matter.' Where the matter in question would be the coordinate to which I can give *one* value and no more.

84 The situation is misrepresented if we say we may not ascribe to an object two incompatible attributes. For seen like that, it looks as if in every case we must first investigate whether two determinations are incompatible or not. The truth is, *two* determinations of the same kind (co-ordinate) are impossible.

What we have recognized is simply that we are dealing with yardsticks, and not in some fashion with isolated graduation marks.

In that case every assertion would consist, as it were, in setting a number of scales (yardsticks) and it's *impossible* to set one scale simultaneously at two graduation marks.

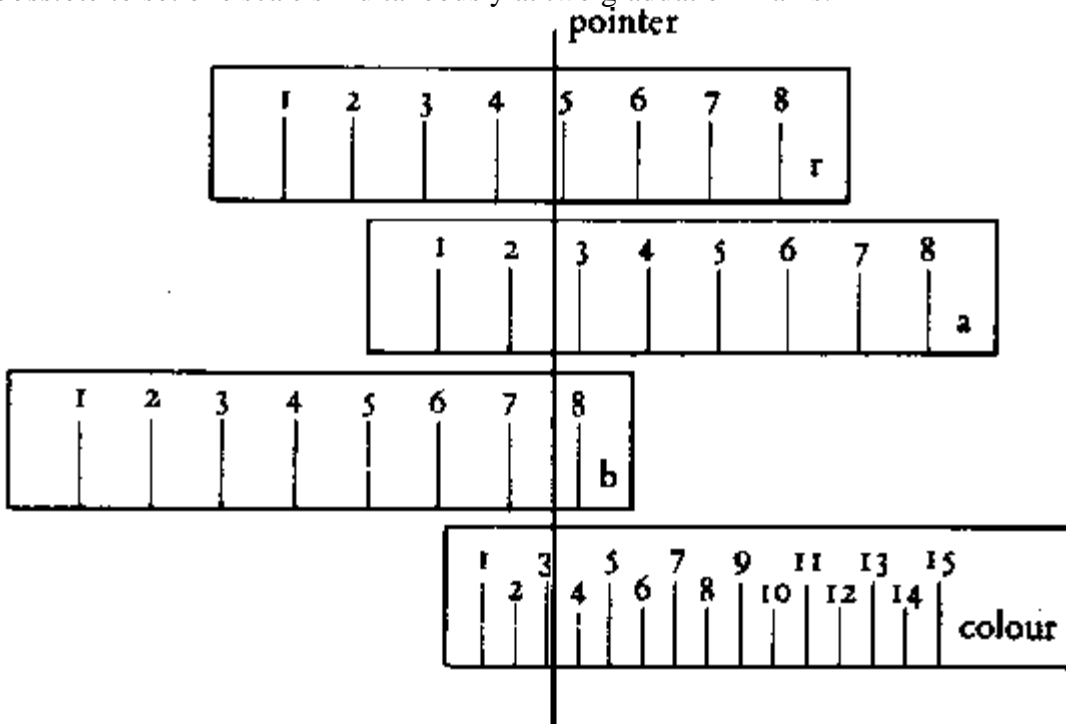

For instance, that would be the claim that a coloured circle, of colour... and radius... was located at.... We might think of signals on a ship: 'Stop', 'Full Speed Ahead', etc.

Incidentally, they don't have to be yardsticks. For you can't call a dial with two signals a yardstick.

85 That every proposition contains time in some way or other appears to us to be accidental, when compared with the fact that the truth-functions can be applied to any proposition.

The latter seems to be connected with their nature as propositions, the former with the nature of the reality we encounter.

True-false, and the truth functions, go with the representation of reality by propositions. If someone said: Very well, how do you know that the whole of reality can be represented by propositions?, the reply is: I only know that it can be represented by propositions in so far as it can be represented by propositions, and to draw a line between a part which can and a part which can't be so represented is something I can't do in language. Language *means* the totality of propositions.

We could say: a proposition is that to which the truth functions may be applied.--The truth functions are essential to *language*.

86 Syntax prohibits a construction such as 'A is green and A is red' (one's first feeling is that it's almost as if this proposition had been done an injustice; as though it had been cheated of its rights as a proposition), but for 'A is green', the proposition 'A is red' is not, so to speak, *another* proposition--and that strictly is what the syntax fixes--but another form of the same proposition.

In this way syntax draws together the propositions that make *one* determination.

If I say I did *not* dream last night, I must still know where I would have to look for a dream (i.e. the proposition 'I dreamt', applied to this situation can at most be false, it cannot be nonsense).

I express the present situation by a setting--the negative one of the signal dial 'dreams--no dreams'. But in spite of its negative setting I must be able to distinguish it from other signal dials. I must know that *this* is the signal dial I have in my hand.

Someone might now ask: Does that imply you have, after all, felt something, so to speak, the hint of a dream, which makes you conscious of the place where a dream would have been? Or if I say 'I haven't got a pain in my arm', does that mean I have a sort of shadowy feeling, indicating the place where the pain would be? No, obviously not.

In what sense does the present, painless, state contain the possibility of pain?

If someone says 'For the word pain to have a meaning, it's necessary that pain should be recognized as such when it occurs', we may reply 'It's no more necessary than that the absence of pain should be recognized as such'.

'Pain' means, so to speak, the whole yardstick and not one of its graduation marks. That it is set at one particular graduation mark can only be expressed by means of a *proposition*.

IX

87 The general proposition 'I see a circle on a red background' appears simply to be a proposition which leaves possibilities open.

A sort of incomplete picture. A portrait in which, e.g. the eyes have not been painted in.

But what would this generality have to do with a totality of objects?

There must be incomplete elementary propositions from whose application the concept of generality derives.

This incomplete picture is, if we compare it with reality, right or wrong: depending on whether or not reality agrees with what can be read off from the picture.

(The theory of probability is connected with the fact that the more general, i.e. the more incomplete, description is more likely to fit the facts than the more complete one.)

Generality in this sense, therefore, enters into the theory of elementary propositions, and not into the theory of truth functions.

88 If I do not completely describe my visual field, but only a part of it, it is obvious that there is, as it were, a gap in the fact. There is obviously something left out.

If I were to paint a picture of this visual image, I would let the canvas show through at certain places. But of course the canvas also has a colour and occupies space. I could not leave *nothing* in the place where something was missing.

My description must therefore necessarily include the whole visual space--and its being coloured, even if it does not specify what the colour is at every place.

That is, it must still say that there is a colour at every place.

Does that mean that the description, in so far as it does not exhaust the space with constants, must exhaust it with variables?

To this one might object that you cannot describe a part of the visual field separated from the whole at all, since it is not even conceivable *on its own*.

But the form (the logical form) of the patch in fact presupposes the whole space. And if you can only describe the whole visual field, then why not only the whole flux of visual experience; for a visual image *can only* exist in time.

89 The question is this: can I leave some determination in a proposition open, *without* at the same time specifying precisely what the possibilities left open are?

Is the case of the general proposition 'A red circle is situated in the square' essentially different from a general assertion of numerical equality, such as 'I have as many jackets as trousers'? and is not this proposition for its part completely on all fours with 'There is *a* number of chairs in this room'? Of course, in everyday life you would not need to develop the disjunction of numbers very far. But however far you go, you must stop somewhere. The question here is always: How do I know such a proposition? Can I ever know it as an endless disjunction?

Even if the first case is construed in such a way that we can establish the position and size of the circle by taking measurements, even then the general proposition cannot be construed as a disjunction (or if so, then just as a finite one). For what then is the criterion for the general proposition, for the circle's being in the square? Either, nothing that has anything to do with a set of positions (or sizes), or else something that deals with a finite number of such positions.

90 Suppose this is my incomplete picture: a red circle stands on a differently coloured background with colour *x*. It is clear that this picture can be used as a proposition in a positive sense, but also in a negative one. In the negative sense it says what Russell expresses as $\sim(\exists x) \phi x$.

Now is there also in my account an analogue to Russell's

$(\exists x) \sim\phi x$? That would mean: there is an *x* of which it is not true that a red circle stands on a background with this colour. Or in other words: there is a colour of the background on which there does not stand a red circle. And in this context that is nonsense!

But how about the proposition 'There is a red ball which is not in the box'? Or 'There is a red circle not in the square'? That is once more a general description of a visual image. Here negation seems to be used in a different way. For it certainly seems as if I could express the proposition 'This circle is not in the square' so that the 'not' is placed *at the front of* the proposition.--But that seems to be an illusion. If you mean by the words 'this circle', 'the circle that I am pointing at', then this case of course falls into line, for then it says 'It is not the case that I am pointing at a circle in the square', but it does not say that I am pointing at a circle outside the square.

Page 117

This is connected with the fact that it's nonsense to give a circle a name. That is to say, I cannot say 'The circle *A* is not in the square'. For that would only make sense if it made sense to say 'The circle *A* is in the square' even when it wasn't.

Page 117

91 If generality no longer combines with truth functions into a homogeneous whole, then a negation cannot occur *within* the scope of a quantifier.

Page 117

Of course I could say: 'There is a red circle outside the square' means 'It is not the case that all red circles are in the square'. But what does 'all' refer to here?

Page 117

'All circles are in the square' can only mean, either 'A certain number of circles are in the square', or 'There is no circle outside'. But the proposition 'There is no circle outside' is once again the negation of a generalization and not the generalization of a negation.

Page Break 118

Page 118

92 If someone confronts us with the fact that language can express everything by means of nouns, adjectives and verbs, we can only say that then it is at any rate necessary to distinguish between entirely different kinds of nouns etc., since different grammatical rules hold for them. This is shown by the fact that it is not permissible to substitute them for one another. This shows that their being nouns is only an external characteristic and that we are in fact dealing with quite different parts of speech. The part of speech is only determined by *all* the grammatical rules which hold for a word, and seen from this point of view our language contains countless different parts of speech.

Page 118

If you give a body a name then you cannot in the same sense give names to its colour, its shape, its position, its surface. And vice versa.

Page 118

'*A*' is the name of a shape, not of a cluster of graphite particles.

Page 118

The different ways names are used correspond exactly to the different uses of the demonstrative pronoun. If I say: 'That is a chair', 'That is the place where it stood', 'That is the colour it had', the word '*that*' is used in that many different ways. (I cannot in the same sense point at a place, a colour, etc.)

Page 118

93 Imagine two planes, with figures on plane *I* that we wish to map on to plane *II* by some method of projection. It is then open to us to fix on a method of projection (such as orthogonal projection) and then to interpret the images on plane *II* according to this method of mapping. But we could also adopt a quite different procedure: we might for some reason lay down that the images on plane *II* should all be circles no matter what the figures on plane *I* may be. That is, different figures on *I* are mapped on to *II* by different methods of projection. In order in this case to construe the circles in *II* as images, I shall have to say for each circle what

Page Break 119

method of projection belongs to it. But the mere fact that a figure is represented on *II* as a circle will say nothing.--It is like this with reality if we map it onto subject-predicate propositions. The fact that we use subject-predicate propositions is only a matter of our notation. The subject-predicate form does not in itself amount to a logical form and is the way of expressing countless fundamentally different logical forms, like the circles on the second plane. The forms of the propositions: 'The plate is round', 'The man is tall', 'The patch is red', have nothing in common.

Page 119

One difficulty in the Fregean theory is the generality of the words 'concept' and 'object'. For even if you can count tables and tones and vibrations and thoughts, it is difficult to bracket them all together.

Page 119

Concept and object: but that is subject and predicate. And we have just said that there is not just one logical

form which is *the* subject-predicate form.

Page 119

94 That is to say, it is clear that once you have started doing arithmetic, you don't bother about functions and objects. Indeed, even if you decide only to deal with extensions, strangely enough you still ignore the form of the objects completely.

Page 119

There is a sense in which an object may not be described.

Page 119

That is, the description may ascribe to it no property whose absence would reduce the existence of the object itself to nothing, i.e. the description may not express what would be essential for the existence of the object.

Page 119

95 I see three circles in certain positions; I close my eyes, open them again and see three circles of the same size in different positions. Does it make sense to ask whether these are the same circles and which is which? Surely not. However, *while* I can see

Page Break 120

them, I can identify them (even if they move before my eyes, I can identify the circles in the new places with those that were in the earlier ones). If I give them names, close my eyes, open them again and see that the circles are in the same places, I can give to each its name once more. (I could still do this even if they had moved so as to exchange places.) In any case, I always name (directly or indirectly) a *location*.

Page 120

Would it be possible to discover a *new* colour? (For the man who is colour-blind is of course in the same position as ourselves, his colours form just as complete a system as ours; he does not see gaps where the remaining colours fit in.) (Comparison with mathematics.)

Page 120

If someone says that substance is indestructible, then what he is really after is that it is senseless in any context to speak of 'the destruction of a substance'--either to affirm or deny it.

Page 120

What characterizes propositions of the form 'This is...' is only the fact that the reality outside the so-called system of signs somehow enters into the symbol.

Page 120

96 Russell and Frege construe a concept as a sort of property of a thing. But it is very unnatural to construe the words 'man', 'tree', 'treatise', 'circle' as properties of a substratum.

Page 120

If a table is painted brown then it's easy to think of the wood as bearer of the property brown, and you can imagine what remains when the colour changes. Even in the case of *one* particular circle which appears now red, now blue. It is thus easy to imagine *what* is red, but difficult to imagine what is circular. What *remains* in this case, if form and colour alter? For position is part of the form, and it is arbitrary for me to lay down that the centre should stay fixed and the only changes in form be changes in the radius.

Page Break 121

Page 121

We must once more adhere to ordinary language and say that a *patch* is circular.

Page 121

It is clear that the phrase 'bearer of a property' in this context conveys a completely wrong--an impossible--picture. If I have a lump of clay, I can consider it as the bearer of a form, and that, roughly, is where this picture comes from.

Page 121

'The patch changes its form' and 'The lump of clay changes its form' are fundamentally different forms of proposition.

Page 121

You can say 'Measure whether *that* is a circle' or 'See whether *that* over there is a hat'. You can also say 'Measure whether *that* is a circle or an ellipse', but not '... whether that is a circle or a hat'; not 'See whether that is a hat or red'.

Page 121

If I point to a curve and say 'That is a circle', then someone can object that if it were not a circle, it would no longer be *that*. That is to say, what I mean by the word 'that' must be independent of what I assert about it.

Page 121

('Was *that* thunder or gunfire?' Here you could not ask 'Was that a noise?')

Page 121

97 Roughly speaking, the equation of a circle is the sign for the concept 'circle', if it does not have definite values substituted for the co-ordinates of its centre and for the radius, or even, if these are only given as lying within a certain range. The object falling under the concept is then a circle whose position and size have been fixed.

Page 121

How are two red circles of the same size distinguished? This question makes it sound as if they were pretty nearly one circle, and only distinguished by a nicety.

Page 121

In the technique of representation by equations, what is common is expressed by the form of the equation and the difference by the difference in the co-ordinates of the centres.

Page 121

So it is as if what corresponds with the objects falling under the concept were here the co-ordinates of the centres.

Page 121

Couldn't you then say, instead of 'This is a circle', 'This point

Page Break 122

is the centre of a circle'? For, to be the centre of a circle is an external property of the point.

Page 122

For the number pair that gives the co-ordinates of the centre is in fact not just anything, any more than the centre is: the number pair characterizes just what in the symbol constitutes the 'difference' of the circles.

Page 122

98 What is necessary to a description that--say--a book is in a certain position? The internal description of the book, i.e. of the concept, and a description of its place which it would be possible to give by giving the co-ordinates of three points. The proposition, 'Such a book is *here*', would then mean that it had *these* three triples of co-ordinates. For the specification of the 'here' must not pre-judge *what* is here.

Page 122

But doesn't it come to the same thing whether I say '*This* is a book' or 'Here is a book'? The proposition would then amount to saying 'Those are three particular corners of such a book'.

Page 122

Similarly you can also say 'This circle is the projection of a sphere' or 'This is a man's appearance'.

Page 122

All that I am saying comes back to this: $F(x)$ must be an *external* description of x .

Page 122

If in this sense I now say in three-dimensional space 'Here is a circle' and on another occasion 'Here is a sphere', are the two 'here's of the same type? Couldn't both refer to the three co-ordinates of the relevant centre-point? But, the position of the circle in three-dimensional space is not fixed by the coordinates of its centre.

Page 122

Suppose my visual field consisted of two red circles of the same size on a blue background: what occurs twice here and what once? And what does this question mean in any case?

Page 122

Here we have *one* colour, but *two* positions.

Page Break 123

X

Page 123

99 We can ask whether numbers are essentially concerned with concepts. I believe this amounts to asking whether it makes sense to ascribe a number to objects that haven't been brought under a concept. For instance, does it mean anything to say '*a* and *b* and *c* are three objects'? I think obviously not. Admittedly we have a feeling: Why talk about concepts; the number, of course, depends only on the *extension* of the concept, and once that has been determined, the concept may drop out of the picture. The concept is only a method for determining an extension, but the extension is autonomous and, in its essence, independent of the concept; for it's quite immaterial which concept we have used to determine the extension. That is the argument for the extensional viewpoint. The immediate objection to it is: if a concept is really only an expedient for arriving at an extension, then there is no place for concepts in arithmetic; in that case we must simply divorce a class completely from the concept which happens

to be associated with it; but if it isn't like that, then an extension independent of a concept is just a chimera, and in that case it's better not to speak of it at all, but only of the concept.

Page 123

How about the proposition ' $(\exists x, y, z) \bullet aRx \bullet xRy \bullet yRz \bullet zRb \vee aRy \bullet yRx \bullet xRz \bullet zRb \vee \text{etc.}$ ' (all combinations)? Can't I write this in the perfectly intelligible form: ' $(\exists 3)_x \bullet aRxRb$ '--say 'Three links are inserted between a and b '? Here we've formed the concept 'link between a and b '.

Page 123

(Things between these walls.)

Page 123

If I have two objects, then I can of course, at least hypothetically, bring them under one umbrella, but what characterizes the extension is still the class, and the concept encompassing it still only a makeshift, a pretext.

Page Break 124

Page 124

100 Numbers are pictures of the extensions of concepts.

Page 124

Now we could regard the extension of a concept as an object, whose name, like any other, has sense only in the context of a proposition. Admittedly, ' a and b and c ' has no sense, it isn't a proposition. But then neither is ' a ' a proposition.

$$(E1)_x \phi x \bullet (E1)_x \psi x \bullet (x) \bullet \sim(\phi x \bullet \psi x). \supset. (E2)_x \phi x. \vee. \psi x$$

Page 124

If ϕ and ψ here are of the form $x = a. \vee. x = b$, etc., then the whole proposition has become a contrivance for ensuring that we add correctly.

Page 124

In the symbolism there is an actual correlation, whereas at the level of meaning only the possibility of correlation is at issue.

Page 124

The problem is: How can we make preparations for the reception of something that may happen to exist?

Page 124

The axiom of infinity is nonsense if only because the possibility of expressing it would presuppose infinitely many things--i.e. what it is trying to assert. You can say of logical concepts such as that of infinity that their essence implies their existence.

Page 124

$$101. (3)_x \phi x \bullet (4)_x \psi x \bullet \sim(\exists x) \phi x. \psi x. \supset_{\phi\psi}. (3 + 4)_x \phi x. \vee. \psi x [\dagger 1]$$

Page 124

This expression isn't equivalent to the substitution rule $3 + 4 = 7$.

Page 124

We might also ask: Suppose I have four objects satisfying a function, does it always make sense to say that these 4 objects are 2 + 2 objects? I certainly don't know whether there are functions grouping them into 2 and 2. Does it make sense to say of 4 objects taken at random that they are composed of 2 objects and 2 objects?

Page Break 125

Page 125

The notation I used above ' $(3 + 4)_x$ ' etc. already contains the assumption that it always makes sense to construe 7 as 3 + 4, since on the right hand side of the ' $\supset_{\phi\psi}$ ' ψ I have so to speak already forgotten where the 3 and 4 have come from. On the other hand: I can surely always distinguish 3 and 4 in the sign $1 + 1 + 1 + 1 + 1 + 1 + 1$.

Page 125

Perhaps this provides the answer? What would it be like for me to have a sign for 7 in which I couldn't separate 3 and 4? Is such a sign conceivable?

Page 125

Does it make sense to say a relation holds between 2 objects, although for the rest there is no concept under which they both fall?

Page 125

102 I want to say numbers can only be defined from propositional *forms*, independently of the question which propositions are true or false.

Page 125

Only 3 of the objects a, b, c, d have the property ϕ . That can be expressed through a disjunction. Obviously another case where a numerical assertion doesn't refer to a concept (although you could make it look as though it did by using an '='.)

Page 125

If I say: If there are 4 apples on the table, then there are $2 + 2$ on it, that only means that the 4 apples already contain the possibility of being grouped into two and two, and I needn't wait for them actually to be grouped by a concept. This 'possibility' refers to the sense, not the truth of a proposition. $2 + 2 = 4$ may mean 'whenever I have four objects, there is the possibility of grouping them into 2 and 2'.

Page 125

103 How am I to know that ||||| and ||||| are the *same* sign? It isn't enough that they look *alike*. For having roughly the same Gestalt can't be what is to constitute the identity of the signs, but just their being the same in number.

Page Break 126

Page 126

If you write (E ||||) etc. • (E |||||) etc. • \supset . (E |||||) --A [\dagger 1] you may be in doubt as to how I obtained the numerical sign in the right-hand bracket if I don't know that it is the result of adding the two left-hand signs. I believe that makes it clear that this expression is only an application of $5 + 7 = 12$ but doesn't represent this equation itself.

Page 126

If we ask: But what then does ' $5 + 7 = 12$ ' mean--what kind of significance or point is left for this expression--the answer is, this equation is a rule for signs which specifies which sign is the result of applying a particular operation (addition) to two other particular signs. The content of $5 + 7 = 12$ (supposing someone didn't know it) is precisely what children find difficult when they are learning this proposition in arithmetic lessons.

Page 126

We can completely disregard the special structure of the proposition A and pay attention solely to the relation, the connection, between the numerical signs in it. This shows that the relation holds independently of the proposition--i.e. of the other features of its structure which make it a tautology.

Page 126

For if I look at it as a tautology I merely perceive features of its structure and can now perceive the addition theorem *in* them, while disregarding other characteristics that are essential to it as a proposition.

Page 126

The addition theorem is in this way to be recognized in it (among other places), not *by means of* it.

Page 126

This thought would of course be nonsense if it were a question here of the *sense* of a proposition, and not of the way the structure of a tautology functions.

Page Break 127

Page 127

104 You could reply: what I perceive in the sign A and call the relation between the numerical signs is once more only the bringing together of extensions of concepts: I combine the first five strokes of the right-hand bracket, which stand in 1-1 correspondence with the five in one of the left-hand brackets, with the remaining 7 strokes, which stand in 1-1 correspondence with the seven in the other left-hand bracket, to make 12 strokes which do one or the other. But even if I followed this train of thought, the fundamental insight would still remain, that the 5 strokes and the 7 combine *precisely to make 12* (and so for example to make the same structure as do 4 and 4 and 4).--It is always only insight into the internal relations of the structures and not some proposition or other or some logical consideration which tells us this. And, as far as this insight is concerned, everything in the tautology apart from the numerical structures is mere decoration; they are all that matters for the arithmetical proposition. (Everything else belongs to the *application* of the arithmetical proposition.)

Page 127

Thus what I want to say is: it isn't what occasions our combining 5 and 7 that belongs to arithmetic, but the process of doing so and its outcome.

Page 127

Suppose I wrote out the proposition A but put the wrong number of strokes in the right-hand bracket, then you would and could only come upon this mistake by comparing the structures, not by applying theorems of logic.

If asked how do you know that this number of strokes in the right-hand bracket is correct, I can only justify it by a comparison of the structures.

In this way it would turn out that what Frege called the 'gingersnap standpoint' in arithmetic could yet have some justification.

105 And now--I believe--the relation between the extensional conception of classes and the concept of a number as a feature of a

logical structure is clear: an extension is a characteristic of the sense of a proposition.

106 Now if the transition in A were the only application of this arithmetical schema, wouldn't it then be possible or necessary to replace it or define it by the tautology?

That is to say, what would it be like for A to be the most general form of the application of the arithmetical schema?

If A were the only--and therefore *essentially* the only--application of the schema, then in the very nature of the case the schema couldn't mean anything other than just the tautology.

Or: the schema itself must then be the tautology and the tautology nothing other than the schema.

In that case, you also could no longer say A was an application of the schema-- A would be the schema, only not as it were the implement on its own, but the implement with its handle, without which it is after all useless.

What A contains apart from the schema can then only be what is necessary in order to apply it.

But nothing at all is necessary, since we understand and apply the propositions of arithmetic perfectly well without adding anything whatever to them.

But forming a tautology is especially out of place here, as we can see perfectly well from the tautology itself, since otherwise in order to recognise it as a tautology we should have to recognise yet another one as a tautology and so on [\dagger 1].

107 Arithmetical propositions, like the multiplication table and things of that kind, or again like definitions which do not have whole propositions standing on both sides, are used in *application* to propositions. And anyhow I certainly can't apply them to anything else. (Therefore I don't first need some description of their application.)

No investigation of concepts, only direct insight can tell us [\dagger 1] that $3 + 2 = 5$.

That is what makes us rebel against the idea that A could be the proposition $3 + 2 = 5$. For what enables us to tell that this expression is a tautology cannot itself be the result of an examination of concepts but must be immediately visible.

And if we say numbers are structures we mean that they must always be of a kind with what we use to represent them.

I mean: numbers are what I represent in my language by number schemata.

That is to say, I take (so to speak) the number schemata of the language as what I know, and say numbers are what these represent [\dagger 2].

This is what I once meant when I said, it is with the calculus [system of calculation] that numbers enter into logic.

Page 129

108 What I said earlier about the nature of arithmetical equations and about an equation's not being replaceable by a tautology explains--I believe--what Kant means when he insists that $7 + 5 = 12$ is not an analytic proposition, but synthetic *a priori*.

Page Break 130

Page 130

Am I using the same numbers when I count the horses in a stall and when I count the different species of animal in the stall? When I count the strokes in a line and the kinds of group (as defined by the different number of strokes)?

Page 130

Whether they are cardinal numbers in the same sense depends on whether the same syntactical rules hold for them.

Page 130

(It is conceivable that there should be no man in a room, but not that there should be a man of *no* race in it.)

Page 130

Arithmetic is the grammar of numbers. Kinds of number can only be distinguished by the arithmetical rules relating to them.

Page 130

109 One always has an aversion to giving arithmetic a foundation by saying something about its application. It appears firmly enough grounded in itself. And that of course derives from the fact that arithmetic is its own application.

Page 130

Arithmetic doesn't talk about numbers, it works with numbers.

Page 130

The calculus presupposes the calculus.

Page 130

Aren't the numbers a logical peculiarity of space and time?

Page 130

The calculus itself exists only in space and time.

Page 130

Every mathematical calculation is an application of itself and only as such does it have a sense. *That* is why it isn't necessary to speak about the general form of logical operation when giving a foundation to arithmetic.

Page 130

A cardinal number is applicable to the subject-predicate form, but not to every variety of this form. And the extent to which it is applicable simply characterizes the subject-predicate form.

Page 130

On the one hand it seems to me that you can develop arithmetic completely autonomously and its application takes care of itself,

Page Break 131

since wherever it's applicable we may also apply it. On the other hand a nebulous introduction of the concept of number by means of the general form of operation--such as I gave--can't be what's needed.

Page 131

You could say arithmetic is a kind of geometry; i.e. what in geometry are constructions on paper, in arithmetic are calculations (on paper).--You could say it is a more general kind of geometry.

Page 131

And can't I say that in this sense chess (or any other game) is also a kind of geometry.

Page 131

But in that case it must be possible to work out an *application* of chess that is completely analogous to that of arithmetic.

Page 131

You could say: Why bother to limit the application of arithmetic, that takes care of itself. (I can make a knife without bothering which sorts of material it will cut: that will show soon enough.)

What speaks against our demarcating a region of application is the feeling that we can understand arithmetic without having any such region in mind. Or put it like this: instinct rebels against anything that isn't restricted to an analysis of the thoughts already before us.

$$\underbrace{2+3}_{5} + 4 = \underbrace{2+4}_{6} + 3 = \underbrace{4+3}_{7} + 2$$

'Look, it always turns out the same.' Seen like that, we have performed an experiment. We have applied the rules of one-and-one and from those you can't tell straight off that they lead to the same result in the three cases.

It's as if we're surprised that the numerals cut adrift from their definitions function so unerringly. Or rather: that the rules for the numerals work so unerringly (when they are not under the supervision of the definitions).

This is connected (oddly enough) with the internal consistency of geometry.

For, you can say the rules for the numerals always presuppose the definitions. But in what sense? What does it mean to say one sign presupposes another that strictly speaking isn't there at all? It presupposes its possibility; its possibility in sign-space (in grammatical space).

It's always a question of whether and how it's possible to represent the most general form of the application of arithmetic. And here the strange thing is that in a certain sense it doesn't seem to be needed. And if in fact it isn't needed then it's also impossible.

The general form of its application seems to be represented by the fact that *nothing* is said about it. (And if that's a possible representation, then it is also *the* right one.)

What is characteristic of a statement of number is that you may replace one number by any other and the proposition must always still be significant; and so the infinite formal series of propositions.

111 The point of the remark that arithmetic is a kind of geometry is simply that arithmetical constructions are autonomous like geometrical ones, and hence so to speak themselves guarantee their applicability.

For it must be possible to say of geometry, too, that it is its own application.



That is an arithmetical construction, and in a *somewhat* extended sense also a geometrical one.

Suppose I wish to use this calculation to solve the following problem: if I have 11 apples and want to share them among some people in such a way that each is given 3 apples, how many people

can there be? The calculation supplies me with the answer 3. Now, suppose I were to go through the whole process of sharing and at the end 4 people each had 3 apples in their hands. Would I then say that the computation gave a

wrong result? Of course not. And that of course means only that the computation was not an experiment.

Page 133

It might look as though the mathematical computation entitled us to make a prediction--say, that I could give 3 people their share and there will be two apples left over. But that isn't so. What justifies us in making this prediction is an hypothesis of physics, which lies outside the calculation. The calculation is only a study of logical forms, of structures, and of itself can't yield anything new.

Page 133

112 Different as strokes and court cases are, you can still use strokes to represent court cases on a calendar. And you can count the former instead of the latter.

Page 133

This isn't so, if, say, I want to count hat-sizes. It would be unnatural to represent three hat-sizes by three strokes. Just as if I were to represent a measurement, 3 ft, by 3 strokes. You can certainly do so, but then '|||' represents in a different way.

Page 133

If 3 strokes on paper are the sign for the number 3, then you can say the number 3 is to be applied in the way in which the 3 strokes can be applied.

Page 133

Of what 3 strokes are a picture, of that they can be used as a picture.

Page 133

113 The natural numbers are a form given in reality through things, as the rational numbers are through extensions etc. I mean, by actual forms. In the same way, the complex numbers are given by actual manifolds. (The *symbols* are actual.)

Page 133

What distinguishes a statement of number about the extension of a concept from one about the range of a variable? The first is a proposition, the second not. For the statement of number about

Page Break 134

a variable can be derived from the variable itself. (It must show itself.)

Page 134

But can't I specify a variable by saying that its values are to be all objects satisfying a certain material function? In that case the variable is not a form! And then the sense of one proposition depends on whether another is true or false.

Page 134

A statement of number about a variable consists in a transformation of the variable rendering the number of its values visible.

Page 134

114 What kind of proposition is 'There is a prime number between 5 and 8'? I would say 'That shows itself'. And that's correct, but can't you draw attention to this internal state of affairs? You could surely say: Search the interval between 10 and 20 for prime numbers. How many are there? Wouldn't that be a straightforward problem? And how would its result be correctly expressed or represented? What does the proposition 'There are 4 primes between 10 and 20' mean?

Page 134

This proposition seems to draw our attention to a particular aspect of the matter.

Page 134

If I ask someone, 'How many primes are there between 10 and 20?', he may reply, 'I don't know straight off, but I can work it out any time you like.' For it's as if there were somewhere where it was already written out.

Page 134

If you want to know what a proposition means, you can always ask 'How do I know that?' Do I know that there are 6 permutations of 3 elements in the same way in which I know there are 6 people in this room? No. Therefore the first proposition is of a different *kind* from the second.

Page 134

Another equally useful question is 'How would this proposition actually be used in practice?'; and there the proposition from the theory of combinations is of course used as a law of inference in the transition from one proposition to another, each of which describes a reality, not a *possibility*.

Page Break 135

Page 135

You can, I think, say in general that the use of apparent propositions about possibilities--and impossibilities--is always in the passage from one actual proposition to another.

Page 135

Thus I can, e.g., infer from the proposition 'I label 7 boxes with permutations of a, b, c ' that at least *one* of the labels is repeated.--And from the proposition 'I distribute 5 spoons among 4 cups' it follows that one cup gets 2 spoons, etc.

Page 135

If someone disagrees with us about the number of men in this room, saying there are 7, while we can only see 6, we can understand him even though we disagree with him. But if he says that for him there are 5 pure colours, in that case we don't understand him, or must suppose we completely misunderstand one another. This number is demarcated in dictionaries and grammars and not within language.

Page Break 136

XI

Page 136

115 A statement of number doesn't always contain something general or indefinite: 'The interval AB is divided into two (3, 4 etc.) equal parts.'

Page 136

There doesn't even need to be a certain element of generality in a statement of number.' Suppose, e.g., I say 'I see three equal circles equidistant from one another'.

Page 136

If I give a correct description of a visual field in which three red circles stand on a blue ground, it surely won't take the form of saying ' $(\exists x, y, z): x$ is circular and red and y is circular and red, etc. etc.'

Page 136

You might of course write it like this: there are 3 circles with the property of being red. But at this point the difference emerges between improper objects--colour patches in a visual field, sounds, etc. etc.--and the elements of knowledge, the genuine objects.

Page 136

It is plain that the proposition about the three circles isn't general or indefinite in the way a proposition of the form $(\exists x, y, z) \cdot \phi x \cdot \phi y \cdot \phi z$ is. That is, in such a case, you may say: Certainly I know that three things have the property ϕ , but I don't know *which*; and you can't say this in the case of three circles.

Page 136

'There are now 3 red circles of such and such a size and in such and such a place in my visual field' determines the facts completely and it would be nonsense to say I don't know *which* circles they are.

Page 136

Think of such 'objects' as: a flash of lightning, the simultaneous occurrence of two events, the point at which a line cuts a circle, etc.; the three circles in the visual field are an example for all these cases.

Page 136

You can of course treat the subject-predicate form (or, what comes to the same thing, the argument-function form) as a norm

Page Break 137

of representation, and then it is admittedly important and characteristic that whenever we use numbers, the number may be represented as the property of a predicate. Only we must be clear about the fact that now we are not dealing with objects and concepts as the results of an analysis, but with moulds into which we have squeezed the proposition. And of course it's significant that it can be fitted into this mould. But squeezing something into a mould is the opposite of analysis. (If you want to study the natural growth of an apple tree, you don't look at an espalier tree--except to see how *this* tree reacts to *this* pressure.)

Page 137

That implies the Fregean theory of number would be applicable provided we were not intending to give an analysis of propositions. This theory explains the concept of number for the idioms of everyday speech. Of course, Frege would have said (I remember a conversation we had) that the simultaneous occurrence of an eclipse of the moon and a court case was an object. And what's wrong with that? Only that we in that case use the word 'object' ambiguously, and so throw the results of the analysis into disarray.

Page 137

If I say, 'There are 4 men in this room', then at any rate a disjunction seems to be involved, since it isn't said *which* men. But this is quite inessential. We could imagine all men to be indistinguishable from one another apart

from their location (so that it would be a question of humanity at a particular place), and in that case all indefiniteness would vanish.

Page 137

116 If I am right, there is no such concept as 'pure colour'; the proposition 'A has a pure colour' simply means 'A is red, or yellow, or green, or blue'. 'This hat belongs to either A or B or C' isn't the same proposition as 'This hat belongs to someone in this room', even if as a matter of fact only A, B, and C are in the room, since that needs saying.--'There are two pure colours on this surface', *means* 'On this surface there is red and yellow, or red and blue, or red and green etc.'

Page 137

Even if I may not say 'There are four pure colours', still the pure colours and the number 4 are somehow connected, and that must

Page Break 138

come out in some way or other, e.g. if I say, 'I can see 4 colours on this surface: yellow, blue, red and green.'

Page 138

The situation must be exactly similar for permutations. The permutations (without repetition) of *AB* are *AB*, *BA*. They are not the extension of a concept: they alone are the concept. But in that case you cannot say of these that they are two. And yet apparently we do just that in the theory of combinations. It strikes me as a question of a correlation similar to the one between algebra and inductions in arithmetic. Or is the connection the same as that between geometry and arithmetic? The proposition that there are two permutations of *AB* is in fact completely on all fours with the proposition that a line meets a circle in 2 points. Or, that a quadratic equation has two roots.

Page 138

If we say that *AB* admits of two permutations, it sounds as though we had made a *general* assertion, analogous with 'There are two men in the room', in which nothing further is said or need be known about the men. But this isn't so in the *AB* case. I cannot give a more general description of *AB*, *BA*, and so the proposition that two permutations are possible cannot say any less than that the permutations *AB*, *BA* are possible. To say that 6 permutations of 3 elements are possible cannot say less, i.e. anything more general, than is shown by the schema:

ABC
ACB
BAC
BCA
CAB
CBA

For it's *impossible* to know the number of possible permutations without knowing which they are. And if this weren't so, the theory of combinations wouldn't be capable of arriving at its general formulae. The law which we see in the formulation of the permutations is represented by the equation $p = n!$ In the same sense, I believe, as that in which a circle is given by its equation.

--Of course, I can correlate the number 2 with the permutations *AB*, *BA*, just as I can 6 with the complete set of permutations of *A*, *B*, *C*, but this doesn't give me the theorem of combination

Page Break 139

theory--What I see in *AB*, *BA* is an internal relation which therefore cannot be described.--That is, *what* cannot be described is that which makes this class of permutations complete.--I can only count what is actually there, not possibilities. But I can, e.g., work out how many rows a man must write if in each row he puts a permutation of 3 elements and goes on until he can't go any further without repetition. And this means he needs 6 rows to write down the permutations *ABC*, *ACB*, etc. since these just are '*the* permutations of *A*, *B*, *C*'. But it makes no sense to say that these are all the permutations of *A*, *B*, *C*.

Page 139

117 We could imagine a combination computer exactly like the Russian abacus.

Page 139

It is clear that there is a mathematical question: 'How many permutations of--say--4 elements are there?', a question of precisely the same kind as 'What is 25×18 ?'. For in both cases there is a general method of solution.

Page 139

But still it is only with respect to this method that this question exists.

Page 139

The proposition that there are 6 permutations of 3 elements is identical with the permutation schema, and thus there isn't here a proposition, 'There are 7 permutations of 3 elements', for no such schema corresponds to it.

You may also say that the proposition 'There are 6 permutations of 3 elements' is related to the proposition 'There are 6 people in this room' in precisely the same way as is '3 + 3 = 6', which you could also cast in the form 'There are 6 units in 3 + 3'. And just as in the one case I can count the rows in the permutation schema, so in the

other I can count the strokes in .

Just as I can prove that $4 \times 3 = 12$ by means of the schema:

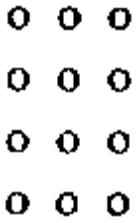

I can also prove $3! = 6$ by means of the permutation schema.

118 What is meant by saying I have as many spoons as *can* be put in 1-1 correspondence with a dozen bowls?

Either this proposition assumes I have 12 spoons, in which case I can't say that they can be correlated with the 12 bowls, since the opposite would be impossible; or else it doesn't assume I have 12 spoons, in which case it says I *can* have 12 spoons, and that's self-evident and once more cannot be said.

You could also ask: does this proposition say any *less* than that I have 12 spoons? Does it say something which only together with another proposition implies that I have 12 spoons? If p follows q alone, then q already says p . An apparent process of thought, making the transition, doesn't come in.

The symbol for a class is a list.

Can I know there are as many apples as pears on this plate, without knowing how many? And what is meant by not knowing how many? And how can I find out how many? Surely by counting. It is obvious that you can discover that there are the same number by correlation, without counting the classes.



In Russell's theory only an *actual* correlation can show the 'similarity' of two classes. Not the *possibility* of correlation, for this consists precisely in the numerical equality. Indeed, the possibility must be an *internal* relation between the extensions of the concepts, but this internal relation is only given through the equality of the 2 numbers.

A cardinal number is an internal property of a list.

119 We divide the evidence for the occurrence of a physical event according to the various kinds of such evidence, into the heard, seen, measured etc., and see that in each of these taken singly there is a formal element of order, which we can call space.

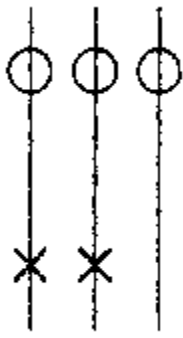

Page 141

What sort of an *impossibility* is the impossibility, e.g., of a 1-1 correlation between 3 circles and 2 crosses? We could also ask--and it would obviously be a question of the same sort--what sort of an impossibility is the impossibility of making a correlation by drawing parallel lines, if the arrangement is the given one?

Page 141

That a 1-1 correlation is possible is shown in that a significant proposition--true or false--asserts that it obtains. And that the correlation discussed above is not possible is shown by the fact that we cannot describe it.

Page 141

We can say that there are 2 circles in this square, even if in reality there are 3, and this proposition is simply false. But I cannot say that this group of circles is comprised of 2 circles, and just as little that it's comprised of 3 circles, since I should then be ascribing an *internal* property.

Page 141

It is nonsense to say of an extension that it has such and such a number, since the number is an *internal* property of the extension. But you can ascribe a number to the concept that collects the extension (just as you can say that this extension satisfies the concept).

Page 141

120 It is remarkable that in the case of a tautology or contradiction you actually could speak of sense and reference in Frege's sense.

Page 141

If we call its property of being a tautology the reference of a tautology, then we may call the way in which the tautology comes about here the sense of the tautology. And so for contradiction.

Page 141

If, as Ramsey proposed, the sign '=' were explained by saying that $x = x$ is a tautology, and $x = y$ a contradiction, then we may say that the tautology and the contradiction have no 'sense' here.

Page Break 142

Page 142

So, if a tautology shows something through the fact that just *this* sense gives *this* reference, then a tautology à la Ramsey shows nothing, since it is a tautology by definition.

Page 142

What then is the relation between the sign '**Def** = ' and the equals sign explained by means of tautology and contradiction?

Page 142

Is ' $p \cdot q = \sim(\sim p \vee \sim q)$ ' a tautology for the latter? You could say ' $p \cdot q = p \cdot q$ ' is taut., and since according to the definition you may substitute ' $\sim(\sim p \vee \sim q)$ ' for one of the signs ' $p \cdot q$ ', the previous expression is also a tautology.

Page 142

Hence you should not write the explanation of the equals sign thus:

$x = x$ is taut.
 $x = y$ is contra.

but must say: if, and *only* if, 'x' and 'y' have the same reference according to the sign-rules, then ' $x = y$ ' is taut: if 'x' and 'y' do not have the same reference according to the sign-rules, then ' $x = y$ ' is contra. In that case it would be to the point to write the equals sign thus defined differently, to distinguish it from ' $x = y$ ', which represents a rule for signs and says that we may substitute y for x. That is just what I cannot gather from the sign as explained above, but only from the fact that it is a tautology, but I don't know that either unless I already know the rules of substitution.

Page 142

It seems to me that you may compare mathematical equations only with significant propositions, not with

tautologies. For an equation contains precisely this assertoric element--the equals sign--which is not designed for showing something. Since whatever shows itself, shows itself without the equals sign. The equals sign doesn't correspond to the ' \supset .' in ' $p \bullet (p \supset q) \supset q$.' since the ' \supset .' is only *one* element among others which go to make up the tautology. It doesn't drop out of its context, but belongs to the proposition, in the same way that the ' \bullet ' or ' \supset ' do. But the '=' is a copula, which alone makes the equation into something

Page Break 143

propositional. A tautology shows something, an equation shows nothing: rather, it indicates that its sides show something.

Page 143

121 An equation is a rule of syntax.

Page 143

Doesn't that explain why we cannot have questions in mathematics that are in principle unanswerable? For if the rules of syntax cannot be grasped, they're of no use at all. And equally, it explains why an infinity that transcends our powers of comprehension cannot enter into these rules. And it also makes intelligible the attempts of the formalists to see mathematics as a game with signs.

Page 143

You may certainly construe sign-rules, for example definitions, as propositions about signs, but you don't *have to* treat them as propositions at all. They belong to the devices of language. Devices of a different kind from the propositions of language.

Page 143

Ramsey's theory of identity makes the mistake that would be made by someone who said that you could use a painting as a mirror as well, even if only for a single posture. If we say this, we overlook that what is essential to a mirror is precisely that you can infer from it the posture of a body in front of it, whereas in the case of the painting you have to know that the postures tally before you can construe the picture as a mirror image.

Page 143

Weyl's [\dagger 1] 'heterological' paradox:

$$\begin{array}{l} \text{Def} \qquad \qquad \qquad \text{Def} \\ \sim \phi (\phi) = \text{'}\phi \text{' is heterological} = F (\phi) \\ F(F) = \sim F(F) = \sim[\sim(\hat{\phi}(\hat{\phi}))(\sim(\hat{\phi}(\hat{\phi})))] \end{array}$$

Page 143

122 We may imagine a mathematical proposition as a creature which itself knows whether it is true or false. (In contrast with genuine propositions.)

Page 143

A mathematical proposition itself knows that it is true or that it

Page Break 144

is false. If it is about all the numbers, it must also survey all the numbers.

Page 144

Its truth or falsity must be contained in it, as is its sense.

Page 144

It's as though the generality of such a proposition as ' $(n) \sim \text{Chr } n$ ' were only a pointer to the genuine, actual, mathematical generality of a proposition [\dagger 1]. As though it were only a description of the generality, not the generality itself. As if the proposition formed a sign only in a purely external way and you still needed to give the sign a sense from within.

Page 144

We feel the generality possessed by the mathematical assertion to be different from the generality of the proposition proved.

Page Break 145

Page 145

How is a mathematical problem related to its solution?

Page 145

We could say: a mathematical proposition is an allusion to a proof.

Page 145

A generalization cannot be both empirical and provable.

Page 145

If a proposition is to have a definite sense (and it's nonsense otherwise), it must comprehend--survey--its sense completely; a generalization only makes sense if it--i.e. all values of its variables--is completely determined.

Page Break 146

XII

Page 146

123 If, by making a series of tests, I advance along an endless stretch, why should it be any different in the case of an infinite one? And in that case of course, I can never get to the end.

Page 146

But if I only advance along the infinite stretch step by step, then I can't grasp the infinite stretch at all.

Page 146

So I grasp it in a different way; and if I have grasped it, then a proposition about it can only be verified in the way in which the proposition has taken it.

Page 146

So now it can't be verified by putative endless striding, since even such striding wouldn't reach a goal, since of course the proposition can outstrip our stride just as endlessly as before. No: it can only be verified by *one* stride, just as we can only grasp the totality of numbers at *one* stroke.

Page 146

We may also say: there is no path to infinity, *not even an endless one*.

Page 146

The situation would be something like this: We have an infinitely long row of trees, and so as to inspect them, I make a path beside them. All right, the path must be endless. But if it is endless, then that means precisely that you can't walk to the end of it. That is, it does *not* put me in a position to survey the row. (*Ex hypothesi* not.)

Page 146

That is to say, the endless path doesn't have an end 'infinitely far away', it has no end.

Page 146

124 It isn't just impossible 'for us men' to run through the natural numbers one by one; it's *impossible*, it means nothing.

Page 146

Nor can you say, 'A proposition cannot deal with all the numbers

Page Break 147

one by one, so it has to deal with them by means of the concept of number', as if this were a *pis aller*: 'Because we can't do it *like this*, we have to do it another way.' But it's not like that: of course it's possible to deal with the numbers one by one, but that *doesn't* lead to the totality. For the totality is only given as a concept.

Page 147

If it's objected that 'if I run through the number series I either eventually come to the number with the required property, or I never do', we need only reply that it makes no sense to say that you *eventually* come to the number and *just as little* that you *never* do. Certainly it's correct to say 101 is or is not the number in question. But you can't talk about *all* numbers, because there's no such thing as *all* numbers.

Page 147

125 Can you say you couldn't foresee that $6 - 4$ would be precisely 2, but only see it when you get there?

Page 147

That, in the case of the logical concept $(1, \xi, \xi + 1)$, the existence of its objects is already given with the concept, of itself shows that it determines them.

Page 147

Besides, it's quite clear that every number has its own irreducible individuality. And if I want to prove that a number has a certain property, in one way or another I must always bring in the number itself.

Page 147

In this sense you might say that the properties of a particular number cannot be *foreseen*. You can only see them when you've got there.

Page 147

Someone may say: Can't I prove something about the number 3^{10} , even though I can't write it down? Well, 3^{10} already is the number, only written in a different way.

What is fundamental is simply the repetition of an operation. Each stage of the repetition has its own individuality.

But it isn't as if I use the operation to move from one individual to another so that the operation would be the means for getting from one to the other--like a vehicle stopping at every number

which we can then study: no, applying the operation $+ 1$ three times yields and *is* the number 3.

An 'infinitely complicated law' means no law at all. How are you to know it's infinitely complicated? Only by there being as it were infinitely many approximations to the law. But doesn't that imply that they in fact *approach* a limit? Or could the infinitely many descriptions of intervals of the prime number series be called such approximations to a law? No, since no description of a finite interval takes us any nearer the goal of a complete description.

Then how would an infinitely complicated law in this sense differ from no law at all?

In that case, the law would, at best, run 'Everything is as it is'.

126 Yet it still looks now as if the quantifiers make no sense for numbers. I mean: you can't say ' $(n) \cdot \phi n$ ', precisely because 'all natural numbers' isn't a bounded concept. But then neither should one say a general proposition follows from a proposition about the nature of number.

But in that case it seems to me that we can't use generality--all, etc.--in mathematics at all. There's no such thing as 'all numbers', simply because there are infinitely many. And because it isn't a question here of the amorphous 'all', such as occurs in 'All the apples are ripe', where the set is given by an external description: it's a question of a collection of structures, which must be given precisely as such.

It's, so to speak, no business of logic how many apples there are when we talk of all the apples. Whereas it's different in the case of the numbers: there, it has an individual responsibility for each one of them.

127 What is the meaning of such a mathematical proposition as ' $(\exists n) \cdot 4 + n = 7$ '? It might be a disjunction - $4 + 0 = 7 \cdot \vee \cdot 4 + 1 = 7 \cdot \vee \cdot 4 + 2 = 7 \cdot \vee \cdot$ etc. *ad inf.* But what does that mean? I can

understand a proposition with a beginning and an end. But can one also understand a proposition with no end? [\dagger 1]

I also find it intelligible that one can give an infinite rule by means of which you may form infinitely many finite propositions. But what does an endless proposition mean?

If no finite product makes a proposition true, that means no product makes it true. And so it *isn't* a logical product.

128 But then can't I say of an equation 'I know it doesn't hold for some substitution--I've forgotten now which; but whether it doesn't hold in general, I don't know'? Doesn't that make good sense, and isn't it compatible with the generality of the inequality?

Is the reply: 'If you know that the inequality holds for some substitution, that can never mean "for some (arbitrary) member of the infinite number series", but I always know too that this number lies between 1 and 10^7 , or within some such limits'?

Can I know that a number satisfies the equation without a finite section of the infinite series being marked out as one within which it occurs? No.

'Can God know all the places of the expansion of π ?' would have been a good question for the schoolmen to ask. In all such cases the answer runs, 'The question is senseless.'

'No degrees of brightness below this one hurt my eyes': that means, I have observed that my previous experiences correspond to a formal law.

129 A proposition about all propositions, or all functions, is *a priori* an impossibility: what such a proposition is intended to express would have to be shown by an induction. (For instance, that *all* propositions $\sim 2^n p$ say the same.) [†1]

This induction isn't itself a proposition, and that excludes there being any vicious circle.

What do we want to differentiate propositions from when we form the concept 'proposition'?

Isn't it the case that we can only give an external description of propositions in general?

Equally, if we ask: Is there a general form of law? As opposed to what? Laws must of course fill the whole of logical space, and so I can no longer mark them off.

Generality in arithmetic is indicated by an induction.
An induction is the expression for arithmetical generality.

Suppose one of the rules of a game ran 'Write down a fraction between 0 and 1'. Wouldn't we understand it? Do we need any limits here? And what about the rule 'Write down a number greater than 100'? Both seem thoroughly intelligible.

I have always said you can't speak of *all* numbers, because there's no such thing as 'all numbers'. But that's only the expression of a feeling. Strictly, one should say,... 'In arithmetic we never *are* talking about *all* numbers, and if someone nevertheless does speak in that way, then he so to speak invents something--nonsensical

--to supplement the arithmetical facts.' (Anything invented as a supplement to *logic* must of course be nonsense.)

130 It is difficult to extricate yourself completely from the extensional viewpoint: You keep thinking 'Yes, but there must still be an internal relation between $x^3 + y^3$ and z^3 , since the extension, if only I knew it, would have to show the result of such a relation.' Or perhaps: 'It must surely be either *essential* to *all* n to have the property or not, even if I can't know it.'

If I write ' $(\exists x) \bullet x^2 = 2x$ ', and don't construe the ' $(\exists x)$ ' extensionally, it can only mean: 'If I apply the rules for solving such an equation, I arrive at a particular number, in contrast with the cases in which I arrive at an identity or a prohibited equation.'

The defect (circle) in Dedekind's explanation of the concept of infinity lies in its application of the concept 'all' in the formal implication that holds independently if one may put it like this--of the question whether a finite or an infinite number of objects falls under its concepts. The explanation simply says: if the one holds of an object, so does the other. It does not consider the totality of objects at all, it only says something about the object at the moment in front of it, and *its application* is finite or infinite as the case may be.

But how are we to know such a proposition?--How is it verified? What really corresponds to what we mean isn't a proposition at all, it's the *inference* from ϕx to ψx , if this inference is permitted--but the inference isn't expressed by a proposition.

What does it mean to say a line can be extended indefinitely? Isn't this a case of an 'and so on *ad inf.*' that is quite different from that in mathematical induction? According to what's gone before, the expression for the possibility of extending it further would exist in the sense of a description of the extended line or of the act

of extending it. Now at first this doesn't seem to be connected with numbers at all. I can imagine the pencil drawing the line going on moving and keeping on for ever. But is it also conceivable that there should be no possibility of accompanying this process with a countable process? I think not.

131 The generality of a Euclidean proof. We say, the demonstration is carried out for *one* triangle, but the proof holds for all triangles--or for an arbitrary triangle. First, it's strange that what holds for one triangle should therefore hold for every other. It wouldn't be possible for a doctor to examine *one* man and then conclude that what he had found in his case must also be true of every other. And if I now measure the angles of a triangle and add them, I can't in fact conclude that the sum of the angles in every other triangle will be the same. It is clear that the Euclidean proof can say nothing about a totality of triangles. A proof can't go beyond itself.

But once more the construction of the proof is not an experiment, and were it so, its outcome couldn't prove anything for other cases. That is why it isn't even necessary for the construction actually to be carried out with pencil and paper, but a description of the construction must be sufficient to show all that is essential. (The description of an experiment isn't enough to give us the result of the experiment: it must actually be performed.) The construction in a Euclidean proof is precisely analogous to the proof that $2 + 2 = 4$ by means of the Russian abacus.

And isn't this the kind of generality the tautologies of logic have, which are demonstrated for p, q, r , etc.?

The essential point in all these cases is that what is demonstrated can't be expressed by a proposition.

132 If I say 'The world will *eventually* come to an end' then that means nothing at all if the date is left indefinitely open. For it's compatible with this statement that the world should still exist on any day you care to mention.--What is *infinite* is the *possibility* of numbers in propositions of the form 'In n days the world will come to an end'.

To understand the sense of a question, consider what an answer to it would look like.

To the question 'Is A my ancestor?' the only answers I can imagine are 'A is to be found in my ancestral gallery' or 'A is not to be found in my ancestral gallery' (Where by my ancestral gallery I understand the sum total of all kinds of information about my predecessors). But in that case the question can't mean anything more than 'Is A to be found in my ancestral gallery?' (An ancestral gallery has an end: that is a proposition of syntax.) If a god were to reveal to me that A was my ancestor, but not at what remove, even this revelation could only mean to me that I shall find A among my ancestors if I search long enough; but since I shall search through N ancestors, the revelation must mean that A is one of those N.

If I ask how many 9s immediately succeed one another after 3.1415 in the development of π , meaning my question to refer to the extension, the answer runs either, that in the development of the extension up to the place last developed (the N th) we have gone beyond the series of 9s, or, that 9s succeed one another up to the N th place. But in this case the question cannot have a different sense from 'Are the first $N - 5$ places of π all 9s or not?'--But of course, that isn't the question which interests us.

133 In philosophy it's always a matter of the application of a series of utterly simple basic principles that any child knows, and the--enormous--difficulty is only one of applying these in the confusion our language creates. It's never a question of the latest

results of experiments with exotic fish or the most recent developments in mathematics. But the difficulty in applying the simple basic principles shakes our confidence in the principles themselves.

134 What sort of proposition is: 'On this strip you may see all shades of grey between black and white'? Here it looks at first glance as if we're talking about infinitely many shades.

Indeed we are apparently confronted here by the paradox that we can, of course, only distinguish a finite number of shades, and naturally the distinction between them isn't infinitely slight, and yet we see a continuous

transition.

Page 154

It is just as impossible to conceive of a particular grey as being one of the infinitely many greys between black and white as it is to conceive of a tangent t as being one of the infinitely many transitional stages in going from t_1 to t_2 . If I see a ruler roll from t_1 to t_2 , I see--if its motion is continuous--none of the individual intermediate positions in the sense in which I see t when the tangent is at rest; or else I see only a finite number of such positions.

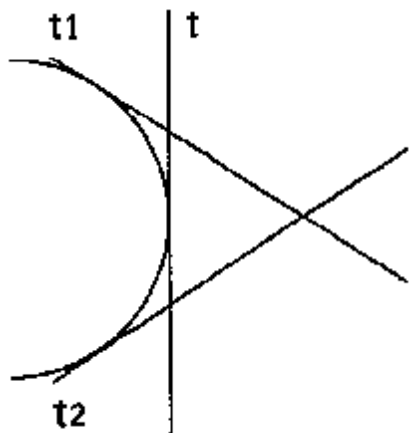

Page 154

But if in such a case I appear to infer a particular case from a general proposition, then the general proposition is never derived from experience, and the proposition isn't a real proposition.

Page 154

If, e.g., I say 'I saw the ruler move from t_1 to t_2 , therefore I must have seen it at t ', this doesn't give us a valid logical inference. That is, if what I mean is that the ruler must have *appeared* to me at t --and so, if I'm talking about the position in visual space--then it doesn't in the least follow from the premiss. But if I'm talking about the physical ruler, then of course it's possible for the ruler to have skipped over

Page Break 155

position t , and yet for the phenomena in visual space to have remained continuous.

Page 155

135 Ramsey proposed to express the proposition that infinitely many objects satisfied a function by denying all propositions of the form:

$$\begin{aligned} &\sim(\exists x) \cdot \phi x \\ &(\exists x) \cdot \phi x \cdot \sim(\exists x, y) \cdot \phi x \cdot \phi y \\ &(\exists x, y) \cdot \phi x \cdot \phi y \cdot \sim(\exists x, y, z) \cdot \phi x \cdot \phi y \cdot \phi z, \text{ etc.} \end{aligned}$$

But let's suppose there are only three objects, i.e., there are only three names with a meaning. Then we can no longer write down the fourth proposition of the series, since it makes no sense to write: $(\exists x, y, z, u) \cdot \phi x \cdot \phi y \cdot \phi z \cdot \phi u$. So I don't arrive at the infinite by denying all the propositions in this series.

Page 155

'We only know the infinite by description.' Well then, there's just the description and nothing else.

Page 155

136 To what extent does a notation for the infinite presuppose infinite space or infinite time?

Page 155

Of course it doesn't presuppose an infinitely large sheet of paper. But how about the possibility of one?

Page 155

We can surely imagine a notation which extends through time, not space. Such as speech. Here too we clearly find it possible to imagine a representation of infinity, yet in doing so we certainly don't make any *hypothesis* about time. Time appears to us to be essentially an *infinite* possibility.

Page 155

Indeed, obviously infinite from what we know of its structure.

Page 155

Surely it's impossible that mathematics should depend on an hypothesis concerning physical space. And surely in this sense *visual space* isn't infinite.

Page 155

And if it's a matter, not of the reality, but of the possibility of the hypothesis of infinite space, then this

possibility must surely be prefigured somewhere.

Page Break 156

Page 156

Here we run into the problem that also arises for the extension of visual space that of the smallest visible distinction. The existence of a smallest visible distinction conflicts with continuity, and yet the two must be reconcilable with one another.

Page 156

137 If I have a series of alternately black and white patches, as shown in the diagram



then by continual bisection, I will soon arrive at a limit where I'm no longer able to distinguish the black and white patches, that is, where I have the impression of a grey strip.

Page 156

But doesn't that imply that a strip in my visual field cannot be bisected indefinitely often? And yet I don't see a discontinuity and of course I wouldn't, since I could only see a discontinuity if I hadn't yet reached the limit of divisibility.

Page 156

This seems very paradoxical.

Page 156

But what about the continuity between the individual rows? Obviously we have a last but one row of distinguishable patches and then a last row of uniform grey; but could you tell from this last row that it was in fact obtained by bisecting the last but one? Obviously not. On the other hand, could you tell from the so-called last but one row that it can no longer be visibly bisected? It seems to me, just as little. In that case, there would be no last visibly bisected row!

Page 156

If I cannot visibly bisect the strip any further, I can't even *try* to, and so can't see the failure of such an attempt. (This is like the case of the limitlessness of visual space.)

Page 156

Obviously, the same would hold for distinctions between colours.

Page Break 157

Page 157

Continuity in our visual field consists in our not seeing discontinuity.

Page 157

138 But if I can always see only a finite number of things, divisions, colours, etc., than there just isn't an infinity at all; in no sense whatever. The feeling here is: if I am always able to see only so few, then there aren't any more. As if it were a case like this: if I can only see 4, then there aren't 100. But infinity doesn't have the role of a number here. It's perfectly true; if I can only see 4, there aren't 100, there aren't even 5. But there is the infinite possibility that isn't exhausted by a small number any more than by a large: and in fact just because it *isn't* itself a quantity.

Page 157

We all of course know what it means to say there is an infinite possibility and a finite reality, since we say space and time are infinite but we can always only see or live through finite bits of them. But from where, then, do I derive any knowledge of the infinite at all? In some sense or other, I must have two kinds of experience: one which is of the finite, and which cannot transcend the finite (the idea of such a transcendence is nonsense even on its own terms), and one of the infinite. And that's how it is. Experience as experience of the facts gives me the finite; the objects *contain* the infinite. Of course not as something rivalling finite experience, but in intension. Not as though I could see space as practically empty, with just a very small finite experience in it. But, I can see in space the possibility of any finite experience. That is, no experience could be too large for it or exhaust it: not of course

because we are acquainted with the dimensions of every experience and know space to be larger, but because we understand this as belonging to the essence of space.--We recognize this essential infinity of space in its smallest part.

Page 157

Where the nonsense starts is with our habit of thinking of a large number as closer to infinity than a small one.

Page 157

As I've said, the infinite doesn't rival the finite. The infinite is that whose essence is to exclude nothing finite.

Page Break 158

Page 158

The word 'nothing' occurs in this proposition and, once more, this should not be interpreted as the expression for an infinite disjunction, on the contrary, 'essentially' and 'nothing' belong together. It's no wonder that time and again I can only explain infinity in terms of itself, i.e. *cannot explain* it.

Page 158

Space has no extension, only spatial objects are extended, but infinity is a property of space.

Page 158

(This of itself shows it isn't an infinite extent.)

Page 158

And the same goes for time.

Page 158

139 How about infinite divisibility? Let's remember that there's a point to saying we can conceive of *any* finite number of parts but not of an infinite number; but that this is precisely what constitutes infinite divisibility.

Page 158

Now, 'any' doesn't mean here that we can conceive of the *sum total* of *all* divisions (which we can't, for there's no such thing). But that there is the *variable* 'divisibility' (i.e. the concept of divisibility) which *sets no limit* to actual divisibility; and that constitutes its infinity.

Page 158

But how do we construct an infinite hypothesis, such as that there are infinitely many fixed stars (it's clear that *in the end* only a finite reality can correspond to it)? Once more it can only be given through a law. Let's think of an infinite series of red spheres.--Let's think of an infinite film strip. (It would give the possibility of everything finite that happens on the screen.) This is a typical case of an hypothesis reaching out to infinity. It's clear to us that no experience *corresponds* with it. It only exists in 'the second system', that is, in language; but how is it expressed there? (If a man can *imagine* an infinite strip, then as far as he's concerned there is an infinite reality, and also the 'actual infinite' of mathematics.) It is expressed by a proposition of the form '(n): ($\exists nx$). ϕx '. Everything relating to the infinite possibility (every infinite assertion about the

Page Break 159

film), is reproduced in the expression in the first bracket, and the reality corresponding to it in the second.

Page 159

But what then has divisibility to do with actual division, if something can be divisible that *never is* divided?

Page 159

Indeed, what does divisibility mean at all in the case of that which is given as primary? How can you distinguish between reality and possibility here?

Page 159

It must be wrong to speak as I do of restricting infinite possibility to what is finite.

Page 159

For it makes it look as if an infinite reality were conceivable even if there isn't one and so once more as though it were a question of a possible infinite extension and an actual finite one: as though infinite possibility were the possibility of an infinite number.

Page 159

And that again shows we are dealing with two different meanings of the word 'possible' when we say 'The line can be divided into 3 parts' and when we say 'The line can be divided infinitely often'. (This is also indicated by the proposition above, which questions whether there are actual and possible in visual space.)

Page 159

What does it mean to say a patch in visual space can be divided into three parts? Surely it can mean only that a proposition describing a patch divided in this way makes sense. (Provided it isn't a question of a confusion

between the divisibility of physical objects and that of a visual patch.)

Page 159

Whereas infinite--or better *unlimited*--divisibility doesn't mean there's a proposition describing a line divided into infinitely many parts, since there isn't such a proposition. Therefore this possibility is not brought out by any reality of the signs, but by a possibility of a *different* kind in the signs themselves.

Page 159

If you say space is infinitely divisible, then strictly speaking that means: space isn't made up of individual things (parts).

Page 159

In a certain sense, infinite divisibility means that space is indivisible, that *it* is not affected by any division. That it is above such

Page Break 160

things: *it* doesn't consist of parts. Much as if it were saying to reality: you may do what you like in me (you can be divided as often as you like in me.)

Page 160

Space gives to reality an infinite opportunity for division.

Page 160

And that is why there is only *one* letter in the first bracket. Obviously only an opportunity, nothing more.

Page 160

140 Is primary time infinite? That is, is it an infinite possibility? Even if it is only filled out as far as memory extends, that in no way implies that it is finite. It is infinite in the same sense as the three-dimensional space of sight and movement is infinite, even if in fact I can only see as far as the walls of my room. For what I see presupposes the possibility of seeing further. That is to say, I could correctly represent what I see only by an infinite form.

Page 160

Is it possible to imagine time with an end, or with two ends?

Page 160

What can happen *now*, could also have happened earlier, and could always happen in the future if time remains as it is. But *that* doesn't depend on a future experience. Time contains the possibility of all the future *now*.

Page 160

But all that of itself implies that time isn't infinite in the sense of the primitive conception of an infinite set.

Page 160

And so for space. If I say that I can imagine a cylinder extended to infinity, that is already contained in its nature. So again, contained in the nature of the homogeneity of the cylinder and of the space in which it is--and the one of course presupposes the other and this homogeneity is in the finite bit that I see.

Page 160

The space of human movement is infinite in the same way as time.

Page 160

141 The rules for a number-system--say, the decimal system--

Page Break 161

contain everything that is infinite about the numbers. That, e.g. *these rules* set no limits on the left or right hand to the numerals; *this* is what contains the expression of infinity.

Page 161

Someone might perhaps say: True, but the numerals are still limited by their use and by writing materials and other factors. That is so, but that isn't expressed in the *rules* for their use, and it is only in these that their real essence is expressed.

Page 161

Does the relation $m = 2n$ correlate the class of all numbers with one of its subclasses? No. It correlates any arbitrary number with another, and in that way we arrive at infinitely many pairs of classes, of which one is correlated with the other, but which are *never* related as class and subclass. Neither is this infinite process itself in some sense or other such a pair of classes.

Page 161

In the superstition that $m = 2n$ correlates a class with its subclass, we merely have yet another case of ambiguous grammar.

Page 161

What's more, it all hangs on the syntax of reality and possibility. $m = 2n$ contains the *possibility of*

correlating any number with another, but doesn't correlate all numbers with others.

Page 161

The word 'possibility' is of course misleading, since someone will say, let what is possible now become actual. And in thinking this, we always think of a temporal process and infer from the fact that mathematics has nothing to do with time, that in its case possibility is (already) actuality.

Page 161

(But in truth the opposite is the case, and what is called possibility in mathematics is precisely the same as it is in the case of time.)

Page 161

$m = 2n$ points along the number series, and if we add 'to infinity', that simply means that it doesn't point at an object a definite distance away.

Page Break 162

Page 162

142 The infinite number series is itself only such a possibility as emerges clearly from the single symbol for it '(1, x , $x + 1$)' [†1]. This symbol is itself an arrow with the first '1' as the tail of the arrow and ' $x + 1$ ' as its tip and what is characteristic is that just as length is inessential in an arrow--the variable x shows here that it is immaterial how far the tip is from the tail.

Page 162

It is possible to speak of things which lie in the direction of the arrow but nonsense to speak of all possible positions for things lying in the direction of the arrow as an equivalent for this direction itself.

Page 162

A searchlight sends out light into infinite space and so illuminates everything in its direction, but you can't say it illuminates infinity.

Page 162

You could also put it like this: it makes sense to say there can be infinitely many objects in a direction, but no sense to say there are infinitely many. And this conflicts with the way the word 'can' is normally used. For, if it makes sense to say a book can lie on this table, it also makes sense to say it is lying there. But here we are led astray by language. The 'infinitely many' is so to speak used adverbially and is to be understood accordingly.

Page 162

That is to say, the propositions 'Three things can lie in this direction' and 'Infinitely many things can lie in this direction' are only apparently formed in the same way, but are in fact different in structure: the 'infinitely many' of the second proposition doesn't play the same role as the 'three' of the first.

Page 162

It is, again, only the ambiguity of our language that makes it appear as if numerals and the word 'infinite' are both given as answers to the same question. Whereas the questions which have these words as an answer are in reality fundamentally different.

Page Break 163

Page 163

(The usual conception really amounts to the idea that the absence of a limit is itself a limit. Even if it isn't put as baldly as that.)

Page 163

If two arrows point in the same direction, isn't it in such a case absurd to call these directions equally long because whatever lies in the direction of the one arrow, also lies in that of the other?

Page 163

Generality in mathematics is a direction, an arrow pointing along the series generated by an operation. And you can even say that the arrow points to infinity; but does that mean that there is something--infinity--at which it points, as at a thing? Construed in that way, it must of course lead to endless nonsense.

Page 163

It's as though the arrow designates the possibility of a position in its direction.

Page 163

143 In what sense is endless time a possibility and not a reality? For someone might object to what I am saying by arguing that time must be just as much a reality as, say, colour.

Page 163

But isn't colour taken by itself also only a possibility, until it is in a particular time and place? Empty infinite

time is only the possibility of facts which alone are the realities.

Page 163

But isn't the infinite *past* to be thought of as filled out, and doesn't that yield an infinite reality?

Page 163

And if there is an infinite reality, then there is also contingency in the infinite. And so, for instance, also an infinite decimal that isn't given by a law. Everything in Ramsey's conception stands or falls with that.

Page 163

That we don't think of time as an infinite reality, but as infinite in intension, is shown in the fact that on the one hand we can't imagine an infinite time interval, and yet see that no day can be the last, and so that time cannot have an end.

Page Break 164

Page 164

We might also say: infinity lies in the nature of time, it isn't the extension it happens to have.

Page 164

We are of course only familiar with time--as it were--from the bit of time before our eyes. It would be extraordinary if we could grasp its infinite extent in this way (in the sense, that is to say, in which we could grasp it if we ourselves were its contemporaries for an infinite time.)

Page 164

We are in fact in the same position with time as with space. The actual time we are acquainted with is limited (finite). Infinity is an internal quality of the form of time.

Page 164

144 The infinite number series is only the infinite possibility of finite series of numbers. It is senseless to speak of the *whole* infinite number series, as if it, too, were an extension.

Page 164

Infinite possibility is represented by infinite possibility. The signs themselves only contain the possibility and not the reality of their repetition [$\dagger 1$].

Page 164

Doesn't it come to this: the facts are finite, the infinite possibility of facts lies in the objects. That is why it is shown, not described.

Page 164

Corresponding to this is the fact that numbers--which of course are used to describe the facts--are finite, whereas their possibility, which corresponds with the *possibility* of facts, is infinite. It finds expression, as I've said, in the possibilities of the symbolism.

Page 164

The feeling is that there can't be possibility and actuality in mathematics. It's all on *one* level. And is, in a certain sense, actual.

Page Break 165

Page 165

And that is correct. For what mathematics expresses with its signs is all on *one* level; i.e. it doesn't speak sometimes about their possibility, and sometimes about their actuality. No, it can't even try to speak about their possibility. On the other hand, there is a possibility in its signs, i.e. the possibility found in genuine propositions, in which mathematics is applied.

Page 165

And when (as in set theory) it tries to *express* their possibility, i.e. when it confuses them with their reality, we ought to cut it down to size.

Page 165

We reflect far too little on the fact that a sign really cannot mean more than it is.

Page 165

The infinite possibility in the symbol relates--i.e. refers--only to the essence of a finite extension, and this is its way of leaving its size open.

Page 165

If I were to say, 'If we were acquainted with an infinite extension, then it would be all right to talk of an actual infinite', that would really be like saying, 'If there were a sense of abracadabra then it would be all right to talk about abracadabraic sense-perception'.

We see a continuous colour transition and a continuous movement, but in that case we just see *no* parts, *no* leaps (not infinitely many).

145 What is an infinite decimal not given by a rule? Can you give an infinite sequence of digits by a non-mathematical--and so external--description, instead of a law? (Very strange that there should be two modes of comprehension.)

'The number that is the result when a man endlessly throws a die', appears to be nonsense because no infinite number results from it.

But why is it easier to imagine life without end than an endless series in space? Somehow, it's because we simply take the endless

life as never complete, whereas the infinite series in space ought, we feel, already to exist as a whole.

Let's imagine a man whose life goes back for an infinite time and who says to us: 'I'm just writing down the last digit of π , and it's a 2'. Every day of his life he has written down a digit, without ever having begun; he has just finished.

This seems utter nonsense, and a *reductio ad absurdum* of the concept of an infinite *totality*.

Suppose we travel out along a straight line in Euclidean Space and say that at 10 m intervals we encounter an iron sphere of a certain diameter, *ad infinitum*; is this a construction? It seems so. What is strange is that you can construe such an infinite complex of spheres as the endless repetition of the same sphere in accordance with a certain law--and yet the moment you think of these spheres as each having its own individual characteristics, their infinite number seems to become nonsense.

Let's imagine an infinite row of trees, all of different heights between 3 and 4 yards. If there is a law governing the way the heights vary, then the series is defined and can be imagined by means of this law (this is assuming that the trees are indistinguishable save in their height). But what if the heights vary at random? Then--we're forced to say--there's only an infinitely long, an endless description. But surely that's not a description! I can suppose there to be infinitely many descriptions of the infinitely many finite stretches of the infinite row of trees, but in that case I have to know these infinitely many descriptions by means of a law governing their sequence. Or, if there's no such law, I once more require an infinite description of these descriptions. And that would again get me nowhere.

Now I could of course say that I'm aware of the law that each tree must differ in height from all its predecessors. It's true that this

is a law, but still not such as to define the series. If I now assume there could be a random series, then that is a series about which, by its very nature, nothing can be known apart from the fact that I can't know it. Or better, that it can't be known. For is this a situation in which 'the human intellect is inadequate, but a higher might succeed'? How then does it come about that human understanding frames this question at all, sets out on this path whose end is out of its reach?

What is infinite about endlessness is only the endlessness itself.

146 What gives the multiplicative axiom its plausibility? Surely that in the case of a finite class of classes we can in fact make a selection [choice]. But what about the case of infinitely many subclasses? It's obvious that in such a case I can only know the law for making a selection.

Now I can make something like a *random* selection from a finite class of classes. But is that *conceivable* in the case of an infinite class of classes? It seems to me to be nonsense.

Let's imagine someone living an endless life and making successive choices of an arbitrary fraction from the fractions between 1 and 2, 2 and 3, etc. *ad. inf.* Does that yield us a selection from all those intervals? No, since he does *not* finish. But can't I say nonetheless that all those intervals must turn up, since I can't cite any which he wouldn't *eventually* arrive at? But from the fact that given *any* interval, he will *eventually* arrive at it, it doesn't follow that he will *eventually* have arrived at them all.

Page 167

But doesn't this still give the description of a process that generates selections without end, and doesn't that mean precisely that an endless selection is formed? But here the infinity is only in the rule.

Page 167

Imagine the following hypothesis: there is in space an infinite series of red spheres, each one metre behind its predecessor. What

Page Break 168

conceivable experience could correspond to this hypothesis? I think for instance of my travelling along this series and every day passing a certain number, *n*, of red spheres. In that case, my experience ought to consist in the fact that on *every possible* day in the future I see *n* more spheres. But when shall I have had this experience? Never!

Page 168

147 You can only answer the objection 'But if nevertheless there were infinitely many things?' by saying 'But there aren't'. And what makes us think that perhaps there are is only our confusing the things of physics with the elements of knowledge [†1].

Page 168

For this reason we also can't suppose an hypothetical infinite visual space in which an infinite series of red patches is visible.

Page 168

What we imagine in physical space is not that which is primary, which we can know only to a greater or lesser extent; rather, what we can know of physical space shows us how far what is primary reaches and how we have to *interpret* physical space.

Page 168

But how is a proposition of the form 'The red patch *a* lies somewhere between *b* and *c*' to be analysed? This doesn't mean: 'The



patch *a* corresponds to one of the infinitely many numbers lying between the numbers of *b* and *c*' (it isn't a question of a disjunction). It's clear that the infinite possibility of positions of *a* between *b* and *c* isn't expressed in the proposition. Just as, in the case of 'I have locked him in the room', the infinitely many possible positions

Page Break 169

of the man shut in the room play no role whatever.

Page 169

'Each thing has one and only one predecessor; *a* has no successor; everything except for *a* has one and only one successor.' These propositions appear to describe an infinite series (and also to say that there are infinitely many things. But this would be a presupposition of the propositions' making sense). They appear to describe a *structure amorously*. We can sketch out a structure in accordance with these propositions, which they describe unambiguously. But where can we discover this structure in them?

Page 169

But couldn't we regard this set of propositions simply as propositions belonging to physics, setting out a scientific hypothesis? In that case they would have to be unassailable. But what would it be like if a biologist discovered a species of animal, in which *every* individual appeared to be the offspring of *one* earlier one, and put this forward as an hypothesis?

Page 169

Are we misled in such a case by the illusion that parcels of matter--i.e. in this case the members of a species of animal--were the simple objects?

Page 169

That is to say, isn't that which we can imagine multiplied to infinity never the things themselves, but combinations of the things in accordance with their infinite possibilities?

The things themselves are perhaps the four basic colours, space, time and other data of the same sort.

In that case, how about a series of fixed stars, in which *each* has a predecessor (in a particular spacial direction)? And this hypothesis would come out in the same way as that of an endless life. This seems to me to make sense, precisely because it doesn't conflict with the insight that we cannot make any hypothesis concerning the number of objects (elements of facts). Its analysis only presupposes the infinite possibility of space and time and a *finite* number of elements of experience.

XIII

148 We might also ask: What is it that goes on when, while we've as yet no idea how a certain proposition is to be proved, we still ask 'Can it be proved or not?' and proceed to look for a proof? If we 'try to prove it', what do we do? Is this a search which is essentially unsystematic, and therefore strictly speaking *not a search at all*, or can there be some plan involved? How we answer this question is a pointer as to whether the as yet unproved--or as yet unprovable--proposition is senseless or not. For, in a very important sense, every significant proposition must teach us through its sense how we are to convince ourselves whether it is true or false. 'Every proposition says what is the case if it is true.' And with a mathematical proposition this 'what is the case' must refer to the way in which it is to be proved. Whereas--and this is the point--you cannot have a logical plan of search for a *sense* you don't know. The sense would have to be, so to speak, revealed to us: revealed from without--since it can't be obtained from the propositional sign alone--in contrast with its truth, where the proposition itself tells us how to look for its truth and compare the truth with it.

This amounts to asking: Does a mathematical proposition tie something down to a Yes or No answer? (i.e. precisely a sense.)

My explanation mustn't wipe out the existence of mathematical problems. That is to say, it isn't as if it were only certain that a mathematical proposition made sense when it (or its opposite) had been proved. (This would mean that its opposite would never have a sense (Weyl).) On the other hand, it could be that certain apparent problems lose their character as problems--the question as to Yes or No.

149 Is it like this: I need a new insight at each step in a proof? This is connected with the question of the individuality of each

number. Something of the following sort: Supposing there to be a certain general rule (therefore one containing a variable), I must recognize each time afresh that this rule may be applied *here*. No act of foresight can absolve me from this act of *insight* [†1]. Since the form to which the rule is applied is in fact different at every step.

A proof of relevance would be a proof which, while yet not proving the proposition [would show the form of a method to be followed in order to test such a proposition] [†2]. And just that could make such a proof possible. It wouldn't get to the top of the ladder since *that* requires that you pass every rung; but only show that the ladder leads in this direction. That is, there's no substitute for stepping on every rung, and whatever is equivalent to doing so must in its turn possess the same multiplicity as doing so. (There are no surrogates in logic.) Neither is an arrow a surrogate for going through all the stages towards a particular goal. This is also connected with the impossibility of an hierarchy of proofs.

Wouldn't the idea of an hierarchy mean that merely posing a problem would have to be already preceded by a proof, i.e. a proof that the question makes sense? But then I would say that a proof of sense must be a radically different sort of proof from one of a proposition's truth, or else it would in its turn presuppose yet another and we'd get into an infinite regress.

Does the question of relevance make sense? If it does, it must always be possible to say whether the axioms are relevant to this proposition or not, and in that case this question must always be decidable, and so a question of the *first* type has already been decided. And if it can't be decided, it's completely senseless.

What, apart from Fermat's alleged proof, drives us to concern ourselves with the formula $x^n + y^n = z^n \dots (F)$, is the fact that we never happen upon cardinal numbers that satisfy the equation; but that doesn't give the *slightest* support (probability) to the general theorem and so doesn't give us any good reason for concerning ourselves with the formula. Rather, we may look on it simply as a notation for a particular general form and ask ourselves whether syntax is *in any way at all* concerned with this form.

I said: Where you can't look for an answer, you can't ask either, and that means: Where there's no logical method for finding a solution, the question doesn't make sense either.

Only where there's a method of solution is there a problem (of course that doesn't mean 'Only when the solution has been found is there a problem').

That is, where we can only expect the solution from some sort of revelation, there isn't even a problem. A revelation doesn't correspond to any question.

It would be like wanting to ask about experiences belonging to a sense organ we don't yet possess. Our being given a new sense, I would call revelation.

Neither can we *look for* a new sense (sense-perception).

150 We come back to the question: In what sense can we *assert* a mathematical proposition? That is: what *would* mean nothing would be to say that I can only assert it if it's correct.--No, to be able to make an assertion, I must do so with reference to its sense, not its truth. As I've already said, it seems clear to me that I can assert a general proposition as much or as little as the equation $3 \times 3 = 9$ or $3 \times 3 = 11$.

It's almost unbelievable, the way in which a problem gets completely barricaded in by the wrong expressions which generation

upon generation throw up for miles around it, so that it's virtually impossible to get at it.

What makes understanding difficult is the misconception of the *general* method of solution as only an--incidental--expedient for deriving numbers satisfying the equation. Whereas it is in itself a clarification of the essence (nature) of the equation. Again, it isn't an incidental device for discovering an extension, it's an end in itself.

What questions can be raised concerning a form, e.g. $fx = gx$?--Is $fx = gx$ or not (x as a general constant)? Do the rules yield a solution of this equation or not (x as unknown)? Do the rules prohibit the form $fx = gx$ or not (x construed as a stop-gap)?

None of these cases admits of being tested empirically, and so extensionally.

Not even the last two, since I see that e.g., ' $x^2 = 4$ ' is permitted no less from $7^2 = 4$ than from $2^2 = 4$, and that $x^2 = -4$ is prohibited isn't shown me by $2^2 \neq -4$ in any different way from that by which $8^2 \neq -4$ shows it me. That is, in the particular case, I again see here only the rule.

The question 'Do any numbers satisfy the equation?' makes no sense, no more than does 'It is satisfied by numbers', or, of course, than 'It is satisfied by all (no) numbers'.

The important point is that, even in the case where I am given that $3^2 + 4^2 = 5^2$, I ought *not* to say ' $(\exists x, y, z, n) \cdot x^n + y^n = z^n$ ', since taken extensionally that's meaningless, and taken intensionally this doesn't provide a proof of it. No, in this case I ought to express only the first equation.

It's clear that I may only write down the general proposition (using general constants), when it is analogous to the proposition $25 \times 25 = 625$, and that will be when I know the rules for calculating with a and b just as I know

those for 6, 2 and 5. This illustrates

Page Break 174

precisely what it means to call a and b constants here--i.e. constant forms [†1].

Page 174

Is it like this: I can't use the word 'yields' while I am unaware of any method of solution, since *yields* refers to a structure that I cannot designate unless I am aware of it. Because the structure must be *represented*.

Page 174

Every proposition is the signpost for a verification.

Page 174

If I construe the word 'yields' in an essentially intensional way, then the proposition 'The equation E yields the solution a ' means nothing until the word 'yields' stands for a definite method. For it is precisely this which I wish to refer to.

Page Break 175

Page 175

I have here nothing other than the old case that I cannot say two complexes stand in a relation without using a logical mapping of the relation.

Page 175

'The equation yields a ' means: If I transform the equation in accordance with certain rules, I get a , just as the equation $25 \times 25 = 620$ says that I get 620 if I apply the rules for multiplication to 25×25 . But these rules must already be given to me before the word 'yields' has a meaning and before the question whether the equation yields a has a sense.

Page 175

Thus Fermat's proposition makes no *sense* until I can *search* for a solution to the equation in cardinal numbers.

Page 175

And 'search' must always mean: search systematically. Meandering about in infinite space on the look-out for a gold ring is no kind of search.

Page 175

You can only *search* within a system: And so there is necessarily something you *can't* search for [†1].

Page 175

151 We may only put a question in mathematics (or make a conjecture), where the answer runs: 'I must work it out'.

Page 175

But can't I also say this is the case of $1/3 = 0.\dot{3}$, where the result isn't an extension, but the formation of the inductive relationship?

Page 175

But even so, we must also have a clear idea of this inductive relationship if we are to expect it.

Page 175

That is: even here we still can't conjecture or expect in a void.

Page 175

What 'mathematical questions' share with genuine questions is simply that they can be answered.

Page Break 176

Page 176

If the $\dot{3}$ in $1/3 = 0.\dot{3}$ refers to a definite method, then 0.110 as connected with F means nothing, since a method is lacking here [†1].

Page 176

A law I'm unaware of isn't a law.

Page 176

A mathematical question must be as exact as a mathematical proposition.

Page 176

The question 'How many solutions are there to this equation?' is the holding in readiness of the general method for solving it. And that, in general, is what a question is in mathematics: the holding in readiness of a general

method.

Page 176

I need hardly say that where the law of the excluded middle doesn't apply, no other law of logic applies either, because in that case we aren't dealing with propositions of mathematics. (Against Weyl and Brouwer.)

Page 176

Wouldn't all this lead to the paradox that there are no difficult problems in mathematics, since, if anything is difficult, it isn't a problem?

Page 176

But it isn't like that: The difficult mathematical problems are those for whose solution we don't yet possess a *written* system. The mathematician who is looking for a solution then has a system in some sort of psychic symbolism, in images, 'in his head', and endeavours to get it down on paper. Once that's done, the rest is easy. But if he has *no kind* of system, either in written or unwritten

Page Break 177

symbols, then he can't *search* for a solution either, but at best can only grope around.--Now, of course you may find something even by random groping. But in that case you haven't searched for it, and, from a logical point of view, the process was synthetic; whereas searching is a process of analysis.

Page 177

Whatever one can tackle is a problem [\dagger 1].

Page 177

Only where there can be a problem can something be asserted.

Page 177

If I know the rules of elementary trigonometry, I can check the proposition $\sin 2x = 2 \sin x \cdot \cos x$, but not the proposition $\sin x = x - \frac{x^3}{3!} + \dots$. But that means that the sine function of elementary trigonometry and that of higher trigonometry are *different* concepts. If we give them the same name, we admittedly do so with good reason, since the second concept includes within itself the multiplicity of the first; but as far as the system of elementary trigonometry is concerned, the second proposition makes *no sense*, and it is of course senseless in this context to ask whether $\sin x = x$ --etc.

Page 177

152 Is it a genuine question if we ask whether it's possible to trisect an angle? And of what sort is the proposition and its proof that it's impossible with ruler and compasses alone?

Page 177

We might say, since it's impossible, people could never even have tried to look for a construction.

Page 177

Until I can *see* the larger system encompassing them both, I can't try to solve the higher problem.

Page 177

I can't ask whether an angle can be trisected with ruler and compasses, until I can see the system 'Ruler and Compasses' as embedded in a larger one, where the problem is soluble; or better, where the problem is a problem, where this question has a sense.

Page Break 178

Page 178

This is also shown by the fact that you *must* step outside the Euclidean system for a proof of the impossibility.

Page 178

A system is, so to speak, a world.

Page 178

Therefore we can't search for a system: What we *can* search for is the expression for a system that is given me in unwritten symbols.

Page 178

A schoolboy, equipped with the armoury of elementary trigonometry and asked to test the equation $\sin x = x$ --etc., simply wouldn't find what he needs to tackle the problem. If the teacher nevertheless expects a solution from him, he's assuming that the multiplicity of the syntax which such a solution presupposes is in some way or other present in a different form in the schoolboy's head--present in such a way that the schoolboy sees the symbolism of elementary trigonometry as a part of this unwritten symbolism and now translates the rest from an unwritten into a

written form.

Page 178

The system of rules determining a calculus thereby determines the 'meaning' of its signs too. Put more strictly: The form and the rules of syntax are equivalent. So if I change the rules--seemingly supplement them, say--then I change the form, the meaning.

Page 178

I cannot draw the limits of my world, but I can draw limits within my world. I cannot ask whether the proposition p belongs to the system S , but I can ask whether it belongs to the part s of S . So that I can locate the problem of the trisection of an angle within the larger system, but can't ask, within the Euclidean system, whether it's soluble. In what *language* should I ask this? in the Euclidean? But neither can I ask in Euclidean language about the possibility of bisecting an angle within the Euclidean system. For

Page Break 179

in this language that would boil down to a question about absolute possibility, and such a question is always nonsense.

Page 179

But there's nothing to be found here which we could call a hierarchy of types.

Page 179

In mathematics, we cannot talk of systems in general, but only *within* systems. They are just what we can't talk about. And so, too, what we can't search for.

Page 179

The schoolboy that lacked the equipment for answering the second question, couldn't merely not answer it, he couldn't even understand it. (It would be like the task the prince set the smith in the folk tale: Fetch me a 'Fiddle-de-dee'.)

Page 179

Every legitimate mathematical proposition must put a ladder up against the problem it poses, in the way that $12 \times 13 = 137$ does--which I can then climb if I choose.

Page 179

This holds for propositions of any degree of generality. (N.B. there is no ladder with 'infinitely many' rungs.)

Page 179

Now suppose I have two systems: I can't enquire after one system encompassing them both, since not only am I unable now to search for this system, but even in the event of one turning up that encompasses two systems analogous to the original ones, I see that I could never have looked for it.

Page 179

153 Proofs proving the same thing may be translated into one another, and to that extent are the same proof. The only proofs for which this doesn't hold are like: 'From two things, I infer that he's at home: first his jacket's in the hall, and also I can hear him whistling'. Here we have two independent ways of knowing. This proof requires grounds that come from outside, whereas a mathematical proof is an analysis of the mathematical proposition.

Page Break 180

Page 180

What is a proof of provability? It's different from the proof of proposition.

Page 180

And is a proof of provability perhaps the proof that a proposition makes sense? But then, such a proof would have to rest on *entirely different* principles from those on which the proof of the proposition rests. There cannot be an hierarchy of proofs!

Page 180

On the other hand there can't in any fundamental sense be such a thing as metamathematics. Everything must be of one type (or, what comes to the same thing, not of a type).

Page 180

Now, is it possible to show that the axioms are relevant to a proposition (i.e. prove it or its opposite), without actually bringing them to bear directly on it? That is, do we only know whether they are relevant when we've got there, or is it possible to know this at an earlier stage? And is the possibility of checking $36 \times 47 = 128$ a proof of this? It obviously makes sense to say 'I know how you check that', even before you've done so.

Page 180

Thus, it isn't enough to say that p is provable, what we must say is: provable according to a particular system.

Page 180

Further, the proposition doesn't assert that p is provable in the system S , but in *its own* system, the system of p . That p belongs to the system S cannot be asserted, but must show itself.

Page 180

You can't say p belongs to the system S ; you can't ask which system p belongs to; you can't search for the system of p . Understanding p means understanding its system. If p appears to go over from one system into another, then p has, in reality, changed its sense.

Page 180

Ramsey believed that what I call recognizing the system was nothing more than the application--perhaps unconscious--of a general mathematical proposition. So that if I know that the question of the correctness of $\sin 3a = 5 \cos a$ is decidable, I

Page Break 181

merely deduce that from the laws for $\sin(a + b)$ etc. But this isn't right: on the contrary, I derive it from the fact that there is such a law, not from how it runs.

Page 181

154 I could gather together numerical equations and equations using variables as follows: Transforming the left-hand side in accordance with certain rules either does or does not yield the right-hand side.

Page 181

But for this to be so, the two sides of the equation (N.B. of the *general* equation) must, so to speak, be *commensurable*.

Page 181

The classifications made by philosophers and psychologists are like those that someone would give who tried to classify clouds by their shapes.

Page 181

What a mathematical proposition says is always what its proof proves. That is to say, it never says more than its proof proves.

Page 181

If I had a method for distinguishing equations with a solution from those without, then in terms of this method the expression ' $(\exists x) \cdot x^2 = 2x$ ' would make sense.

Page 181

I can ask 'What is the solution of the equation $x^2 = 2x$?', but not 'Has it a solution?' For what would it look like for it to have none? A proposition has a sense only if I know what is the case if it is false.--But suppose the alternative case were something like the equation ' $(\exists x) \cdot x^2 - 2x - x(x - 2) = 0$ '? In that case at any rate, the proposition $(\exists x) \cdot x^2 = 2x$ would make sense and it would be proved by the fact that the rules don't allow us to reduce the two sides to one another. In reply to the question 'Is there a solution of the equation $x^n + ax^{n-1} + \dots + z = 0$?', we may always ask 'As opposed to what?'

Page 181

$25 \times 25 = 625$. What constitutes the system which shows me the commensurability in this case?

Page 181

Surely that multiplication of two numbers written in this form always gives me a number of the same form, and a rule for two

Page Break 182

numerical signs of this form decides whether they designate the same or different numbers.

Page 182

We could also characterize this idea as follows: 'It's impossible for us to discover rules of a new type that hold for a form with which we are familiar. If they are rules which are new to us, then it isn't the old form. The edifice of rules must be *complete*, if we are to work with a concept at all--*we cannot make any discoveries in syntax*--For, only the group of rules *defines* the sense of our signs, and any alteration (e.g. supplementation) of the rules means an alteration of the sense.

Page 182

Just as we can't alter the marks of a concept without altering the concept itself. (Frege)

Page 182

A system is a formal series, and it is precisely in the rules of the series that the iterations yielding its successive members are described.

Page 182

The negation of 'It is necessary that p holds for all numbers' is of course 'It is not necessary that...', not 'It is

necessary that not...'. But now we think: if it isn't *necessary* that p holds for all numbers, it's surely still possible. But this is where the fallacy lies, since we don't see that we've slipped into the extensional way of looking at things: the proposition 'It's possible--though not necessary--that p should hold for all numbers' is nonsense. For in mathematics '*necessary*' and '*all*' go together. (Unless we replace these idioms throughout by ones which are less misleading.)

Page 182

155 What kind of discovery was it, e.g., that Sheffer made when he showed that we can reduce all the truth-functions to $p|q$? Or the discovery of the method for extracting the cube root? What's going on when we have to resort to a dodge in Mathematics? (As when solving an equation or integrating.) Here it's like unravelling a knot. I can try out one way or another at random and

Page Break 183

the knot may get even more tangled or come undone. (Whatever happens, each operation is a permissible one and leads *somewhere*.)

Page 183

I want to say that finding a system for solving problems which previously could only be solved one by one by separate methods isn't merely discovering a more convenient vehicle, but is something completely new which previously we didn't have at all. The uniform method precisely isn't just the method for constructing an object, which is the same no matter how it was constructed. The method isn't a vehicle taking us to a place which is our real goal no matter how we arrive at it.

Page 183

That is to say: In my opinion, no *way* can be found in mathematics which isn't also a goal. You can't say: I already had all these results, now all I've done is find an even better way that leads to all of them. No: this way is a new place that we previously lacked. The new way amounts to a new system.

Page 183

Wouldn't this imply that we can't learn anything new about an object in mathematics, since, if we do, it is a new object?

Page 183

This boils down to saying: If I hear a proposition of, say, number theory, but don't know how to prove it, then I don't understand the proposition either. This sounds extremely paradoxical. It means, that is to say, that I don't understand the proposition that there are infinitely many primes, unless I know its so-called proof: when I learn the proof, I learn something *completely new*, and not just the way leading to a goal with which I'm already familiar.

Page 183

But in that case it's unintelligible that I should admit, when I've got the proof, that it's a proof of precisely *this* proposition, or of the induction meant by this proposition.

Page Break 184

Page 184

I want to say, it isn't the prose which is the mathematical proposition, it's the exact expression [\dagger 1].

Page 184

There can't be two independent proofs of one mathematical proposition.

Page 184

156 Unravelling knots in mathematics: Can someone *try* to unravel a knot which is subsequently shown to be impossible to untie? People succeeded in resolving the cubic equation, they *could not* have succeeded in trisecting an angle with ruler and compasses; people had been grappling with both these problems long before they knew how to solve the one and that the other was insoluble.

Page 184

Let's consider something that appears to be a knot, but is in reality made up of many loops of thread and perhaps also a few threads with loose ends. I now set someone the task of unravelling the knot. If he can see the arrangement of the threads clearly, he'll

Page Break 185

say 'That's not a knot and so there's no such thing as unravelling it'. If he can only see a jumble of threads, then he may try to untie it, pulling various ends at random, or actually making a few transformations that are the result of having a clear picture of some parts of the knot, even though he hasn't seen its structure as a whole.

Page 185

I would say here we may only speak of a genuine attempt at a solution *to the extent* that the structure of the

knot is seen clearly. To the extent that it isn't, everything is groping in the dark, since it's certainly possible that something which looks like a knot to me isn't one at all; (the best proof that I in fact had no method for searching for a solution). We can't compare what goes on here with what happens when I make a methodical search of a room for something, and so discover that it isn't there. For in this case I am searching for a possible state of affairs, not an impossible one.

Page 185

But now I want to say that the analogy with a knot breaks down, since I can have a knot and get to know it better and better, but in the case of mathematics I want to say it isn't possible for me to learn more and more about something which is already given me in my signs, it's always a matter of learning and designating something *new*.

Page 185

I don't see how the signs, which we ourselves have made for expressing a certain thing, are supposed to create problems for us.

Page 185

It's more like a situation in which we are gradually shown more and more of a knot or tangle, and we make ourselves a series of pictures of as much of it as we can see. We have no idea what the part of the knot not yet revealed to us is like and can't in any way make conjectures about this (say, by examining the pictures of the part we know already).

Page Break 186

Page 186

157 What did people discover when they found there was an infinity of primes? What did people discover when they realized there was an infinity of cardinals?--Isn't it exactly similar to the recognition--if that is what it is--that Euclidean Space is infinite, long after we have been forming propositions about the objects in this space.

Page 186

What is meant by an investigation of space?--For every mathematical investigation is a sort of investigation of space [†1]. It's clear that we can investigate the *things* in space--but space itself! (Geometry and Grammar always correspond with one another.)

Page 186

Let's remember that in mathematics, the signs themselves *do* mathematics, they don't describe it. The mathematical signs *are* like the beads of an abacus. And the beads are in space, and an investigation of the abacus is an investigation of space.

Page 186

What wasn't foreseen, wasn't foreseeable; for people lacked the system within which it could have been foreseen. (And would have been.)

Page 186

You can't write mathematics [†2], you can only do it. (And for that very reason, you can't 'fiddle' the signs in mathematics.)

Page 186

Suppose I wanted to construct a regular pentagon but didn't know how, and were now to make experiments at random, finally coming upon the right construction by accident: Haven't we here an actual case of a knot which is untied by trial and error? No, since if I don't understand this construction, as far as I'm concerned it doesn't even begin to be the construction of a pentagon.

Page 186

Of course I can write down the solution of a quadratic equation by accident, but I can't understand it by accident. The way I have

Page Break 187

arrived at it vanishes in what I understand. I then understand what I understand. That is, the accident can only refer to something purely external, as when I say 'I found that out after drinking strong coffee.' The coffee has no place in what I discovered.

Page 187

158 The discovery of the connection between two systems wasn't in the *same* space as those two systems, and if it had been in the same space, it wouldn't have been a discovery (but just a piece of homework).

Page 187

Where a connection is now known to exist which was previously unknown, there wasn't a gap before, something incomplete which has now been filled in!--(At the time, we weren't in a position to say 'I know this much

about the matter, from here on it's unknown to me.')

Page 187

That is why I have said there are no gaps in mathematics. This contradicts the usual view.

Page 187

In mathematics there is no 'not yet' and no 'until further notice' (except in the trivial sense that we haven't yet multiplied two 1,000-digit numbers together).

Page 187

An induction has a great deal in common with the multiplicity of a class (a finite class, of course). But all the same it isn't one, and now it is called an infinite class.--

Page 187

If, e.g., I say, 'If I know one whorl, I know the whole spiral', that strictly means: if I know the law of a spiral, that's in many respects analogous with the case in which I know a totality of whorls.--But naturally a 'finite' totality, since that's the only kind there is.--We can't now say: I agree it's in many ways analogous with a finite totality, but on the other hand it's completely analogous with an infinite one; that an induction isn't *completely* analogous with a totality is simply all we can say.

Page Break 188

Page 188

Mathematics cannot be incomplete; any more than a *sense* can be incomplete. Whatever I can understand, I must completely understand. This ties up with the fact that my language is in order just as it stands, and that logical analysis does not have to add anything to the sense present in my propositions in order to arrive at complete clarity. So that even the most unclear seeming proposition retains its previous content intact after the analysis and all that happens is that its grammar is made clear.

Page 188

159 But doesn't it still have to count as a question, whether there is a finite number of primes or not?--Once you have acquired this concept at all. For it certainly seems that the moment I'm introduced to the concept of a prime number, I can ask 'How many are there?' Just as I can ask 'How many are there?' straight off when I am given the concept 'man in this room'.

Page 188

If I am misled by this analogy, it can only be because the concept 'prime number' is given me in a completely different way from a genuine concept. For, what is the strict expression of the proposition '7 is a prime number'? Obviously it is only that dividing 7 by a smaller number always leaves a remainder. There cannot be a different expression for that, since we can't describe mathematics, we can only do it. (And that of itself abolishes every 'set theory'.)

Page 188

Therefore once I can write down the general form of prime number, i.e. an expression in which anything analogous to 'the number of prime numbers' is contained at all, then there is no longer a question of 'how many' primes there are, and until I can do this, I also can't put the question. For, I can't ask 'Does the series of primes *eventually* come to an end?' nor, 'Does another prime *ever* come after 7?'

Page 188

For since it was possible for us to have the phrase 'prime number' in ordinary language, even before there was the strict expression which so to speak admitted of having a number assigned

Page Break 189

to it, it was also possible for people to have wrongly formed the question how many primes there were. This is what creates the impression that previously there was a problem which is now solved. Verbal language seemed to permit this question both before and after, and so created the illusion that there had been a genuine problem which was succeeded by a genuine solution. Whereas in exact language people originally had nothing of which they could ask how many, and later an expression from which one could immediately read off its multiplicity.

Page 189

Thus I want to say: only in our verbal language (which in this case leads to a misunderstanding of logical form) are there in mathematics 'as yet unsolved problems' or the problem of the finite 'solubility of every mathematical problem'.

Page 189

160 It seems to me that the idea of the consistency of the axioms of mathematics, by which mathematicians are so haunted these days, rests on a misunderstanding.

Page 189

This is tied up with the fact that the axioms of mathematics are not seen for what they are, namely, propositions of syntax.

Page 189

There is no question as to provability, and in *that* sense no proof of provability either. The so-called proof of provability is an induction, to recognize which is to recognize a new system.

Page 189

A consistency proof can't be essential for the application of the axioms.

Page 189

A postulate is only the postulation of a form of expression. The 'axioms' are postulates of the form of expression.

Page 189

161 The comparison between a mathematical expedition and a polar expedition. There is a point in drawing this comparison, and it is a very useful one.

Page Break 190

Page 190

How strange it would be if a geographical expedition were uncertain whether it had a goal, and so whether it had any route whatsoever. We can't imagine such a thing, it's nonsense. But this is precisely what it is like in a mathematical expedition. And so perhaps it's a good idea to drop the comparison altogether.

Page 190

It would be an expedition, which was uncertain of *the space* it was in!

Page 190

How can there be conjectures in mathematics? Or better: what sort of thing is it that looks like a conjecture in mathematics? Such as making a conjecture about the distribution of primes.

Page 190

I might, e.g., imagine that someone is writing the primes in series in front of me without my knowing they are the primes--I might for instance believe he is writing down numbers just as they occur to him--and I now try to detect a law in them. I might now actually form an hypothesis about this number sequence, just as I could about any other sequence yielded by an experiment in physics.

Page 190

Now in what sense have I, by so doing, made an hypothesis about the distribution of primes?

Page 190

You might say that an hypothesis in mathematics has the value that it trains your thoughts on a particular object--I mean a particular region--and we might say 'we shall surely discover something interesting about these things'.

Page 190

The trouble is that our language uses each of the words 'question', 'problem', 'investigation', 'discovery' to refer to such basically different things. It's the same with 'inference', 'proposition', 'proof'.

Page 190

The question again arises, what kind of verification do I count as valid for my hypothesis? Or, can I--*faute de mieux*--allow an empirical one to hold for the time being, until I have a 'strict

Page Break 191

proof'? No. Until there is such a proof, there's no connection at all between hypothesis and the 'concept' of a prime number.

Page 191

The concept of a prime number is the general law by means of which I test whether a number is a prime number or not.

Page 191

Only the so-called proof establishes any connection between my hypothesis and the primes *as such*. And that is shown by the fact that--as I've said--until then, the hypothesis can be construed as one belonging purely to physics.--On the other hand, when we have supplied a proof, it doesn't prove what was conjectured at all, since I can't conjecture to infinity. I can only conjecture what can be confirmed, but experience can only confirm a finite number of conjectures and you can't conjecture the proof until you've got it--and not then either.

Page 191

The concept 'prime number' is the general form of investigation of a number for the relevant property; the concept 'composite' the general form of investigation for divisibility etc.

162 What kind of discovery did Sheffer make when he found that $p \vee q$ and $\sim p$ can be expressed by means of $p|q$? People had no method for looking for $p|q$, and if someone were to find one today, it wouldn't make any difference.

What was it we didn't know before the discovery? It wasn't anything that we didn't know, it was something with which we weren't acquainted.

You can see this very clearly if you imagine someone objecting that $p|p$ isn't at all the same as is said by $\sim p$. The reply, of course, is that it's only a question of the system $p|q$ etc. having the necessary multiplicity. Thus Sheffer found a symbolic system with the necessary multiplicity.

Does it count as looking for something, if I am unaware of Sheffer's system and say I would like to construct a system with only *one* logical constant? No!

Systems are certainly not all in *one* space, so that I could say:

there are systems with 3 and with 2 logical constants, and now I am trying to reduce the number of constants *in the same way*. There is no '*same way*' here.

We might also put it like this: the completely analysed mathematical proposition is its own proof.

Or like this: a mathematical proposition is only the immediately visible surface of a whole body of proof and this surface is the boundary facing us.

A mathematical proposition--unlike a genuine proposition--is *essentially* the last link in a demonstration that renders it visibly right or wrong.

We can imagine a notation in which every proposition is represented as the result of performing certain operations--transitions--on particular 'axioms' treated as bases. (Roughly in the same way as chemical compounds are represented by means of such names as 'trimethylamide' etc.)

With a few modifications, such a notation could be constructed out of the instructions with which Russell and Whitehead preface the propositions of *Principia Mathematica*.

A mathematical proposition is related to its proof as the outer surface of a body is to the body itself. We might talk of the body of proof belonging to the proposition.

Only on the assumption that there's a body behind the surface, has the proposition any significance for us.

We also say: a mathematical proposition is the last link in a chain of proof.

XIV

163 ' $a + (b + c) = (a + b) + c$ '... $A(c)$ can be construed as a basic rule of a system. As such, it can only be laid down, but not *asserted*, or denied (hence no law of the excluded middle). But I can apparently also regard the proposition as the result of a proof. Is this proof the answer to a question and, if so, which? Has it shown an assertion to be true and so its negation to be false?

But now it looks as though I cannot prove the proposition at all in the sense in which it is a basic rule of a system. Rather, I prove something about it.

This is tied up with the question whether you can deny $2 = 2$, as you can $2 \times 35 = 70$, and why you cannot deny a definition.

In school, children admittedly learn that $2 \times 2 = 4$, but not that $2 = 2$.

Page 193

If we want to see what has been proved, we ought to look at nothing but the proof.

Page 193

We ought not to confuse the infinite possibility of its application with what is actually proved. The infinite possibility of application is *not* proved!

Page 193

The most striking thing about a recursive proof is that what it alleges to prove is not what comes out of it.

Page 193

The proof shows that the form ' $a + (b + (c + 1)) = (a + b) + (c + 1)$ '... ' $A(c + 1)$ ' follows from the form 1) ' $A(c)$ '

in accordance with the rule 2) ' $a + (b + 1) = (a + b) + 1$ '... ' $A(1)$ '. Or, what comes to the same thing, by means of the rules 1) and 2) the form ' $a + (b + (c + 1))$ ' can be transformed into ' $(a + b) + (c + 1)$ '. This is the sum total of what is actually in the proof. Everything else, and the whole of the usual interpretation, lies in the possibility of its application. And the usual mistake, in

Page Break 194

confusing the extension of its application with what it genuinely contains.

Page 194

Of course, a definition is not something that I can deny. So it does not have a sense, either. It is a rule by which I can proceed (or have to proceed).

Page 194

I cannot negate the basic rules of a system.

Page 194

In Skolem's proof the ' c ' doesn't have any meaning *during* the proof, it stands for 1 or for what may perhaps come out of the proof, and *after* the proof we are justified in regarding it as some number or other. But it must surely have already meant something in the proof. If 1, why then don't we write '1' instead of ' c '? And if something else, what? [†1]

Page Break 195

Page 195

If we now suppose that I wish to apply the theorem to 5, 6, 7, then the proof tells me I am certainly entitled to do so. That is to say, if I write these numbers in the form $((1 + 1) + 1)$ etc., then I can recognize that the proposition is a member of the series of propositions that the final proposition of Skolem's chain presents me with. Once more, this recognition is not provable, but intuitive.

Page Break 196

Page 196

'Every symbol is what it is and not another symbol.'

Page 196

Can there be no proof which merely shows that every multiplication in the decimal system in accordance with the rules must yield a number of the decimal system? (So that recognizing the same system would thus after all depend on recognizing the truth of a mathematical proposition.)

Page 196

It would have to be analogous to a proof that by addition of forms $((1 + 1) + 1)$ etc. numbers of this form would always result. Now, can that be proved? The proof obviously lies in the rule for addition of such expressions, i.e. in the definition and in nothing else.

Page 196

Indeed, we might also reply to the question for which this proof is to provide the answer: Well, what *else* do you expect the addition to yield?

Page 196

164 A recursive proof is only a general guide to an arbitrary special proof. A signpost that shows every proposition of a particular form a particular way home. It says to the proposition $2 + (3 + 4) = (2 + 3) + 4$: 'Go in *this* direction (run through this spiral), and you will arrive home.'

Page 196

To what extent, now, can we call such a guide to proofs the proof of a general proposition? (Isn't that like wanting to ask: 'To what extent can we call a signpost a route?')

Yet it surely does justify the application of $A(c)$ to numbers. And so mustn't there, after all, be a legitimate transition from the proof schema to this expression?

I know a proof with endless possibility, which, e.g., begins with 'A(1)' and continues through 'A(2)' etc. etc. The recursive proof is the general form of continuing along this series. But it itself must still prove something since it in fact spares me the trouble of proving each proposition of the form 'A(7)'. But how can it

prove this proposition? It obviously points along the series of proofs

$$\begin{array}{c}
 \swarrow \quad \searrow \\
 a + (b + (\xi + d)) = (a + (b + \xi)) + d = ((a + b) + \xi) + d = (a + b) + (\xi + d) \\
 \swarrow \quad \searrow \\
 a + (b + ((\xi + d))) = (a + (b + (\xi + d))) + d = ((a + b) + (\xi + d)) + d = (a + b) + ((\xi + d) + d) \\
 \swarrow \quad \searrow
 \end{array}$$

That is a stretch of the spiral taken out of the middle.

ξ is a stop-gap for what only emerges in the course of the development.

If I look at this series, it may strike me that it is akin to the definition $A(1)$; that if I substitute '1' for 'c' and '1' for 'd', the two systems are the same.

In the proof, at any rate, what is to be proved is not the end of the *chain of equations*.

The proof shows the spiral form of the law.

But not in such a way that it comes out as the conclusion of the chain of inferences.

It is also very easy to imagine a popular introduction of the proof using 1, perhaps followed by dots to indicate what we are to look out for. It wouldn't in essence be any less strict. (For the peculiarity of the proof stands out even more clearly in this case.)

Let's imagine it like this. How does it then justify the proposition $A(c)$?

If one regards the proof as being of the same sort as the derivation of $(x + y)^2 = x^2 + 2xy + y^2$, then it proves the proposition 'A(c + 1)' (on the hypothesis 'A(c)', and so of the proposition I really want to prove). And justifies--on this assumption special cases such as $3 + (5 + (4 + 1)) = (3 + 5) + (4 + 1)$. It also has a generality, but not the one we desire. This generality does not lie

in the letters, but just as much in the particular numbers and consists in the fact that we can repeat the proof.

But how can I use the sign ' $f(a)$ ' to indicate what I see in the passage from $f(1)$ to $f(2)$? (i.e. the possibility of repetition.)

Neither can I prove that $a + (b + 1) = (a + b) + 1$
 is a special case of $a + (b + c) = (a + b) + c$:
 I must see it.

(No rule can help me here either, since I would still have to know what would be a special case of this general rule.)

This is the unbridgeable gulf between rule and application, or law and special case.

$A(c) [\dagger 1]$ is a definition, a rule for algebraic calculation. It is chosen in such a way that this calculation agrees with arithmetical calculation. It permits the same transition in algebraic calculation that holds for cardinal numbers, as may be seen in the recursive proof. Thus $A(c)$ is not the result of a proof, it so to speak runs parallel with it.

What we gather from the proof, we cannot represent in a proposition at all and of course for the same reason we can't deny it either.

But what about a definition like $A(1) [\dagger 2]$? This is not meant as a rule for algebraic calculation, but as a device for explaining arithmetical expressions. It represents an *operation*, which I can apply to an arbitrary pair of numbers.

165 The correct expression for the associative law is not a proposition, but precisely its 'proof', which admittedly doesn't state the law, but shows it. And at this point it becomes clear that we cannot

deny the law, since it doesn't figure in the form of a proposition at all. We could of course deny the individual equations of the law, but would not thereby deny the law: that *eludes* affirmation and denial.

To know that you can prove something is to have proved it.

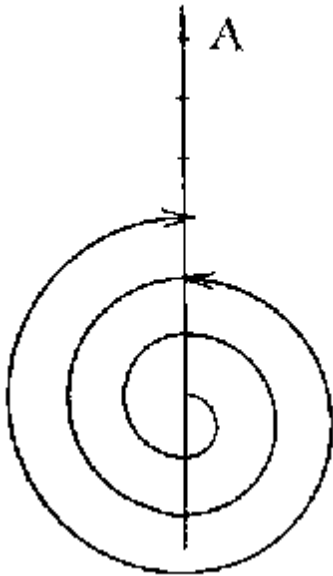

$7 + (8 + 9) = (7 + 8) + 9$. How do I know that this is so, without having to give a particular proof of it? And do I know *just as well* as if I had given a complete derivation of it? Yes!--Then that means it really is proved. What's more, in that case it cannot have a still *better* proof; say, by my carrying out the derivation as far as this proposition itself. So it must be possible for me to say after running through one turn of the spiral 'Stop! I don't need any more, I can already see how it goes on', and then every higher step must be purely superfluous and doesn't make the matter clearer. If I draw all the whorls of the spiral as far as my point, I cannot see that the spiral leads to it any better than if I draw only *one*. It is only that each shows the same thing in a different form. I can so to speak blindly follow the spiral that has been completely drawn in and arrive at my point, whereas the *one* whorl which has been drawn has to be interpreted in a particular way for me to perceive that, if continued, it leads to the point A.

That is to say: from the proof for $6 + (7 + 8) = (6 + 7) + 8$ which has been completely worked out, I can extract the same as from the one which only describes one 'whorl', but in a different way. And

at any rate the *one* whorl *in conjunction with the numerical forms* of the given equation is a complete proof of this equation. It's as though I were to say: 'You want to get to the point A? Well, you can get *there* along *this* spiral.'

When we teach someone how to take his first step, we thereby enable him to go any distance.

Page 200

166 As the immediate datum is to a proposition which it verifies, so is the arithmetical relation we see in the structure to the equation which it verifies.

Page 200

It is the real thing, not an expression for something else for which another expression could also be substituted. That is, it is not a symptom of something else, but the thing itself.

Page 200

For that is how it is usually construed (i.e. in the wrong way). One says an induction is a sign that such and such holds for all numbers. But the induction isn't a sign for anything but itself. If there were yet something besides the induction, for which *it* was a sign, this something would have to have its specific expression which would be nothing but the complete expression for this something.

Page 200

And this conception is then developed into the idea that the algebraic equation tells us what we see in the arithmetical induction. For that, it would have to have the same multiplicity as what it describes.

Page 200

How a proposition is verified is what it says. Compare the generality of genuine propositions with generality in arithmetic. It is differently verified and so is of a different kind.

Page 200

The verification is not *one* token of the truth, it is *the* sense of the proposition. (Einstein: How a magnitude is measured is what it is.)

Page 200

Indeed Russell has really already shown by his theory of descriptions, that you can't get a knowledge of things by sneaking up on

Page Break 201

them from behind and it can only *look* as if we knew more about things than they have shown us openly and honestly. But he has obscured everything again by using the phrase 'indirect knowledge'.

Page 201

167 An algebraic schema derives its sense from the way in which it is applied. So this must always be behind it. But then so must the inductive proof, since that justifies the application.

Page 201

An algebraic proposition is just as much an equation as $2 \times 2 = 4$, it is only applied differently. Its relation to arithmetic is different. It deals with the substitutability of other parts of speech.

Page 201

That is to say, an algebraic equation as an equation between real numbers is, *to be sure*, an arithmetical equation, since something arithmetical lies behind it. Only it lies behind the *algebraic* equation in a different way from the way it lies behind $1 + 1 = 2$.

Page 201

An induction doesn't prove the algebraic proposition, since only an equation can prove an equation. But it justifies the setting up of algebraic equations from the standpoint of their application to arithmetic.

Page 201

That is, it is only through the induction that they gain their sense, not their truth.

Page 201

For this reason, what can no longer be reduced to other equations, and can only be justified by induction, is a *stipulation*.

Page 201

Which is connected with the fact that in the application of this algebraic proposition I cannot appeal to it, but once again only to the induction.

Page 201

Hence these last equations can't be denied--i.e. there is no arithmetical content corresponding to their negation.

Page 201

Through them alone the algebraic system becomes applicable to numbers.

Page 201

And so in a particular sense they are certainly the expression of

Page Break 202

something arithmetical, but as it were the expression of an arithmetical *existence*.

Page 202

They alone make algebra into clothing for arithmetic--and are therefore arbitrary to the extent that no one compels us to use algebra in this way. They fit algebra on to arithmetic.

Page 202

And while it is wearing these clothes, it can move about in them.

Page 202

They are not the expression of something computable and to that extent are stipulations.

Page 202

Can someone who sees these stipulations learn something from them, in arithmetic? And, if so, what?--Can I learn an arithmetical state of affairs, and, if so, which?

Page 202

A stipulation is more like a name than like a proposition.

Page 202

You can only prove those propositions whose truth you can enquire into. 'Is it so or not?' 'I will prove to you it *is so*.'

Page 202

An induction is related to an algebraic proposition not as a proof is to what is proved, but as what is designated to a sign.

Page 202

The system of algebraic propositions corresponds to a *system* of inductions.

Page 202

168 A proof by induction, if it were a proof, would be a proof of generality, not a proof of a certain property of all numbers.

Page 202

We can only ask from a standpoint from which a question is possible. From which a doubt is possible.

Page 202

If one wanted to ask about $A(c)$, it wouldn't strictly speaking be the induction that answered us, but the humiliating feeling that we

Page Break 203

could only arrive at the thought of this equation by way of the induction.

Page 203

If we ask 'Does $a + (b + c) = (a + b) + c$?', what could we be after? Taken purely algebraically, the question means nothing, since the answer would be: 'Just as you like, as you decide.' Neither can the question mean 'Does this hold for all numbers?', it can only ask what the induction says: it, however, says nothing at all to us.

Page 203

We cannot ask about that which alone makes questions possible at all.

Page 203

Not about what first gives the system a foundation.

Page 203

That some such thing must be present is clear.

Page 203

And it is also clear that in algebra this first thing must present itself as a rule of calculation, which we can then use to test the other propositions.

Page 203

An algebraic proposition always gains only arithmetical significance if you replace the letters in it by numerals, and then always only *particular* arithmetical significance.

Page 203

Its generality doesn't lie in itself, but in the possibility of its correct application. And for that it has to keep on having recourse to the induction.

Page 203

That is, it does not assert its generality, it does not express it; the generality is, rather, shown in the formal relation to the substitution, which proves to be a term of the inductive series.

Page 203

$(\exists 24x) \cdot \phi x \cdot (\exists 18x) \cdot \psi x \cdot \text{Ind} : \supset : (\exists 24 + 18x) \cdot \phi x \vee \psi x$. How do I know that this is so, unless I have

introduced the concept of addition for the context of this application? I can only arrive at this proposition by induction. That is to say, corresponding to the general proposition--or rather, the tautology-- $(\exists nx) \cdot \phi x \cdot (\exists mx) \cdot \psi x \cdot \text{Ind}: \supset (\exists n + mx) \cdot \psi x \vee \psi x$, there is an induction, and this induction is the proof of the above proposition $(\exists 24x) \cdot \text{etc.}$, even before we have actually worked out $24 + 18$ and have tested whether it is a tautology.

Page Break 204

Page 204

To *believe* Goldbach's Conjecture, means to believe you have a proof of it, since I can't, as it were, believe it *in extenso*, because that doesn't mean anything, and you cannot imagine an induction corresponding to it until you have one.

Page 204

If the proof that every equation has a root is a recursive proof, then that means the Fundamental Theorem of Algebra isn't a genuine mathematical *proposition* [†1].

Page 204

169 If I want to know what ' $1/3 = 0.\dot{3}$ ' means, it's a relevant question to ask 'How can I know that?' For the proof comes as a reply to this 'how?', and more than is shown by this proof I certainly do not know.

Page 204

It is clear that every multiplication in the decimal system has a solution and therefore that one can prove any arithmetical equation of the form $a \times b = c$ or prove its opposite. What would a proof of this provability look like? It is obviously nothing further than a clarification of the symbolism and an exhibition of an induction from which it can be seen what sort of propositions the ladder leads to.

Page 204

I cannot deny the *generality* of a general arithmetical proposition.

Page 204

Isn't it only this generality that I cannot reflect in the algebraic proposition?

Page 204

An equation can only be proved by reducing it to equations.

Page 204

The last equations in this process are definitions.

Page 204

If an equation can't be reduced to other equations, then it is a definition.

Page 204

An induction cannot justify an equation.

Page 204

Therefore, e.g. the introduction of the notation $\dot{3}$ cannot refer to the induction whose sign it appears to be. The relation must be similar to that of 'A(c)' to its proof by induction.

Page Break 205

Page 205

Or better, it certainly refers to the bare facts of the induction, but not to the generality, which is its true sense.

Page Break 206

XV

Page 206

170 The theory of aggregates attempts to grasp the infinite at a more general level than a theory of rules. It says that you can't grasp the actual infinite by means of arithmetical symbolism at all and that therefore it can only be described and not represented. The description would encompass it in something like the way in which you carry a number of things that you can't hold in your hands by packing them in a box. They are then invisible but we still know we are carrying them (so to speak, indirectly). The theory of aggregates buys a pig in a poke. Let the infinite accommodate itself in this box as best it can.

Page 206

With this there goes too the idea that we can use language to describe logical forms. In a description of this sort the structures and e.g. correlations etc., are presented in a package, and so it does indeed look as if one could talk about a structure without reproducing it in the proposition itself. Concepts which are packed up like this and so whose structures are not recognisable may, to be sure, be used, but they always derive their meaning from

definitions which package the concepts in this way; and if we trace our way back through these definitions the concepts are then unpacked again and so are present in their structure.

Page 206

This is what Russell does with R^* ; he wraps the concept up in such a way that its form disappears.

Page 206

The point of this method is to make everything amorphous and treat it accordingly.

Page 206

If in logic a question can be answered (1) generally and (2) in particular, the particular answer must always show itself to be a special case of the general answer; put differently: the general case must always include the particular as a possibility.

Page Break 207

Page 207

A case of this is the calculation of a limit with δ and ν , which must include the number system of the particular computation.

Page 207

There must be a determinate way for translating the general form and the particular form into one another.

Page 207

171 Any proof of the continuity of a function must relate to a numerical scale--a number system.

Page 207

For if I say, 'Given any ν there is a δ for which the function is less than ν ', I am *ipso facto* referring to a general arithmetical criterion that indicates when $\phi(\delta)$ is less than ν .

Page 207

It is impossible that what in the nature of this case comes to light when calculating the function--namely, the numerical scale should be allowed to disappear in the general treatment.

Page 207

If the numerical system belongs to the essence of number, then the general treatment cannot do away with it.

Page 207

And if, therefore, the notation of the numerical system reflects the essence of number, then this essential element must also find its way into the general notation. In this way the general notation acquires the structure of the numbers.

Page 207

If, in the nature of the case, I cannot write down a number independently of a number system, that must also be reflected in the general treatment of number.

Page 207

A number system is not something inferior--like a Russian abacus--that is only of interest to elementary schools, while the higher, general discussion can afford to disregard it.

Page 207

The Cretan liar paradox could also be set up with someone writing the proposition: 'This proposition is false'. The demonstrative takes over the role of the 'I' in 'I'm lying'. The basic mistake

Page Break 208

consists, as in the previous philosophy of logic, in assuming that a word can make a sort of allusion to its object (point at it from a distance) without necessarily going proxy for it.

Page 208

So the question would really be: Can the continuum be described? As Cantor and others tried to do.

Page 208

A form cannot be described: it can only be presented.

Page 208

Dedekind's definition of an infinite set is another example of an attempt to describe the infinite, without *presenting* it.

Page 208

It would be like describing an illness by the external symptoms we know always accompany it. Only in this case there is a connection which isn't formal in nature.

Page 208

172 'The highest point of a curve' doesn't mean 'the highest point among all the points of the curve'--after all, we don't see these--it is a specific point yielded by the curve. In the same way the maximum of a function isn't the

largest value among all its values (that's nonsense, save in the case of finitely many, discrete points), it's a point yielded by a law and a condition; which, to be sure, is higher than any other point taken at random (*possibility*, not reality). And so also the point of intersection of two lines isn't the common member of two classes of points, it's the meeting of two laws. As indeed is perfectly clear in analytic geometry.

Page 208

The maximum of a function is susceptible of an intensional explanation. The highest point of a curve is admittedly higher than any other point taken at random, but I don't find it by sifting through the points of the curve one by one, looking for a yet higher one.

Page 208

Here again it is grammar which, as always in the sphere of the infinite, is playing tricks on us.

Page Break 209

Page 209

We say 'the highest point of the curve'. But that can't mean 'the highest point of all the points in the curve' in the sense in which we talk of the largest of these three apples, since we don't have all the points of the curve before us--in fact that's a nonsense expression.

Page 209

It's the same defect in our syntax which presents the proposition 'The apple may be divided into two parts' as of the same form as 'a length may be divided without limit', with the result that we can apparently say in both cases, 'Let's suppose the possible division to have been carried out'.

Page 209

But in truth the expressions 'divisible into two parts' and 'divisible without limit' have completely different forms.

Page 209

This is, of course, the same case as the one in which someone operates with the word 'infinite' as if it were a number word; because, in everyday speech, both are given as answers to the question 'How many?'

Page 209

The curve exists, independently of its individual points. This also finds expression in the fact that I *construct* its highest point: that is, derive it from a law and not by examining individual points.

Page 209

We don't say 'among *all* its points, there is only one at which it intersects the straight line'; no, we only talk about *one* point.

Page 209

So to speak, about one that runs along the straight line, but not about one among all the points of the line.

Page 209

The straight line isn't *composed* of points.

Page 209

173 But then what would a correct, as opposed to an amorphous explanation of R^* be like? Here I do need ' $(n)...$ '. In this case, this expression seems to be admissible.

Page 209

But, to be sure, ' $(\exists x) \cdot \phi x$ ' also says 'There is a number of x satisfying ϕx ', and yet the expression ' $(\exists x) \cdot \phi x$ ' can't be taken to presuppose the totality of all numbers.

Page 209

Ramsey's explanation of infinity also is nonsense for the same reason, since ' $(n):(\exists nx) \cdot \phi x$ ' would presuppose that we were given

Page Break 210

the actual infinite and not merely the unlimited possibility of going on [$\dagger 1$].

Page 210

But is it inconceivable that I should know someone to be my ancestor without having *any* idea at what remove, so that *no* limits would be set to the number of people in between [$\dagger 2$].

Page 210

But how would we put the proposition: ' ϕ is satisfied by the same number of objects as ψ '? One would suppose: ' $(\exists n):(\exists nx) \cdot \phi x \cdot (\exists nx) \cdot \psi x$ '.

Page 210

Brouwer is right when he says that the properties of his pendulum number are incompatible with the law of the excluded middle. But, saying this doesn't reveal a peculiarity of propositions about infinite aggregates. Rather, it

is based on the fact that logic presupposes that it cannot be *a priori*--i.e. logically--impossible to tell whether a proposition is true or false. For, if the question of the truth or falsity of a proposition is *a priori* undecidable, the consequence is that the proposition loses its sense and the consequence of this is precisely that the propositions of logic lose their validity for it.

Page 210

Just as in general the whole approach that if a proposition is valid for one region of mathematics it need not necessarily be valid for a second region as well, is quite out of place in mathematics, completely contrary to its essence. Although these authors hold

Page Break 211

just this approach to be particularly subtle, and to combat prejudice.

Page 211

Mathematics is ridden through and through with the pernicious idioms of set theory. *One* example of this is the way people speak of a line as composed of points. A line is a law and isn't composed of anything at all. A line as a coloured length in visual space can be composed of shorter coloured lengths (but, of course, not of points). And then we are surprised to find, e.g., that 'between the everywhere dense rational points' there is still room for the irrationals! What does a construction like that for $\sqrt{2}$ show? Does it show how there is yet room for this point in between all the rational points? It merely shows that the point *yielded* by the construction is *not rational*.

Page 211

And what corresponds to this construction and to this point in arithmetic? A sort of number which manages *after all* to squeeze in between the rational numbers? A law that is not a law of the nature of a rational number.

Page 211

The Dedekind cut proceeds as if it were clear what was meant when one says: There are only three cases: either R has a last member and L a first, or, etc. In truth none of these cases can be conceived (or imagined).

Page 211

174 Set theory is wrong because it apparently presupposes a symbolism which doesn't exist instead of one that does exist (is alone possible). It builds on a fictitious symbolism, therefore on nonsense.

Page 211

There is no such thing as an hypothesis in logic.

Page 211

When people say 'The set of all transcendental numbers is greater than that of algebraic numbers', that's nonsense. The set is of a different kind. It isn't 'no longer' denumerable, it's simply not denumerable!

Page Break 212

Page 212

The distribution of primes would then for once provide us with something in logic that a god could know and we couldn't. That is to say, there would be something in logic that could be known, but not by us.

Page 212

That there is a process of solution is something that cannot be asserted. For, were there none, the equation, as a general proposition, would be nonsensical.

Page 212

We can assert anything which can be checked in practice.

Page 212

It's a question of the possibility of checking.

Page 212

If someone says (as Brouwer does) that for $(x) \bullet f_1x = f_2x$, there is, as well as yes and no, also the case of undecidability, this implies that '(x)...' is meant extensionally and we may talk of the case in which all x happen to have a property. In truth, however, it's impossible to talk of such a case at all and the '(x)...' in arithmetic cannot be taken extensionally.

Page 212

We might say, 'A mathematical proposition is a pointer to an insight'. The assumption that no insight corresponded to it would reduce it to utter nonsense.

Page 212

We cannot *understand* the equation unless we recognize the connection between its two sides.

Page 212

Undecidability presupposes that there is, so to speak, a subterranean connection between the two sides; that

the bridge *cannot* be made with symbols.

Page 212

A connection between symbols which exists but cannot be represented by symbolic transformations is a thought that cannot be thought. If the connection is there, then it must be possible to see it.

Page 212

For it *exists* in the same way as the connection between parts of visual space. It isn't a *causal* connection. The transition isn't

Page Break 213

produced by means of some dark speculation different in kind from what it connects. (Like a dark passage between two sunlit places.)

Page 213

Of course, if mathematics were the natural science of infinite extensions of which we can never have exhaustive knowledge, then a question that was in principle undecidable would certainly be conceivable.

Page 213

175 Is there a sense in saying: 'I have as many shoes as the value of a root of the equation $x^3 + 2x - 3 = 0$ '? Even if solving it were to yield a positive integer?

Page 213

For, on my view, we would have here a notation in which we cannot immediately tell sense from nonsense.

Page 213

If one regards the expression 'the root of the equation $\phi x = 0$ ' as a Russellian description, then a proposition about the root of the equation $x + 2 = 6$ must have a different sense from one saying the same about 4.

Page 213

I cannot use a proposition before knowing whether it makes sense, whether it is a proposition. And this I don't know in the above case of an unsolved equation, since I don't know whether cardinal numbers correspond to the roots in the prescribed manner. It is clear that the proposition in the given case becomes nonsense and not false (not even a contradiction), since 'I have n shoes and $n^2 = 2$ ' is obviously tantamount to 'I have $\sqrt{2}$ shoes'.

Page 213

But I can establish this--or at any rate it can be established--if we only look at the signs. But I mustn't chance my luck and incorporate the equation in the proposition, I may only incorporate it if I know that it determines a cardinal number, for in that case it is simply a different notation for the cardinal number. Otherwise, it's just like throwing the signs down like so many dice and leaving it to chance whether they yield a sense or not.

Page Break 214

Page 214

$(x + y)^2 = x^2 + y^2 + 2xy$ is correct in the same sense as $2 \times 2 = 4$.

Page 214

And $2 + n = 1$ (where n is a cardinal number) is just as wrong as $2 + 3 = 1$ and $2 + n \neq 1$ as correct as the above.

Page 214

176 What makes one dubious about a purely internal generality is the fact that it can be refuted by the occurrence of a single case (and so by something extensional).

Page 214

But what sort of collision is there here between the general and the particular proposition? The particular case refutes the general proposition from within, not in an external way.

Page 214

It attacks the internal proof of the proposition and refutes it thus--not in the way that the existence of a one-eyed man refutes the proposition 'Every man has two eyes'.

Page 214

' $(x) \cdot x^2 = x + x$ ' seems to be false because working out the equation gives $x = \begin{Bmatrix} 0 \\ 2 \end{Bmatrix}$ and not that the two sides cancel out. Trying the substitution $x = 3$, say, also yields the general result-- $(\exists x) \cdot x^2 \neq 2x$ --and so must, to the extent that its result tallies with that of the general solution, itself tally with the general method.

Page 214

If the equation $x^2 + 2x + 2 = 0$ yields, by applying the algebraic rules, $x = -1 \pm \sqrt{-1}$, that is quite in order so long as we don't require the rules for x to accord with the rules for real numbers. In that case the outcome of the algebraic calculation means that the equation has no solution.

My difficulty is: When I solve equations in the real, rational or whole number domain by the appropriate rules, in certain cases I arrive at apparent nonsense. Now, when that happens: am I to say this proves that the original equation was nonsense? Which would mean I could only see whether it was sense or nonsense after I had finished applying the rules?! Isn't what we have to say, rather: The result of the apparently nonsensical equation does

after all show something about the general form, and does indeed establish a connection between the forbidden equation and equations which have a normal solution. After all, the solution always does show the distance of the abnormal solution from a normal one. If, e.g., $\sqrt{-1}$ is the result, I at least know that $\sqrt{-1+1}$ would be a normal root. The continuity, the connection with the normal solution, has not been disrupted. Would this imply that in the concept of the real numbers as we represent it in our symbolism and its rules, the concept of the imaginary numbers is already prefigured?

That would amount to roughly the same thing as saying of a straight line g that it is a distance a away from cutting the circle, instead of simply saying it doesn't cut it.

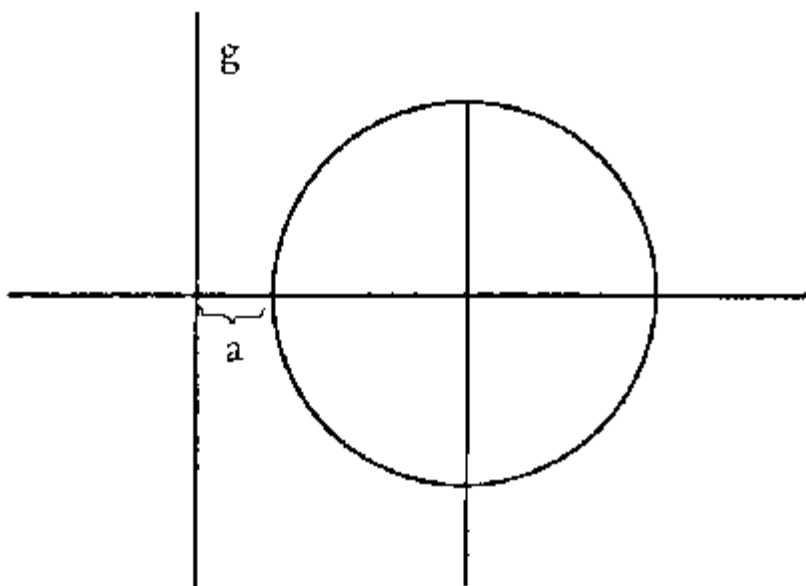

One might say 'It fails to intersect it by a certain amount' and this would represent the continuity with normal intersection. 'It misses it by a certain amount.'

The difference between the two equations $x^2 = x \cdot x$ and $x^2 = 2x$ isn't one consisting in the extensions of their validity.

I can, it is true, define $m > n$ as $(\exists x) \cdot n + x = m$, but I only know whether $x = m - n$ yields a number if I know the rule for subtraction, and in this context this does duty for the rule for determining greater and less. Thus formulated, this rule runs: m is greater than n , if, according to the rule for subtraction, $m - n$ yields a number.

XVI

177 What makes it apparent that space is not a collection of points, but the realization of a law?

It seems as though we should have first to erect the entire structure of space without using propositions; and then one may form all the correct propositions within it.

In order to represent space we need--so it appears to me--something like an expansible sign.

A sign that makes allowance for an interpolation, similar to the decimal system.

The sign must have the multiplicity and properties of space.

Page 216

The axioms of a geometry are not to include any truths.

Page 216

We can be sure of getting the correct multiplicity for the designations if we use analytic geometry.

Page 216

That a point in the plane is represented by a number-pair, and in three-dimensional space by a number-triple, is enough to show that the object represented isn't the point at all but the point-network.

Page 216

178 The geometry of visual space is the syntax of the propositions about objects in visual space.

Page 216

The axioms--e.g.--of Euclidean geometry are the disguised rules of a syntax. This becomes very clear if you look at what corresponds to them in analytic geometry.

Page 216

You could imagine the constructions of Euclidean geometry actually being carried out, say by using the edges of bodies as straight lines and the surfaces as planes. The axiom--for instance--that a

Page Break 217

straight line can be drawn through any two points has here the clear sense that, although no straight line *is* drawn between any 2 arbitrary points, it is *possible* to draw one, and that only means that the proposition 'A straight line passes through these points' makes *sense*. That is to say, Euclidean geometry is the syntax of assertions about objects in Euclidean space. And these objects are not lines, planes and points, but *bodies*.

Page 217

How are the equations of analysis connected with the results of spatial measurements? I believe, in such a way that they (the equations) fix what is to count as an accurate measurement and what as an error.

Page 217

One could almost speak of an external and an internal geometry. Whatever is arranged in visual space stands in this *sort* of order *a priori*, i.e. in virtue of its logical nature, and geometry here is simply grammar. What the physicist sets into relation with one another in the geometry of physical space are instrument readings, which do not differ in their *internal* nature whether we live in a linear space or a spherical one. That is to say, it isn't an investigation of the logical properties of these readings that leads the physicist to make an assumption about the nature of physical space, but the facts that are derived from them.

Page 217

The geometry of physics in this sense doesn't have to do with possibility, but with the facts. It is corroborated by facts: in the sense, that is, in which a *part* of an hypothesis is corroborated.

Page 217

Comparison between working with an adding machine and measuring geometrical structures: In such measurement, do we perform an experiment, or is the situation here the same as in the case of the adding machine, where we only establish internal relations and the physical result of our operations proves nothing?

Page 217

In visual space, of course, there is no such thing as a geometrical experiment.

Page Break 218

Page 218

I believe this is where the main source of misunderstanding about the *a priori* and the *a posteriori* in geometry lies.

Page 218

The question is, in what sense can the results of measurement tell us something concerning *that* which we also see.

Page 218

What about the proposition 'The sum of the angles of a triangle is 180° '? At any rate, it doesn't give the appearance of a proposition of syntax.

Page 218

The proposition 'Vertically opposite angles are equal' means that if they turn out to be different when they are measured, I shall declare the measurement to be in error; and 'The sum of the angles of a triangle is 180° ' means that, if the sum doesn't turn out to be 180° when measured, I shall assume an error in the measurement. In this way, the proposition is a postulation concerning the way to describe the facts: and so a proposition of syntax.

Page 218

There is obviously a method for constructing a straight ruler. This method involves an ideal: I mean, an approximation procedure with unlimited *possibility*, for it is simply this procedure which *is* the ideal.

Page 218

Or better: Only if it is a procedure with unlimited possibility, can (not must) the geometry of this procedure be Euclidean.

Page 218

Euclidean geometry doesn't presuppose *any method for measuring* angles and lengths, it no more says when two angles are to be counted as equal, than probability theory says when two cases are to be counted as equally likely. If a particular method of measurement is now adopted--say one with metal rulers--the question then arises whether the results of measurements carried out in this way yield Euclidean results.

Page 218

179 Imagine we are throwing a two-sided die, such as a coin. I now want to determine a point of the interval A B by continually tossing the coin, and always bisecting the side prescribed by the

Page Break 219

throw: say: heads means I bisect the right-hand interval, tails the left-hand one

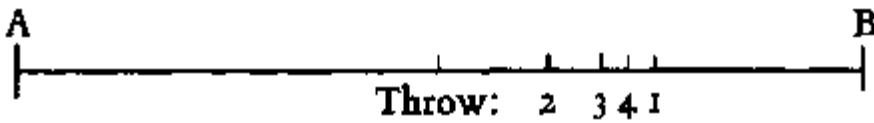

Page 219

Now, does it describe the position of a point of the interval if I say 'It is *the* point which is approached indefinitely by bisection as prescribed by the endless tossing of the coin'?

Page 219

In this way I can approach without limit every point of the interval by continual bisection, and with infinitely fine eyesight and instruments *every* stage of the bisection would be determined. (The infinitely fine eyesight doesn't introduce a vicious circle.)

Page 219

Now, could we call an infinite series of digits which was thus determined an infinite decimal? That is, does this geometrical process define a *number*?

Page 219

The geometrical process does not involve a vicious circle, since only an infinite possibility is presupposed by it, not an infinite reality. (Lines and points being given by the boundaries of coloured surfaces.)

Page 219

To what extent can you say that I have in this way really divided the rationals into two classes? In fact, of course, this division is never accomplished. But I have a *process* by means of which I approach such a division indefinitely? I have an unlimited process, whose results as such don't lead me to the goal, but whose unlimited possibility is itself the goal. But what does this limitlessness consist in--don't we here have once more merely an operation and the *ad infinitum*? Certainly. But the operation is not an arithmetical one.

Page 219

(And the point which I call to my aid in my endless construction can't be given arithmetically at all.)

Page 219

At this point many people would say: it doesn't matter that the

Page Break 220

method was geometrical, it is only the resulting *extension* itself that is our goal. But, then, do I have this?

Page 220

What is the analogue in arithmetic to the geometrical process of bisection? It must be the converse process: that of determining a point by a law. (Instead of the law by a point.)

Page 220

It would in fact correspond to the endless process of choosing between 0 and 1 in an infinite binary

expansion **0000** **1111** ... *ad inf.* The law here would run 'You must put a 1 or a 0 in succession *ad inf.*, each yields a law, each a different one.'

Page 220

But that doesn't imply that a law would be given *in that* I say 'In every case throw either heads or tails.' Of course, in this way I would necessarily obtain a special case of the general law mentioned, but wouldn't know from

the outset which. No law of succession is described by the instruction to toss a coin.

Page 220

What is arithmetical about the process of tossing the coin isn't the actual result, it is its infinite indefiniteness. But that simply does not *define* a number [†1].

Page 220

If I adumbrate a law thus: '0.001001001... *ad inf.*', what I want to show is not the finite series as a specimen of a section of an infinite series, but rather the kind of regularity to be perceived in it. But in $0.\overset{000}{111} \dots$ I don't perceive *any* law--on the contrary, precisely that a law is absent. Save, say, the law that the results of the specific laws are written with '0' and '1' and no other signs.

Page 220

The rules of combination for 0 and 1 yield the totality of *all* finite

Page Break 221

fractions. This would be an infinite extension, in which the infinite extension of fractions 0.1, 0.101, 0.10101 etc. *ad inf.* would also have to occur and, generally, all the irrational numbers.

Page 221

What is it like if someone so to speak checks the various laws by means of the set of finite combinations?

Page 221

The results of a law run through the finite combinations, and hence the laws are complete as far as their extensions are concerned, once *all* the finite combinations have been gone through.

Page 221

Neither may we say: Two laws are identical in the case where they yield the same result at every stage. No, they are identical if it is of their essence to yield the same result, i.e. if they are identical.

Page 221

180 If an amorphous theory of infinite aggregates is possible, it can describe and represent only what is amorphous about these aggregates.

Page 221

It would then really have to construe the laws as merely inessential devices for representing an aggregate. And abstract from this inessential feature and attend only to what is essential. But to what?

Page 221

Is it possible within the law to abstract from the law and see the extension presented as what is essential?

Page 221

This much at least is clear: that there isn't a dualism: the law and the infinite series obeying it; that is to say, there isn't something in logic like description and reality.

Page 221

Suppose I cut at a place where there is no rational number. Then there *must* surely be approximations to this cut. But what does 'closer to' mean here? *Closer* to what? For the time being I have nothing in the domain of number which I can approach. But I do in the case of a geometrical stretch. Here it is clear I can come arbitrarily close to any non-rational cut. And it is also clear that this is a process without an end and I am shown unambiguously how to go on by the spatial fact.

Page Break 222

Page 222

Once more it is only infinite possibility, but now the law is given in a different way.

Page 222

But can I be in doubt whether all the points of a line can actually be represented by arithmetical rules [†1]. Can I then ever find a point for which I can show that this is not the case? If it is given by means of a construction, then I can translate this into an arithmetical rule, and if it is given by chance, then there is, no matter how far I continue the approximation, an arithmetically defined decimal expansion which is concomitant with it.

Page 222

It is clear that a point corresponds to a rule.

Page 222

What is the situation with regard to types [†2] of rules, and does it make sense to talk of all rules, and so, of all points?

Page 222

In some sense or other there can't be irrational numbers of different types.

My feeling here is the following: no matter how the rule is formulated, in every case I still arrive at nothing else but an endless series of rational numbers. We may also put it like this: no matter how the rule is formulated, when I translate it into geometrical notation, everything is of the same type.

In the case of approximation by repeated bisection, we approach *every* point via *rational* numbers. There is no point which we could only approach with irrational numbers of a specific type.

It is of course possible that in determining a maximum I may stumble upon a new rule, but this has nothing essential to do with determining the maximum; it doesn't refer explicitly to a totality of real numbers.

XVII

181 The question would be: what criterion is there for the irrational numbers being *complete*?

Let us look at an irrational number: it runs through a series of rational approximations. When does it leave this series behind? Never. But then, the series also never comes to an end.

Suppose we had the totality of all irrational numbers with one single exception. How would we feel the lack of this one? And--if it were to be added--how would it fill the gap?--Suppose that it's π . If an irrational number is given through the totality of its approximations, then up to *any* point taken at random there is a series coinciding with that of π . Admittedly, for each such series there is a point where they diverge. But this point can lie arbitrarily far 'out'. So that for any series agreeing with π , I can find one agreeing with it still further. And so if I have the totality of all irrational numbers except π , and now insert π , I cannot cite a point at which π is now really needed. At *every* point it has a companion agreeing with it from the beginning on.

This shows clearly that an irrational number isn't the extension of an infinite decimal fraction, that it's a law.

Somehow it seems to follow from this--and this is something I find very compelling--that infinitely long isn't a measure of distance.

Our answer to the question above must be 'If π were an extension, we would never feel the lack of it', i.e. it would be impossible for us to observe a gap. If someone were to ask us, 'But have you then an infinite decimal expansion with m in the r -th place and n in the s -th place, etc.?', we could always oblige him.

Now let's assume we have been given all the irrational numbers that can be represented by laws, but that there are yet other irrationals, and I am given a cut representing a number not belonging to the first class: How am I to tell that this is so? This is impossible, since no matter how far I go with my approximations, there will always also be a corresponding fraction.

And so we cannot say that the decimal fractions developed in accordance with a law still need supplementing by an infinite set of irregular infinite decimal fractions that would be 'brushed under the carpet' if we were to *restrict* ourselves to those *generated by a law*. Where is there such an infinite decimal that is generated by no law? And how would we notice that it was missing? Where is the gap it is needed to fill?

If from the very outset only laws reach to infinity, the question whether the totality of laws exhausts the totality of infinite decimal fractions can make no sense at all.

The usual conception is something like this: it is true that the real numbers have a different multiplicity from the rationals, but you can still write the two series down alongside one another to begin with, and sooner or later the series of real numbers leaves the other behind and goes infinitely further on.

But my conception is: you can only put finite series alongside one another and in that way compare them;

there's no point in putting dots after these finite stretches (as signs that the series goes on to infinity). Furthermore, you can compare a law with a law, but not a law with *no* law.

Page 224

182 $\overset{5 \rightarrow 3}{\sqrt{2}}$ [$\dagger 1$]: I'm tempted to say, the individual digits are always only the results, the bark of the fully grown tree. What

Page Break 225

counts, or what something new can still grow from, is the inside of the trunk, where the tree's vital energy is. Altering the surface doesn't change the tree at all. To change it, you have to penetrate the trunk which is still living.

Page 225

Thus it's as though the digits were dead excretions of the living essence of the root. Just as when in the course of its vital processes a snail discharges chalk, so building on to its shell.

Page 225

There must first be the rules for the digits, and then--e.g.--a root is expressed in them. But this expression in a sequence of digits only has significance through being the expression for a real number. If someone subsequently alters it, he has only succeeded in distorting the expression, but not in obtaining a new number.

Page 225

The rules for the digits belong at the beginning, as a preparation for the expression.

Page 225

For the construction of the system in which the law lives out its life.

Page 225

183 And so I would say: If ' $\sqrt{2}$ ' is anything at all, then it is the same as $\sqrt{2}$, only another expression for it; the expression in another system.

Page 225

In that case we might also put this quite naively as follows: I understand what ' $\sqrt[4]{2}$ ' means, but not ' $\sqrt{2}$ ', since $\sqrt{2}$ has no places at all, and I can't substitute others for none.

Page 225

How about $1/7$ ($5 \rightarrow 3$)? Of course $0.\dot{1}4283\dot{7}$ isn't an infinite extension but once again an infinite rule, with which an extension

Page Break 226

can be formed. But it is such a rule as can so to speak digest the ($5 \rightarrow 3$).

Page 226

The suffix ($1 \rightarrow 5$) so to speak strikes at the heart of the law $0.1010010001\dots$. The law talks of a 1 and a 5 is to be substituted for this 1.

Page 226

Could we perhaps put it by saying ' $\sqrt{2}$ ' isn't a measure until it is in a system?

Page 226

It's as if a *man* were needed before the rule ' $\sqrt{2}$ ' could be carried out. Almost: if it's to be of any concern to arithmetic, the rule itself must understand *itself*. The rule ' $\sqrt{2}$ ' doesn't do this, it is made up out of two heterogeneous parts. The man applying it puts these parts together [$\dagger 1$].

Page 226

Does this mean that the rule ' $\sqrt{2}$ ' lacks something, viz. the connection between the system of the root and the system of the sequence of digits?

Page 226

You would no more say of ' $\sqrt{2}$ ' that it is a limit towards which the values of a series were tending, than you would of the instruction to throw dice.

Page 226

How far does $\sqrt[4]{2}$ have to be expanded for us to have some acquaintance with it? This of course means nothing. So we are already acquainted with it without its having been expanded at all. But in that case ' $\sqrt{2}$ ' doesn't mean a thing.

The idea behind $\sqrt{2}$ is this: we look for a rational number which, multiplied by itself, yields 2. There isn't one. But there are those which in this way come close to 2 and there are always some which approach 2 more closely still. There is a procedure permitting me to approach 2 indefinitely closely. This procedure is itself something. And I call it a real number.

It finds expression in the fact that it yields places of a decimal fraction lying ever further to the right.

Only what can be foreseen about a sequence of digits is essential to the real number.

184 That we can apply the law, holds also for the law to throw the digits like dice.

And what distinguishes π' from this can only be its arithmetical definiteness. But doesn't that consist in our knowing that there must be a law governing the occurrences of the digit 7 in π ; even if we don't yet know what this law is?

And so we could also say: π' alludes to a law which is as yet unknown (unlike $1/7$).

But mightn't we now say: π contains the description of a law 'the law in accordance with which 7 occurs in the expansion of π '? Or would this allusion only make sense if we knew how to derive this law? (Solution of a mathematical problem.)

In that case I confessedly cannot simply read this law off from the prescription, and so the law in it is contained in a language I can't read. And so in this sense too I don't understand π' .

But then how about the solubility of the problem of finding this law? Isn't it only a problem in so far as we *know* the method for solving it?

And if it is known, precisely *that* gives π' its sense, and if

unknown, we can't speak about the law which we don't yet know, and π' is bereft of all sense. For if no law presents itself, π' becomes analogous to the instruction to follow the throws of dice.

185 A real number lives in the substratum of the operations out of which it is born.

We could also say: " $\sqrt{2}$ " means the method whereby x^2 approximates to 2.

Only a path approaches a goal, positions do not. And only a law approaches a value.

x^2 approaching 2, we call x approaching $\sqrt{2}$.

186 The letter π stands for a law. The sign π' (or: $\overset{7 \rightarrow 3}{\pi}$) means nothing, if there isn't any talk of a 7 in the law for π , which we could then replace by a 3. Similarly for $\overset{3 \rightarrow 5}{\sqrt{2}}$. (Whereas $\overset{2 \rightarrow 5}{\sqrt{2}}$ might mean $\sqrt{5}$).

A real number *yields* extensions, it is not an extension.

A real number is: an arithmetical law which endlessly yields the places of a decimal fraction.

This law has its position in arithmetical space. Or you might also say: in algebraic space.

Whereas π' doesn't use the idioms of arithmetic and so doesn't assign the law a place in this space.

Page 228

It's as though what is lacking is the arithmetical creature which produces these excretions.

Page 228

The impossibility of comparing the sizes of π and π' ties in with this homelessness of π' .

Page 228

You cannot say: two real numbers are identical, if all their places coincide. You cannot say: they are different, if they disagree in one

Page Break 229

of the places of their expansion. No more can you say the one is greater than the other if the first place at which they disagree is greater for the first than the second.

Page 229

Suppose someone were to invent a new arithmetical operation, which was normal multiplication, but modified so that every 7 in the product was replaced by a 3. Then the operation \times' would have something about it we didn't understand so long as we lacked a law through which we could understand the occurrence of 7 in the product in general.

Page 229

We would then have here the extraordinary fact that my symbolism would express something I don't understand. (But that is absurd.)

Page 229

It is clear that were I able to apply \times' all doubts about its legitimacy would be dispelled. For the possibility of application is the real criterion for arithmetical reality.

Page 229

Even if I wasn't already familiar with the rule for forming $\sqrt{2}$, and I took $\overset{7 \rightarrow 3}{\sqrt{2}}$ to be the original prescription, I would still ask: what's the idea of this peculiar ceremony of replacing 7 by 3? Is it perhaps that 7 is tabu, so that we are forbidden to write it down? For substituting 3 for 7 surely adds absolutely nothing to the law, and in this system it isn't an arithmetical operation at all.

Page 229

Put geometrically: it's not enough that someone should--supposedly--determine a point ever more closely by narrowing down its whereabouts; we must be able to construct *it*.

Page 229

To be sure, continual throwing of a die indefinitely restricts the possible whereabouts of a point, but it doesn't determine a point.

Page 229

After *every* throw the point is still infinitely indeterminate.

Page 229

Admittedly, even in the course of extracting a root in the usual way, we constantly have to apply the rules of multiplication

Page Break 230

appropriate at that point, and their application has also not been anticipated. But neither is there any mention of them and their application in the principle of $\sqrt{2}$.

Page 230

A number must measure. And this doesn't mean merely: values in its expansion must measure. For we can't talk of *all* values, and that rational numbers (which I have formed in accordance with some rule) measure goes without saying.

Page 230

What I mean might be put like this: for a real number, a construction and not merely a process of approximation must be conceivable.--The construction corresponds to the unity of the law.

Page 230

187 $\overset{10:3}{10} = 0.\overset{3}{3}$. That we come full circle is what I actually see and express by means of $\overset{3}{3}.\overset{3}{3}$ doesn't mean 'nothing but 3s come', but 'a 3 must recur again and again'.

Page 230

Understanding the rule and how to carry it out in practice always only helps us over finite stretches. To determine a real number it must be completely intelligible *in itself*. That is to say, it must not be essentially undecided whether a part of it could be dispensed with.

For in that case it simply isn't clearly given, for there is no extension which would be equivalent to it, and in itself it is indeterminate. π' in that case sets out to seek its fortune in infinite space.

Of course, if a and b do not agree for the first time at the fourth place, we can say that therefore they are unequal. This fourth place clearly does belong to both numbers; but not the indefinite n th place in the infinite progression.

Thus we can certainly tell that π and e are different from the difference in their *first* place. But we can't say that they would be equal, if all their places were equal.

If the extensions of two laws coincide as far as we've gone, and I cannot compare the laws as such, the numbers defined, if I have any right to talk of such numbers, cannot be compared, and the question which is greater or whether they are equal is nonsense. Indeed, an equation between them must be nonsense. And that gives one pause for thought. And it's true: we cannot mean anything by equating them, if there is no inner connection between them; if they belong to different systems. (And the extension is of no use to us.)

But then, are what can't be compared with one another really *numbers*?

Doesn't that contradict the simple image of the number line?

188 There is no number outside a system.

The expansion of π is simultaneously an expression of the nature of π and of the nature of the decimal system.

Arithmetical operations only use the decimal system as a means to an end; that is, the rules for the operations are of such a kind that they can be translated into the language of any other number system, and do not have any of them as their *subject matter*.

The expansion of π is admittedly an expression both of the nature of π and of the decimal notation, but our interest is usually restricted exclusively to what is essential to π , and we don't bother about the latter. That is a servant which we regard merely as a tool and not as an individual in its own right. But if we now regard it as a member of society, then that alters society.

A general rule of operation gets its generality from the generality of the alteration it effects in the numbers.

That is why $\overset{7 \rightarrow 3}{\times}$ won't do as a general rule of operation, since the result of $a \overset{7 \rightarrow 3}{\times} b$ doesn't

depend solely on the nature of the numbers a and b ; the decimal system also comes in. Now, that wouldn't matter, of course, if this system underlay the operation as a further constant $(\sum \frac{1}{100^n})$, and we can certainly find an operation that corresponds to \times : which then has not only a and b but also the decimal system as its *subject-matter*. This operation will be written in a number system which withdraws itself as a servant into the background, and of which there is no mention in the operation.

In just this way $\overset{7 \rightarrow 3}{\pi}$ makes the decimal system into its subject matter (or would have to do so, if it were genuine), and for that reason it is no longer sufficient that we can use the rule to form the extension. For this application has now ceased to be the criterion for the rule's being in order, since it is not the expression of the arithmetical law at all, but only makes a superficial alteration to the language.

And so, if the decimal system is to stop being a servant, it must join the others at table, observing all the required forms, and leave off serving, since it can't do both at once.

This is how it is: the number π is expressed in the decimal system. You can't achieve a modification of this law by fixing on the specific expression in the decimal system. What you thereby influence isn't the law, it's its accidental expression. The influence does not penetrate as far as the law at all. Indeed it stands separated from it on the other side. It's like trying to influence a creature by working on a secretion that has already been discharged.

Page 232

$$\sum_{p=1}^{p=p} \frac{1}{10^p}$$

189 What about a law $p=1$, (where p runs through the series of primes)? Or where p runs through the series of whole numbers except for those for which the equation of Fermat's Last Theorem doesn't hold.--Do these laws define real numbers?

Page 232

I say: the so-called 'Fermat's Last Theorem' isn't a proposition [\dagger 1]. (Not even in the sense of a proposition of arithmetic.) Rather, it

Page Break 233

corresponds to a proof by induction. Now, if there is a number $F = 0.110000$ etc., and that proof succeeds, that would surely prove that $F = 0.11$ --and isn't that a proposition?! Or: it is a proposition, if the law F is a number.

Page 233

A proof proves what it proves and no more.

Page 233

$$\sum_{n=1}^{n=n} \frac{1}{10^n}$$

The number F wants to use the spiral $n=1$ and choose sections of this spiral according to a principle. But this principle doesn't belong to the spiral.

Page 233

If I imagine the windings of the spiral

$$1/10^0, 1/10^0 + 1/10^1, 1/10^0 + 1/10^1 + 1/10^2, \text{ etc.}$$

to have been written out, then the number F makes a comment on each winding, it puts a tick or a cross against each one; and, what's more, making its choices *according to a law we don't know*.

Page 233

And this is how we arrive at the paradox that it's nonsense to ask whether $F = 0.11$. For, accepting F depends upon accepting the assumption of a law, an infinite law, which governs the behaviour of the numbers in the Fermat formula.--But what indicates to us the infinity of the law? Only the induction. And where is that to be found here? In the infinite possibility of the exponent n in $x^n + y^n = z^n$, and so in the infinite possibility of making tests. But that doesn't have any different value for us from that of the infinite possibility of throwing dice, since we don't know a law to which the *results* of such tests would conform.

Page 233

There is admittedly a law there (and so also an arithmetical interest), but it doesn't refer directly to the number. The number is a sort of lawless by-product of the law. As though someone went along the street at a regulation pace, throwing a die at every pace, and constantly either putting a peg in the ground or not, as directed by the fall of the die; in this case these pegs wouldn't be spaced out in accordance with a law.

Page Break 234

Page 234

Or rather, the law spacing them would only be that governing the strides and no other.

Page 234

Does it then make no sense to say, even after Fermat's Last Theorem has been proved, that $F = 0.110$? (If, say, I were to read about it in the papers.)

Page 234

The true nature of real numbers must be the induction. What I must look at in the real number, its sign, is the induction.--The 'So' of which we may say 'and so on'. If the law, the winding of the spiral, is a number, then it must be comparable with all the others through its position (on the number scale).

Page 234

I certainly do not define that position by means of anything but the law.

Only what I see, is a law; not what I *describe*.

I believe that is the only thing standing in the way of my expressing more by my signs than I can understand.

XVIII

190 In this context we keep coming up against something that could be called an 'arithmetical experiment'. Admittedly the data determine the result, but I can't see *in what way* they determine it. (cf. e.g. the occurrences of 7 in π .) The primes likewise come out from the method for looking for them, as the results of an experiment. To be sure, I can convince myself that 7 is a prime, but I can't see the connection between it and the condition it satisfies.--I have only found the number, not generated it.

I look for it, but I don't generate it. I can certainly see a law in the rule which tells me how to find the primes, but not in the numbers that result. And so it is unlike the case $+ 1/1!$, $- 1/3!$, $+ 1/5!$, etc., where I can see a law *in the numbers*.

I must be able to write down a part of the series, in such a way that you can *recognize* the law.

That is to say, no *description* is to occur in what is written down, everything must be represented.

The approximations must themselves form what is *manifestly* a series.

That is, the approximations themselves must obey a law.

Can we say that unless I knew the geometrical representation of π and $\sqrt{2}$, I would only have an approximate knowledge of these numbers? Surely not.

191 A number must measure in and of itself.

It seems to me as though that's its job.

If it doesn't do that but leaves it to the rationals, we have no need of it.

It seems to be a good rule that what I will call a number is that which can be compared with any rational number taken at random. That is to say, that for which it can be established whether it is greater than, less than, or equal to a rational number.

That is to say, it makes sense to call a structure a number by analogy, if it is related to the rationals in ways which are analogous to (of the same multiplicity as) greater, less and equal to.

A real number is what can be compared with the rationals.

When I say I call irrational numbers only what can be compared with the rationals, I am not seeking to place too much weight on the mere stipulation of a name. I want to say that this is precisely what has been meant or looked for under the name 'irrational number'.

Indeed, the way the irrationals are introduced in text books always makes it sound as if what is being said is: Look, that isn't a rational number, but still there is a number there. But why then do we still call what *is* there 'a number'? And the answer must be: because there is a definite way for comparing it with the rational numbers.

'The process would only define a number when it has come to an end, but since it goes on to infinity and is never complete, it *doesn't* define a number.'

The process must have infinite foresight, or else it won't define a number. There must be no 'I don't as yet know', since there's no 'as yet' in the infinite.

Page 236

Every rational number must stand in a visible relation to the law which is a number.

Page 236

The true expansion is just the method of comparison with the rationals.

Page Break 237

Page 237

The true expansion of a number is the one which permits a direct comparison with the rationals.

Page 237

If we bring a rational number into the neighbourhood of the law, the law must give a definite reaction to it.

Page 237

It must reply to the question 'Is it *this* one?'

Page 237

I should like to say: The true expansion is that which evokes from the law a comparison with a rational number.

Page 237

Narrowing down the interval of course contributes to the comparison through the fact that every number thereby comes to lie to the left or right of it.

Page 237

This only holds when comparing the law with a given rational number forces the law to declare itself in comparison with this number.

Page 237

192 A real number can be compared with the fiction of an infinite spiral, whereas structures like F , $P[\dagger 1]$, or π only with finite sections of a spiral.

Page 237

For my inability to establish on which side it passes by a point, simply means that it is absurd to compare it with a complete (whole) spiral, for with that I would see how it goes past the point.

Page 237

You see, at the back of our minds here, we always have the idea that while I don't know the spiral as a whole, and so don't know what its path is at this point, what I don't know is still in fact thus or so.

Page 237

193 If I say $(\sqrt[n]{2})^2$ approaches 2 and so eventually reaches the numbers 1.9, 1.99, 1.999, that is nonsense unless I can state within how many stages these values will be reached, for 'eventually' means nothing.

Page 237

To compare rational numbers with $\sqrt{2}$, I have to square them.--They then assume the form \sqrt{a} , where \sqrt{a} is now an arithmetical operation.

Page 237

Written out in this system, they can be compared with $\sqrt{2}$, and it is for me as if the spiral of the irrational number had shrunk to a point.

Page Break 238

Page 238

We don't understand why there is a 4 at the third decimal place of $\sqrt{2}$, but then we don't *need* to understand it.--For this lack of understanding is swallowed up in the wider (consistent) use of the decimal system.

Page 238

In fact, in the end the decimal system as a whole withdraws into the background, and then only what is essential to $\sqrt{2}$ remains in the calculation.

Page 238

194 Is an arithmetical experiment still possible when a recursive definition has been set up? I believe, obviously not; because via the recursion each stage becomes arithmetically comprehensible.

Page 238

And in recursion we do not start from another generality, but from a particular arithmetical case.

A recursive definition conveys understanding by building on one particular case that presupposes no generality.

To be sure, I can give a recursive explanation of the rule for investigating numbers in the cases $([†1], F, \text{ and } P)$, but not of the outcome of such investigation. I cannot construct the result.

Let $\rightarrow 4$ mean: 'The fourth prime number'. Can $\rightarrow 4$ be construed as an arithmetical operation applied to the basis 4? So that $\rightarrow 4 = 5$ is an equation of arithmetic, like $4^2 = 16$?

Or is it that $\rightarrow 4$ can 'only be sought, but not constructed'?

195 Is it possible to prove a greater than b , without being able to prove at which place the difference will come to light? I think not.

How many noughts can occur in succession in e ? If the n th decimal place is followed by a 0, and if it is fixed after $n + r$ stages of the summation $[†1]$ then the 0 must be fixed at the same time as the n th place, for another number can only give way to an 0, if the place preceding it also still changes. Thus the number of noughts is limited.

We can and must show the decimal places to be fixed after a *definite* number of stages.

If I don't know how many 9s may follow after 3.1415, it follows that I can't specify an interval smaller than the difference between π and 3.1416; and that implies, in my opinion, that π doesn't correspond to a point on the number line, since, if it does correspond to a point, it must be possible to cite an interval which is smaller than the interval from this point to 3.1416.

If the rational number with which I want to compare my real number is given in decimal notation, then if I am to carry out the comparison I must be given a relation between the law of the real number and the decimal notation.

1.4--Is that the square root of 2? No, it's the root of 1.96. That is, I can immediately write it in the form of an approximation to $\sqrt{2}$; and of course, see whether it is an approximation above or below $[†2]$.

What is an approximation? (Surely all rational numbers lie either above or below the irrational number.) An approximation is a rational number written in such a form that it can be compared with the irrational number.

In that case, decimal expansion is a method of comparison with

the rationals, if it is determined in advance how many places I must expand to in order to settle the issue.

196 A number as the result of an arithmetical experiment, and so the experiment as the *description* of a number, is an absurdity.

The experiment would be the description, not the *representation* of a number.

I *cannot* compare F with $11/100$, and so it isn't a number.

If the real number is a rational number a , comparison of its law with a must show this. That means the law must be so formed as to 'click into' the rational number when it comes to the appropriate place (this number).

It wouldn't do, e.g., if we couldn't be sure whether $\sqrt{25}$ really breaks off at 5.

We might also put it like this: the law must be such that any rational number can be inserted and tried out.

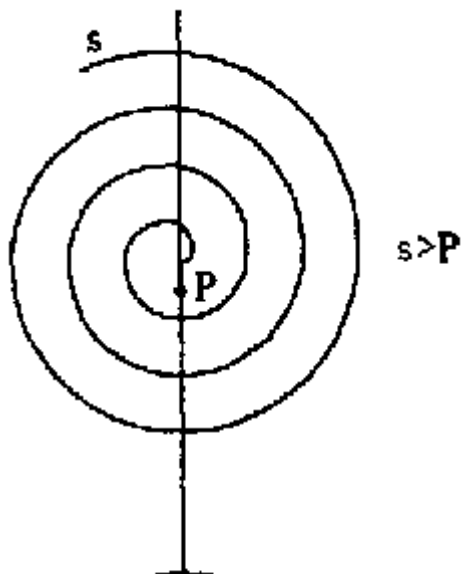

Page 240

But in that case what about a number like $P = 0.11101010001$ etc.? Suppose someone claimed it was a recurring decimal, and also at some stage or other it looked as if it were, then I would have to be able to try out the supposed number in the law, just as I can see directly by multiplication whether 1.414 is $\sqrt{2}$. But that isn't possible.

Page 240

The mark of an arithmetical experiment is that there is something opaque about it.

Page Break 241

Page 241

197 A *subsequent* proof of convergence cannot justify construing a series as a number.

Page 241

Where a convergence *reveals* itself, that is where the number must be sought.

Page 241

A proof showing something has the properties necessary to a number, must *indicate* the number. That is, the proof is simply what points the number out.

Page 241

Isn't F also an unlimited contraction of an interval? [\dagger 1]



Page 241

How can I know that or whether the spiral will not focus on this point? In the case of $\sqrt{2}$ I do know.

Page 241

Now, can I also call such a spiral a number? A spiral which can, for all I know, come to a stop at a rational point.

Page 241

But that isn't possible either: there is a lack of a *method* for comparing with the rationals.

Page 241

For developing the extension isn't such a method, since I can never know if or when it will lead to a decision.

Expanding indefinitely isn't a method, even when it leads to a

result of the comparison.

Whereas squaring a and seeing whether the result is greater or less than 2 is a method.

Could we say: what is a real number is the *general method* of comparison with the rationals?

It must make sense to ask: 'Can this number be π '?

198 F is not the interval $0-0.1$; for I can also make a certain decision within this interval, but it isn't a number inside this interval, since we can't force the issues that would be necessary for that.

Might we then say: F is certainly an arithmetical structure, only not a number (nor an interval)?

That is, I can compare F neither with a point nor with an interval. Is there a geometrical structure to which that corresponds?

The law, i.e. the method of comparison, only says that it will yield either the answers 'greater, less or equal'--or--'greater' (but not equal). As though I go into a dark room and say: I can only find out whether it is lower than I am or the same height--or--higher. And here we might say: and so you can't find out a height; and so what is it you can find out? The comparison only goes lame because I can surely establish the height if I bump my head, whereas, in the case of F , I cannot, in principle, ask: 'Is it this point?'

I don't know a method for determining whether it is this point, and so it isn't a point.

If the question how F compares with a rational number has no sense, since all expansion still hasn't given us an answer, then this question also had no sense before we tried to settle the question at random by means of an extension.

If it makes no sense now to ask 'Does $F = 0.11$ '?', then it had no

sense even before people examined 100 places of the extension, and so even before they had examined only one.

But then it would make no sense at all to ask in this case whether the number is equal to *any* rational number whatsoever. As long, that is, as we don't possess a method which necessarily settles the question.

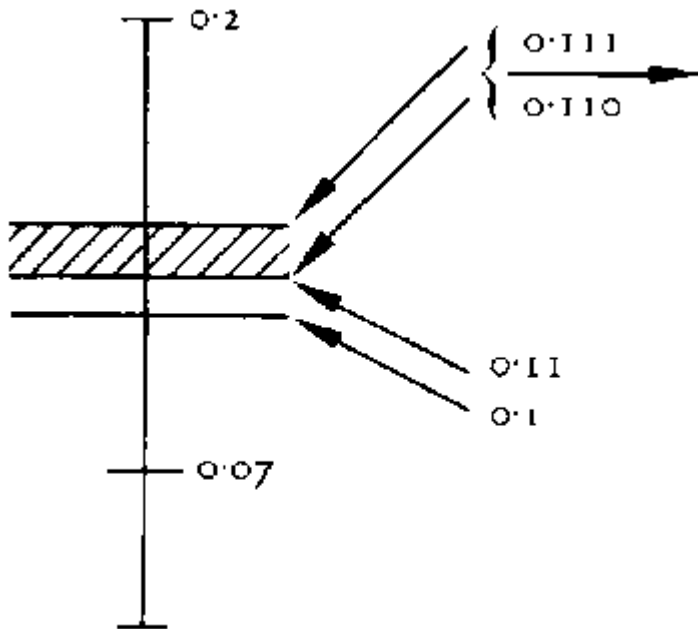

Page 243

This is as much as I know to date about the 'number'.

Page 243

The rational number given is either equal to, less than or greater than the interval that has so far been worked out. In the first case the point forms the lower end point of the interval, in the second it lies below, in the third, above the interval. In none of these cases are we talking about comparing the positions of two points.

Page 243

199 $0.\dot{3}$ is not a result of $1/3$ in the same sense as, say, 0.25 is of $1/4$; it points to a different arithmetical fact.

Page 243

Suppose the division continually yielded the same digit, 3, but without our seeing in it the necessity for this, would it then make sense to form the conjecture that the result will be $0.\dot{3}$?

Page 243

That is, doesn't $0.\dot{3}$ simply designate an induction we have seen and not--an extension?

Page 243

We must always be able to determine the order of magnitude. Suppose (in my notation) nothing speaks against 100 threes following in succession in e at a particular point, then something

Page Break 244

speaks against 10^{100} threes doing so. (A great deal must be left open in the decimal system, that is definite in the binary system.)

Page 244

It isn't only necessary to be able to say whether a given rational number is the real number: we must also be able to say how close it can possibly come to it. That is, it isn't enough to be able to say that the spiral doesn't go through this point but beneath it: we must also know limits within which the distance from the point lies. We must know an order of magnitude for the distance apart.

Page 244

Decimal expansion doesn't give me this, since I cannot know, e.g. how many 9s will follow a place that has been reached in the expansion.

Page 244

The question 'Is e $2.7\dot{3}$?' is meaningless, since it doesn't ask about an extension, but about a law, i.e. an induction of which we have, however, no conception here. We can put this question in the case of division only because we know the form of the induction we call $\dot{3}$.

Page 244

The question 'Are the decimal places of e eventually fixed?' and the answer 'They are eventually fixed', are both nonsense. The question runs: After how many stages do the places have to remain fixed?

Page 244

May we say: 'e isn't this number' means nothing--we have to say 'It is at least this interval away from it'?

Page 244

I believe that's how it is. But that implies it couldn't be answered at all unless we were simultaneously given a concept of the distance apart.

Page Break 245

Page 245

From F. Waismann's shorthand notes of a conversation on 30 December 1930

A proof for all real numbers is not analogous to a proof for all rational numbers in such a way that you could say: What we have proved for all rational numbers--i.e. by induction--we can prove for all real numbers in *the same way* by an extension of the method of proof. You can only speak about a real number when you've got it.

Page 245

Let us assume e.g., I have proved the formula $a^m \cdot a^n = a^{m+n}$ for rational values of m and n (by induction), and would now like to prove it for real number values. What do I do in this case? Obviously it's no longer possible to carry through the proof by induction.

Page 245

Therefore such a formula doesn't mean: for all real numbers such and such holds, but: given a real number, I interpret the formula so as to mean: such and such holds for the limit and I prove this by the rules of calculation laid down for the real numbers. I prove the formula for rational numbers by induction, and then show it carries over to the real numbers, in fact simply by means of the rules of calculation I have laid down for the real numbers. But I don't prove the formula holds for 'all real' numbers, precisely because the rules of calculation for real numbers do not have the form of an induction.

Page 245

This, then, is how things are: I treat as given a *particular* real number and keep this constant throughout the proof. That's something totally different from what happens with the rationals; for there it was precisely a question of whether the formula remained correct when the rational numbers were varied, and *that is why* the proof had the form of an induction. But here the question simply doesn't arise whether the formula holds for 'all real' numbers--just because we don't allow the real number to vary at all.

Page 245

We don't let the variable real number run through all values--

Page Break 246

i.e. all laws. We simply rely on the rules of calculation and nothing else.

Page 246

You might now think: strictly the proposition ought to be proved for all real numbers, and what we give is no more than a pointer. That's wrong. A formula that is proved for real numbers doesn't say: For all real numbers... holds; what it says is: Given a real number, then... holds. And in fact not on the basis of a proof, but of an interpretation.

Page Break 247

Page 247

200 Our interest in negation in arithmetic appears to be limited in a peculiar way. In fact it appears to me as if a certain generality is needed to make the negation interesting.

Page 247

But you can represent *indivisibility perspicuously* (e.g. in Eratosthenes' sieve). You can *see* how all the composite numbers lie above or below the number under consideration.

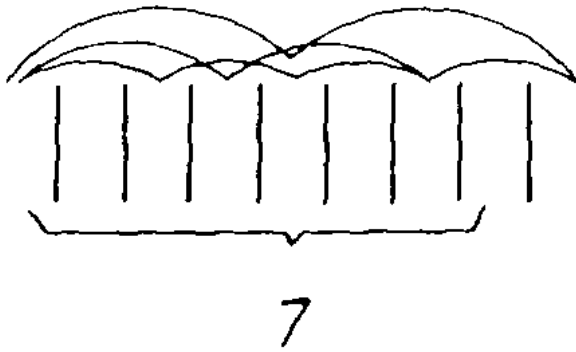

Page 247

Here, arithmetical negation is represented by spatial negation, the 'somewhere else'.

Page 247

What do I *know*, if I know a mathematical inequality? Is it possible to know just an inequality, without knowing something *positive*?

Page 247

It seems clear that negation means something different in arithmetic from what it means in the rest of language. If I say 7 is not divisible by 3, then I can't even make a picture of this, I can't imagine how it would be if 7 were divisible by 3. All this follows naturally from the fact that mathematical equations aren't a kind of proposition.

Page 247

It is very odd that for a presentation of mathematics we should be obliged to use false equations as well. For that is what all this is about. If negation or disjunction is necessary in arithmetic, then false equations are an essential element in its presentation.

Page Break 248

Page 248

What does ' $\sim(5 \times 5 = 30)$ ' mean? It seems to me as if you oughtn't to write it *like that*, but ' $5 \times 5 \neq 30$ '; the reason being that I am not negating anything, but want to establish a relation, even if an indefinite one, between 5×5 and 30 (and so, something positive).--Admittedly you could say: 'True, but this relation is at any rate incompatible with $5 \times 5 = 30$ '.--And so is the relation of indivisibility with the relation of divisibility! It's quite clear that when I exclude divisibility, in this logical system this is equivalent to establishing indivisibility.--And isn't this the same case as that of a number which is less than 5, if it is *not* greater than or equal to it?

Page 248

201 Now, there is something recalcitrant to the application of the law of the excluded middle in mathematics.

Page 248

(Of course even the name of this law is misleading: it always sounds as though this were the same sort of case as 'A frog is either green or brown, there isn't a third type'.)

Page 248

You can show by induction that when you successively subtract 3 from a number until it won't go any further, the remainder can only be either 0 or 1 or 2. You call the cases of the first class those in which the division goes out.

Page 248

Looking for a law for the distribution of primes is simply an attempt to replace the negative criterion for a prime number by a positive one. Or more correctly, the indefinite one by a definite one.

Page 248

I believe that negation here is not what it is in logic but an indefiniteness. For how do I recognize--verify--a negative? By something indefinite or positive.

Page 248

An inequality, like an equation, must be either the result of a calculation or a stipulation.

Page Break 249

Page 249

Just as equations can be construed, not as propositions, but as rules for signs, so it must be possible to treat inequalities in the same way.

Page 249

How, then, can you use an inequality? That leads to the thought that in logic there is also the internal relation of not following, and it can be important to recognize that one proposition does *not* follow from another.

Page 249

The denial of an equation is as like and as unlike the denial of a proposition as the affirmation of an equation is like and unlike the affirmation of a proposition.

Page 249

202 It is quite clear that negation in arithmetic is completely different from the genuine negation of a proposition.

Page 249

And it is of course clear that where it essentially--on logical grounds--corresponds to a disjunction or to the exclusion of one part of a logical series in favour of another, it must have a completely different meaning.

Page 249

It must in fact be one and the same as those logical forms and therefore be only apparently a negation.

Page 249

If 'not equal to' means greater or less than, then that cannot be, as it were, an accident which befalls the 'not'.

Page 249

A mathematical *proposition* can only be either a stipulation, or a result worked out from stipulations in accordance with a definite method. And this must hold for '9 is divisible by 3' or '9 is not divisible by 3'.

Page 249

How do you work out $2 \times 2 \neq 5$? Differently from $2 \times 2 = 4$? If at all, then by $2 \times 2 = 4$ and $4 \neq 5$.

Page 249

And how do you work out '9 is divisible by 3'? You could treat it as a disjunction and first work out $9 \div 3 = 3$, and then, instead of this definite proposition, use a rule of inference to derive the disjunction.

Page Break 250

Page 250

Aren't we helped here by the remark that negation in arithmetic is important only in the context of generality? But the generality is expressed by an induction.

Page 250

And that is what makes it possible for negation or disjunction, which appear as superfluously indefinite in the particular case, yet to be essential to arithmetic in the general 'proposition', i.e. in the induction.

Page 250

203 It is clear to me that arithmetic doesn't need false equations for its construction, but it seems to me that you may well say 'There is a prime number between 11 and 17', without *ipso facto* referring to false equations.

Page 250

Isn't an inequality a perfectly intelligible rule for signs, just as an equation is? The one permits a substitution, the other forbids a substitution.

$$\sqrt{\quad} = 2\sqrt{\quad}, \quad \sqrt{\quad} \neq 3\sqrt{\quad}$$

Page 250

Perhaps all that's essential is that you should see that what is expressed by inequalities is *essentially* different from what is expressed by equations. And so you certainly can't immediately compare a law yielding places of a decimal expansion which works with inequalities, with one that works with equations. Here we have before us completely different methods and consequently different kinds of arithmetical structure.

Page 250

In other words, in arithmetic you cannot just put equations and something else (such as inequalities) on *one* level, as though they were different species of animals. On the contrary, the two methods will be categorically different, and determine (define) structures not comparable with one another.

Page 250

Negation in arithmetic cannot be the same as the negation of a proposition, since otherwise, in $2 \times 2 \neq 5$, I should have to make myself a picture of how it would be for 2×2 to be 5.

Page Break 251

Page 251

204 You could call '= 5', 'divisible by 5', 'not divisible by 5', 'prime', arithmetical predicates and say: arithmetical predicates always correspond to the application of a definite, generally defined, method. You might also define a

predicate in this way: $(\xi \times 3 = 25) \stackrel{\text{Def}}{=} F(\xi)$.

Arithmetical predicates, which in the particular case are unimportant because the definite form makes the indefinite superfluous--become significant in the general *law*, i.e. in induction. Since here they are not--so to speak--superseded by a definite form. Or better: In the general law, they are in no way indefinite.

Could the results of an engineer's computations be such that, let us say, it is essential for certain machine parts to have lengths corresponding to the prime number series? No.

Can you use the prime numbers to construct an irrational number? The answer is always: as far as you can foresee the primes and no further.

If you can foresee that a prime number must occur in *this* interval then this interval is what can be foreseen and constructed, and so, I believe, it can play a role in the construction of an irrational number.

XX

205 Can we say a patch is simpler than a larger one?

Let's suppose they are uniformly coloured circles: what is supposed to constitute the greater simplicity of the smaller circle?



Someone might reply that the larger one can be made up out of the smaller one and a further part, but not vice versa. But why shouldn't I represent the smaller one as the difference between the larger one and the ring?

And so it seems to me that the smaller patch is not simpler than the larger one.

It seems as if it is impossible to see a uniformly coloured patch as composite, unless you imagine it as *not* uniformly coloured. The image of a dissecting line gives the patch more than one colour, since the dissecting line must have a different colour from the rest of the patch.



May we say: If we see a figure in our visual field--a red triangle say--we cannot then describe it by e.g. describing one half of the triangle in one proposition, and the other half in another. That is, we may say that there is a sense in which there is no such thing as a half of *this* triangle. We can only speak of the triangle at all if its boundary lines are the boundaries between two colours.

This is how it is with the composition of spatial structures out of their smaller spatial components: the larger *geometrical* structure isn't composed of smaller *geometrical* structures, any more than you can say that 5 is composed of 3 and 2, or for that matter 2 of 5 and--3. For here the larger determines the smaller quite as much as the

smaller the larger. The rectangle  isn't composed of the rectangles  ; instead the first geometrical figure determines the other two and conversely. Here, then, Nicod would be right

when he says [†1] that the larger figure doesn't contain the smaller ones as components. But it is different in actual



space: the figure  is actually composed of the components , even though the purely geometrical figure of the large rectangle is *not* composed of the figures of the two squares.

These 'purely geometrical figures' are of course only logical possibilities.--Now, you can in fact see an actual chess board as a unity not as composed of its squares--by seeing it as a large rectangle and disregarding its squares.--But if you don't disregard the squares, then it is a complex and the squares are its component parts--they are, in Nicod's phrase, what constitute it.

(Incidentally, I am unable to understand what is supposed to be meant by saying that something is 'determined' by certain objects but not 'constituted' by them. If these two expressions make sense at all, it's the same sense.)

Page 253

An intellect which takes in the component parts and their relations, but not the whole, is a nonsense notion.

Page 253

206 Whether it makes sense to say 'This part of a red patch (which isn't demarcated by any visible boundary) is red' depends on whether there is absolute position. For if we can speak of an absolute location in visual space, I can then also ascribe a colour to this absolute location even if its surroundings are the same colour.

Page 253

I see, say, a uniformly yellow visual field and say: 'The centre of my visual field is yellow.' But then can I describe a *shape* in this way?

Page 253

An apparent remedy would appear to be to say that red and circular are (external) properties of two objects, which one might call patches and that in addition these patches are spatially related to each other in a certain way; but this is nonsense.

Page 253

It's obviously possible to establish the identity of a position in the visual field, since we would otherwise be unable to distinguish

Page Break 254

whether a patch always stays in the same place or whether it changes its place. Let's imagine a patch which vanishes and then reappears, we can surely say whether it reappears in the same place or at another.

Page 254

So we can really speak of certain positions in the visual field, and in fact with the same justification as in speaking of different positions on the retina.

Page 254

Would it be appropriate to compare such a space with a surface that has a different curvature at each of its points, so that each point is marked out as distinct?

Page 254

If every point in visual space is marked out as distinct, then there is certainly a sense in speaking of *here* and *there* in visual space, and that now seems to me to simplify the presentation of visual states of affairs. But is this property of having points marked out as distinct really essential to visual space; I mean, couldn't we imagine a visual space in which we would only perceive certain spatial relations but no absolute position? That is, could we picture an experience so? In something like the sense in which we can imagine the experiences of a one-eyed man?--I don't believe we could. For instance, one wouldn't be able to perceive the whole visual field turning, or rather this would be inconceivable. How would the hand of a clock look, say, when it moved around the edge of the dial? (I am imagining the sort of dial you find on many large clocks, that only has points on it, and not digits.) We would then indeed be able to perceive the movement from one point to another--if it didn't just jump from one position to the other--but once the hand had arrived at a point, we wouldn't be able to distinguish its position from the one it was in at the last point. I believe it speaks for itself that we can't visualise this.

Page 254

In visual space there is absolute position and hence also absolute motion. Think of the image of two stars in a pitch-black night, in which I can see nothing but these stars and they orbit around one another.

Page Break 255

Page 255

We can also say visual space is an oriented space, a space in which there is an above and below and a right and left.

Page 255

And *this* above and below, right and left have nothing to do with gravity or right and left hands. It would, e.g., still retain its sense even if we spent our whole lives gazing at the stars through a telescope.

Page 255

Suppose we are looking at the night sky through a telescope, then our visual field would be completely dark with a brighter circle and there would be points of light in this circle. Let us suppose further that we have never seen our bodies, always only this image, so that we couldn't compare the position of a star with that of our head or our

feet. What would then show me that my space has an above and below etc., or simply that it is oriented? I can at any rate perceive that the whole constellation *turns* in the bright circle and that implies I can perceive different orientations of the constellation. If I hold a book the wrong way, I can't read the print at all, or only with difficulty.

Page 255

It's no sort of *explanation* of this situation to say: it's just that the retina has an above and below etc., and this makes it easy to understand that there should exist the analogue in the visual field. Rather, that is just a *representation* of the situation by the roundabout route of the relations on the retina.

Page 255

We might also say, the situation in our visual field is always such as would arise if we could see, along with everything else, a coordinate frame of reference, in accordance with which we can establish any direction.--But even that isn't an accurate representation, since if we really saw such a set of axes of co-ordinates (say, with arrows), we would in fact be in a position, not only to establish the orientations of objects relative to these axes, but also the position of the cross itself in the space, as though in relation to an unseen coordinate system contained in the essence of this space.

Page 255

What would our visual field have to be like, if this were not so? Then of course I could see relative positions and motions, but not

Page Break 256

absolute ones. But that would mean, e.g., that there would be no sense in speaking of a rotation of the whole visual field. Thus far it is perhaps comprehensible. But now let's assume that, say, we saw with our telescope only one star at a certain distance from the black edge: that this star vanishes and reappears at the same distance from the edge. In that case we couldn't know whether it reappears at the same place or in another. Or if two stars were to come and go at the same distance from the edge, we couldn't say whether--or that--they were the same or different stars.

Page 256

Not only: 'we couldn't know whether', but: there would be *no sense* in speaking in this context of the same or different places. And since in reality it has a sense, this isn't the structure of our visual field. The genuine criterion for the structure is precisely which propositions make sense for it--not, which are true. To look for these is the method of philosophy.

Page 256

We might also put it like this: let's suppose that a set of coordinate axes once flared up in our visual field for a few moments and disappeared again, provided our memory were good enough, we could then establish the orientation of every subsequent image by reference to our memory of the axes. If there were no absolute direction, this would be logically impossible.

Page 256

But that means we have the possibility of describing a possible location and so a position--in the visual field, without referring to anything that happens to be there at the time. Thus we can for instance say that something can be at the top on the right, etc.

Page 256

(The analogy with a curved surface would be to say something like: a patch on an egg can be located near the broad end.)

Page 256

I can obviously see the sign V at one time as a v, at another as an A, as a 'greater than' or 'less than' sign, even if I were to see it

Page Break 257

through a telescope and cannot compare its position with the position of my body.

Page 257

Perhaps someone might reply that I feel the position of my body without seeing it. But position in feeling space (as I'd like to put it for once) has nothing to do with position in visual space, the two are independent of each other, and unless there were absolute direction in visual space, you couldn't correlate direction in feeling space with it at all.

Page 257

207 Now, can I say something like: The top half of my visual field is red? And what does that mean? Can I say that an object (the top half) has the property of being red?

Page 257

In this connection, it should be remembered that every part of visual space *must* have a colour, and that

every colour *must* occupy a part of visual space. The forms *colour* and *visual space* permeate one another.

Page 257

It is clear that there isn't a relation of 'being situated' which would hold between a colour and a position, in which it 'was situated'. There is no intermediary between colour and space.

Page 257

Colour and space saturate one another.

Page 257

And the way in which they permeate one another makes up the visual field.

Page 257

208 It seems to me that the concept of distance is given immediately in the structure of visual space. Were it not so, and the concept of distance only associated with visual space by means of a correlation between a visual space without distance and another structure that contained distance, then the case would be conceivable in which, through an alteration in this association, the length *a*, for example, will appear greater than the length *b*, even though we still observe the point B as always between A and C.

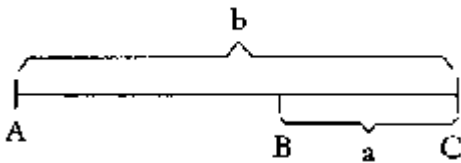

Page Break 258

Page 258

How about when we measure an object in visual space with a yardstick *for a time*? Is it also measured when the yardstick isn't there?

Page 258

Yes, if any sense can be made at all of establishing the identity between what was measured and what is not.

Page 258

If I can say: 'I have measured *this* length and it was three times as long as *that*', then it makes sense and it is correct to say that the lengths are still in the same relationship to one another now.

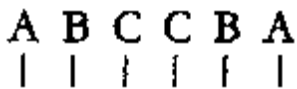

Page 258

'CC between AA' follows from 'CC between BB', but only if the partition is really given, through colour boundaries.

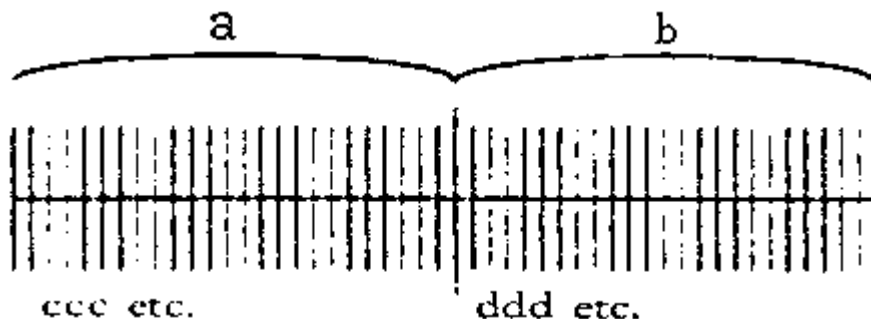

Page 258

It is obviously possible for the intervals *a* and *b* to appear to me to be the same in length and for the segments *c* and the segments *d* also to appear to me to be the same in length but for there still to be 25 *cs* and 24 *ds* when I count them. And the question arises: how can that be possible? Is it correct to say here: but it is so, and all we see is that visual space does not obey the rules of--say--Euclidean space? This would imply that the question 'How can that be possible?' was nonsense and so unjustified. And so there wouldn't be anything paradoxical in this at all, we would simply have to accept it. But is it *conceivable* that *a* should appear equal to *b* and the *cs* to the *ds*, and a *visibly* different number of *cs* and *ds* be present?

Page 258

Or should I now say that even in visual space something can after all *appear* different from what it *is*? Certainly not! Or that n times an interval and $n + 1$ times the same interval can yield

Page Break 259

precisely the same result in visual space? That is just as unacceptable. Except if there is no sense at all in saying of intervals in visual space that they *are* equal. If, that is, in visual space it only made sense to talk of a 'seeming' and this expression weren't only appropriate for the relationship between two independent experiences. And so if there were an *absolute* seeming.

Page 259

And so perhaps also an *absolute* vagueness or an *absolute* unclarity. (Whereas on my view, something can only be vague or unclear with reference to something we have posited as the standard of clarity: therefore relatively.)

Page 259

Can't I then--in the first case--if I can't take in the number at a glance, make a mistake in determining this number? Or: are a and b composed of a number of parts at all--in the ordinary sense--if I can't *see* this number in a and b ? For it certainly seems I've no right at all to *conclude* that the same number of c s and of d s must be present. And this still holds, even if counting really does yield the same number! I mean: even if counting were never to yield different results where a and b are equal etc.

Page 259

(This shows, incidentally, how difficult it is to describe what it is that we really see.)

Page 259

But suppose we have the right to talk of a number of parts--N.B. remaining throughout at the purely visual level--even when we don't see the number immediately; then the question would arise: can I in that case be sure that what I count is really the number I see or rather whose visual result I see? Could I be sure that the number of parts doesn't instantaneously change from 24 to 25 without my noticing it?

Page 259

If I see $a = b$ and $c = d$ and someone else counts the parts and finds the numbers equal, I shall at least feel that that doesn't contradict what I see. But I am also aware that I can see the same when there are 25 c s in a and 24 d s in b . From this I can conclude that I don't notice when there's one part more or one less, and

Page Break 260

therefore also cannot notice if the number of parts in b changes between 24 and 25.

Page 260

209 But if you can't say that there is a definite number of parts in a and b , how am I in that case to describe the visual image? Here it emerges--I believe--that the visual image is much more complicated than it seems to be at first glance. What makes it so much more complicated is e.g. the factor introduced by eye movements.

Page 260

If--say--I were to describe what is seen at a glance by painting a picture instead of using the language of words, then I ought not really to paint all the parts c and d . In many places I should have to paint something 'blurred' instead, i.e. a grey section.

Page 260

'Blurred' [†1] and 'unclear' are relative expressions. If this often doesn't seem to be so, that results from the fact that we still know too little of the real nature of the given phenomena, that we imagine them as more primitive than they are. Thus it is, e.g., possible that no coloured picture of any kind whatever is able to represent the impression of 'blurredness' correctly. But it doesn't follow from that that the visual image is blurred in itself and so can't be represented by any kind of definite picture whatever. No, this would only indicate that a factor plays a part in the visual image--say through eye movements--which admittedly can't be reproduced by a painted picture, but which is in itself as 'definite' as any other. You might in that case say, what is really given is still always indefinite or blurred relative to the painted picture, but merely because we have in that case made the painted picture arbitrarily into a standard for the given, when this has a greater multiplicity than that of a painted representation.

Page 260

It[[sic]] we were really to *see* 24 and 25 parts in a and b , we couldn't then see a and b as equal.

Page 260

If this is wrong, the following must be possible: it ought to be possible to distinguish immediately between the cases where a

Page Break 261

and b both equal 24 and the case where a is 24 and b 25, but it would only be possible to distinguish between the number of parts, and not between the lengths of a and b that result.

Page 261

We might also put this more simply thus: it would then have to be possible to see immediately that one interval is made up of 24 parts, the other of 25, without it being possible to distinguish the resulting lengths.--I believe that the word 'equal' has a meaning even for visual space which stamps this as a contradiction.

Page 261

Do I tell that two intervals of visual space are equal by not telling that they are unequal? This is a question with far-reaching implications.

Page 261

Couldn't I have two impressions in succession: in one, an interval visibly divided into 5 parts, in the other one visibly divided in the same way into 6 parts, while I yet couldn't say that I had seen the parts or the entire intervals as having different lengths?

Page 261

Asked 'Were the intervals different in length or the same?' I couldn't answer 'I saw them as different in length', since no difference in length has so to speak 'struck' me. And yet I couldn't --I believe--say that I saw them as equal in length. On the other hand, I couldn't say either: 'I don't know whether they were the same or different in length' (unless my memory had deserted me), for that means nothing so long as I go on talking only of the immediately given.

Page 261

210 The question is, how to explain certain contradictions that arise when we apply the methods of inference used in Euclidean space to visual space.

Page 261

I mean: it is possible to carry through a construction (i.e. a chain of inference) in visual space in which we appreciate every step (transition), but whose result contradicts our geometrical concepts.

Page Break 262

Page 262

Now I believe this happens because we can only see the construction piecemeal and not as one whole. The explanation would then consist in saying that there isn't a visual construction at all that is composed of these individual visual pieces. This would be something like what happens when I show someone a small section of a large spherical surface and ask him whether he accepts the great circle which is visible on it as a straight line; and if he did so, I would then rotate the sphere and show him that it came back to the same place on the circle. But I surely haven't proved to him in this way that a straight line in visual space returns to meet itself.

Page 262

This explanation would be: these are visual *pieces* which do not, however, add up to a visual whole, or at any rate not to the whole the final result of which I believe I can see at the end.

Page 262

The simplest construction of this sort would, indeed, be the one above of the two equally long intervals into one of which a piece will go n times and into the other $n + 1$ times. The steps of the construction would lie in proceeding from one component part to another and discovering the equality of these parts.

Page 262

Here you could explain that, in making this progression, I am not really investigating the original visual image of the equally long intervals. But that something else obtrudes into the investigation, which then leads to the startling result.

Page 262

But there's an objection to this explanation. Someone might say: we didn't hide any part of the construction from you while you were examining the individual parts, did we? So you ought to have been able to see whether anything about the rest changed, shifted in the meantime. If that didn't happen, then you really ought to be able to see, oughtn't you, that everything was above board?

Page 262

To speak of divisibility in visual space has a sense, since in a description it must be possible to substitute a divided stretch for

Page Break 263

an undivided one. And then it is clear what, in the light of what I elaborated earlier, the infinite divisibility of this space means.

211 The moment we try to apply exact concepts of measurement to immediate experience, we come up against a peculiar vagueness in this experience. But that only means a vagueness relative to these concepts of measurement. And, now, it seems to me that this vagueness isn't something provisional, to be eliminated later on by more precise knowledge, but that this is a characteristic logical peculiarity. If, e.g., I say: 'I can now see a red circle on a blue ground and remember seeing one a few minutes ago that was the same size or perhaps a little smaller and a little lighter,' then *this* experience cannot be described more precisely.

Admittedly the words 'rough', 'approximate' etc. have only a relative sense, but they are still *needed* and they characterise the nature of our experience; not as rough or vague in itself, but still as rough and vague in relation to our techniques of representation.

This is all connected with the problem 'How many grains of sand make a heap?'

You might say: any group with more than a hundred grains is a heap and less than ten grains do not make a heap: but this has to be taken in such a way that ten and a hundred are not regarded as limits which could be essential to the concept 'heap'.

And this is the same problem as the one specifying which of the vertical strokes we first notice to have a different length from the first.

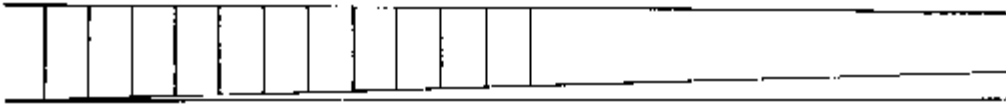

What corresponds in Euclidean geometry to the visual circle isn't a circle, but a class of figures, including the circle, but also, e.g., the hundred-sided regular polygon. The defining characteristic of this class could be something like their all being figures

contained in a band which arises through the vibration of a circle.--But even that is wrong: for why should I take precisely the band which arises from vibrating a circle and not that produced by vibrating the hundred-sided polygon?

And here I come up against the cardinal difficulty, since it seems as though an exact *demarcation* of the inexactitude is impossible. For the demarcation is arbitrary, since how is what corresponds to the vibrating circle distinguished from what corresponds to the vibrating hundred-sided polygon?

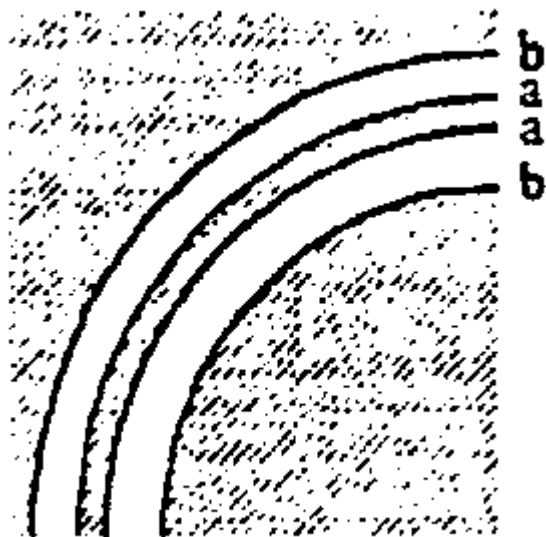

There is something attractive about the following explanation: everything that is within a appears as the visual circle C , everything that is outside b does not appear as C . We would then have the case of the word 'heap'. There would be an indeterminate zone left open, and the boundaries a and b are not essential to the concept defined.--The boundaries a and b are still only like the walls of the *forecourts*. They are drawn arbitrarily at a point where we can still draw something firm.--Just as if we were to border off a swamp with a wall, where the wall is not *the* boundary of the swamp, it only stands around it on firm ground. It is a sign which shows there is a swamp inside it, but not, that the swamp is exactly the same size as that of the surface bounded by it.

Page Break 265

Page 265

212 Now isn't the correlation between visual space and Euclidean space as follows: no matter what Euclidean figure I show to the observer, he must be able to distinguish whether or not it is the visual circle C . That is to say, by constantly reducing the interval between the figures shown I shall be able to reduce the indeterminate interval indefinitely, be able 'to approach indefinitely close to a limit between what I see as C and what I see as not C '.

Page 265

But on the other hand, I shall never be able to draw such a limit as a curve in Euclidean space, for if I could, it would itself then have to belong to one of the two classes and be the last member of this class, in which case I would have to be able to see a Euclidean curve after all.

Page 265

If someone says e.g. that we never see a real circle but always only approximations to one, this has a sound, unobjectionable sense, if it means that, given a body which looks circular, we can still always discover inaccuracies by precise measurement or by looking through a magnifying glass. But we lose this sense the moment we substitute the immediately given, the patch or whatever we choose to call it, for the circular body.

Page 265

If a circle is at all the sort of thing that we see--see in the same sense as that in which we see a blue patch--then we must be able to see it and not merely something like it.

Page 265

If I cannot see an exact circle then in this sense neither can I see approximations to one.--But then the Euclidean circle--and the Euclidean approximation to one--is in this sense not an object of my perception at all, but, say, only a different logical construction which could be obtained from the objects of a quite different space from the space of immediate vision.

Page 265

But even this way of talking is misleading, and we must rather say that we see the Euclidean circle in a different sense.

Page 265

And so that a different sort of projection exists between the

Page Break 266

Euclidean circle and the circle perceived than one would naïvely suppose.

Page 266

If I say you can't distinguish between a chiliagon and a circle, then the chiliagon must here be given through its construction, its origin. For how else would I know that it is 'in fact' a chiliagon and *not* a circle?

Page 266

In visual space there is no measurement.

Page 266

We could, e.g., perfectly well give the following definitions for visual space: 'A straight line is one that isn't curved' and 'A circle is a curve with constant curvature'.

Page 266

213 We need new concepts and we continually resort to those of the language of physical objects. The word 'precision' is one of these dubious expressions. In ordinary language it refers to a *comparison* and then it is quite intelligible. Where a certain degree of imprecision is present, perfect precision is also possible. But what is it supposed to mean when I say I can never see a precise circle, and am now using this word not relatively, but absolutely?

Page 266

The words 'I see' in 'I see a patch' and 'I see a line' therefore have different meanings.

Page 266

Suppose I have to say 'I never see a perfectly sharp line'. I have then to ask 'Is a sharp line conceivable?' If it

is right to say 'I do not see a sharp line', than a sharp line *is* conceivable. If it makes sense to say 'I never see an exact circle', then this implies: an exact circle is conceivable in visual space.

Page 266

If an exact circle in a visual field is inconceivable, the proposition 'I never see an exact circle in my visual field' must be the same sort of proposition as 'I never see a high C in my visual field'.

Page 266

If I say 'The upper interval is as long as the lower' and mean by this what is usually said by the proposition 'the upper interval

Page Break 267

appears to me as long as the lower', then the word 'equal' [†1] means something quite different in this proposition from what it means in the proposition expressed in the same words but which is verified by comparing lengths with dividers. For this reason I can, e.g., speak in the latter case of improving the techniques of comparison, but not in the former. The use of the same word 'equal' with quite different meanings is very confusing. This is the typical case of words and phrases which originally referred to the 'things' of the idioms for talking about physical objects, the 'bodies in space', being applied to the elements of our visual field; in the course of this they inevitably change their meanings utterly and statements which previously had had a sense now lose it and others which had had no sense in the first way of speaking now acquire one. Even though a certain analogy does persist--just the one which tricks us into using the same expression.

Page 267

It is, e.g., important that the word 'close' means something different in the proposition 'There is a red patch close to the boundary of the visual field' and in such a proposition as 'The red patch in the visual field is close to the brown one'. Furthermore the word 'boundary' in the first proposition also has a different meaning--and is a different sort of word from 'boundary' in the proposition: 'the boundary between red and blue in the visual field is a circle'.

Page 267

What sense does it make to say: our visual field is less clear at the edges than towards the middle? That is, if we aren't here talking about the fact that we see physical objects more clearly in the middle of the visual field?

Page 267

One of the clearest examples of the confusion between physical and phenomenological language is the picture Mach [†2] made of his visual field, in which the so-called blurredness of the figures near the edge of the visual field was reproduced by a blurredness (in a quite different sense) in the drawing. No, you can't make a visual picture of our visual image.

Page Break 268

Page 268

Can I therefore say that colour patches near the edge of the visual field no longer have sharp contours: are contours then *conceivable* there? I believe it is clear that this lack of clarity is an internal property of visual space. Has, e.g., the word 'colour' a different meaning when it refers to figures near to the edge?

Page 268

Without this 'blurredness' the limitlessness of visual space isn't conceivable.

Page 268

214 The question arises what distinctions are there in visual space. Can we learn anything about this from the co-ordination, e.g., of tactile space with visual space? Say, by specifying which changes in one space do not correspond to a change in the other?

Page 268

The fact that you see a physical hundred-sided polygon as a circle--cannot distinguish it from a physical circle--implies nothing here as to the *possibility* of seeing a hundred-sided polygon.

Page 268

That it proves impossible for me to find physical bodies which give the visual image of a hundred-sided visual polygon is of no significance for logic. The question is: is there a *sense* in speaking of a hundred-sided polygon? Or: Does it make sense to talk of thirty strokes in a row *taken in at one look*? I believe there is none.

Page 268

The process isn't at all one of seeing first a triangle, then a square, pentagon etc. up to e.g. a fifty-sided polygon and then the circle coming; no[[sic]] we see a triangle, a square etc., up to, maybe, an octagon, then we see only polygons with sides of varying length. The sides get shorter, then a fluctuation towards the circle begins, and then comes the circle.

Neither does the fact that a physical straight line drawn as a tangent to a circle gives the visual image of a straight line which for a stretch merges with the curve prove that our visual space isn't Euclidean, for a different physical configuration could perfectly well produce the image corresponding to the Euclidean tangent. But in fact such an image is inconceivable.

215 What is meant by the proposition 'We never see a precise circle'? What is the criterion of precision? Couldn't I also perfectly well say: 'Perhaps I see a precise circle, but can never know it'? All this only makes sense, once it has been established in what cases one calls one measurement more precise than another. Now the concept of a circle presupposes--I believe--a concept of 'greater precision', which contains an infinite possibility of being increased. And we may say the concept of a circle *is* the concept of the infinite possibility of greater precision. This infinite possibility of increase would be a postulate of this idiom. Of course, it must then be clear in every case what I would regard as an increase in precision.

It obviously means nothing to say the circle is only an ideal to which reality can only approximate. This is a misleading metaphor. For you can only approximate to something that is there, and if the circle is given us in any form that makes it possible for us to approximate, then precisely that form would be the important thing for us, and approximation to another form in itself of secondary importance. But it may also be that we call an infinite possibility itself, a circle. So that the circle would then be in the same position as an irrational number.

It seems essential to the application of Euclidean geometry that we talk of an *imprecise* circle, an imprecise *sphere* etc. And also that this imprecision must be logically susceptible of an unlimited reduction. And so, if someone is to understand the application of Euclidean geometry, he has to know what the word '*imprecise*' means. For nothing is given us over and above the result of our measuring and the concept of imprecision. These two together must correspond to Euclidean geometry.

Now, is the imprecision of measurement the same concept as the imprecision of visual images? I believe: Certainly not.

If the assertion that we never *see* a precise circle is supposed to mean, e.g., that we never see a straight line touch a circle at one point (i.e. that nothing in our visual space has the multiplicity of a

line touching a circle), then for *this* imprecision, an indefinitely high degree of precision is not conceivable.

The word 'equality' has a different meaning when applied to intervals in visual space and when applied in physical space. Equality in visual space has a different multiplicity from equality in physical space, so that in visual space g_1 and g_2 can be straight

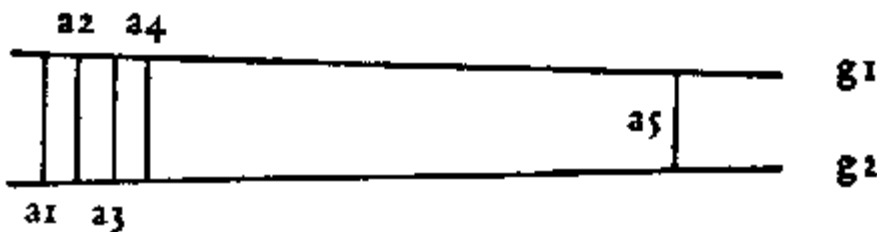

lines (visually straight) and the lengths $a_1 = a_2, a_2 = a_3$ etc., but *not* $a_1 = a_5$. Equally, a circle and a straight line in visual space have a different multiplicity from a circle and a straight line in physical space, for a short stretch of a seen circle can be straight; 'circle' and 'straight line' simply used in the sense of visual geometry.

Here ordinary language resorts to the words 'seems' or 'appears'. It says a_1 seems to be equal to a_2 , whereas this appearance has ceased to exist in the case of a_1 and a_5 . But it uses the word 'seems' ambiguously. For its meaning depends on what is opposed to this appearance as reality. In one case it is the result of measurement, in another a further appearance. And so the meaning of the word 'seem' is different in these two cases.

216 The time has now come to subject the phrase 'sense-datum' to criticism. A sense-datum is the appearance of this

tree, whether 'there really is a tree standing there' or a dummy, a mirror image, an hallucination, etc. A sense-datum is the appearance of the tree, and what we want to say is that its representation in language is only *one* description, but not *the* essential one. Just as you can say of the expression '*my* visual image' that it is only one form of description, but by no means the only possible and correct one. For the form of words 'the appearance of this tree' incorporates

Page Break 271

the idea of a necessary connection between what we are calling the appearance and 'the existence of a tree', in fact whether it be veridical perception or a mistake. That is to say, if we talk about 'the appearance of a tree', we are either taking for a tree something which is one, or something which is not one. But this connection isn't there.

Page 271

Idealists would like to reproach language with presenting what is secondary as primary and what is primary as secondary. But that is only the case with these inessential valuations which are independent of cognition ('only' an appearance). Apart from that, ordinary language makes no decision as to what is primary or secondary. We have no reason to accept that the expression 'the appearance of a tree' represents something which is secondary in relation to the expression 'tree'. The expression 'only an image' goes back to the idea that we can't eat the image of an apple.

Page 271

217 We might think that the right model for visual space would be a Euclidean drawing-board with its ideally fine constructions which we make vibrate so that all the constructions are to a certain extent blurred (further, the surface vibrates equally in all the directions lying in it). We could in fact say: it is to be vibrated precisely as far as it can without its yet being noticeable, and then its physical geometry will be a picture of our phenomenological geometry.

Page 271

But the big question is: Can you translate the 'blurredness' of phenomena into an imprecision in the drawing? It seems to me that you can't.

Page 271

It is, for instance, impossible to represent the imprecision of what is immediately seen by thick strokes and dots in the drawing.

Page 271

Just as we cannot represent the memory of a picture by this picture painted in faint colours. The faintness of memory is something quite other than the faintness of a hue we see; and the unclarity of vision different *in kind* from the blurredness of an

Page Break 272

imprecise drawing. (Indeed, an imprecise drawing is seen with precisely the unclarity we are trying to represent by its imprecision.)

Page 272

(In films, when a memory or dream is to be represented, the pictures are given a bluish tint. But memory images have no bluish tint, and so the bluish projections are not visually accurate pictures of the dream, but pictures in a sense which is not immediately visual.)

Page 272

A line in the visual field need not be either straight or curved. Of course the third possibility should not be called 'doubtful' (that is nonsense); we ought to use another word for it, or rather replace the whole way of speaking by a different one.

Page 272

That visual space isn't Euclidean is already shown by the occurrence of two different kinds of lines and points: we see the fixed stars as points: that is, we can't see the contours of a fixed star, and in a different sense two colour boundaries also intersect in a point; similarly for lines. I can see a luminous line without thickness, since otherwise I should be able to see a cross-section of it as a rectangle or at least the four points of intersection of its contours.

Page 272

A visual circle and a visual straight line can have a stretch in common.

Page 272

If I look at a drawn circle with a tangent, it wouldn't be remarkable that I never see a perfect circle and a perfect straight line touch one another, it only becomes interesting when I see this happen, and the straight line and the circle then coincide for a stretch.

Page 272

For only that would imply that the visual circle and the visual line are essentially different from the circle and

line of Euclidean geometry; but the first case, that we have never seen a perfect circle and a perfect line touch one another, would not.

Page Break 273

XXI

Page 273

218 There appear to be simple colours. Simple as psychological phenomena. What I need is a psychological or rather phenomenological colour theory, not a physical and equally not a physiological one.

Page 273

Furthermore, it must be a theory in *pure* phenomenology in which mention is only made of what is actually perceptible and in which no hypothetical objects--waves, rods, cones and all that--occur.

Page 273

Now, we can recognize colours as mixtures of red, green, blue, yellow, white and black *immediately*. Where this is still always the colour itself, and not pigment, light, process on or in the retina, etc.

Page 273

We can also see that one colour is redder than another or whiter, etc. But can I find a metric for colours? Is there a sense in saying, for instance, that with respect to the amount of red in it one colour is *halfway* between two other colours?

Page 273

At least there seems to be a sense in saying that one colour is closer in this respect to a second than it is to a third.

Page 273

219 You might say, violet and orange partially obliterate one another when mixed, but not red and yellow.

Page 273

At any rate orange is a mixture of red and yellow in a sense in which yellow isn't a mixture of red and green, although yellow comes between red and green in the colour circle.

Page 273

And if that happens to be manifest nonsense, the question arises, at what point does it begin to make sense; that is, if I now move on the circle from red and from green towards yellow and call yellow a mixture of the two colours I have now reached.

Page 273

That is, in yellow I recognize an affinity with red and with green, viz. the possibility of reddish yellow--and yet I still don't

Page Break 274

recognize green and red as component parts of yellow in the sense in which I recognize red and yellow as component parts of orange.

Page 274

I want to say that red is between violet and orange only in the sense in which white is between pink and greenish-white. But, in this sense, isn't any colour between any two other colours, or at least between any two which may be reached from the first by independent routes?

Page 274

Can one say that in this sense a colour only lies between two others with reference to a specified continuous transition? And so, say, blue between red and black?

Page 274

Is this then how it is: to say the colour of a patch is a mixture of orange and violet is to ascribe to it a different colour from that ascribed by saying that the patch has the colour common to violet and orange?--But that won't work either; for, in the sense in which orange is a mixture of red and yellow, there isn't a mixture of orange and violet at all. If I imagine mixing a blue-green with a yellow-green, I see straightaway that it can't happen, that, on the contrary, a component part would first have to be 'killed' before the union could occur. This isn't the case with red and yellow. And in this I don't have an image of a continuous transition (via green), only the discrete hues play a part here.

Page 274

220 I must know what in general is meant by the expression 'mixture of colours A and B', since its application isn't limited to a finite number of pairs. Thus if, e.g., someone shows me any shade of orange and a white and says the colour of a patch is a mixture of these two, then I must understand this, and I can understand it.

Page 274

If someone says to me that the colour of a patch lies between violet and red, I understand this and can imagine a redder violet than the one given. If, now, someone says to me the colour lies between this violet and an orange--where I don't have a specific continuous transition before me in the shape of a painted colour circle--then I can at best think that here, too, a redder violet is meant, but a redder orange might also be what is meant, since,

Page Break 275

leaving on one side a given colour circle, there is no colour lying *halfway* between the two colours, and for just this reason neither can I say at what point the orange forming one limit is already too close to the yellow for it still to be mixed with the violet; the point is that I can't tell which orange lies at a distance of 90° from violet on the colour circle. The way in which the mixed colour lies between the others is no different here from the way red comes between blue and yellow.

Page 275

If I say in the ordinary sense that red and yellow make orange, I am not talking here about a *quantity* of the components. And so, given an orange, I can't say that yet *more* red would have made it a redder orange (I'm not of course speaking about pigments), even though there is of course a sense in speaking of a redder orange. But there is, e.g., no sense in saying this orange and this violet contain the same amount of red. And how much red would *red* contain?

Page 275

The comparison we are seduced into making is one between the colour series and a system of two weights on the beam of a balance, where I can move the centre of gravity of the system just as I choose, by increasing or moving the weights.

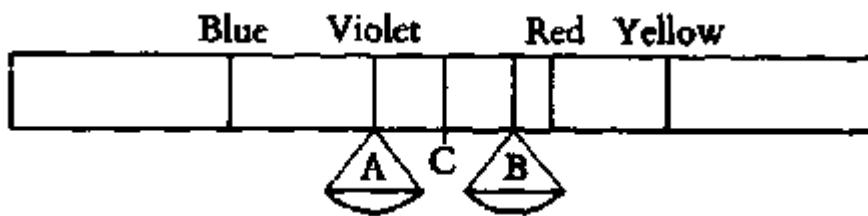

Page 275

Now it's nonsense to believe that if I held the scale A at violet and moved the scale B into the red-yellow region, C will then move towards red.

Page 275

And what about the weights I put on the scales: Does it mean anything to say, '*more of this* red'? when I'm not talking about pigments. That can only mean something if I understand by pure red a number of units, where the number is stipulated at the outset. But then the complete number of units means nothing but that the

Page Break 276

scale is standing at red. And so the relative numbers again only specify a point on the balance, and not a point and a weight.

Page 276

Now so long as I keep my two end colours in say, the blue-red region, and move the redder colour, I can say that the resultant also moves towards red. But if I move one end-colour beyond red, and move it towards yellow, the resultant doesn't now become redder! Mixing a yellowish red with a violet doesn't make the violet redder than mixing pure red with the violet. That the one red has now become yellower even takes away something of the red and doesn't add red.

Page 276

We could also describe this as follows: if I have a paint pot of violet pigment and another of orange, and now increase the amount of orange added to the mixture, the colour of the mixture will gradually move away from violet towards orange, but not via pure red.

Page 276

I can say of two different shades of orange that I have no grounds for saying of either that it is closer to red than yellow.--There simply isn't a 'midpoint' here.--On the other hand, I can't see two different reds and be in doubt whether one of them, and if so which, is pure red. That is because pure red is a point, but the midway between red and yellow isn't.

Page 276

221 Admittedly it's true that we can say of an orange that it's almost yellow, and so that it is 'closer to yellow than to

red' and analogously for an almost red orange. But it doesn't follow from this that there must also be a midpoint between red and yellow. Here the position is just as it is with the geometry of visual space as compared with Euclidean geometry. There are here quantities of a different sort from that represented by our rational numbers. The concepts 'closer to' and 'further from' are simply of no use at all or are misleading when we apply these phrases.

Page Break 277

Page 277

Or again: to say of a colour that it lies between red and blue doesn't define it sharply (unambiguously). But the pure colours must be defined *unambiguously* when it is stated that they lie between certain mixed colours. And so the phrase 'lie between' means something *different* from what it meant in the first case. That is to say, if the expression 'lie between' on one occasion designates a mixture of two simple colours, and on another a simple component common to two mixed colours, the multiplicity of its application is different in the two cases. And this is *not* a difference in degree, it's an expression of the fact that we are dealing with two entirely different categories.

Page 277

We say a colour can't be between green-yellow and blue-red in the same sense as between red and yellow, but we can only say this because in the latter case we can distinguish the angle of 90° ; because we see yellow and red as *points*. But there simply is no such distinguishing in the other case where the mixed colours are regarded as primary. And so in this case we can, so to speak, never be certain whether the mixture is still possible or not. To be sure, I could choose mixed colours at random and stipulate that they include an angle of 90° ; but this would be completely arbitrary, whereas it isn't arbitrary when we say that in the first sense there is no mixture of blue-red and green-yellow.

Page 277

So in the one case grammar yields the 'angle of 90° ', and now we are misled into thinking: we only need to bisect it and the adjacent segment too, to arrive at another 90° segment. But here the *metaphor* of an angle collapses.

Page 277

Of course you can also arrange all the shades in a straight line, say with black and white as endpoints, as has been done, but then you have to introduce rules to exclude certain transitions, and in the end the representation on the line must be given the same kind of topological structure as the octahedron has. In this, it's completely analogous to the relation of ordinary language to a 'logically purified' mode of expression. The two are completely equivalent;

Page Break 278

it's just that one of them already wears the rules of grammar on its face.

Page 278

To what extent can you say that grey is a mixture of black and white *in the same sense* as orange is a mixture of red and yellow? And doesn't lie between black and white in the sense in which red lies between blue-red and orange?

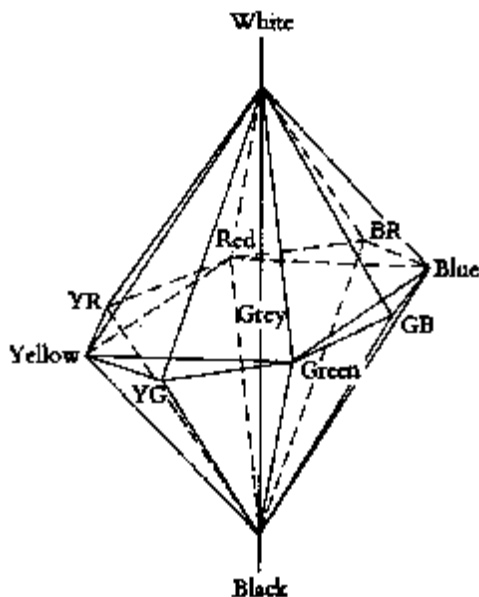

Page 278

If we represent the colours by means of a double-cone, instead of an octahedron, there is only one *between* on the colour circle, and red appears on it between blue-red and orange in the same sense as that in which blue-red lies between blue and red. And if in fact that is all there is to be said, then a representation by means of a

double-cone is adequate, or at least one using a double eight-sided pyramid is.

Page 278

222 Now strangely enough, it seems clear from the outset that we can't say red has an orange tinge in the same sense as orange

Page Break 279

has a reddish tinge. That is to say, it seems to be clear that the phrases 'x is composed of (is a mixture of) y and z' and 'x is the common component of y and z' are not interchangeable here: Were they so, the relation *between* would be all we needed for a representation.

Page 279

In general, the phrases 'common component of' and 'mixture of' have different meanings only if one can be used in a context where the other can't.

Page 279

Now, it's irrelevant to our investigation that when I mix blue and green pigments I get a blue-green, but when I mix blue-green and blue-red the result isn't a blue.

Page 279

If I am right in my way of thinking, then 'Red is a pure colour' isn't a proposition, and what it is meant to show is not susceptible to experimental testing. So that it is inconceivable that at one time red and at another blue-red should appear to us to be pure.

Page 279

223 Besides the transition from colour to colour on the colour-circle, there seems to be another specific transition that we have before us when we see dots of one colour intermingled with dots of another. Of course I mean here a *seen* transition.

Page 279

And this sort of transition gives a new meaning to the word 'mixture', which doesn't coincide with the relation 'between' on the colour-circle.

Page 279

You might describe it like this: I can imagine an orange-coloured patch as having arisen from intermingling red and yellow dots, whereas I can't imagine a red patch as having arisen from intermingling violet and orange dots.--In this sense, grey is a mixture of black and white, but white isn't a mixture of pink and a whitish green.

Page 279

But I don't mean that it is established by experimental mixing that certain colours arise in this way from others. I could, say,

Page Break 280

perform the experiment with a rotating coloured disc. Then it might work or might not, but that will only show whether or not the visual process in question can be produced by these physical means--it doesn't show whether the process is possible. Just as physical dissection of a surface can neither prove nor refute visual divisibility. For suppose I can no longer see a physical dissection as a visual dissection, but when drunk see the undivided surface as divided, then wasn't the visual surface divisible?

Page 280

If I am given two shades of red, say, which are close to one another, it's impossible to be in doubt whether both lie between red and blue, or both between red and yellow, or one between red and blue and the other between red and yellow. And in deciding this, we have also decided whether both will mix with blue or with yellow, or one with blue and one with yellow, and this holds no matter how close the shades are brought together so long as we are still capable of distinguishing the pigments by colour at all.

Page 280

If we ask whether the musical scale carries with it an infinite possibility of being continued, then it's no answer to say that we can no longer perceive vibrations of the air that exceed a certain rate of vibration as notes, since it might be possible to bring about sensations of higher notes in another way. Rather, the finitude of the musical scale can only derive from its internal properties. For instance, from our being able to tell from a note *itself* that it is the final one, and so that this last note, or the last notes, exhibit inner properties which the notes in between don't have.

Page 280

Just as thin lines in our visual field exhibit internal properties not possessed by the thicker ones, so that there is a line in our visual field, which isn't a colour boundary but is itself coloured, and yet in a specific sense has no breadth, so that when it intersects another such line we do not see four points A, B, C, D.

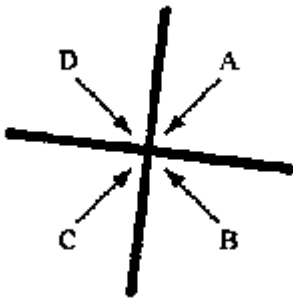

224 Nowadays the danger that lies in trying to see things as simpler than they really are is often greatly exaggerated. But this danger does actually exist to the highest degree in the phenomenological investigation of sense impressions. These are always taken to be *much* simpler than they are.

If I see that a figure possesses an organization which previously I hadn't noticed, I now see a different figure. Thus I can see ||||| as a special case of || || || or of ||| ||| or of | |||| | etc. This merely shows that that which we see isn't as simple as it appears.

Understanding a Gregorian mode doesn't mean getting used to the sequence of notes in the sense in which I can get used to a smell and after a while cease to find it unpleasant. No, it means hearing something new, which I haven't heard before, much in the same way--in fact it's a complete analogy--as it would be if I were suddenly able to see 10 strokes |||||, which I had hitherto only been able to see as twice five strokes, as a characteristic whole. Or suddenly seeing the picture of a cube as 3-dimensional when I had previously only been able to see it as a flat pattern.

The limitlessness of visual space stands out most clearly, when we can see nothing, in pitch-darkness.

XXII

225 A proposition, an hypothesis, is coupled with reality--with varying degrees of freedom. In the limit case there's no longer any connection, reality can do anything it likes without coming into conflict with the proposition: in which case the proposition (hypothesis) is senseless!

All that matters is that the signs, in no matter how complicated a way, still in the end refer to immediate experience and not to an intermediary (a thing in itself).

All that's required for our propositions (about reality) to have a sense, is that our experience *in some sense or other* either tends to agree with them or tends not to agree with them. That is, immediate experience need confirm only something about them, *some* facet of them. And in fact this image is taken straight from reality, since we say 'There's a chair here', when we only see *one* side of it.

According to my principle, two assumptions must be identical in sense if every possible experience that confirms the one confirms the other too. Thus, if no empirical way of deciding between them is conceivable.

A proposition construed in such a way that it can be uncheckably true or false is completely detached from reality and no longer functions as a proposition.

The views of modern physicists (Eddington) tally with mine completely, when they say that the signs in their equations no longer have 'meanings', and that physics cannot attain to such meanings but must stay put at the signs. But they don't see that these signs have meaning in as much as--and only in as much

as--immediately observable phenomena (such as points of light) do or do not correspond to them.

A phenomenon isn't a symptom of something else: it is the reality.

Page 283

A phenomenon isn't a symptom of something else which alone makes the proposition true or false: it itself is what verifies the proposition.

Page 283

226 An hypothesis is a logical structure. That is, a symbol for which certain rules of representation hold.

Page 283

The point of talking of sense-data and immediate experience is that we're after a description that has nothing hypothetical in it. If an hypothesis can't be definitively verified, it can't be verified at all, and there's no truth or falsity for it [†1].

Page 283

My experience speaks in favour of the idea that *this* hypothesis will be able to represent it and future experience *simply*. If it turns out that another hypothesis represents the material of experience more simply, then I choose the simpler method. The choice of representation is a process based on so-called induction (not mathematical induction).

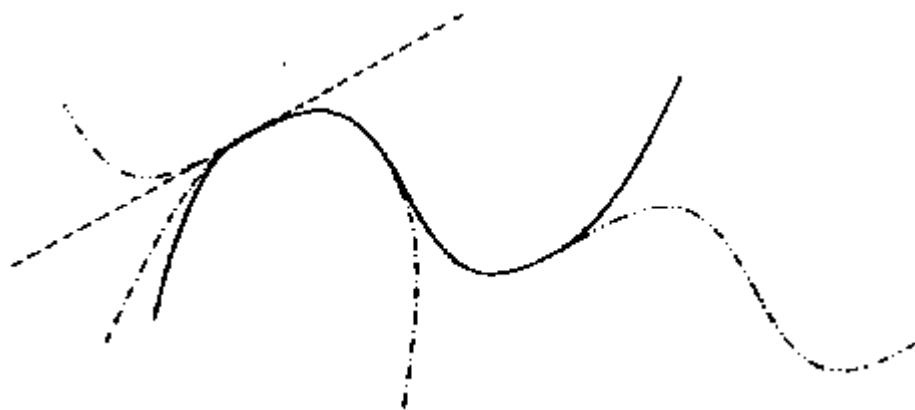

Page Break 284

Page 284

This is how someone might try to represent the course of an experience which presents itself as the development of a curve by means of various curves, each of which is based on how much of the actual course is known to us.

Page 284

The curve ----- is the actual course, so far as it is to be observed at all. The curves ---, -•••-, -••••-, show different attempts to represent it that are based on a greater or lesser part of the whole material of observation.

Page 284

227 We only give up an hypothesis for an even higher gain.

Page 284

Induction is a process based on a principle of economy.

Page 284

Any hypothesis has a connection with reality which is, as it were, looser than that of verification.

Page 284

The question, how simple a representation is yielded by assuming a particular hypothesis, is directly connected, I believe, with the question of probability.

Page 284

You could obviously explain an hypothesis by means of pictures. I mean, you could, e.g., explain the hypothesis, 'There is a book lying here', with pictures showing the book in plan, elevation and various cross-sections.

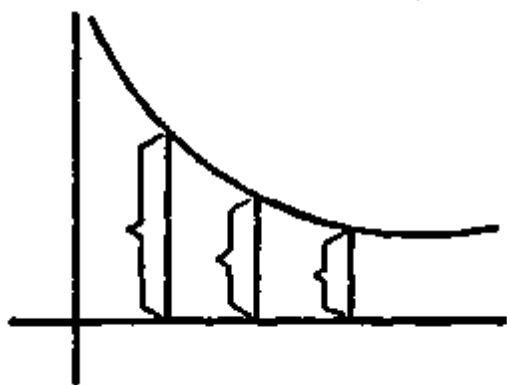

Page 284

Such a representation gives a *law*. Just as the equation of a curve gives a law, by means of which you may discover the ordinates, if you cut at different abscissae.

Page 284

In which case the verifications of particular cases correspond to cuts that have actually been made.

Page Break 285

Page 285

If our experiences yield points lying on a straight line, the proposition that these experiences are various views of a straight line is an hypothesis.

Page 285

The hypothesis is a way of representing this reality, for a new experience may tally with it or not, or possibly make it necessary to modify the hypothesis.

Page 285

228 What is essential to an hypothesis is, I believe, that it arouses an expectation by admitting of future confirmation. That is, it is of the essence of an hypothesis that its confirmation is never completed.

Page 285

When I say an hypothesis isn't definitively verifiable, that doesn't mean that there is a verification of it which we may approach ever more nearly, without ever reaching it. That is nonsense--of a kind into which we frequently lapse. No, an hypothesis simply has a different formal relation to reality from that of verification. (Hence, of course, the words 'true' and 'false' are also inapplicable here, or else have a different meaning.)

Page 285

The nature of the belief in the uniformity of events is perhaps clearest in a case where we are afraid of what we expect to happen. Nothing could persuade me to put my hand in the fire, even though it's *only in the past* that I've burnt myself.

Page 285

If physics describes a body of a particular shape in physical space, it must assume, even if tacitly, the possibility of verification. The points at which the hypothesis is connected with immediate experience must be anticipated.

Page 285

An hypothesis is a law for forming propositions.

Page 285

You could also say: An hypothesis is a law for forming expectations.

Page Break 286

Page 286

A proposition is, so to speak, a particular cross-section of an hypothesis.

Page 286

229 The probability of an hypothesis has its measure in how much evidence is needed to make it profitable to throw it out.

Page 286

It's only in this sense that we can say that repeated uniform experience in the past renders the continuation of this uniformity in the future probable.

Page 286

If, in this sense, I now say: I assume the sun will rise again tomorrow, because the opposite is so unlikely, I here mean by 'likely' and 'unlikely' something completely different from what I mean by these words in the

proposition 'It's equally likely that I'll throw heads or tails'. The two meanings of the word 'likely' are, to be sure, connected in certain ways, but they aren't identical.

Page 286

What's essential is that I must be able to compare my expectation not only with what is to be regarded as its definitive answer (its verification or falsification), but also with how things stand at present. This alone makes the expectation into a picture.

Page 286

That is to say: it must make sense *now*.

Page 286

If I say I can see, e.g., a sphere, that means nothing other than that I am seeing a view such as a sphere affords, but this only means I can construct views in accordance with a certain law--that of the sphere--and that this is such a view.

Page 286

230 Describing phenomena by means of the hypothesis of a world of material objects is unavoidable in view of its simplicity when compared with the unmanageably complicated phenomenological description. If I can see different discrete parts of a circle, it's perhaps impossible to give precise direct description of them, but the statement that they're parts of a circle, which, for reasons which haven't been gone into any further, I don't see as a whole--is simple.

Page Break 287

Page 287

Description of this kind always introduces some sort of parameter, which for our purposes we don't need to investigate.

Page 287

What is the difference between the logical multiplicity of an explanation of appearances by the natural sciences and the logical multiplicity of a description?

Page 287

If e.g. a regular ticking sound were to be represented in physics, the multiplicity of the picture

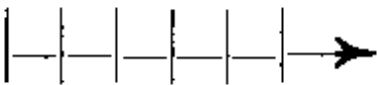

would suffice, but here it's not a question of the logical multiplicity of the sound, but of that of the regularity of the phenomenon observed. And just so, the theory of Relativity doesn't represent the logical multiplicity of the phenomena themselves, but that of the regularities observed.

Page 287

If, for instance, we use a system of co-ordinates and the equation for a sphere to express the proposition that a sphere is located at a certain distance from our eyes, this description has a greater multiplicity than that of a verification by eye. The first multiplicity corresponds not to *one* verification, but to a *law* obeyed by verifications.

Page 287

As long as someone imagines the soul as a thing, a body in our heads, there's *no* harm in the hypothesis. The harm doesn't lie in the imperfection and crudity of our models, but in their lack of clarity (vagueness).

Page 287

The trouble starts when we notice that the old model is inadequate, but then, instead of altering it, only as it were sublimate it. While I say thoughts are in my head, everything's all right; it becomes harmful when we say thoughts aren't in my head, they're in my mind.

Page 287

Whatever someone *can* mean by a proposition, he also *may* mean by it. When people say, by the proposition 'There's a chair here', I don't merely mean what is shown me by immediate experience,

Page Break 288

but something over and above that, you can only reply: whatever you can mean must connect with some sort of experience, and whatever you *can* mean is unassailable.

Page 288

231 We may compare a part of an hypothesis with the movement of a part of a gear, a movement that can be stipulated without prejudicing the intended motion. But then of course you have to make appropriate adjustments to the rest of the gear if it is to produce the desired motion. I'm thinking of a differential gear.--Once I've decided that there is to be no deviation from a certain part of my hypothesis no matter what the experience to be described may be, I have stipulated a mode of representation and this part of my hypothesis is now a postulate. A postulate must be

such that no

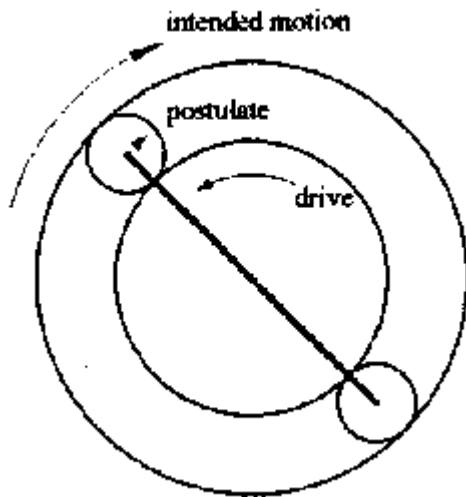

conceivable experience can refute it, even though it may be extremely inconvenient to cling to the postulate. To the extent to which we can talk here of greater or slighter convenience, there is a greater or slighter probability of the postulate.

Page Break 289

Page 289

It's senseless to talk of a measure for this probability at this juncture. The situation here is like that in the case of two kinds of numbers where we can with a certain justice say that the one is more like the other (is closer to it) than a third, but there isn't any numerical measure of the similarity. Of course you could imagine a measure being constructed in such cases, too, say by counting the postulates or axioms common to the two systems, etc., etc.

Page 289

232 We may apply our old principle to propositions expressing a probability and say, we shall discover their sense by considering what verifies them.

Page 289

If I say 'That will probably occur', is this proposition verified by the occurrence or falsified by its non-occurrence? In my opinion, obviously not. In that case it doesn't say anything about either. For if a dispute were to arise as to whether it is probable or not, it would always only be arguments from the past that would be adduced. And this would be so even when what actually happened was already known.

Page 289

If you look at ideas about probability and its application, it's always as though *a priori* and *a posteriori* were jumbled together, as if the same state of affairs could be discovered or corroborated by experience, whose existence was evident *a priori*. This of course shows that something's amiss in our ideas, and in fact we always seem to confuse the natural law we are assuming with what we experience.

Page 289

That is, it always looks as if our experience (say in the case of card shuffling) agreed with the probability calculated *a priori*. But that is nonsense. If the experience agrees with the computation, that means my computation is justified by the experience, and of course it isn't its *a priori* element which is justified, but its bases, which are *a posteriori*. But those must be certain natural laws which I take as the basis for my calculation, and it is *these* that are confirmed, not the calculation of the probability.

Page Break 290

Page 290

The calculation of the probability can only cast the natural law in a different form. It transforms the natural law. It is the medium through which we view and apply the natural law.

Page 290

If for instance I throw a die, I can apparently predict *a priori* that the 1 will occur on average once every 6 throws, and that can then be confirmed empirically. But it isn't the calculation I confirm by the experiment, but the natural law which the probability calculation can present to me in different forms. Through the medium of the probability calculation I check the natural law lying behind the calculation.

Page 290

In our case the natural law takes the form that it is equally likely for any of the six sides to be the side

uppermost. It's this law that we test.

Page 290

233 Of course this is only a natural law if it can be confirmed by a particular experiment, and also refuted by a particular experiment. This isn't the case on the usual view, for if *any* event can be justified throughout an arbitrary interval of time, then *any* experience *whatever* can be reconciled with the law. But that means the law is idling; it's senseless.

Page 290

Certain possible events must contradict the law if it is to be one at all; and should these occur, they must be explained by a different law.

Page 290

When we wager on a possibility, it's always on the assumption of the uniformity of nature.

Page 290

If we say the molecules of a gas move in accordance with the laws of probability, it creates the impression that they move in accordance with some *a priori* laws or other. Naturally, that's nonsense. The laws of probability, i.e. those on which the calculation is *based*,

Page Break 291

are hypothetical assumptions, which are then rehashed by the calculation and then in another form empirically confirmed--or refuted.

Page 291

If you look at what is called the *a priori* probability and then at its confirmation by the relative frequency of events, the chief thing that strikes you is that the *a priori* probability, which is, as it were, something smooth, is supposed to govern the relative frequency, which is something irregular. If both bundles of hay are the same size and the same distance away, that would explain why the donkey stands still between them, but it's no explanation of its eating roughly as often from the one as from the other. *That* requires *different* laws of nature to explain it.--The facts that the die is homogeneous and that each side is exactly the same, and that the natural laws with which I'm familiar tell me nothing about the result of a throw, don't give me adequate grounds for inferring that the numbers 1 to 6 will be distributed roughly equally among the numbers thrown. Rather, the prediction that such a distribution will be the case contains an assumption about those natural laws that I don't know precisely: the assumption that *they* will produce such a distribution.

Page 291

234 Isn't the following fact inconsistent with my conception of probability: it's obviously conceivable that a man throwing dice every day for a week--let's say--throws nothing but ones, and not because of any defect in the die, but simply because the movement of his hand, the position of the die in the box, the friction of the table top always conspire to produce the same result. The man has inspected the die, and also found that when others throw it the normal results are produced. Has he grounds, now, for thinking that there's a natural law at work here which makes him throw nothing but ones? Has he grounds for believing that it's sure now to go on like this, or has he grounds for believing that this regularity can't last much longer? That is, has he grounds for abandoning the game since it has become clear that he can only

Page Break 292

throw ones, or for playing on since it is in these circumstances all the more probable that he will now throw a higher number? In actual fact, he will refuse to accept it as a natural law that he can throw nothing but ones. At least, it will have to go on for a long time before he will entertain this possibility. But why? I believe, because so much of his previous experience in life speaks against there being a law of nature of such a sort, and we have--so to speak--to surmount all that experience, before embracing a totally new way of looking at things.

Page 292

If we infer from the relative frequency of an event its relative frequency in the future, we can of course only do that from the frequency which has in fact been so far observed. And not from one we have derived from observation by some process or other for calculating probabilities. For the probability we calculate is compatible with *any* frequency whatever that we actually observe, since it leaves the time open.

Page 292

When a gambler or insurance company is guided by probability, they aren't guided by the probability calculus, since one can't be guided by this on its own, because *anything* that happens can be reconciled with it: no, the insurance company is guided by a frequency actually observed. And that, of course, is an absolute frequency.

Page 292

235 We can represent the equation of this curve:

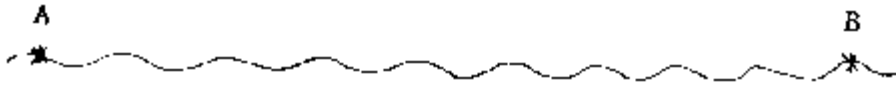

as the equation of a straight line with a variable parameter, whose course expresses the deviations from a straight line. It isn't essential that these deviations should be 'slight'. They can be so large that the curve doesn't look like a straight line at all. 'Straight line with deviations' is *only one form* of description. It makes it possible for me to neglect a particular component of the description--if I so wish. (The form: 'rule with exceptions'.)

Page Break 293

Page 293

A Galtonian photograph is the picture of a probability [\dagger 1].

Page 293

A probability law is the natural law you see when you screw up your eyes.

Page 293

To say that the points yielded by this experiment distribute themselves around this curve--e.g. a straight line--means something like: seen from a certain distance, they appear to lie on a straight line.

Page 293

If I state 'That's the rule', that only has a sense as long as I have determined the maximum number of exceptions I'll allow before knocking down the rule.

Page 293

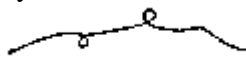
236 I can say of a curve  that the general impression is one of a straight line, but not of the curve  even though it might be possible to see this stretch in the course of a long stretch of curve in which its divergence from a straight line would be swallowed up.

Page 293

I mean: it only makes sense to say of the stretch you actually see (and not of an hypothetical one you assume) that it gives the general impression of a straight line.

Page 293

What is meant in a statistical experiment by 'in the long run'? An experiment must have a beginning and an end.

Page 293

An experiment with dice lasts a certain time, and our expectations for the future can only be based on tendencies we observe in what happens during this experiment. That is to say, the experiment can only give grounds for expecting that things will go on *in the way* shown by the experiment; but we can't expect that the experiment,

Page Break 294

if continued, will now yield results that tally better with a preconceived idea of its course than did those of the experiment we have actually performed.

Page 294

So if, for instance, I toss a coin and find no tendency in the results of the experiment itself for the numbers of heads and of tails to approximate to each other more closely, then the experiment gives me no reason to suppose that if it were continued such an approximation would emerge. Indeed, the expectation of such an approximation must *itself* refer to a definite point in time, since I can't expect something to happen *eventually*, without setting any finite limit whatever to the time when.

Page 294

I can't say: 'The curve  looks straight, since it could be part of a line which taken as a whole gives me the impression of a straight line.'

Page 294

237 Any 'reasonable' expectation is an expectation that a rule we have observed up to now will continue to hold.

Page 294

But the rule must have been observed and can't, for its part too, be merely expected.

Page 294

Probability Theory is only concerned with the state of expectation in the sense in which logic is with

thinking.

Page 294

Rather, probability is concerned with the form and a standard of expectation.

Page 294

It's a question of expecting that future experience will obey a law which has been obeyed by previous experience.

Page 294

'It's likely that an event will occur' means: *something speaks in favour* of its occurring.

Page Break 295

238

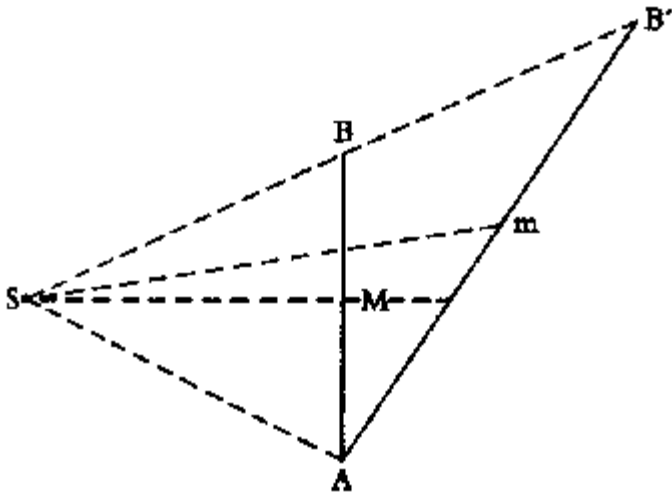

Page 295

A ray is emitted from the light source S striking the surface AB to form a point of light there, and then striking the surface AB' to form one there. We have no reason to suppose that the point on AB lies to the left or to the right of M, and equally none for supposing that the point on AB' lies to the right or to the left of m; this yields apparently incompatible probabilities.

Page 295

But suppose I have made an assumption about the probability of the point on AB lying in AM, how is this assumption verified? Surely by a frequency experiment. Supposing this confirms the one view, then that is recognized as the right one and so shows itself to be an hypothesis belonging to *physics*. The geometrical construction merely shows that the fact that $AM = MB$ was *no* ground for assuming equal likelihood.

Page 295

I give someone the following piece of information, and no more: at such and such a time you will see a point of light appear in the interval AB.

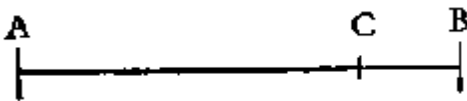

Page 295

Does the question now make sense, 'Is it more likely that this point will appear in the interval AC than in CB?'' I believe,

Page Break 296

obviously not.--I can of course decide that the probability of the event's happening in CB is to be in the ratio CB/AC to the probability of its happening in AC; however, that's a decision I can have empirical grounds for making, but about which there is nothing to be said *a priori*. It is possible for the observed distribution of events not to lead to this assumption [†1]. The probability, where infinitely many possibilities come into consideration, must of course be treated as a limit. That is, if I divide the stretch AB into arbitrarily many parts of arbitrary lengths and regard it as equally likely that the event should occur in any one of these parts, we immediately have the simple case of dice before us. And now I can--arbitrarily--lay down a law for constructing parts of equal likelihood. For instance, the law that, if the lengths of the parts are equal, they are equally likely. But any other law is just as permissible.

Page 296

Couldn't I, in the case of dice too, take, say, five faces together as one possibility, and oppose them to the

sixth as the second possibility? And what, apart from experience, is there to prevent me from regarding these two possibilities as equally likely?

Page 296

Let's imagine throwing, say, a red ball with just one very small green patch on it. Isn't it much more likely in this case for the red area to strike the ground than for the green?--But how would we support this proposition? Presumably by showing that when we throw the ball, the red strikes the ground much more often than the green. But that's got nothing to do with logic.--We may always project the red and green surfaces and what befalls them onto a surface in such a way that the projection of the green surface is greater than or equal to the red; so that the events, as seen in this projection, appear to have a quite different probability ratio from the one they had on the original surface.

Page 296

If, e.g., I reflect the events in a suitably curved mirror and now imagine what I would have held to be the more probable event if I had only seen the image in the mirror.

Page 296

The one thing the mirror can't alter is the number of clearly

Page Break 297

demarcated possibilities. So that if I have n coloured patches on my ball, the mirror will also show n , and if I have decided that these are to be regarded as equally likely, then I can stick to this decision for the mirror image too.

Page 297

To make myself even clearer: if I carry out the experiment with a concave mirror, i.e., make the *observations* in a concave mirror, it will perhaps then look as if the ball falls more often on the small surface than on the much larger one; and it's clear that neither experiment--in the mirror or outside it has a claim to precedence.

Page 297

What now, does it really mean to decide that two possibilities are equally likely?

Page 297

Doesn't it mean that, first, the natural laws known to us give no preference to either of the possibilities, and second, that under certain conditions the relative frequencies of the two events approach one another?

Page Break 298

Page Break 299

APPENDIX I

Page 299

Written in 1931

Page Break 300

Page Break 301

Complex and Fact (June 1931)

Page 301

The use of the words 'fact' and 'act'.--'That was a noble act.'--'But, that never happened.'--

Page 301

It is natural to want to use the word 'act' so that it only corresponds to a *true* proposition. So that we then don't talk of an act which was never performed. But the proposition 'That was a noble act' must still have a sense even if I am mistaken in thinking that what I call an act occurred. And that of itself contains all that matters, and I can only make the stipulation that I will only use the words 'fact', 'act' (perhaps also 'event') in a proposition which, when complete, asserts that this fact obtains.

Page 301

It would be better to drop the restriction on the use of these words, since it only leads to confusion, and say quite happily: 'This act was never performed', 'This fact does not obtain', 'This event did not occur'.

Page 301

Complex is not like fact. For I can, e.g., say of a complex that it moves from one place to another, but not of a fact.

Page 301

But that this complex is now situated here is a fact.

Page 301

'This complex of buildings is coming down' is tantamount to: 'The buildings thus grouped together are coming down'.

Page 301

I call a flower, a house, a constellation, complexes: moreover, complexes of petals, bricks, stars, etc.

Page 301

That this constellation is located here, can of course be described by a proposition in which only its stars are mentioned and neither the word 'constellation' nor its name occurs.

Page 301

But that is all there is to say about the relation between complex and fact. And a complex is a spatial object, composed of spatial

Page Break 302

objects. (The concept 'spatial' admitting of a certain extension.)

Page 302

A complex is composed of its parts, the things of a kind which go to make it up. (This is of course a grammatical proposition concerning the words 'complex', 'part' and 'compose'.)

Page 302

To say that a red circle is *composed* of redness and circularity, or is a complex with these component parts, is a misuse of these words and is misleading. (Frege was aware of this and told me.)

Page 302

It is just as misleading to say the fact that this circle is red (that I am tired) is a complex whose component parts are a circle and redness (myself and tiredness).

Page 302

Neither is a house a complex of bricks and their spatial relations; i.e. that too goes against the correct use of the word.

Page 302

Now, you can of course point at a constellation and say: this constellation is composed entirely of objects with which I am already acquainted; but you can't 'point at a fact' and say this.

Page 302

'To describe a fact', or 'the description of a fact', is also a misleading expression for the assertion stating that the fact obtains, since it sounds like: 'describing the animal that I saw'.

Page 302

Of course we also say: 'to point out a fact', but that always means; 'to point out the fact that...'. Whereas 'to point at (or point out) a flower' doesn't mean to point out that this blossom is on this stalk; for we needn't be talking about this blossom and this stalk at all.

Page 302

It's just as impossible for it to mean: to point out the fact that this flower is situated there.

Page Break 303

Page 303

To point out a fact means to assert something, to state something. 'To point out a flower' doesn't mean this.

Page 303

A chain, too, is composed of its links, not of these and their spatial relations.

Page 303

The fact that these links are so concatenated, isn't '*composed*' of anything at all.

Page 303

The root of this muddle is the confusing use of the word 'object'.

Page 303

The part is smaller than the whole: applied to fact and component part (constituent), that would yield an absurdity.†*

Page Break 304

If you speak of the concept 'infinity', you must remember that this word has many different meanings and bear in mind which one we are going to speak of at this particular moment. Whether, e.g., of the infinity of a number series and of the cardinals in particular. If, for example, I say 'infinite' is a characteristic of a rule, I am referring to *one* particular meaning of the word. But we might perfectly well say a continuous transition of colour was a transition 'through infinitely many stages', provided we don't forget that here we are defining the meaning of the phrase 'infinitely many stages' *anew* by means of the experience of a colour transition. (Even if by analogy with other ways of using the word 'infinite'.)

(If we say that this area of our subject is extraordinarily difficult, that isn't true in the sense that we are, say, talking about things which are extraordinarily complicated or difficult to imagine, but only in the sense that it is extraordinarily difficult to negotiate the countless pitfalls language puts in our path here.)

I once said there was no extensional infinity. Ramsey replied: "Can't we imagine a man living for ever, that is simply, never dying, and isn't that extensional infinity?" I can surely imagine a wheel spinning and *never* coming to rest' [†1]. What a peculiar

argument: 'I can imagine...!' Let's consider what experience we would regard as a confirmation or proof of the fact that the wheel will never stop spinning. And compare this experience with that which would tell us that the wheel spins for a day, for a year, for ten years, and we shall find it easy to see the difference in the grammar of the assertions '... never comes to rest' and '... comes to rest in 100 years'. Let's think of the kind of evidence we might adduce for the claim that two heavenly bodies will orbit around one another, without end. Or of the Law of Inertia and how it is confirmed.

'Suppose we travel out along a straight line into Euclidean space and that at 10m. intervals we encounter an iron sphere, *ad. inf.*' [†1]. Again: What sort of experience would I regard as confirmation for this, and what on the other hand for there being 10,000 spheres in a row?--A confirmation of the first sort would be something like the following: I observe the pendulum movement of a body. Experiments have shown me that this body is attracted by iron spheres in accordance with a certain law; supposing there to be 100 such spheres in a series at a particular position with respect to the body under test would explain, on the assumption of this law of attraction, an approximation to the observed (or supposed) behaviour; but the more spheres we suppose there to be in the series, the more closely does the result calculated agree with the one observed. In that case, it makes sense to say experience confirms the supposition of an infinite series of spheres. But the difference between the sense of the statement of number and that of 'an infinite number' is as great as the difference between this experience and that of seeing a number of spheres.

'The merely negative description of not stopping cannot yield a positive infinity' [†2]. With the phrase 'a positive infinity' I

thought of course of a countable (= finite) set of things (chairs in this room) and wanted to say that the presence of a colossal number of such things can't be inferred from whatever it is that indicates to us that they don't stop. And so here in the form of my assertion I make the strange mistake of denying a fact, instead of denying that a particular proposition makes sense, or more strictly, of showing that two similar sounding remarks have different grammars.

What an odd question: 'Can we imagine an endless row of trees?!' If we speak of an 'endless row of trees', we will surely still link what we mean with the experiences we call 'seeing a row of trees', 'counting a row of trees', 'measuring a row of trees' etc. 'Can we imagine an endless row of trees?!' Certainly, once we have laid down what we are to understand by this; that is once we have brought this concept into relation with all these things, with the experiences which define for us the concept of a row of trees.

What in experience is the criterion for the row of trees being infinite? For that will show me how this assertion is to be understood. Or, if you give me no such criterion, what am I then supposed to do with the concept 'infinite row of trees'? What on earth has this concept to do with what I ordinarily call a row of trees? Or didn't you in the end only mean: an enormously long row of trees?

Page 306

'But we are surely familiar with an experience, when we walk along a row of trees, which we can call the row coming to an end. Well, an endless row of trees is one such that we never have this experience.'--But what does 'never' mean here? I am familiar with an experience I describe by the words 'He never coughed during the whole hour', or 'He never laughed in his whole life'. We cannot speak of an analogous experience where the 'never' doesn't refer to a time interval. And so once again analogy leaves us in the lurch here and I must try to find out *ab initio* how the word

Page Break 307

'never' can be used so as to make sense in this case.--Admittedly such uses can be found, but their rules are to be examined in their own right. For example, the proposition that a row of trees is infinitely long (or that we shall *never* come to its end), could be a natural law of the same sort as the Law of Inertia, which certainly says that under certain conditions a body moves in a straight line with constant velocity; and here it could indeed be said that under those conditions the movement will *never* end. But if we ask about the verification of such a proposition, the main thing to be said is that it is falsified if the movement (row of trees) comes to an end. There can be no talk of a verification here, and that means we are dealing with a fundamentally different kind of proposition (or with a proposition, in a different sense of that word). Naturally I don't want to say that this is the only significant use of the expression 'infinite row of trees' or of the word 'never' (in all eternity). But each such use must be described in its own right and has its own laws. It's no help to us that we find a way of speaking ready-made in our ordinary language, since this language uses each of its words with the most varied meanings, and understanding the use of the word in *one* context does not relieve us from investigating its grammar in another. Thus we think something like 'It is still surely possible to imagine an infinitely long life, for a man lives for an infinite length of time, if he simply never dies.' But the use of the word 'never' just isn't that simple.

Page 307

Let's now discuss an endless life in the sense of an hypothesis (cf. the Law of Inertia), and the man living it choosing in succession an arbitrary fraction from the fractions between 1 and 2, 2 and 3, 3 and 4, etc. *ad inf.* and writing it down. Does this give us a 'selection from all those intervals'? No,... /see above, §146, p. 167.

Page 307

'But now let's imagine a man who becomes more and more adept at choosing from intervals, so that he would take an hour for the first choice, half an hour for the second, a quarter for the third, etc. *ad inf.* In that case he would have done the whole job

Page Break 308

in two hours!' [†1] Let's now imagine the process. The choice would consist, say, in his writing down a fraction, and so in moving his hand. This movement would get quicker and quicker; but however quick it becomes, there will always be a last interval that has been dealt with in a particular time. The consideration behind our objection depends on forming the sum $1 + \frac{1}{2} + \frac{1}{4} + \dots$, but that is of course a *limit* of a series of sums, and not a sum in the sense in which, e.g., $1 + \frac{1}{2} + \frac{1}{4}$ is a sum. If I were to say 'He needs an hour for the first choice, half an hour for the second, a quarter for the third, etc. *ad. inf.*' then this remark only makes sense so long as I *don't* ask about the velocity of the choice at the time instant $t = 2$, since our reckoning gives no value for this (for there's no value $c = \text{infinity}$ here as far as we're concerned, since we haven't correlated any experience with it). My law gives me a velocity for any instant *before* $t = 2$, and so is to that extent applicable and in order. Thus the fallacy lies only in the sentence 'In that case he would have done the whole job in two hours'. (If we can call that a fallacy, since the sentence is in fact senseless in this context.)

Page 308

Let's now consider the hypothesis that under certain conditions someone will throw the digits of π (say, expressed in a system to the base 6). This hypothesis is, then, a law according to which I can work out for any throw the number of spots showing. But what if we modified the hypothesis into one that under certain conditions someone would *not* throw the digits of π ! Shouldn't that make sense too? But how could we ever know that this hypothesis was correct, since up to any given time he may have thrown in agreement with π , and yet this would not refute the hypothesis. But that surely just means that we have to do with a different *kind* of hypothesis; with a kind of proposition for which no *provision* is made in its grammar for a falsification. And it is open

to me to call that a 'proposition' or 'hypothesis' or something quite different, as I like. (π is not a decimal fraction, but a *law* according to which decimal fractions are formed.)

The infinity of time is not a duration.

If we ask 'What constitutes the infinity of time?' the reply will be 'That no day is the last, that each day is followed by another'. But here we are misled again into seeing the situation in the light of a false analogy. For we are comparing the succession of days with the succession of events, such as the strokes of a clock. In such a case we sometimes experience a fifth stroke following four strokes. Now, does it also make sense to talk of the experience of a fifth day following four days? And could someone say 'See, I told you so: I said there would be another after the fourth'? (You might just as well say it's an experience that the fourth is followed by the fifth and no other.) But we aren't talking here about the prediction that the sun will continue to move after the fourth day as before, *that's* a genuine prediction. No, in our case it's not a question of a prediction, no event is prophesied; what we're saying is something like this: that it makes sense, in respect of any sunrise or sunset, to talk of a next. For what is meant by designation of a period of time is of course bound up with something happening: the movement of the hand of a clock, of the earth, etc., etc.; but when we say 'each hour is succeeded by a next', having defined an hour by means of the revolution of a particular pointer (as a paradigm), we are still not using that assertion in order to prophesy that this pointer will go on in the same way for all eternity:--but we want to say: that it *can* go on in the same way for ever'; and that is simply an assertion concerning the grammar of our determinations of time.

Let's compare the propositions 'I'm making my plans on the assumption that this situation will last for two years' and 'I'm

making them on the assumption that this situation will last for ever'.--Does the proposition make sense 'I believe (or expect, or hope), that it will stay like that throughout infinite time'?

We may say: 'I am making arrangements for the next three days', or 10 years, etc., and also 'I'm making arrangements for an indefinite period';--but also 'for an infinite time'? If I 'make arrangements for an indefinite period', it is surely possible to mention a time for which at any rate I am no longer making arrangements. That is, the proposition 'I am making arrangements for an indefinite period' does not imply every arbitrary proposition of the form 'I am making arrangements for n years'.

Just think of the proposition: 'I *suspect* this situation will continue like this without end'!

Or how comical this rebuttal sounds: 'You said this clockwork would run for ever--well, it's already stopped *now*'. We feel that surely every finite prediction of too long a run would also be refuted by the fact, and so in some sense or other the refutation is incommensurable with the claim.--For it is nonsense to say 'The clockwork didn't go on running for an infinite time, but stopped after 10 years' (or, even more comically: '... but stopped after only 10 years').

How odd, if someone were to say: 'You have to be very bold to predict something for 100 years;--but how bold you must be to predict something for infinite time, as Newton did with his Law of Inertia!'

'I believe it will go on like that for ever'.--Isn't it enough (for all practical purposes) to say you believe it will go on like that for 10,000 years?--That is to say, we must ask: Can there be grounds for this belief? What are they? What are the grounds for assuming that it will go on for 1,000 more years; what for assuming it will go on for 10,000 more years;--and, now, what are the grounds for the infinite assumption?!--That's what makes the sentence 'I suspect it will go on without end' so comic; we want to ask, why do you suspect that? For we want to say it's senseless to say you suspect that: because it's senseless to talk of grounds for such a suspicion.

Let's consider the proposition 'This comet will move in a parabola with equation...'. How is this proposition used? It cannot be verified; that is to say: *we* have made no provision for a verification in its grammar (that doesn't of

course mean we can't say it's true; for ' p is true' says the same as ' p '). The proposition can bring us to make certain observations. But for those a finite prediction would always have done equally well. It will also determine certain actions. For instance, it might dissuade us from looking for the comet in such and such a place. But for that too, a finite claim would have been enough. The infinity of the hypothesis doesn't consist of its *largeness*, but in its open-endedness.

Page 311

'Eventually, the world will come to an end': an infinite hypothesis.

Page 311

The proposition that eventually--in the infinite future--an event (e.g. the end of the world) will occur, has a certain formal similarity with what we call a tautology.

Infinite Possibility

Page 311

Different use of the word 'can' in the propositions 'Three objects can lie in this direction' and 'Infinitely many objects can lie in this direction' [†1]. What sense, that is to say, what grammar could such a way of talking possess? We might for example say: 'In the natural number series 1, 2, 3, 4.... infinitely many numerals can follow the "1"'; that is tantamount to: 'The operation $+ 1$ may be applied ever again (or: without end)'. And so if, for example, someone writes the numeral $100 + 1$ after the numeral 100, that rule gives him the right to do so. On the other hand, there is no

Page Break 312

sense here in saying: 'If it's permissible to write down infinitely many numerals, let's write infinitely many numerals (or try to)!'--

Page 312

Analogously, if I say a division yields an infinite decimal fraction, then there isn't *one* result of the division called 'an infinite decimal', in the sense in which the number 0.142 is a result of $1 \div 7$. The division doesn't yield as its final result *one* decimal number, or a number of decimal numbers but rather we can't talk of 'its final result': it endlessly yields decimal fractions; not 'an endless decimal fraction'. 'Endlessly' not 'endless'.

Page 312

Let's now imagine the following case: I have constructed a particular kind of die, and am now going to predict: 'I shall throw the places of π with this die'. This claim is of a different form from the apparently similar 'I shall throw the first ten places of π with this die'. For in the second case there is a proposition 'I shall have thrown the first ten places of π within the hour', but this proposition becomes nonsense (not false), if I substitute 'the places' for 'the first ten places'. In the sentence 'Any arbitrary number of throws is possible', 'possible' may be equivalent to 'logically possible' ('conceivable'), and then it is a rule, not an empirical proposition, and is of a similar sort to that of the rule 'numerals can follow 1 without end'. But we might also construe it as a kind of empirical proposition, a kind of hypothesis: but then it would be the kind of hypothesis which has no verification provided for it, only a falsification, and so it would be a different kind of proposition (a 'proposition' in a different sense) from the empirical proposition: 'Three throws are possible with this die'. This--unlike the *rule* 'Three throws are conceivable'--would mean something like: 'The die will still be usable after three throws'; the hypothesis 'Infinitely many throws are possible with this die' would mean 'However often you throw it, this die will not wear out'. It's very clear that these propositions are different in kind, if you think of the nonsensical order 'Throw it infinitely often' or 'Throw *ad infinitum*', as opposed to the significant 'Throw it three times'. For it is essential to a command that we can check whether it has been carried out.

Page Break 313

Page 313

If we wish to say infinity is an attribute of possibility, not of reality, or: the word 'infinite' always goes with the word 'possible', and the like,--then this amounts to saying: the word 'infinite' is always a part of a *rule*.

Page 313

Let's suppose we told someone: 'I bought a ruler yesterday with infinite curvature'. Here, however, the word 'infinite' surely occurs in the description of a reality.--But still, I can never have the experience which would justify me in saying that the ruler actually had an infinite radius of curvature, since a radius of 100^{100} km would surely do just as well.--Granted, but in that case I can't have the experience which would justify me in saying the ruler is *straight* either. And the words 'straight' (or in another context 'parallel') and 'infinite' are in the *same* boat. I mean: If the word 'straight', ('parallel', 'equally long', etc., etc.) may occur in a description of reality, then so may the word 'infinite' [†1].

'All that's infinite is the possibility' means "'infinite" qualifies "etc.".' And so far as this is what it does, it belongs in a rule, a law. It's out of place in describing experience only when we mean by 'experience that corresponds to a law' an endless series of experiences.--The slogan 'all that's infinite is the possibility, not the reality' is misleading. We may say: '*In this case* all that's infinite is the possibility'.--And we justifiably ask: what is it that is infinite about this hypothesis (e.g. about the path of a comet)? Is there something huge about this assumption, this thought?

If we say 'The possibility of forming decimal places in the division $1 \div 3$ is infinite', we don't pin down a fact of nature, but give a rule of the system of calculation. But if I say: 'I give you infinite freedom to develop as many places as you like, I won't stop you', then this isn't enunciating the rule of the system of calculation, it's saying something about the future. 'Yes, but still only as the description of a possibility'.--No, of a reality! But *of*

course not that of 'infinitely many places'; to say that would be to fall into the very grammatical trap we must avoid.

The fact that it permits the endless formation of numerals doesn't make grammar infinitely complicated.

To explain the infinite possibility, it must be sufficient to point out the features of the sign which lead us to assume this infinite possibility, or better: from which we read off this infinite possibility. That is, what is actually present in the sign must be sufficient, and the possibilities of the sign, which once more could only emerge from a description of signs, do not come into the discussion [†1]. And so everything must be already contained in the sign '/1, x, x + 1/'--the expression for the rule of formation. In introducing infinite possibility, I mustn't reintroduce a mythical element into grammar. If we describe the process of division $1.0 \div 3 = 0.3$, which leads to the quotient 0.3 and remainder 1, the infinite possibility of going on with always the same result must be contained in this description, since we certainly aren't given anything else, when we see 'that it must always go on in the same way'.

And when we 'see the infinite possibility of going on', we still can't see anything that isn't described when we simply describe the sign we see.

APPENDIX 2

From F. Waismann's shorthand transcript of Wittgenstein's talks and conversation between December 1929 and September 1931.

Yardstick and System of Propositions

(From F. Waismann's notes for 25 December 1929.)

I once wrote: 'A proposition is laid like a yardstick against reality. Only the outermost tips of the graduation marks touch the object to be measured.' I should now prefer to say: a *system of propositions* is laid like a yardstick against reality. What I mean by this is: when I lay a yardstick against a spatial object, I apply *all the graduation marks simultaneously*. It's not the individual graduation marks that are applied, it's the whole scale. If I know that the object reaches up to the tenth graduation mark, I also know immediately that it doesn't reach the eleventh, twelfth, etc. The assertions telling me the length of an object form a system, a system of propositions. It's such a whole system which is compared with reality, not a single proposition. If, for instance, I say such and such a point in the visual field is *blue*, I not only know that, I also know that the point isn't green, isn't red, isn't yellow etc. I have simultaneously applied the whole colour scale. This is also the reason why a point can't have different colours simultaneously; why there is a syntactical rule against *fx* being true for more than one value of *x*. For if I apply a

system of propositions to reality, that of itself already implies--as in the spatial case--that in every case only *one* state of affairs can obtain, never several.

Page 317

When I was working on my book I was still unaware of all this and thought then that every inference depended on the form of a tautology. I hadn't seen then that an inference can also be of the form: A man is 6 ft tall, therefore he isn't 7 ft. This is bound up with my then believing that elementary propositions had to be independent of one another: from the fact that one state of affairs obtained you couldn't infer another did not. But if my present conception of a system of propositions is right, then it's even the rule that from the fact that one state of affairs obtains we can infer that all the others described by the system of propositions do not.

Page Break 318

Consistency

Page 318

(Waismann's notes, Wednesday, 17 December, 1930, Neuwaldegg. Transcript of Wittgenstein's words, unless otherwise indicated.)

Page 318

I've been reading a work by Hilbert on consistency. It strikes me that this whole question has been put wrongly. I should like to ask: *Can* mathematics be inconsistent at all? I should like to ask these people: Look, what are you really up to? Do you really believe there are contradictions hidden in mathematics?

Page 318

Axioms have a twofold significance, as Frege saw.

Page 318

1) The rules, *according to* which you play.

Page 318

2) The opening positions of the game.

Page 318

If you take the axioms in the second way, I can attach no sense to the claim that they are inconsistent. It would be very queer to say: this configuration (e.g. in the Hilbertian formula game, $0 \neq 0$) is a contradiction. And if I do call some configuration or other a contradiction, that has no essential significance, at least for the game *qua* game. If I arrange the rules so that this configuration can't arise, all I've done is made up a different game. But the game's a game, and I can't begin to understand why anyone should attach such great importance to the occurrence of this configuration: they behave as though this particular one were tabu. I then ask: and what is there to get excited about if this configuration does arise?

Page 318

The situation is completely different if the axioms are taken as the rules *according to* which the game is played. The rules are--in a certain sense--statements. They say: you may do this or this, but not that. Two rules can be inconsistent. Suppose, e.g., that in chess one rule ran: under such and such circumstances the piece concerned must be taken. But another rule said: a knight may never be taken. If now the piece concerned happens to be a knight, the

Page Break 319

rules contradict one another: I don't know what I'm supposed to do. What do we do in such a case? Nothing easier: we introduce a new rule, and the conflict is resolved.

Page 319

My point, then, is: if inconsistencies were to arise between the rules of the game of mathematics, it would be the easiest thing in the world to remedy. All we have to do is to make a new stipulation to cover the case in which the rules conflict, and the matter's resolved.

Page 319

But here I must make an important point. A contradiction is only a contradiction *when it arises*. People have the idea that there might at the outset be a contradiction hidden away in the axioms which no-one has seen, like tuberculosis: a man doesn't suspect anything and then one day he's dead. That's how people think of this case too: one day the hidden contradiction might break out, and then the catastrophe would be upon us.

Page 319

What I'm saying is: to ask whether the derivations might not eventually lead to a contradiction makes no sense at all as long as I'm given no method for discovering it.

Page 319

While I can play, I can play, and everything's all right.

The truth of the matter is that the calculus *qua* calculus is all right. It doesn't make any sense whatever to talk about contradiction. What we call a contradiction arises when we step outside the calculus and say in prose: 'Therefore all numbers have this property, but the number 17 doesn't have it.'

In the calculus the contradiction can't be expressed at all.

I can play with the chessmen according to certain rules. But I can also invent a game in which I play with the rules themselves. The pieces in my game are now the rules of chess, and the rules of the game are, say, the laws of logic. *In that case I have yet another game and not a metagame.* What Hilbert does is mathematics and not metamathematics. It's another calculus, just like any other.

(Sunday, 28 December 1930, at Schlick's home.)

The problem of the consistency of mathematics stems from two

sources: (1) From the idea of non-Euclidean geometry where it was a matter of proving the axiom of parallels by means of the given paradigm of a *reductio ad absurdum*. (2) From the Burali-Forti and Russellian antinomies.

The impetus behind the present preoccupation with consistency came mainly from the antinomies. Now, it has to be said that these antinomies haven't got anything to do with consistency in mathematics, that there's no connection here at all. For the antinomies didn't in fact arise in the calculus, but in ordinary everyday speech, precisely because we use words ambiguously. So that resolving the antinomies consists in replacing the vague idiom by a precise one (by reflecting on the strict meaning of the words). And so the antinomies *vanish* by means of an *analysis*, not of a *proof*.

If the contradictions in mathematics arise through an unclarity, I can *never dispel this unclarity by a proof*. The proof only proves what it proves. But it can't lift the fog.

This of itself shows that there can be no such thing as a consistency proof (if we are thinking of the inconsistencies of mathematics as being of the same sort as the inconsistencies of set theory), that the proof can't begin to offer what we want of it. If I'm unclear about the nature of mathematics, no proof can help me. And if I'm clear about the nature of mathematics, the question of consistency can't arise at all.

Russell had the idea that his 5 'primitive propositions' were to be both the basic configurations and the rules for going on. But he was under an illusion here, and this came out in the fact that he himself had to add further rules (in words!).

So we must distinguish: the basic configurations of the calculus (the opening positions of the game) and the rules telling us how to get from one configuration to another. This was already made clear by Frege in his critique of the theories of Heine and Thomae: 'How surprising. What would someone say if he asked what the rules of chess were and instead of an answer was shown a group of chessmen on the chessboard? Presumably that he couldn't find

a rule in this, since he didn't attach any sense at all to these pieces and their layout' (*Grundgesetze*, II, p. 113).

Now if I take the calculus as a calculus, the positions in the game can't represent contradictions (unless I arbitrarily call one of the positions that arise in the game a 'contradiction' and exclude it; all I'm doing in that case is declaring that I'm playing a *different* game).

The idea of inconsistency --this is what I'm insisting on--is contradiction [\dagger 1], and this can only *arise in the true/false* game, i.e. only where we are making assertions.

That is to say: A contradiction can only occur among the *rules of the game*. I can for instance have one rule saying the white piece must jump over the black one.

Now if the black is at the edge of the board, the rule breaks down. So the situation can arise where I don't

know what I'm meant to do. The rule doesn't tell me anything any more. What would I do in such a case? There's nothing simpler than removing the inconsistency: I must make a decision, i.e. introduce another rule.

Page 321

By permission and prohibition, I can always only define a game, never *the game*. What Hilbert is trying to show by his proof is that the axioms of arithmetic have the properties of *the game*, and that's impossible. It's as if Hilbert would like to prove that a contradiction is inadmissible.

Page 321

Incidentally, suppose two of the rules were to contradict one another. I have such a bad memory that I never notice this, but always forget one of the two rules or alternately follow one and then the other. Even in this case I would say everything's in order.

Page Break 322

The rules are instructions how to play, and as long as I can play they must be all right. They only cease to be all right the moment I *notice* that they are inconsistent, and the only sign for that is that I can't apply them any more. For the logical product of the two rules is a contradiction, and the contradiction no longer tells me what to do. And so the conflict only arises when I notice it. While I could play there was no problem.

Page 322

In arithmetic, too, we arrive at 'the edge of the chessboard', e.g. with the problem $\%$. (Were I to say $\% = 1$, I could prove $3 = 5$ and thus would come into conflict with the other rules of the game.)

Page 322

We see then that as long as we take the calculus as a calculus the question of consistency cannot arise as a serious question at all. And so is consistency perhaps connected with the *application* of the calculus? With this in mind, we must ask ourselves:

Page 322

What does it mean, to apply a calculus?

Page 322

It can mean two different things.

Page 322

1) We apply the calculus in such a way as to provide the grammar of a language. For, what is permitted or forbidden by the rules then corresponds in the grammar to the words 'sense' and 'senseless'. For example: Euclidean geometry construed as a system of syntactical rules according to which we describe spatial objects. 'Through any 2 points, a straight line can be drawn' means: a claim mentioning the line determined by these 2 points makes sense whether it happens to be true or false.

Page 322

A rule of syntax corresponds to the position in the game. (Can the rules of syntax contradict one another?) Syntax cannot be justified.

Page 322

2) A calculus can be applied so that *true* and *false* propositions correspond to the configurations of the calculus. Then the calculus yields a theory, describing something.

Page 322

Newton's three laws have a completely different significance from those of geometry. There is a verification for them--by experiments in physics. But there is no such thing as a justification for a game. That is highly important. You can construe geometry in this way too, by taking it as the description of actual measurements. Now we have claims before us, and claims can indeed be inconsistent.

Page Break 323

Page 323

Whether the theory *can* describe something depends on whether the logical product of the axioms is a contradiction. Either I see straight off that they form a contradiction, in which case the situation's clear; or I don't what then? Then there's a *hidden* contradiction present. For instance: Euclid's axioms together with the axiom 'The sum of the angles of a triangle is 181° '. Here I can't see the contradiction straight off, since I can't see straight off that a sum of 180° follows from the axioms.

Page 323

As long as we stay within the calculus, we don't have any contradiction. For $s = 180^\circ$, $s = 181^\circ$ don't contradict one another at all. We can simply make two different stipulations. All we can say is: the calculus is applicable to everything to which it is applicable. Indeed, even here an application might still be conceivable, e.g. in

such a way that, measured by one method, the sum of the angles of a triangle comes to 180° , and by another to 181° . It's only a matter of finding a domain whose description requires the multiplicity possessed by the axioms.

Page 323

Now if a contradiction occurs at this point in a *theory*, that would mean that the propositions of the theory couldn't be translated into statements about how a galvanometer needle is deflected, etc., any more. It might for instance come out that the needle stays still or is deflected, and so this theory couldn't be verified.

Page 323

Unlike geometrical equations, Maxwell's equations don't represent a calculus, they are a fragment, a part of a calculus.

Page 323

What does it mean, mathematics must be 'made secure' [\dagger 1]? What would happen if mathematics weren't secure? For is it any kind of claim at all, to say that the axioms are consistent?

Page 323

Can one look for a contradiction? Only if there is a method for looking. There can be no such question as whether we will ever come upon a contradiction by going on in accordance with the rules. I believe that's the crucial point, on which everything

Page Break 324

depends in the question of consistency.

Page 324

WAISMANN ASKS: But doesn't it make sense to ask oneself questions about an axiom system? Let's consider, for instance, the propositional calculus which Russell derives from 5 axioms. Bernays has shown one of these axioms is redundant, and that just 4 will do. He has gone on to show that these axioms form a 'complete system', i.e. that adding another axiom which can't be derived from these 4 makes it possible to derive any proposition you write down whatever. *This* comes down to the same thing as saying that every proposition follows from a contradiction. Now, isn't that a *material insight* into the Russellian calculus? Or, to take another case, I choose 3 axioms. I can't derive the same set of propositions from *these* as I can from all 5. Isn't that a material insight? And so can't you look upon a consistency proof as the recognition of something substantial?

Page 324

WITTGENSTEIN: If I first take 3 propositions and then 5 propositions, I can't compare the classes of consequences at all unless I form a *new system* in which both groups occur.

Page 324

And so it isn't as if I have both systems--the one with 3 axioms and the one with 5 axioms--in front of me and now compare them from outside. I can't do that any more than I can compare, say, the integers and the rational numbers until I've brought them into *one* system. And I don't gain a material insight either; what I do is once more to construct a calculus. And in this calculus the proposition 'The one class includes more than the other' doesn't occur at all: that is the prose accompanying the calculus.

Page 324

Can one ask: When have I applied the calculus? Is it possible for me not to know whether I have applied the calculus, and to have to wait until I have a consistency proof?

Page Break 325

Page 325

(Tuesday, 30 December, at Schlick's house)

WAISMANN reads out §117 and §118 of Frege's *Grundgesetze*.

Page 325

WITTGENSTEIN comments:

If one looks at this naïvely, the chief thing that strikes one is that mathematicians are always afraid of only *one* thing, which is a sort of nightmare to them: contradiction. They're not at all worried, e.g. by the possibility of a proposition's being a tautology, even though a contradiction is surely no worse than a tautology. In logic, contradiction has precisely the same significance as tautology, and I could study logic just as well by means of contradictions. A contradiction and a tautology of course *say* nothing, they are only a method for demonstrating the logical interrelations between propositions.

Page 325

It's always: 'the law [Satz] of contradiction'. I believe in fact that the fear of contradiction is bound up with its being construed as a *proposition* [Satz]: $\sim(p \bullet \sim p)$. There's no difficulty in construing the law of contradiction as a

rule: I forbid the formation of the logical product $p \cdot \sim p$. But the contradiction $\sim(p \cdot \sim p)$ doesn't begin to express this prohibition. How could it? The contradiction doesn't say anything at all, but the rule says something.

Page 325

WAISMANN REPEATS HIS QUESTION: You said that by prohibitions and permissions I can always only determine *a* game, but never *the* game. But is that right? Imagine for instance the case where I permit any move in chess and forbid nothing--would that still be a game? Mustn't the rules of a game then still have certain properties for them to define a game at all? Couldn't we then interpret the demand for consistency as one to exclude the 'tautological' game--the game in which anything is permissible? That is to say, if the formula ' $0 \neq 0$ ' can be derived by a legitimate proof and if in addition with Hilbert we add the axiom ' $0 \neq 0 \rightarrow \mathfrak{A}$ ', where \mathfrak{A} stands for an arbitrary formula, then we can derive the formula \mathfrak{A} from the inference pattern

$$\frac{0 \neq 0 \quad 0 \neq 0 \rightarrow \mathfrak{A}}{\mathfrak{A}}$$

Page Break 326

and write it down, too. But that means that in this case *any* formula can be derived, and so the game loses its character and its interest.

Page 326

WITTGENSTEIN: Not at all! There's a mistake here, i.e. a confusion between 'a rule of the game' and 'position in the game'. This is how it is: the game is tautological if the rules of the game are tautological (i.e. if they no longer forbid or permit anything); but that isn't the case here. This game, too, has its own particular rules: it's one game among many, and that the configuration ' $0 \neq 0$ ' arises in it is neither here nor there. It's just a configuration which arises in *this* game, and if I exclude it, then I have a *different* game before me. It simply isn't the case that in the first instance I don't have a game before me but in the second I do. One class of rules and prohibitions borders on another class of rules and prohibitions, but *a game doesn't border on a non-game*. The 'tautological' game must arise as the limit case of games, as their natural limit. The system of games must be delimited from within, and this limit consists simply in the fact that the rules of the game vanish. I can't get this limit case by myself setting up particular rules and prohibitions; for that just gives me once more one game among many. So if I say: The configuration ' $0 \neq 0$ ' is to be permitted, I am once more stating a rule, defining a game; merely a different one from the one where I exclude this configuration.

Page 326

That is to say: by rules I can never define *the* game, always only *a* game.

Page 326

WAISMANN ASKS: There's a theory of chess, isn't there? So we can surely use this theory to help us obtain information about the possibilities of the game--e.g. whether in a particular position I can force mate in 8, and the like. If, now, there is a theory of the game of chess, then I don't see why there shouldn't also be a theory of the game of arithmetic and why we shouldn't apply the propositions of this theory to obtain material information about the possibilities of this game. This theory is Hilbert's metamathematics.

Page Break 327

Page 327

WITTGENSTEIN: What is known as the 'theory of chess' isn't a theory describing something, it's a kind of geometry. It is of course in its turn a calculus and not a theory.

Page 327

To make this clear I ask you whether, in your opinion, there is a difference between the following two propositions: 'I can force mate in 8' and 'By the theory I have proved I can force mate in 8'? No! For if in the theory I use a symbolism instead of a chessboard and chess set, the demonstration that I can mate in 8 consists in my actually doing it in the symbolism, and so, by now doing with signs what I do with pieces on the board. When I make the moves and when I prove their possibility--then I have surely done *the same thing* over again in the proof. I've made the moves with symbols, that's all. The only thing missing is in fact the actual movement; and of course we agree that moving the little piece of wood across the board is inessential.

Page 327

I am doing in the proof what I do in the game, precisely as if I were to say: You, Herr Waismann, are to do a sum, but I am going to predict what digits will be your result: I then simply do the sum for my own part, only perhaps with different signs (or even with the same, which I construe differently). I can now work out the result of

the sum all over again; I can't come to the same result by a totally different route. It isn't as if you are the calculator and I recognize the result of your calculation on the strength of a *theory*. And precisely the same situation obtains in the case of the 'theory of chess'.

Page 327

And so if I establish in the 'theory' that such and such possibilities are present, I am again moving about within the game, not within a metagame. Every *step* in the calculus corresponds to a move in the game, and the whole difference consists only in the physical movement of a piece of wood.

Page 327

Besides, it is highly important that I can't tell from looking at the pieces of wood whether they are pawns, bishops, rooks, etc.

Page Break 328

I can't say: that is a pawn *and* such and such rules hold for this piece. No, it is the rules alone which *define* this piece: a pawn *is* the sum of the rules for its moves (a square is a piece too), just as in the case of language the rules define the logic of a word.

Page 328

WAISMANN RAISES THE OBJECTION: Good, I can see all that. But so far we have only been dealing with the case that the theory says such and such a position is possible. But what if the theory proves the *impossibility* of a certain position--e.g. the 4 rooks in a straight line next to one another? And just this sort of case is dealt with by Hilbert. In this case the theory simply cannot reproduce the game. The steps in the calculus no longer correspond to moves in the game.

Page 328

WITTGENSTEIN: Certainly they don't. But even in this case it must come out that the theory is a calculus, just a different one from the game. Here we have a *new* calculus before us, a calculus with a different multiplicity.

Page 328

In the first instance: *If I prove that I cannot do such and such, I don't prove a proposition, I give an induction.*

Page 328

I can *see* the induction *on the chessboard*, too. I'll explain in a moment what I mean by that. What I prove is that no matter how long I play I can't reach a particular position. A proof like that can only be made by induction. It is now essential for us to be quite clear about the nature of proof by induction.

Page 328

In mathematics there are two sorts of proof:

Page 328

1) A proof proving a particular formula. This formula appears in the proof itself as its last step.

Page 328

2) Proof by induction. The most striking fact here is that the proposition to be proved doesn't itself occur in the proof at all. That is to say, induction isn't a procedure leading to a proposition. Instead, induction shows us an infinite possibility, and the essence of proof by induction consists in this alone.

Page 328

We *subsequently* express what the proof by induction showed us as a proposition and in doing so use the word 'all'. But this proposition adds something to the proof, or better: the proposition stands

Page Break 329

to the proof as a sign does to what is designated. The proposition is a *name* for the induction. It goes proxy for it, it doesn't follow from it.

Page 329

You can also render the induction visible on the chessboard itself, e.g., by my saying I can go there and back, there and back, etc. But the induction no longer corresponds to a move in the game.

Page 329

So if I prove in the 'theory' that such and such a position cannot occur, I have given an induction which shows something but expresses nothing. And so there is also no proposition at all in the 'theory' which says 'such and such is impossible'.

Page 329

Now it will be said that there must still be some connection between the actual game and the induction. And there is indeed such a connection--it consists in the fact that once I have been given the proof by induction I will no longer try to set up this position in the game. Before I might perhaps have tried and then finally given up. Now I

don't try any more. It's exactly the same here as when I prove by induction that there are infinitely many primes or that $\sqrt{2}$ is irrational. The effect of these proofs on the actual *practice* of arithmetic is simply that people stop looking for a 'greatest prime number', or for a fraction equal to $\sqrt{2}$. But here we must be even more precise than this. *Could* people previously search at all? What they did had, to be sure, a certain likeness to searching, but was something of an entirely different sort; they did something, expecting that as a result something else would occur. But that wasn't searching at all, any more than I can search for a way of wagging my ears. All I can do is move my eyebrows, my forehead and such parts of my body in the hope that my ears will move as well. But I can't *know* whether they will, and thus I can't *search* for a way of making them.

Page 329

Within *the* system in which I tell that a number is prime, I can't even ask what the number of primes is. The question only arises when you apply the substantial form to it. And if you have discovered the induction, that's also something different from computing a number.

Page Break 330

Page 330

The inductions correspond to the formulae of algebra (calculation with letters)--for the reason that the internal relations between the inductions are the same as the internal relations between the formulae. The system of calculating with letters is a new calculus; but it isn't related to ordinary numerical calculation as a metacalculus to a calculus. *Calculation with letters isn't a theory*. That's the crucial point. The 'theory' of chess--when it investigates the impossibility of certain positions--is like algebra in relation to numerical calculation. In the same way, Hilbert's 'metamathematics' must reveal itself to be mathematics in disguise.

Page 330

Hilbert's proof: ('Neubegründung der Mathematik', 1922)

Page 330

'But if our formalism is to provide a complete substitute for the earlier theory which actually consists of inferences and statements, then material contradiction must find its formal equivalent' [†1] $a = b$ and $a \neq b$ are never to be simultaneously provable formulae.

Page 330

The demonstration of consistency on Hilbert's simple model does in fact turn out to be inductive: the proof shows us by induction the possibility that signs must continue to occur on and on \rightarrow .

Page 330

The proof lets us see something. But what it shows can't be expressed by a proposition. And so we also can't say: 'The axioms are consistent'. (Any more than you can say there are infinitely many primes. That is prose.)

Page 330

I believe giving a proof of consistency can mean only one thing: looking through the rules. There's nothing else for me to do. Imagine I give someone a long list of errands to run in the town. The list is so long that perhaps I have forgotten one errand and given another instead, or I have put together different people's errands. What am I to do to convince myself that the errands can be

Page Break 331

carried out? I have to run through the list. But I can't 'prove' anything. (We mustn't forget that we are only dealing here with the *rules* of the game and not with its configurations. In the case of geometry, it's perfectly conceivable that when I go through the axioms I don't notice the contradiction.) If I say: I want to check whether the logical product is a contradiction, this comes to the same thing. *Writing it out* in the form of a contradiction only makes the matter *easier*. If you now choose to call that a 'proof', you are welcome to do so: even then it is just a method of making it easier to check. But it must be said: in and of itself even such a proof cannot guarantee that I don't overlook something.

Page 331

No calculation can do what checking does.

Page 331

But suppose I search systematically through the rules of the game? The moment I work within a system, I have a calculus once more; but then the question of consistency arises anew. And so in fact there is nothing for me to do but inspect one rule after another.

Page 331

What would it mean if a calculus were to yield ' $0 \neq 0$ '? It's clear we wouldn't then be dealing with a sort of modified arithmetic, but with a totally different kind of arithmetic, one without the slightest similarity to cardinal

arithmetic. We couldn't then say: in such and such respects it still accords with our arithmetic (as non-Euclidean geometry does with Euclidean--here the modification of an axiom doesn't have such radical implications); no, there wouldn't be the slightest trace of similarity left at all. Whether I can apply such a calculus is another matter.

Page 331

Besides, there are various difficulties here. In the first instance, one thing isn't clear to me: $a = b$ surely only expresses the substitutability of b for a . And so the equation is a rule for signs, a rule of the game. Then how can it be an axiom, i.e. a position in the game? From this angle a formula such as $0 \neq 0$ is utterly unintelligible.

Page Break 332

For it would in fact mean: you can't substitute 0 for 0--am I then supposed to inspect whether perhaps the one 0 has a flourish which the other doesn't? What on earth does such a prohibition mean? It's the same story as if I say $a = a$. That too is rubbish, no matter how often it gets written down. Schoolmasters are perfectly right to teach their children that $2 + 2 = 4$, but not that $2 = 2$. The way children learn to do sums in school is already in perfect order and there's no reason to wish it any stricter. In fact it's also evident that $a = a$ means nothing from the fact that this formula is never used.

Page 332

If, when I was working with a calculus, I arrive at the formula $0 \neq 0$, do you think that as a result the calculus would lose all interest?

Page 332

SCHLICK: Yes, a mathematician would say such a thing was of no interest to him.

Page 332

WITTGENSTEIN: But *excuse* me! It would be enormously interesting that precisely this came out! In the calculus, we are always interested in the result. How strange! This comes out here--and that there! Who would have thought it? Then how interesting if it were a contradiction which came out! Indeed, even at this stage I predict a time when there will be mathematical investigations of calculi containing contradictions, and people will actually be proud of having emancipated themselves even from consistency.

Page 332

But suppose I want to apply such a calculus? Would I apply it with an uneasy conscience if I hadn't already proved there was no contradiction? But how can I ask such a question? If I can apply a calculus, I have simply applied it; there's no subsequent correction. What I can do, I can do. I can't undo the application by saying: strictly speaking that wasn't an application.

Page 332

Need I first wait for a consistency proof before applying a calculus? Have all the calculations people have done so far been really--*sub specie aeterni*--a hostage against fortune? And is it conceivable that a time will come when it will all be shown to be illegitimate? Don't I know what I'm doing? It in fact amounts to a wish to prove that certain propositions are not nonsense.

Page Break 333

Page 333

So the question is this: I have a series of propositions, e.g. $p, q, r...$ and a series of rules governing operations, e.g. \cdot, \vee, \sim , and someone asks: if you apply these rules concerning the operations to the given propositions, can you ever arrive at nonsense? The question would be justified if by 'nonsense' I mean contradiction or tautology. I must then make the rules for forming statements in such a way that these forms do not occur.

Page 333

(1 January 1931, at Schlick's house)

Is one justified in raising the question of consistency? The strange thing here is that we are looking for something and have no idea what it really is we are looking for. How, for example, can I ask whether Euclidean geometry is consistent when I can't begin to imagine what it would be for it to contain a contradiction? What would it be like for there to be a contradiction in it? This question has first to be answered before we investigate such questions.

Page 333

One thing is clear: I can only understand a contradiction [Widerspruch], if it is a contradiction [Kontradiktion] [\dagger]. So I put forward the case in which I have a series of propositions, let's say $p, q, r...$, and form their logical product. I can now check whether this logical product is a contradiction. Is *that* all the question of consistency amounts to? That would take five minutes to settle. Surely in this sense, no one can *doubt* whether the Euclidean axioms are consistent.

Page 333

But what else could the question mean? Perhaps: if we go on drawing inferences sooner or later we will arrive at a contradiction? To that we must say: Have we a method for discovering the contradiction? If not, then there isn't a question here at all. For we cannot search to infinity.

Page 333

WAISMANN: Perhaps we can still imagine something--namely the schema for indirect proof. By analogy, we transfer that to an axiom system. We must distinguish two things: a problem which can be formulated *within* mathematics, which therefore also already possesses a method of solution; and the idea which

Page Break 334

precedes and guides the construction of mathematics. Mathematicians do in fact have such guiding ideas even in the case of Fermat's Last Theorem. I'm inclined to think that the question of consistency belongs to this complex of pre-mathematical questioning.

Page 334

WITTGENSTEIN: What's meant by analogy? E.g. analogy with indirect proof? Here it's like the trisection of an angle. I can't look for a way to trisect an angle. What really happens when a mathematician concerns himself with this question? Two things are possible: (1) He imagines the angle divided into 3 parts (a drawing); (2) He thinks of the construction for dividing an angle into 2 parts, into 4 parts. And this is where the mistake occurs: people think, since we can talk of dividing into 2, into 4 parts, we can also talk of dividing into 3 parts, just as we can count 2, 3 and 4 apples. But trisection--if there were such a thing--would in fact belong to a completely different category, a completely different system, from bisection, quadrisection. In the system in which I talk of dividing into 2 and 4 parts I can't talk of dividing into 3 parts. These are completely different logical structures. I can't group dividing into 2, 3, 4 parts together since they are completely different forms. You can't count forms as though they were actual things. You can't bring them under one *concept*.

Page 334

It's like wagging your ears. The mathematician naturally lets himself be led by associations, by certain analogies with the previous system. I'm certainly not saying: if anyone concerns himself with Fermat's Last Theorem, that's wrong or illegitimate. Not at all! If, for instance, I have a method for looking for whole numbers satisfying the equation $x^2 + y^2 = z^2$, the formula $x^n + y^n = z^n$ can intrigue me. I can allow myself to be intrigued by a formula. And so I shall say: there's a *fascination* here but not a *question*. Mathematical 'problems' always fascinate like this. This kind of fascination is in no way the preparation of a calculus.

Page 334

WAISMANN: But what then is the significance of the proof of the consistency of non-Euclidean geometry? Let's think of the simplest case, that we give a model, say, of two-dimensional Riemannian

Page Break 335

geometry on a sphere. We then have a translation: every concept (theorem) of the one geometry corresponds to a concept (theorem) of the other. If now the theorems in the one case were to include a contradiction, this contradiction would also have to be detectable in the other geometry. And so we may say: the Riemannian axiom system is consistent provided the Euclidean one is. We have then demonstrated consistency relative to Euclidean geometry.

Page 335

WITTGENSTEIN: Consistency 'relative to Euclidean geometry' is altogether nonsense. What happens here is this: a rule corresponds to another rule (a configuration in the game to a configuration in the game). We have a *mapping*. Full stop! Whatever else is said is prose. One says: *Therefore* the system is consistent. But there is no 'therefore', any more than in the case of induction. This is once more connected with the proof being misconstrued, with something being read into it which it doesn't contain. The proof is the proof. *The internal relations in which the rules (configurations) of one group stand to one another are similar to those in which the rules (configurations) of the other group stand. That's what the proof shows and no more.*

Page 335

On *Independence*: Let's suppose we have 5 axioms. We now make the discovery that one of these axioms can be derived from the other four, and so was redundant. I now ask: What's the significance of such a discovery? I believe that the situation here is exactly as it is in the case of Sheffer's discovery that we can get by with one logical constant.

Page 335

Above all, let's be clear: the axioms define--when taken with the rules for development of the calculus--a group of propositions. This domain of propositions isn't also given to us in some other way, but only by the 5

axioms. So we can't ask: Is *the same* domain perhaps also defined by 4 axioms alone? For the domain isn't detachable from the 5 axioms. These 5 axioms and whatever derives from them are--so to speak--my whole world. I can't get outside of this world.

Page 335

Now how about the question: are these 5 axioms independent?

Page Break 336

I would reply: is there a method for settling this question? Here various cases can arise.

Page 336

1) There is no such method. Then the situation is as I've described it: All that I have are the 5 axioms and the rules of development. In that case I can't seek to find out whether one of these axioms will perhaps *ever* emerge as a consequence of the others. And so I can't raise the question of independence at all.

Page 336

2) But suppose now that one of the axioms does come out as the result of a proof, then we haven't at all proved that only 4 axioms are sufficient, that one is redundant. No, I can't come to this insight through a logical inference, I must *see* it, just as Sheffer *saw* that he could get by with one logical constant. I must see the new system in the system within which I am working and in which I perform the proof.

Page 336

It's a matter of seeing, not of proving. No proposition corresponds to what I see--to the possibility of the system. Nothing is claimed, and so neither is there anything I can prove. So if in this case I give 5 axioms where 4 would do, I have simply been guilty of an oversight. For I should certainly have been in a position to know at the outset that one of these 5 axioms was redundant, and if I have written it down all the same, that was simply a mistake. Granted, it isn't enough in this case simply to set up the axioms, we must also prove that they really are independent.

Page 336

Now Hilbert appears to adopt this last course in the case of geometry. However, one important point remains unclear here: is the use of models a *method*? Can I look for a model systematically, or do I have to depend on a happy accident? What if I can't find a model which fits?

Page 336

To summarize: The question whether an axiom system is independent only makes sense if there is a method for deciding the question. Otherwise we can't raise this question at all. And if,

Page Break 337

e.g., someone discovers one axiom to be redundant, then he hasn't proved a proposition, he has read a new system into the old one.

Page 337

And the same goes for consistency.

Page 337

Hilbert's axioms:

I.1 and I.2: 'Any two distinct points A, B define a straight line a '
'Any two distinct points on a straight line define that line.'

Page 337

I already don't know how these axioms are to be construed, what their logical form is.

Page 337

WAISMANN: You can of course write them as truth functions by saying, e.g.: 'for all x , if x is a point, then...', I believe, however, that we miss the real sense of the axioms in this way. We mustn't introduce the points one after another. It seems much more correct to me to introduce the points, lines, planes by means of co-ordinates as it were at one fell swoop.

Page 337

WITTGENSTEIN: That's my view too. But one thing I don't understand: What would it mean to say that these axioms form a contradiction? The position is that as they stand they can't yield a contradiction, unless I determine by a rule that their logical product is a contradiction. That is, the situation with contradiction here is just as it is with the incompatibility of the propositions: 'This patch is green' and 'This patch is red'. As they stand, these propositions don't contradict one another at all. They only contradict one another once we introduce a further rule of syntax forbidding treating both propositions as true. Only then does a contradiction arise. (Cf. above p. 323: the example with 'the sum of the angles of a triangle = 180° '.)

(September 1931)

WAISMANN ASKS: (You said earlier) there was no contradiction at all in the calculus. I now don't understand how that fits in with the nature of indirect proof, for this proof of course depends precisely on producing a contradiction in the calculus.

WITTGENSTEIN: What I mean has nothing at all to do with indirect proof. There's a confusion here. Of course there are contradictions in the calculus; all I mean is this: it makes no sense to talk of a *hidden* contradiction. For what would a hidden contradiction be? I can, e.g., say: the divisibility of 357, 567 by 7 is hidden, that is, as long as I have not applied the criterion--say the rule for division. In order to turn the divisibility from a hidden one into an open one, I need only apply the criterion. Now, is it like that with contradiction? Obviously not. For I can't bring the contradiction into the light of day by applying a criterion. Now I say: then all this talk of a hidden contradiction makes no sense, and the danger mathematicians talk about is pure imagination.

You might now ask: But what if one day a method were discovered for establishing the presence or absence of a contradiction? This proposition is very queer. It makes it look as if you could look at mathematics on an assumption, namely the assumption that a method is found. Now I can, e.g., ask whether a red-haired man has been found in this room, and this question makes perfect sense, for I can describe the man even if he isn't there. Whereas I can't ask after a method for establishing a contradiction, for I can only describe it (the method) once it's there. If it hasn't yet been discovered, I'm in no position to describe it, and what I say are empty words. And so I can't even begin to ask the question what would happen if a method were discovered.

The situation with the method for demonstrating a contradiction is precisely like that with Goldbach's conjecture: what is going on is a random attempt at constructing a calculus. If the attempt succeeds I have a calculus before me again, only a different one from that which I have used till now. But I still haven't proved the calculus is a calculus, nor can that be proved at all.

If someone were to describe the introduction of irrational

numbers by saying he had discovered that between the rational points on a line there were yet more points, we would reply: 'Of course you haven't discovered new points between the old ones: you have constructed new points. So you have a new calculus before you.' That's what we must say to Hilbert when he believes it to be a discovery that mathematics is consistent. In reality the situation is that Hilbert doesn't establish something, he lays it down. When Hilbert says: $0 \neq 0$ is not to occur as a provable formula, he defines a calculus by permission and prohibition.

WAISMANN ASKS: But still you said a contradiction can't occur in the calculus itself, only in the rules. The configurations can't represent a contradiction. Is that still your view now?

WITTGENSTEIN: I would say that the rules, too, form a calculus, but a different one. The crucial point is for us to come to an understanding on what we mean by the term contradiction. For if you mean one thing by it and I mean another, we can't reach any agreement.

The word 'contradiction' is taken in the first instance from where we all use it, namely from the truth functions, and mean, say, $p \bullet \sim p$. So in the first instance we can only talk of a contradiction where it's a matter of assertions. Since the formulae of a calculus are not assertions, there can't be contradictions in the calculus either. But of course you can stipulate that a particular configuration of the calculus, e.g. $0 \neq 0$, is to be called a contradiction. Only then there is always the danger of your thinking of contradiction in logic and so confounding 'contradictory' and 'forbidden'. For if I call a particular configuration of signs in the *calculus* a contradiction, then that only means that the formation of this configuration is forbidden: if in a proof you stumble upon such a formula, something must be done about it, e.g. the opening formula must be struck out.

In order to avoid this confusion, I should like to propose that in place of the word 'contradiction' we use a completely new sign which has no associations for us except what we have explicitly

laid down: let's say the sign S . *In the calculus, don't take anything for granted.* If the formula S occurs, as yet that has no significance at all. We have first to make further stipulations.

WAISMANN ASKS: An equation in arithmetic has a twofold significance: it is a configuration and it is a substitution rule. Now what would happen if in arithmetic or analysis a proof of the formula $0 \neq 0$ were to be found? Then arithmetic would have to be given a completely different meaning, since we wouldn't any longer be entitled to interpret an equation as a substitution rule. 'You cannot substitute 0 for 0' certainly doesn't mean anything. A disciple of Hilbert could now say: there you see what the consistency proof really achieves. Namely this proof is intended to show us that we are entitled to interpret an equation as a substitution rule.

WITTGENSTEIN: That, of course, is something it can't mean. Firstly: how does it come about that we may interpret an equation as a substitution rule? Well, simply, because the grammar of the word 'substitute' is the same as the grammar of an equation. That is why there is from the outset a parallelism between substitution rules and equations. (Both, e.g., are transitive.) Imagine I were to say to you 'You cannot substitute a for a '. What would you do?

WAISMANN: I wouldn't know what to think, since this claim is incompatible with the grammar of the word 'substitute'.

WITTGENSTEIN: Good, you wouldn't know what to think, and quite right too, for in fact you have a new calculus in front of you, one with which you're unfamiliar. If I now explain the calculus to you by giving the grammatical rules and the application, then you will also understand the claim 'You cannot substitute a for a '. You can't understand this claim while you remain at the standpoint of the old calculus. Now, if say the formula $0 \neq 0$ could be proved, that would only mean we have two different calculi before us: one calculus which is the grammar of the verb 'substitute', and another in which the formula $0 \neq 0$ can be proved. These two calculi would then exist alongside one another.

If someone now wanted to ask whether it wouldn't be possible

to prove that the grammar of the word 'substitute' is the same as the grammar of an equation, i.e. that an equation can be interpreted as a substitution rule, we should have to reply: there can be no question of a proof here. For how is the claim supposed to run which is to be proved? That I apply the calculus, after all, only means that I set up rules telling me what to do when this or that comes out in the calculus. Am I then supposed to prove that I have set up rules? For surely that's the only sense the question whether I have applied the calculus can have. I once wrote: the calculus is not a concept of mathematics.

WAISMANN: You said on one occasion that no contradictions can occur in the calculus. If, e.g., we take the axioms of Euclidean geometry and add in the further axiom: 'The sum of the angles of a triangle is 181° ', even this would not give rise to a contradiction. For it could of course be that the sum of the angles has two values, just as does $\sqrt{4}$. Now if you put it like that, I no longer understand what an indirect proof achieves. For indirect proof rests precisely on the fact that a contradiction is derived in the calculus. Now what happens if I lay down as an axiom an assumption which has been refuted by an indirect proof? Doesn't the system of axioms thus extended present a contradiction? For instance: in Euclidean geometry it is proved that you can only drop *one* perpendicular from a point onto a straight line, what's more by an indirect proof. For suppose there are two perpendiculars, then these would form a triangle with two right angles, the sum of whose angles would be greater than 180° , contradicting the well known theorem about the sum of the angles. If I now lay down the proposition 'there are two perpendiculars' as an axiom and add the rest of the axioms of Euclidean geometry--don't I now obtain a contradiction?

WITTGENSTEIN: Not at all. What is indirect proof? Manipulating signs. But that surely isn't everything. A further rule now comes in, too, telling me what to do when an indirect proof is performed. (The rule, e.g., might run: if an indirect proof has been performed,

all the assumptions from which the proof proceeds may not be struck out.) *Nothing is to be taken for granted here.*

Everything must be explicitly spelt out. That this is so easily left undone is bound up with the fact that we can't break away from what the words 'contradiction' etc. mean in ordinary speech.

Page 342

If I now lay down the axiom 'Two perpendiculars can be dropped from one point onto a straight line', the sign picture of an indirect proof is certainly contained in this calculus. But we don't use it as such.

Page 342

What then would happen if we laid down such an axiom? 'I'd reach a point where I wouldn't know how to go on.' Quite right, you don't know how to go on because you have a new calculus before you with which you are unfamiliar. A further stipulation needs making.

Page 342

WAISMANN: But you could always do that when an indirect proof is given in a normal calculus. You could retain the refuted proposition by altering the stipulation governing the use of indirect proof, and then the proposition simply wouldn't be refuted any more.

Page 342

WITTGENSTEIN: Of course we could do that. We have then simply destroyed the character of indirect proof, and what is left of the indirect proof is the mere sign picture.

Page 342

(December 1931)

WAISMANN formulates the problem of consistency:

Page 342

The significance of the problem of consistency is as follows: How do I know that a proposition I have proved by transfinite methods cannot be refuted by a finite numerical calculation? If, e.g., a mathematician finds a proof of Fermat's Last Theorem which uses essentially transfinite methods--say the Axiom of Choice, or the Law of the Excluded Middle in the form: either Goldbach's conjecture holds for all numbers, or there is a number for which it doesn't hold--how do I know that such a theorem can't be refuted by a counter-example? That is not in the least self-evident. And yet it is remarkable that mathematicians place so

Page Break 343

much trust in the transfinite modes of inference that, once such a proof is known, no one would any longer try to discover a counter example. The question now arises: Is this trust justifiable? That is, are we sure that a proposition which has been proved by transfinite methods can never be refuted by a concrete numerical calculation? That's the mathematical problem of consistency.

Page 343

I will at the same time show how the matter seems to stand to me by raising the analogous question for ordinary algebra. How do I know, when I have proved a theorem by calculating with letters, that it can't be refuted by a numerical example? Suppose, e.g., I've proved that $1 + 2 + 3 + \dots + n = [n(n + 1)]/2$ --how do I know this formula can survive the test of numerical calculation? Here we have precisely the same situation. I believe we have to say the following: the reason why a calculation made with letters and a numerical calculation lead to the same result, i.e., the reason why calculating with letters can be applied to concrete numbers, lies in the fact that the axioms of the letter calculus--the commutative, associative laws of addition etc.--are chosen from the outset so as to permit such an application. This is connected with the fact that we choose axioms in accordance with a definite recipe. That is, an axiom corresponds to an induction, and this correspondence is possible because the formulae possess the same multiplicity as the induction, so that we can project the system of induction onto the system of formulae. And so there is no problem in this case, and we can't raise the question at all whether a calculation with letters can even come into conflict with a numerical calculation. But what about analysis? Here there really seems at first sight to be a problem.

Page 343

WITTGENSTEIN: First of all: what are we really talking about? If by 'trust' is meant a disposition, I would say: that is of no interest to me. That has to do with the psychology of mathematicians. And so presumably something else is meant by 'trust'. Then it can only be something which can be written down in symbols. What we

Page Break 344

have to ask about seems to be the reason why two calculations tally. Let's take a quite simple example:

$$2 + (3 + 4) = 2 + 7 = 9$$

$$(2 + 3) + 4 = 5 + 4 = 9$$

I have here performed two independent calculations and arrived on both occasions at the same result. 'Independent' here means: the one calculation isn't a copy of the other. I have two different processes.

And what if they didn't agree? Then there's simply nothing I can do about it. The symbols would then just have a different grammar. The associative and commutative laws of addition hold on the basis of grammar. But in group theory it's no longer the case that $AB = BA$; and so, e.g., we couldn't calculate in two ways, and yet we still have a calculus.

This is how things are: I must have previously laid down when a calculation is to be correct. That is, I must state in what circumstances I will say a formula is proved. Now if the case arose that a formula counted as having been proved on the basis of one method, but as refuted on the basis of another, then that wouldn't in the least imply we now have a contradiction and are hopelessly lost; on the contrary we can say: the formula simply means different things. It belongs to two different calculi. In the one calculus it's proved, in the other refuted. And so we really have two different formulae in front of us which by mere accident have their signs in common.

A whole series of confusions has arisen around the question of consistency.

Firstly, we have to ask where the contradiction is supposed to arise: in the rules or in the configurations of the game.

What is a rule? If, e.g., I say 'Do this and don't do this', the other doesn't know what he is meant to do; that is, we don't allow a contradiction to count as a rule. We just don't call a contradiction a rule--or more simply the grammar of the word 'rule' is such that a contradiction isn't designated as a rule. Now if a contradiction

occurs among my rules, I could say: these aren't rules in the sense I normally speak of rules. What do we do in such a case? Nothing could be more simple: we give a new rule and the matter's resolved.

An example here would be a board game. Suppose there is one rule here saying 'black must jump over white'. Now if the white piece is at the edge of the board, the rule can't be applied any more. We then simply make a new stipulation to cover this case, and with that the difficulty is wiped off the face of the earth.

But here we must be even more precise. We have here a contradiction (namely between the rules 'white must jump over black' and 'you may not jump over the edge of the board'). I now ask: Did we possess a method for discovering the contradiction at the outset? There are two possibilities here:

1) In the board game this possibility was undoubtedly present. For the rule runs: 'In general...' If this means 'in this position and in this position...' then I obviously had the possibility right at the beginning of discovering the contradiction--and if I haven't seen it, that's my fault. Perhaps I've been too lazy to run through all the cases, or I have forgotten one. There's no serious problem present in this case at all. Once the contradiction arises, I simply make a new stipulation and so remove it. We can always wipe the contradiction off the face of the earth.

But whether there is a contradiction can always be settled by inspecting the list of rules. That is, e.g., in the case of Euclidean geometry a matter of five minutes. The rules of Euclidean geometry don't contradict one another, i.e., no rule occurs which cancels out an earlier one (p and $\sim p$), and with that I'm satisfied.

2) But now let's take the second case, that we have no such method. My list of rules is therefore in order. I can't see any contradiction. Now I ask: Is there now still any danger? It's out of the question. What are we supposed to be afraid of? A contradiction? But a contradiction is only given me with the method for discovering it. As long as the contradiction hasn't arisen, it's no concern of mine. So I can quite happily go on calculating. Would

the calculations mathematicians have made through the centuries suddenly come to an end because a contradiction had been found in mathematics? Would we say they weren't calculations? Certainly not. If a contradiction does arise, we will simply deal with it. But we don't need to worry our heads about it *now*.

What people are really after is something quite different. A certain paradigm hovers before their mind's eye, and they want to bring the calculus *into line with this paradigm*.

EDITOR'S NOTE

Page 347

Our text is a typescript that G. E. Moore gave us soon after Wittgenstein's death: evidently the one which Wittgenstein left with Bertrand Russell in May, 1930, and which Russell sent to the Council of Trinity College, Cambridge, with his report in favour of a renewal of Wittgenstein's research grant.[†1] All the passages in it were written in manuscript volumes between February 2nd, 1929, and the last week of April, 1930. The latest manuscript entry typed and included here is dated April 24th, 1930. On May 5th, 1930, Russell wrote to Moore that he had 'had a second visit from Wittgenstein.... He left me a large quantity of typescript which I am to forward to Littlewood as soon as I have read it.' [J. E. Littlewood, F.R.S., Fellow of Trinity College.] In his report to the Council, dated May 8th, Russell says he spent five days in discussion with Wittgenstein, 'while he explained his ideas, and he left with me a bulky typescript, *Philosophische Bemerkungen*, of which I have read about a third. The typescript, which consists merely of rough notes, would have been very difficult to understand without the help of the conversations'. The Council had authorized Moore to ask Russell for a report, and I suppose they asked Moore to return the typescript to Wittgenstein. Wittgenstein asked Moore to take care of it. Apparently he did not keep a copy himself.

Page 347

Wittgenstein had made an earlier visit to Russell, in March, 1930, and Russell wrote to Moore then that 'he intends while in Austria to make a synopsis of his work which would make it much easier for me to report adequately..... He intends to visit me again in Cornwall just before the beginning of the May term, with his synopsis'. Wittgenstein can hardly have called the *Bemerkungen* a synopsis when he gave it to Russell; nor did Russell when he wrote to Moore and then to the Council about it. On the other hand it

Page Break 348

is a selection and a rearrangement of passages from what he had in manuscript and in typescript at the time. It was made from slips cut from a typescript and pasted into a blank ledger in a new order. The 'continuous' typescript was made from Wittgenstein's manuscript volumes I, II, III and the first half of IV. In the typing Wittgenstein left out many of the manuscript passages--more from I and II than from the others. In this typing he changed the order of some large blocks of material. This was nothing like his rearrangement of the slips he cut from it for the *Philosophische Bemerkungen* as Moore gave it to us.

Page 348

It was not 'merely rough notes'. But it was not easy to read, and Wittgenstein would not have published it without polishing. No spacing showed where a group of remarks hang closely together and where a new topic begins. Paragraphs were not numbered. And it was hard to see the arrangement and unity of the work until one had read it a number of times. (Russell did not have time to read it through once.) If he had thought of making this typescript more *übersichtlich* Wittgenstein might have introduced numbers for paragraphs, as he did in the *Brown Book* and in the *Investigations*. He might have divided into chapters, as he did with the typescript of 1932/33 (No. 213)--although he never did this again. (See Part II of *Philosophische Grammatik*.) The 1932/33 typescript was the only one for which he made a table of contents. We cannot guess whether he would have tried to do this for the *Philosophische Bemerkungen*. For the *Blue Book* he gave neither numbers nor chapter divisions. If he did at first think of the *Bemerkungen* which he left with Russell as a 'synopsis' of his writing over the past 18 months, he might have thought of some system of numbering (I am thinking of the *Tractatus*) which would show the arrangement. But I have found no reference or note in this sense.

Page 348

He went on writing directly after he had seen Russell--from the entries in the manuscript volume you would think there had not been a break. He had kept a copy of the typescript he had cut into slips to form the *Philosophische Bemerkungen*. (The top copy, in fact--and the least legible, for the first 60 pages of it: his typewriter ribbon was exhausted and hardly left ink marks. Later he used to dictate to a professional typist.) In a number of places he

Page Break 349

added to what he had typed or revised it--writing in pencil or ink on the back of the typed sheets or between the lines or in the margins. And in certain places he took pages from this copy and cut sections from it--pasting them into manuscript books or clipping them together with slips from other typescripts to form the 1932/33 typescript. In one or two places I have quoted a pencilled revision in a footnote here. But I do not think generally that the revisions he made there can be counted as revisions of the typescript (with its title page and motto) which he had left with

Russell. They belonged to a far-reaching change and development in Wittgenstein's thinking, and a different book.

Page 349

He had arrived in Cambridge sometime in January, 1929, and began his first manuscript volume on February 2nd. (Manuscript 'volume', as distinct from 'notebook': it was generally a hard covered notebook, often a large ledger. Such a volume is never rough notes, as the paper-covered and pocket notebooks often are.) Volumes I and II cannot be separated, for he wrote at first on the right-hand pages only; when he reached the end of volume II in this way he continued what he was writing on the *left*-hand pages of volume II, and when he came to the end of the volume on this side he continued on the left-hand pages of volume I--and on to the end of I. Volume III begins where this leaves off. He started III at the end of August or the beginning of September, 1929. (After the first week he did not date his entries in I and II. The first date in III comes on page 87 of the manuscript. It is: 11.9.29.)

Page 349

He wrote *Some Remarks on Logical Form* to read to the Aristotelian Society and Mind Association Joint Session in July, 1929--but he disliked the paper and when the time came he ignored it and talked about infinity in mathematics. In volumes I and II there are discussions of suggestions he makes in the *Logical Form* paper. The *Philosophische Bemerkungen* has a few of these; but many--those central to the paper, I think--are left out. Some remarks about 'phenomenological language' may refer to the earlier view in that paper. And the first sentence in §46 may refer to the example using coordinates there.

Page 349

In Appendix I: Wittgenstein's typescript of 'Complex and Fact'

Page Break 350

(*Komplex und Tatsache*) is taken from manuscript volume VI, in an entry dated 30.6.31.--more than a year after the last passage in the *Bemerkungen*. It is the first of three sections of what he had put together as a single typescript (now printed together in *Philosophische Grammatik*). These are numbered consecutively as forming a single essay, although they do not come close to one another in the manuscripts. 'Infinitely Long' and 'Infinite Possibility' are numbered consecutively, as though forming one essay, as well. Both groups seem to have been typed along with the 1932/33 typescript and Wittgenstein kept them together with it, but they do not form part of it.

Page 350

Of the two sections that *follow* 'Complex and Fact' in the typescript, about two-thirds of the remarks are here in *Philosophische Bemerkungen*, especially §93 to the end of §98. In the manuscript (volume VI) the discussion of 'complex \neq fact' grows out of 'I describe the fact which would be the fulfilment' of an order or of an expectation--and the apparent difficulty that this description is 'general in character', whereas the 'fulfilment' when it arrives is something you can point to. As though I had painted the apple that was going to grow on this branch, and now the apple itself is there: as though the grown apple was the event I was expecting. But the apple is not an event at all. 'The fact (or event) is described in general terms.' But then the fact is treated as though it were on all fours with a house or some other sort of complex. I expected the man, and my expectation is fulfilled. But *the man I expected* is not the fulfilment; but *that he has come*. This leads directly to 'complex \neq fact'. And this was important for the understanding of '*describing*'.

Page 350

Expectation and fulfilment have a different role in mathematics--not like their role in experience. And in mathematics there is not this distinction.

'In mathematics description and object are equivalent. "The fifth number in this series of numbers has these properties" says the *same* as "5 has these properties". The properties of a house do not *follow* from its position in a row of houses; but the properties of a number are the properties of a position.'

Page 350

You cannot *describe* what you expect to happen in the development of a decimal fraction, except by writing out the calculation

Page Break 351

in which it comes. Wittgenstein used to put this by saying 'the description of a calculation accomplishes the same as the calculation; the description of a language accomplishes the same as the language'.

Page 351

The passage I have quoted comes just before the discussion of 'Infinitely Long' in the manuscript (volume IX). Revising his account of 'description' brought with it a revision of the account of the *application* of mathematics, and especially of the use of expressions like 'infinity' in the mathematical sense for the description of physical happenings.

TRANSLATORS' NOTE

Page 352

This note, like the translation itself, runs the risk of overlying and obscuring the original. Yet we very much wish to express our thanks for help received, and we also feel we should mention one or two significant areas where we are conscious of having only half-resolved the difficulties of translation.

Page 352

Wittgenstein's style often depends on repeating certain words or groups of words in order to create a series of sometimes unexpected interrelations and back-references within the discussion. Some of these terms, e.g. *Raum* [space], have a straightforward English equivalent, whereas others prove less tractable. In such cases to use the same word in English throughout would unduly strain against the natural bent of English usage, whilst varying the English equivalents blunts the point of Wittgenstein's remarks. One term important enough to single out is *Bild*: 'picture' covers much the same area as this term in Wittgenstein's usage, but various phrases, e.g. *Erinnerungsbild* [memory image] are beyond its natural scope. For *Maßstab* we have usually said 'yardstick', since like *Maßstab* it can be used to convey a general notion of measure or standard whilst retaining, to some degree, its characteristics as a measure of length. At times these characteristics come into their own, for instance when Wittgenstein says someone shows his understanding of the notion of height in that he knows it is measured by a *Maßstab* and not by a weighing machine. At another point he reflects that the yardstick [*Maßstab*] needn't of course be a yardstick, it could equally well be a dial or scale with a needle. And, of course, it isn't strictly correct to say that the application is what makes a stick into a yardstick, it makes a stick (of any length) into a measuring stick, or a rod into a measuring rod [*Maßstab*]. Occasionally, we felt that 'ruler' or 'measure' would be more natural--neither of us thought people would keep yardsticks in their pockets--and that such mild variation in equivalents might possibly emphasize the unity of the underlying principle: they are all standards of measurement. A word curiously

Page Break 353

difficult to translate is *suchen*: 'seek', 'search (for)' and 'look (for)' all create difficulties, the first because it has the wrong kind of resonance, the others because of the occurrence of such sentences as 'Tell me how you *suchen*, and I will tell you what you *suchen*'. 'Tell me how you are searching and I will tell you what you are searching for' throws unwanted emphasis on 'for', and it is obvious that 'looking' and 'looking for' don't fit in with this pattern of syntax. We have generally said 'proposition' for *Satz*, but some contexts ask for 'sentence' in English and others for 'theorem'. In such cases important links are lost, and wherever it seemed appropriate we have indicated this fact. The word *Übersichtlichkeit*, which occurs at the beginning of the book, must have given trouble to all translators, who have variously rendered it as 'perspicuity', 'surveyability' and 'synoptic view', whereas we have rendered it freely as 'bird's-eye view'. The idea at stake here is that a range of phenomena is made *übersichtlich* or *übersehbar* when presented in such a way that we can simultaneously grasp the phenomena individually and as a whole, i.e. if their interrelations can be seen or surveyed in their entirety (you could say in *RFM* that a proof is *übersehbar* if it may be taken in as a single proof). Although differing from the German in that it suggests the elimination of the less important elements, 'bird's-eye view' seems to work well enough in our context. However, in view of the use Wittgenstein later makes of this concept, we felt we should signal its presence in the German text and express the hope that 'bird's-eye view' has something of its immediacy and simplicity.

Page 353

In preparing this translation we have received help and encouragement from a number of people, especially members of the Philosophy Department in the University of Leeds, and also members of the German Department. We are indebted to Mrs Inge Hudson for some suggestions about German usage and particularly to Peter Long for suggesting apt and pleasing ways of catching the force of the original at a number of points. Finally, we owe a special debt of gratitude to Rush Rhees for allowing us a completely free hand with the translation and for making considered and valuable suggestions on virtually every paragraph. We hope that these remarks indicate in some degree the extent to which we have benefited from his generosity.

Page Break 354

Page 354

This is a translation of the German edition of *Philosophische Bemerkungen*, edited by Rush Rhees, published Oxford 1964. The only divergences are a few additional footnotes requested by Rush Rhees. The following list of *Corrigenda* to the German edition was prepared by Rush Rhees and ourselves.

Page 354

FOOTNOTES

Page 52

†1] German: Die Oktaeder-Darstellung ist eine *übersichtliche* Darstellung der grammatischen Regeln.

Page 52

†2] German: Unserer Grammatik fehlt es vor allem an *Übersichtlichkeit*.

Page 52

†3] E. Mach, *Erkenntnis und Irrtum*, 2nd ed., Leipzig 1906. p. 186, 191.

Page 61

†1] The German word here is 'Satz', which spans both 'proposition' and 'sentence': in English the translation 'sentence' would frequently become intolerably strained and we have therefore normally rendered 'Satz' by 'proposition': in this context 'sentence' is clearly required and yet this passage should link with those other passages in the book where we have adopted 'proposition' as our translation. [trans.]

Page 76

†1] Cf. diagram on p. 278.

Page 80

†1] ideas = Vorstellungen; the world as idea--Vontellungswelt. [trans.]

Page 82

†1] world of the image = Welt der Vorstellung. [trans.]

Page 85

†1] Maßstab (usually rendered 'yardstick'). [trans.]

Page 89

†1] To be construed by analogy with 'It is snowing'. [trans.]

Page 110

†1] cf. Appendix, p. 317.

Page 124

†1] In the manuscript *W.* precedes this formula by the following definitions:

$$(\exists x)\phi x \stackrel{\text{Def}}{=} (\exists 1)_x\phi(x)$$

$$(\exists x, y)\phi x.\phi y \stackrel{\text{Def}}{=} (\exists 1 + 1)_x\phi(x)$$

$$(\exists x, y, z)\phi x \cdot \phi y \cdot \phi z \stackrel{\text{Def}}{=} (\exists 1 + 1 + 1)_x\phi(x)$$

etc.

further:

$$(\exists n)_x\phi(x) \cdot \sim (\exists n + 1)_x\phi(x) \stackrel{\text{Def}}{=} (n)_x\phi x'$$

and then leads into the formula in the text with the words 'Then you can e.g. write:...' ['Dann kann man z. B. schreiben:...'].]

Page 126

†1] In the manuscript Wittgenstein first wrote 'the proposition *A*' as follows:

Page 126

' $(\exists 2x)\phi x \cdot (\exists 2x)x \cdot \text{Ind.} \supset (\exists 4x)\phi x \vee \psi x \text{--}A$. This proposition doesn't--of course--say that $2 + 2 = 4$ but that the expression is a tautology shows it. ϕ and ψ must be disjoint variables.'

Page 126

He also writes in this connection: 'For isn't ' $(\exists 2x)\phi x \cdot (\exists 2x)\psi x \cdot \text{Ind.} (\exists 4x)\phi x \vee \psi x$ ' an application of $2 + 2 = 4$, just as much as ' $(\exists 2x)\phi x$ etc., etc.'?"

Page 126

By this stage he is using ' $(\exists 2x)\phi x$ ' in contrast with ' $(\exists 2x)\phi x$ ' to mean 'There are exactly two ϕ s', as opposed to 'There are at least two ϕ s'.

Page 128

†1] (Later marginal note): That we can make the calculus with strokes and without tautologies shows we do not need tautologies for it. Everything that does not belong to the number calculus is mere decoration.

Page 129

†1] (Later correction):... only direct insight into the number calculus can tell us... (with a mark of dissatisfaction under the words 'direct insight').

Page 129

†2] (Later marginal note): Instead of a question of the definition of number, it's only a question of the grammar of numerals.

Page 143

†1] Grelling's.

Page 144

†1] 'Chromatic number': a fictitious designation of a number that is perhaps not given by any law or calculation. In the manuscript, W. wrote, among other things:

Page 144

You could ask: What does $(x)2x = x + x$ say? It says that all equations of the form $2x = x + x$ are correct. But does that mean anything? May one say: Yes, I see that all equations of this form are correct, so now I may write ' $(x)2x = x + x$ '?

Page 144

Its meaning must derive from its proof. What the proof proves--that is the meaning of the proposition (neither more nor less)...

Page 144

An algebraic proof is the general form of a proof which can be *applied* to any number. If, referring to this proof, I say I have demonstrated that there is no chromatic number, then this proposition obviously says something other than ' $\sim(\exists n)\bullet\text{Chr } n$ '.

Page 144

And in that case what does the proposition '*There is a chromatic number*' say? It ought, surely, to say the opposite of what was demonstrated by the proof. But then, it doesn't say ' $(\exists n)\bullet\text{Chr } n$ '.

Page 144

If you make the wrong transition from the variable proposition to the general proposition (in the way Russell and Whitehead said was permissible), then the proof looks as if it's only a source for knowledge of the general proposition, instead of an analysis of its actual sense.

Footnote Page Break 145

Page 145

Then you could also say: perhaps the proposition is correct, even though it can't be proved.

Page 145

If this proof yields the proposition $Fa \neq fa$, what in this case is its opposite? (Surely--in our sense--not $Fa = fa$).

Page 145

Indeed, I have here only a form that I have proved possesses certain properties. On the strength of these properties, I can use it now in certain ways, viz. to show in any particular case that the number in question isn't chromatic. I can, of course, negate that form, but that doesn't give me the sense I want, and all I can do now is to deny the proof. But what does that mean? It doesn't of course, mean that it was wrongly--fallaciously--executed, but that it can't be carried out. That then means: the inequality doesn't derive from the forms in question; the forms do not exclude the inequality. But then, what else does? Does the development depend then on something further? That is, can the case arise in which the equation doesn't hold, and the form doesn't exclude it?

Page 149

†1] (Later marginal note): Is ' $(\exists n) 4 + n = 7$ '... α a disjunction? No, since a disjunction wouldn't have the sign 'etc. *ad inf.*' at the end but a term of the form $4 + x$.

Page 149

α is neither the same sort of proposition as 'There are men in this house', nor as 'There's a colour that goes well with this', nor as 'There are problems I find too difficult for me', nor as 'There's a time of day when I like to go for a walk'.

Page 150

†1] In the manuscript: 'that *all* propositions, $\sim p$, $\sim\sim p$, $\sim\sim\sim p$, etc. say the same.'

Page 162

†1] In the manuscript he writes ξ instead of x , cf. above, §125.

†1] W. had just written in the manuscript: One is constantly confused by the thought 'but can there be a possibility without a corresponding reality?'

†1] The only reason why you can't say there are infinitely many things is that there aren't. If there were, you could also express the fact I [Manuscript]

†1] (Later marginal note): Act of *decision*, not *insight*.

†2] This sentence is incomplete in the manuscript. [ed.]

†1] In this connection, W. had written in the manuscript:

I still haven't stressed sufficiently that $25 \times 25 = 625$ is on *precisely* the same level as and of *precisely the same kind* as $x^2 + y^2 + 2xy = (x + y)^2$

In the case of general propositions, what corresponds to the proposition $25^2 \neq 620$? It would be $\sim(x, y)(x + y)^2 = x^2 + y^2$, or in words, it is not a rule that ' $(x + y)^2 = x^2 + y^2$ ', or more precisely, the two sides of this equation--taken in the way the '(x)' indicates--are not equal to one another.'

But this sign '(x)' says exactly the opposite of what it says in non-mathematical cases... i.e. precisely that we should treat the variables in the proposition as constants. You could paraphrase the above proposition by saying 'It isn't correct--if we treat x and y as constants--that $(x + y)^2 = x^2 + y^2$ '.....

$(a + b)^2 = a^2 + 2ab + b^2$ yields $x = 2$

$(x + b)^2 = x^2 + 2xb + b^2$ yields $x = x$ } and refer to the same state of affairs which is also affirmed by $(a + b)^2 = a^2 + 2ab + b^2$. (But is that true?)'

And *after* the remark given in the text: 'But what is meant by knowing the rules for calculating?'

†1] Cf. below p. 178.

†1] By this point in his manuscript Wittgenstein had already written the paragraph in §189: 'I say that the so-called "Fermat's last Theorem"†1 is no kind of *proposition*†1 (not even in the sense of a proposition of arithmetic). It would, rather, correspond to a proof by induction. But if, now, there is a number $F = 0.110000$ etc. and the proof succeeds, then it would surely give us a proof that $F = 0.11$ and surely that's a proposition! Or: it's a proposition in the case of the law F being a number.'

†1 Satz.

†1] Manuscript (a bit earlier): 'Whatever one can tackle is a problem. (So mathematics is all right.)' [In English]

†1] Earlier in the manuscript W. had distinguished 'the real mathematical proposition' (i.e. the proof) from 'the so-called mathematical proposition' (existing without its proof), e.g. in the following context:

'What sort of a proposition is "there is a prime number between 5 and 8"? I would say: "That *shows* itself". And that is correct; but can't we draw attention to this internal state of affairs?...

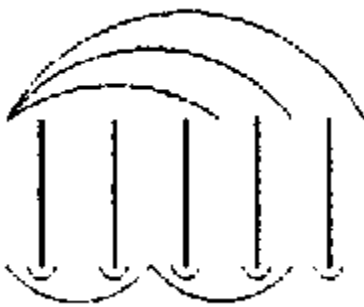

... I can, e.g., write the number 5 in such a way that you can clearly see that it's only divisible by 1 and itself:...

Perhaps this comes down to the same thing as what I meant earlier when I said that the real mathematical proposition is a proof of a so-called mathematical proposition. The real mathematical proposition is the proof: that is to say, the thing which shows how matters stand.'

Page 186

†1] See above p. 132. [ed.]

Page 186

†2] In the sense in which you write history. [ed.]

Page 194

†1] This remark refers to the first section of Th. Skolem's *Begründung der Elementaren Arithmetik durch die Rekurrerende Denkweise ohne Anwendung Scheinbarer Veränderlichen mit Unendlichem Ausdehnungsbereich* (Videnskapsselskapets Skrifter. 1 Math.-Naturv. Klasse 1923, No. 6.). [Translated in van Heijenoort: *From Frege to Gödel*, Harvard University Press, 1967, pp. 302-333.]

Page 194

The text runs:

§1 Addition

Page 194

I will introduce a descriptive function of two variables a and b , which I will designate by means of $a + b$ and call the sum of a and b , in that, for $b = 1$, it is to mean simply the successor of a , $a + 1$. And so this function is to be regarded as already defined for $b = 1$ and arbitrary a . In order to define it in general, I in that case only need to define it for $b + 1$ and arbitrary a , on the assumption that it is already defined for b and arbitrary a . This is done by means of the following definition:

Page 194

Def. 1. $a + (b + 1) = (a + b) + 1$

Page 194

In this manner, the sum of a and $b + 1$ is equated with the successor of $a + b$. And so if addition is already defined for arbitrary values of a for a certain number b , then by Def. 1 addition is explained for $b + 1$ for arbitrary a , and

Footnote Page Break 195

thereby is defined in general. This is a typical example of a recursive definition.

Page 195

Theorem 1. The associative law: $a + (b + c) = (a + b) + c$.

Page 195

Proof: The theorem holds for $c = 1$ in virtue of Def. 1. Assume that it is valid for a certain c for arbitrary a and b .

Page 195

Then we must have, for arbitrary values of a and b

$$(\alpha) \quad a + (b + (c + 1)) = a + ((b + c) + 1)$$

since, that is to say, by Def. 1 $b + (c + 1) = (b + c) + 1$. But also by Def. 1

$$(\beta) \quad a + ((b + c) + 1) = (a + (b + c)) + 1.$$

Now, by hypothesis, $a + (b + c) = (a + b) + c$, whence

$$(\gamma) \quad (a + (b + c)) + 1 = ((a + b) + c) + 1.$$

Finally, by Def. 1 we also have

$$(\delta) \quad ((a + b) + c) + 1 = (a + b) + (c + 1).$$

From (α) , (β) , (γ) , and (δ) there follows

$$a + (b + (c + 1)) = (a + b) + (c + 1),$$

whence the theorem is proved for $c + 1$ with a and b left undetermined. Thus the theorem holds generally. This is a typical example of a recursive proof (proof by complete induction).

Page 194

In the margin of his copy, Wittgenstein drew arrows pointing to 'Theorem 1' and to (α) and wrote: 'the c is a different kind of variable in these two cases'. He puts a question mark against the equals sign in (γ) ; and another

question mark and 'Transition?' against the words 'whence the theorem is proved for $c + 1$ with a and b left undetermined'. Cf. above footnote on p. 144: 'If one makes the wrong transition from a variable proposition to a general proposition....'

Page 198

$$\dagger 1] a + (b + c) = (a + b) + c.$$

Page 198

$$\dagger 2] a + (b + 1) \stackrel{\text{Def}}{=} (a + b) + 1.$$

Page 204

$\dagger 1]$ Fundamental Theorem = Hauptsatz, proposition = Satz. [trans.]

Page 210

$\dagger 1]$ In the notebook W. then wrote: 'Strangely enough the general concept of the ancestral relation also seems to me to be nonsense now. It seems to me that the variable n must always be confined as lying within two limits.'

Page 210

$\dagger 2]$ 'If it were admissible to write ' $(\exists nx) \cdot \phi x$ ' instead of ' $(\exists x) \cdot \phi x$ ', then it would be admissible to write ' $(nx) \cdot \phi x$ ' instead of ' $\sim(\exists x) \sim \cdot \phi x$ '--and so of ' $(x) \cdot \phi x$ '--and that presupposes that there are infinitely many objects.

Page 210

And so the $(\exists nx)...$, if it has any justification at all, here may not mean 'there is one among all the numbers...'
[Manuscript]

Page 220

$\dagger 1]$ (Later gloss): This isn't true! The process of measuring! Nothing determines what the outcome of the process of bisection is going to be.

Page 222

$\dagger 1]$ In this, and the following paragraphs: rule = Vorschrift (prescription). [trans.]

Page 222

$\dagger 2]$ In Russell's sense of type. [trans.]

Page 224

$\dagger 1]$ This sign is to express the prescription: write out the digits of $\sqrt{2}$: but whenever a 5 occurs in $\sqrt{2}$, substitute a 3 for it. Wittgenstein also writes this prescription in the form $\sqrt[4]{\sqrt{2} \cdot \sqrt{2}}$ means: $\sqrt{2}$ expanded to 4 places in a given

Footnote Page Break 225

system--say the decimal system. Sometimes he also writes $\overset{7 \rightarrow 3}{\pi}$, or π' , and that means: write out the decimal expansion of π , but whenever a 7 occurs, substitute a 3 for it. " $\overset{\pi}{4}$ " would mean: π expanded to 4 places (e.g. in the decimal system). Thus $\overset{\pi}{1}$ would be 3, $\overset{\pi}{2}$, 3.1 in the decimal system.

Page 226

$\dagger 1]$ Cf. for example what A. Fränkel says about Cantor's "diagonal number": "... for whilst in general, for every k , δ_k is to be set equal to 1, this rule is subject to an exception solely for those values of k for which the digit 1 is already in the relevant diagonal place of Φ , i.e. at the position of the k th digit of the k th decimal fraction; for such, and only for such, values of k , δ_k is to be set equal to 2." *Einleitung in die Mengenlehre*, 3rd ed. 1928, p. 47. [ed.]

Page 232

$\dagger 1]$ Theorem, proposition = Satz. [trans.]

Page 237

$\dagger 1]$ Cf. The opening sentence of §189 (p. 232 above), and below p. 240.

Page 238

$\dagger 1]$ (Manuscript): What about an operation such as $x)(y$; we form the product of x and y ; if it is greater than 100, the result is the greater of the two numbers, otherwise it is 0?

Page 238

12)(10 = 12. The operation isn't arithmetically comprehensible.

Page 239

$\dagger 1]$ The words 'of the summation' have been added in the translation to make clearer Wittgenstein's meaning in this highly compressed paragraph: we take the 'stages' referred to in the original as referring to the stages in some method of computing e , and for what Wittgenstein says here to be true, he must have in mind a method such as the summing of the usual series for e , which produces a monotone increasing series of approximations. [trans.]

†2] Similar to the above: 'Is 3.14 the circumference of a unit circle? No, it's the perimeter of a ----gon.'

[Manuscript]

†1] (Manuscript): I once asked: 'How can I call a law which represents the endless nesting of intervals anything but a number?'--But why do I term such a nesting a number?--Because we can significantly say that every number lies to the left or right of this nesting.

†1] Nicod, *The Foundations of Geometry and Induction*.

†1] Throughout this section we have translated 'verschwommen' by either 'vague' or 'blurred' for purely stylistic reasons. [trans.]

†1] As Wittgenstein has written these two propositions, the word 'equal' doesn't occur; but this hardly matters.

†2] In the first chapter of *Analysis of Sensations*, p. 19.

†1] Cf. below, p. 285. [ed.]

†1] Francis Galton, *Inquiries into Human Faculty*, London, 1883, Ch. 1 and Appendix A on 'Composite portraiture'.

†1] In the manuscript, Wittgenstein writes this sentence in the form, 'Die beobachtete Verteilung von Ereignissen kann mich zu dieser Annahme führen.' ['The observed distribution of events can lead me to this assumption.'] In the typescript the 'mich' is changed to 'nicht'; this is the reading given in

the German text and which we have followed. It is possible that the typescript reading is a misprint, but it does seem to make neatest sense in the context, provided one allows the slightly strained way of taking 'kann nicht', ['The observed distribution of events cannot lead to this assumption' appears not to fit the context at all.] [trans.]

†* The following translations have been used throughout this discussion: *Tat*, act; *Tatsache*, fact; *Ereignis*, event; *hinweisen auf*, point out; *zeigen auf*, point at. The one nuance it seems impossible to pick up in English is the link between '*Diese Tatsache besteht*' = 'this fact obtains' and '*Dieser Komplex besteht aus...*' = 'this complex is composed of'; we have rendered the noun from *bestehen*, '*Bestandteil*', 'component part'; in translations of the *Tractatus* and other related discussions these last two are usually rendered 'consists of', 'constituent' (as Wittgenstein indicates in the last paragraph). [trans.]

†1] Cf. §145, p. 165, 166.

†1] See p. 166.

†2] In the Manuscript, this sentence immediately follows the paragraph about the red spheres.

†1] An apparent reference to a remark of H. Hahn.

†1] Cf. §142, p. 162.

†1] Cf. §147, p. 169; §212, p. 265.

†1] Cf. §139, p. 159; §144, p. 164.

†1] 'Die Idee des Widerspruchs ist die Kontradiktion'. The use of the ordinary German word for contradiction and the (practically synonymous) loan-word gives to this sentence overtones difficult to reproduce in English. The main point of the remark seems to be 'Look, by a contradiction we must mean a *contradiction*' (Everything's what it is and not another thing), where he goes on to spell out what is involved in the notion of contradiction, and what can

be overlooked in talking of contradictions within calculi. But there are additional overtones introduced by the fact that the word *Kontradiktion* is the word used in the *Tractatus* as the converse of *Tautologie*. It would produce artificialities to translate *Widerspruch* and *Kontradiktion* by different words: in most contexts Wittgenstein uses them virtually interchangeably. Where this has seemed the most natural rendering (as in 'consistency proof') we have translated 'Widerspruch' by 'inconsistency'. We think that the force of Wittgenstein's remarks comes over clearly enough to render clumsy and unnecessary the use of different standard translations for the two words. [trans.]

Page 323

†1] Cf. D. Hilbert *Neubegründung der Mathematik*, Gesammelte Abhandlungen III, p. 74.

Page 330

†1] D. Hilbert: Gesammelte Abhandlungen III, p. 170.

Page 333

†1] Cf. Footnote on p. 321 above.

Page 347

†1] *The Autobiography of Bertrand Russell*, Volume II, pp. 196-200. London, 1968.

PHILOSOPHICAL GRAMMAR

Page 1

Page Break 2

Page Break 3

Titlepage

Page 3

LUDWIG WITTGENSTEIN: PHILOSOPHICAL GRAMMAR

PART I: The Proposition and its Sense

PART II: On Logic and Mathematics

Edited by
RUSH RHEES

Translated by
ANTHONY KENNY

BASIL BLACKWELL

Page Break 4

Copyright page

Page 4

Copyright © Basil Blackwell Ltd 1974

First published 1974
Paperback edition 1980
Reprinted 1988, 1990, 1993

Blackwell Publishers
108 Cowley Road, Oxford OX4 1JF, UK

All rights reserved. Except for the quotation of short passages for the purposes of criticism and review, no part of this publication may be reproduced, stored in a retrieval system, or transmitted, in any form or by any means, electronic, mechanical, photocopying, recording or otherwise, without the prior permission of the publisher.

Except in the United States of America, this book is sold subject to the condition that it shall not, by way of trade or

otherwise, be lent, resold, hired out, or otherwise circulated without the publisher's prior consent in any form of binding or cover other than that in which it is published and without a similar condition including this condition being imposed on the subsequent purchaser.

ISBN 0 631 11891 8

Printed in Great Britain by Athenæum Press, Newcastle-upon-Tyne
This book is printed on acid-free paper

Page Break 5

CONTENTS

Part I: The Proposition and its Sense

Page 5

I

Page 5

- 1 How can one talk about "understanding" and "not understanding" a proposition?
Surely it's not a proposition until it's understood? 39

Page 5

- 2 Understanding and signs. Frege against the formalists. Understanding like seeing a picture that makes all the rules clear; in that case the picture is itself a sign, a calculus.
"To understand a language"--to take in a symbolism as a whole.
Language must speak for itself. 39

Page 5

- 3 One can say that meaning drops out of language.
In contrast: "Did you mean that seriously or as a joke?"
When we *mean* (and don't just say) words it seems to us as if there were something coupled to the words.
41

Page 5

- 4 Comparison with understanding a piece of music: for explanation I can only translate the musical picture into a picture in another medium--and why just *that* picture? Comparison with understanding a picture. Perhaps we see only patches and lines--"we do not understand the picture". Seeing a genre-picture in different ways.
41

Page 5

- 5 "I understand that gesture"--it says something.
In a sentence a word can be felt as belonging first with one word and then with another.
A 'proposition' may be what is conceived in different ways or the way of conceiving itself.

Page Break 6

A sentence from the middle of a story I have not read.
The concept of understanding is a fluid one. 42

Page 6

- 6 A sentence in a code: at what moment of translating does understanding begin?
The words of a sentence are arbitrary; so I replace them with letters. But now I cannot immediately think the sense of the sentence in the new expression.
The notion that we can only imperfectly *exhibit* our understanding; the expression of understanding has something missing that is *essentially* inexpressible. But in that case it makes no sense to speak of a more complete expression. 43

Page 6

- 7 What is the criterion for an expression's being meant *thus*? A question about the relationship between two linguistic expressions. Sometimes a translation into another mode of representation. 45

Page 6

- 8 Must I understand a sentence to be able to act on it? If "to understand a sentence" means somehow or other to act on it, then understanding cannot be a precondition for our acting on it.--What goes on when I suddenly understand someone else? There are *many* possibilities here. 45

Page 6

- 9 Isn't there a gap between an order and its execution? "I understand it, but only because I add something to it,

namely the interpretation."--But if one were to say "any sentence still stands in need of an interpretation", that would mean: no sentence can be understood without a rider. 46

Page 6

10 "Understanding a word"--*being able* to apply it.--"When I said 'I can play chess' I really could." How did I know that I could? My answer will show in what way I use the word "can".

Being able is called a *state*. "To describe a state" can mean various things. "After all I can't have the whole mode of application of a word in my head all at once." 47

Page Break 7

Page 7

11 It is not a question of an instantaneous grasping.--

When a man who knows the game watches a game of chess, the experience he has when a move is made usually differs from that of someone else watching without understanding the game. But this experience is not the knowledge of the rules.--The understanding of language seems like a background; like the *ability* to multiply.

Page 7

12 *When* do we understand a sentence?--When we've uttered the whole of it? Or while uttering it?

50

Page 7

13 When someone interprets, or understands, a sign in one sense or another, what he is doing is taking a step in a calculus.--"Thought" sometimes means a process which may accompany the utterance of a sentence and sometimes the sentence itself in the system of language. 50

Page 7

II

14 Grammar as (e.g.) the geometry of negation. We would like to say: "Negation has the property that when it is doubled it yields an affirmation". But the rule doesn't give a further description of negation, it constitutes negation. 52

Page 7

15 Geometry no more speaks about cubes than logic does about negation.

It looks as if one could *infer* from the meaning of negation that " $\sim\sim p$ " means p . 52

Page 7

16 What does it mean to say that the "is" in "The rose is red" has a different meaning from the "is" in "twice two is four"? Here we have *one* word but as it were different *meaning-bodies* with a single end surface: different possibilities of constructing sentences. The comparison of the glass cubes. The rule for the arrangement of the red sides contains the possibilities, i.e. the geometry of the cube. The cube can also serve as a notation for the rule if it belongs to a system of propositions. 53

Page Break 8

Page 8

17 "The grammatical possibilities of the negation-sign". The T-F notation can illustrate the meaning of "not". The written symbol becomes a sign for negation only by the way it *works*--the way it is used in the game. 55

55

Page 8

18 If we derive geometrical propositions from a drawing or a model, then the model has the role of a sign in a game. We use the drawing of a cube again and again in different contexts. It is this *sign* that we take to be the cube in which the geometrical laws are already laid up. 55

55

Page 8

19 My earlier concept of meaning originates in a primitive philosophy of language.--Augustine on the learning of language. He describes a calculus of our language, only not everything that we call language is this calculus. 56

56

Page 8

20 As if words didn't also have functions quite different from the naming of tables, chairs, etc.--Here is the origin of the bad expression: a fact is a complex of objects. 57

57

Page 8

21 In a familiar language we experience different parts of speech as different. It is only in a foreign language that we see clearly the uniformity of words. 58

58

Page 8

22 If I decide to use a new word instead of "red", how would it come out that it took the place of the word "red"?

23 The meaning of a word: what the explanation of its meaning explains. (If, on the other hand by "meaning" we mean a characteristic sensation, then the explanation of meaning would be a cause.) 59

24 Explanation can clear up misunderstandings. In that case understanding is a correlate of explanation.--Definitions.

It seems as if the other grammatical rules for a word had to follow from its ostensive definition. But is this definition really unambiguous? One must understand a great deal of a language in order to understand the definition. 60

25 The words "shape", "colour" in the definitions determine the *kind of use* of the word. The ostensive definition has a different role in the grammar of each part of speech. 61

26 So how does it come about that on the strength of this definition we understand the word?

What's the sign of someone's understanding a game? Can't he learn a game simply by watching it being played? Learning and speaking without explicit rules. We are always *comparing* language with a game according to rules. 61

27 The names I give to bodies, shapes, colours, lengths have different grammars in each case. The meaning of a name is not the thing we point to when we give an ostensive definition of the name. 63

28 What constitutes the meaning of a word like "perhaps"?

I know how it is used. The case is similar when someone is explaining to me a calculation "that I don't quite understand". "Now I know how to go on." How do I know that I know how to go on? 64

29 Is the meaning really only the use of the word? Isn't it the way this use meshes with our life? 65

30 The words "fine", "oh", "perhaps"... can each be the expression of a feeling. But I don't call that feeling the meaning of the word.

I can replace the sensations by intonation and gestures.

I could also treat the word (e.g. "oh") itself as a gesture. 66

31 A language spoken in a uniform metre.

Relationships between tools in a toolbox.

"The meaning of a word: its role in the calculus of language." Imagine how we calculate with "red". And then: the word "oh"--what corresponds now to the calculus? 67

32 Describing ball-games. Perhaps one will be unwilling to call some of them ball-games; but it is clear where the boundary is to be drawn here?

We consider language from one point of view only.

The explanation of the purpose or the effect of a word is not what we call the explanation of its meaning. It may be that if it is to achieve its effect a particular word cannot be replaced by any other, just as it may be that a gesture cannot be replaced by any other.--We only bother about what's called the explanation of meaning and not about meaning in any other sense. 68

33 Aren't our sentences parts of a mechanism? As in a pianola? But suppose it is in bad condition? So it is not the effect but the purpose that is the sense of the signs (the holes in the pianola roll). Their purpose *within* the mechanism.

We need an explanation that is *part of the calculus*.

"A symbol is something that produces this effect."--How do I know that it is *the one I meant*?"

We could use a colour-chart: and then our calculus would have to get along with the visible colour-sample.

69

Page 10

34 "We could understand a penholder too, if we had given it a meaning." Does the understanding contain the whole system of its application?

Page Break 11

When I read a sentence with understanding something happens: perhaps a picture comes into my mind. But before we call "understanding" is related to countless things that happen before and after the reading of *this* sentence.

When I don't understand a sentence--that can be different things in different cases.

"Understanding a word"--that is infinitely various. 71

Page 11

35 "Understanding" is not the name of a single process but of more or less interrelated processes against a background of the actual use of a learnt language.--We think that if I use the word "understanding" in all these cases there must be some one thing that happens in all of them. Well, the concept-word certainly does show a kinship but this need not be the sharing of a common property or constituent.--The concept-word "game". "By 'knowledge' we mean these processes, and these, and *similar ones*." 74

Page 11

III

36 If for our purposes we wish to regulate the use of a word by definite rules, then alongside its fluctuating use we set a different use. But this isn't like the way physics gives a simplified description of a natural phenomenon. It is not as if we were saying something that would hold only of an ideal language. 77

Page 11

37 We understand a genre-picture if we recognize what the people in it are doing. If this recognition does not come easily, there is a period of doubt followed by a familiar process of recognition. If on the other hand we take it in at first glance it is difficult to say what the understanding--the recognition say--consists of. There is no one thing that happens that could be called recognition.

If I want to say "I understand it *like that*" then the "*like that*" stands for a translation into a different expression. Or is it a sort of intransitive understanding? 77

Page Break 12

Page 12

38 Forgetting the meaning of a word. Different cases. The man feels, as he looks at blue objects, that the connection between the word "blue" and the colour has been broken off. We might restore the connection in various ways. The connection is not made by a single phenomenon, but can manifest itself in very various processes. Do I mean then that there is no such thing as understanding but only manifestations of understanding?--a senseless question. 79

Page 12

39 How does an ostensive definition work? Is it put to work again every time the word is used? Definition as a part of the calculus acts only by being applied. 80

Page 12

40 In what cases shall we say that the man understands the word "blue"? In what circumstances will *he* be able to say it? or to say that he understood it in the past?

If he says "I picked the ball out by guesswork, I didn't understand the word", ought we to believe him? "He can't be wrong if he says that he didn't understand the word": a remark on the grammar of the statement "I didn't understand the word". 81

Page 12

41 We call understanding a mental state, and characterize it as a *hypothetical* process. Comparison between the grammar of mental processes and the grammar of brain processes.

In certain circumstances both our picking out a red object from others on demand and our being able to give the ostensive definition of the word "red" are regarded as signs of understanding.

We aren't interested here in the difference between thinking out loud (or in writing) and thinking in the imagination.

What we call "understanding" is not the behaviour that shows us the understanding, but a state of which this behaviour is a sign. 82

Page Break 13

42 We might call the recital of the rules on its own a criterion of understanding, or alternatively tests of use on their own. Or we may regard the recital of the rules as a symptom of the man's being able to do something other than recite the rules.

To understand = to let a proposition work on one.

When one remembers the meaning of a word, the remembering is not the mental process that one imagines at first sight.

The psychological process of understanding is in the same case as the arithmetical object Three.

84

43 An explanation, a chart, is first used by being looked up, then by being looked up in the head, and finally as if it had never existed.

A rule as the cause or history behind our present behaviour is of no interest to us. But a rule can be a hypothesis, or can itself enter into the conduct of the game. If a disposition is hypothesized in the player to give the list of rules on request, it is a disposition analogous to a physiological one. In our study of symbolism there is no foreground and background.

85

44 What interests *us* in the sign is what is embodied in the grammar of the sign. 87

IV

45 The ostensive definition of signs is not an *application* of language, but part of the grammar: something like a rule for translation from a gesture language into a word-language.--What belongs to grammar are all the conditions necessary for comparing the proposition with reality--all the conditions necessary for its sense.

88

46 Does our language consist of primary signs (gestures) and secondary signs (words)?

Obviously we would not be able to replace an ordinary sentence by gestures.

"Is it an accident that in order to define the signs I have to go outside the written and spoken signs?" In that case isn't it strange that I can do anything at all with the written signs? 88

47 We say that a red label is the primary sign for the colour red, and the word a secondary sign.--But must a Frenchman have a red image present to his mind when he understands my explanation "red = rouge"?

89

48 Are the primary signs incapable of being misinterpreted? Can one say they don't any longer need to be *understood*?

90

49 A colour chart might be arranged differently or used differently, and yet the words mean the same colours as with us.

Can a green label be a *sample* of red?

Can it be said that when someone is painting a certain shade of green he is *copying* the red of a label?

A sample is not used like a name.

90

50 "Copy" can mean various things. Various methods of comparison.

We do not understand what is meant by "this shade of colour is a copy of this note on the violin." It makes no sense to speak of a projection-method for association.

91

51 We can say that we communicate by signs whether we use words or samples, but the game of acting in accordance with words is different from the game of acting in accordance with samples.

92

52 "There must be some sort of law for reading the chart.--Otherwise *how would one know* how the table was to be used?" It is part of human nature to understand pointing with the finger in the way we do.

The chart does not compel me to use it always in the same way. 93

53 Is the word "red" enough to enable one to look for something red? Does one need a memory image to do so?

An order. Is the real order "Do now what you remember doing then?"

If the colour sample appears darker than I remember it being yesterday, I need not agree with my memory.

94

54 "Paint from memory the colour of the door of your room" is no more unambiguous than "paint the green you see on this chart."

I see the colour of the flower and recognize *it*.

Even if I say "no, this colour is brighter than the one I saw there," there is no process of comparing two simultaneously given shades of colour.

Think of reading aloud from a written test (or writing to dictation). 95

55 "Why do you choose *this* colour when given this order?"--"Because *this* colour is opposite to the word 'red' in my chart." In that case there is no sense in *this* question: "Why do you call 'red' the colour in the chart opposite the word 'red'?"

The connection between "language and reality" is made by definitions of words--which belong to grammar.

96

56 A gesture language used to communicate with people who have no word-language in common with us. Do we feel there too the need to go outside language to explain its signs?

The correlation between objects and names is a part of the symbolism. It gives the wrong idea if you say that the connection is a psychological one. 97

57 Someone copies a figure on the scale of 1 to 10. Is the understanding of the general rule of such mapping contained in the process of copying?

Or was the process merely *in agreement with* that rule, but also in agreement with other rules?

97

58 Even if my pencil doesn't always do justice to the model, my intention always does. 98

59 For our studies it can never be essential that a symbolic phenomenon occurs in the mind and not on paper.

An explanation of a sign can replace the sign itself--this contrasts with causal explanation. 99

60 Reading.--Deriving a translation from the original may also be a visible process.

Always what represents is the system in which a sign is used.

If 'mental' processes can be true and false, their descriptions must be able to as well. 99

61 Every case of deriving an action from a command is the same kind of thing as the written derivation of a result.

"I write the number '16' here *because* it says 'x²' there."

It might appear that some causality was operating here, but that would be a confusion between 'reason' and 'cause'. 101

V

62 "That's *him*"--that contains the whole problem of representation.

I make a plan: I see myself acting thus and so. "How do I know that it's myself?" Or "How do I know that the word 'I' stands for me?"

The delusion that in thought the objects do what the proposition states about them.

"I meant the victor of Austerlitz"--the past tense, which looks as if it was giving a description, is deceptive.

102

63 "How does one think a proposition? How does thought use its expression?"

Let's compare belief with the utterance of a sentence: the processes in the larynx etc. *accompany* the spoken sentence which alone interests us--not as part of a mechanism, but as part of a calculus.

We think we can't describe thought after the event because the delicate processes have been lost sight of.

What is the function of thought? Its *effect* does not interest us. 103

Page 17

64 But if thinking consists only in writing or speaking, why shouldn't a machine do it?

Could a machine be in pain?

It is a travesty of the truth to say: thinking is an activity of our mind, as writing is an activity of the hand.

105

Page 17

65 'Thinking' 'Language' are fluid concepts.

The expression "mental process" is meant to distinguish 'experience' from 'physical processes'; or else we talk of 'unconscious thoughts'--of processes in a mind-model; or else the word "thought" is taken as synonymous with "sense of a sentence". 106

Page 17

66 The idea that one language in contrast to others can have an order of words which corresponds to the order of thinking.

Is it, as it were, a contamination of the sense that we express it in a particular language? Does it impair the rigour and purity of the proposition $25 \times 25 = 625$ that it is written down in a particular number system?

Thought can only be something common-or-garden. But we are affected by this concept as we are by that of the number one. 107

Page 17

67 What does man think for? There is no such thing as a "thought-experiment".

Page Break 18

I believe that more boilers would explode if people did not calculate when making boilers. Does it follow that there will in fact be fewer? The belief that fire will burn me is of the same nature as the fear that it will burn me.

109

Page 18

68 My assumption that this house won't collapse may be the utterance of a sentence which is part of a calculation. I do have reasons for it. *What* counts as a reason for an assumption determines a calculus.--So is the calculus something we adopt arbitrarily? No more so than the fear of fire.

As long as we remain in the province of true-false games a change of grammar can only lead us from one game to another, and never from something true to something false. 110

Page 18

VI

69 What is a proposition?--Do we have a single general concept of proposition? 112

Page 18

70 "What happens when a new proposition is taken into the language: what is the criterion for its being a *proposition*?"

In this respect the concept of number is like the concept of proposition. On the other hand the concept of cardinal number can be called a rigorously circumscribed concept, that's to say it's a concept in a different sense of the word. 113

Page 18

71 I possess the concept 'language' from the languages I have learnt. "But language can expand": if "expand" makes sense here, I must *now* be able to specify how I imagine such an expansion.

No sign leads us beyond itself.

Does every newly constructed language broaden the concept of language?--Comparison with the concept of number. 114

Page Break 19

Page 19

72 The indeterminacy of generality is not a logical indeterminacy.

The task of philosophy is not to create an ideal language, but to clarify the use of existing language.

I'm allowed to use the word "rule" without first tabulating the rules for the word.--If philosophy was concerned with the concept of the calculus of all calculi, there would be such a thing as metaphilosophy. But there is

not. 115

Page 19

73 It isn't on the strength of a particular property, the property of being a rule, that we speak of the rules of a game.--We use the word "rule" in contrast to "word", "projection" and some other words.

116

Page 19

74 We learnt the meaning of the word "plant" by examples. And if we disregard hypothetical dispositions, these examples stand only for themselves.--

The grammatical pace of the word "game" "rule" etc is given by examples in rather the way in which the place of a meeting is specified by saying that it will take place *beside* such and such a tree. 117

Page 19

75 Meaning as something which *comes before* our minds when we hear a word.

"Show the children a game".

The sentence "The Assyrians knew various games" would strike us as curious since we wouldn't be certain that we could give an example. 118

Page 19

76 Examples of the use of the word "wish". Our aim is not to give a theory of wishing, which would have to explain every case of wishing.

The use of the words "proposition", "language", etc. has the haziness of the normal use of concept-words in our language. 119

Page 19

77 The philosophy of logic speaks of sentences and words in the sense in which we speak of them in ordinary life.

Page Break 20

(We are not justified in having any more scruples about our language than the chess player has about chess, namely none.) 121

Page 20

78 Sounding like a sentence. We don't call everything 'that sounds like a sentence' a sentence.--If we disregard sounding like a sentence do we still have a general concept of proposition?

The example of a language in which the order of the words in a sentence is the reverse of the present one. 122

Page 20

79 The definition "A proposition is whatever can be true or false".--The words "true" and "false" are items in a particular notation for the truth-functions.

Does "p' is true" state anything about the sign 'p'? 123

Page 20

80 In the schema "This is how things stand" the "how things stand" is a handle for the truth-functions.

A general propositional form determines a proposition as part of a calculus. 124

Page 20

81 The rules that say that such and such a combination of words yields no sense.

"How do I know that red can't be cut into bits?" is not a question. I must *begin* with the distinction between sense and nonsense. I can't give it a foundation. 125

Page 20

82 "How must we make the grammatical rules for words if they are to give a sentence sense?"--

A proposition shows the possibility of the state of affairs it describes. "Possible" here means the same as "conceivable"; representable in a particular system of propositions.

The proposition "I can imagine such and such a colour transition connects the linguistic representation with another form of representation; it is a proposition of grammar. 127

Page 20

83 It looks as if we could say: Word-language allows of senseless combinations of words, but the language of imagining does not allow us to imagine anything senseless.

Page Break 21

"Can you imagine it's being otherwise?"--How strange that one should be able to say that such and such a state of affairs is inconceivable! 128

Page 21

84 The role of a proposition in the calculus is its sense.

It is only in language that something is a proposition. To understand a proposition is to understand a language. 130

Page 21

VII

85 Symbols appear to be of their nature unsatisfied.

A proposition seems to demand that reality be compared with it.

"A proposition like a ruler laid against reality." 132

Page 21

86 If you see the expression of an expectation you see what is being expected.

It looks as if the ultimate thing sought by an order had to remain unexpressed.--As if the sign was trying to communicate with us.

A sign does its job only in a grammatical system. 132

Page 21

87 It seems as if the expectation and the fact satisfying the expectation fitted together somehow. Solids and hollows.--Expectation is not related to its satisfaction in the same way as hunger is related to its satisfaction.

133

Page 21

88 The strange thing that the event I expected isn't distinct from the one I expected.--"The report was not so loud as I had expected."

"How can you say that the red which you see in front of you is the same as the red you imagined?"--One takes the meaning of the word "red" as being the sense of a proposition saying that something is red.

134

Page 21

89 A red patch looks different from one that is not red. But it would be odd to say "a red patch looks different when it is there from when it isn't there". Or: "How do you know that you are expecting a *red* patch?"

135

Page Break 22

Page 22

90 How can I expect the event, when it isn't yet there at all?--I can imagine a stag that is not there, in this meadow, but not kill one that is not there.--It is not the expected thing that is the fulfilment, but rather its coming about. It is difficult for us to shake off this comparison: a man makes his appearance--an event makes its appearance. 136

Page 22

91 A search for a particular thing (e.g. my stick) is a particular kind of search, and differs from a search for something else because of what one does (says, thinks) while searching, not because of what one finds.--Contrast looking for the trisection of the angle. 138

Page 22

92 The symptoms of expectation are not the expression of expectation.

In the sentence "I expect that he is coming" is one using the words "he is coming" in a different sense from the one they have in the assertion "he is coming"?

What makes it the expectation precisely of *him*?

Various definitions of "expecting a person X".

It isn't a later experience that decides *what* we are expecting.

"Let us put the expression of expectation in place of the expectation." 138

Page 22

93 Expectation as preparatory behaviour.

"Expectation is a thought"

If *hunger* is called a wish it is a hypothesis that just that will satisfy the wish.

In "I have been expecting him all day" "expect" does not mean a persistent condition. 140

Page 22

94 When I expect someone,--what happens?

What does the process of wanting to eat an apple consist in? 141

Page Break 23

Page 23

95 Intention and intentionality.--

"The thought that p is the case doesn't presuppose that it is the case; yet I can't think that something is red if

the colour red does not exist." Here we mean the existence of a red sample *as part of our language*.

142

Page 23

96 It's beginning to look somehow as if intention could never be recognized as *intention* from the outside. But the point is that one has to read off from a thought that it is the thought that such and such is the case.

143

Page 23

97 This is connected with the question whether a machine could think. This is like when we say: "The will can't be a phenomenon, for whatever phenomenon you take is something that *simply happens*, not something we *do*." But there's no doubt that you *also* have experiences when you move your arm voluntarily, although the phenomena of doing are indeed different from the phenomena of observing. But there are very different cases here.

144

Page 23

98 The intention seems to interpret, to give the final interpretation.

Imagine an 'abstract' sign-language translated into an unambiguous picture-language. Here there seem to be no further possibilities of interpretation.--We might say we didn't enter into the sign-language but did enter into the painted picture. Examples: picture, cinema, dream.

145

Page 23

99 What happens is not that this symbol cannot be further interpreted, but: I do no interpreting.

I imagine N. No interpretation accompanies this image; what gives the image its interpretation is the *path* on which it lies.

147

Page 23

100 We want to say: "Meaning is essentially a mental process, not a process in dead matter."--What we are dissatisfied with here is the grammar of *process*, not the specific kind of process.

148

Page Break 24

Page 24

101 Doesn't the system of language provide me with a medium in which the proposition is no longer dead?--"Even if the *expression* of the wish is the wish, still the whole language isn't present during this expression." But that is not necessary.

149

Page 24

102 In the gesture we don't see the real shadow of the fulfilment, the unambiguous shadow that admits of no further interpretation.

149

Page 24

103 It's only considering the linguistic manifestation of a wish that makes it appear that my wish prefigures the fulfilment.--Because it's the wish that just that were the case.--It is in language that wish and fulfilment meet.

150

Page 24

104 "A proposition isn't a mere series of sounds, it is something more." Don't I see a sentence as part of a system of consequences?

152

Page 24

105 "This queer thing, thought."--It strikes us as queer when we say that it connects objects in the mind.--We're all ready to pass from it to the reality.--"How was it possible for thought to deal with the very person *himself*?" Here I am being astonished by my own linguistic expression and momentarily misunderstanding it.

154

Page 24

106 "When I think of what will happen tomorrow I am mentally already in the future."--Similarly people think that the *endless series of cardinal numbers* is somehow before our mind's eye, whenever we can use that expression significantly.

A thought experiment is like a drawing of an experiment that is not carried out. 155

Page 24

107 We said "one cannot recognize intention as intention from the outside"--i.e. that it is not something that happens, or happens to us, but something we do. It is almost as if we said: we cannot see ourselves going to a place, because it is we who are doing the going. One does have a particular experience if one is doing the going oneself.

156

Page Break 25

108 Fulfilment of expectation doesn't consist in some third thing's happening, such as a feeling of satisfaction.

157

VIII

109 A description of language must achieve the same result as language itself.

Suppose someone says that one can infer from a proposition [[sic]] the fact that verifies it. What can one infer from a proposition apart from *itself*?

The shadowy anticipation of a fact consists in our being able already to think that *that very thing* will happen which *hasn't yet* happened.

159

110 However many steps I insert between the thought and its application, each intermediate step always follows the previous one without any intermediate link, and so too the application follows the last intermediate step.--We can't cross the bridge to the execution (of an order) until we are there.

160

111 It is the *calculus* of thought that connects with extra-mental reality. From expectation to fulfilment is a step in a calculation.

160

112 We are--as it were--surprised, not at anyone's knowing the future, but at his being able to prophesy at all (right or wrong).

161

IX

113 Is the pictorial character of thought an agreement with reality? In what sense can I say that a proposition is a picture?

163

114 The sense of a proposition and the sense of a picture. The different grammar of the expressions:

"This picture shows people at a village inn."

"This picture shows the coronation of Napoleon."

164

115 A picture's telling me something will consist in my recognizing in it objects in some sort of characteristic arrangement.--

What does "this object is familiar to me" mean?

165

116 "I see what I see." I say that because I don't want to give a name to what I see.--I want to exclude from my consideration of familiarity everything that is 'historical'.--The multiplicity of familiarity is that of feeling at home in what I see.

165

117 Understanding a genre picture: don't we recognize the painted people as people and the painted trees as trees, etc.?

A picture of a human face is a no less familiar object than the human face itself. But there is no question of recognition here.

166

118 The false concept that recognizing always consists in comparing two impressions with one another.--

"We couldn't use words at all if we didn't recognize them and the objects they denote." Have we any sort of check on this recognition?

167

119 This shape I see is not simply a shape, but is one of the shapes I know.--But it is not as if I were comparing the object with a picture set beside it, but as if the object *coincided* with the picture. I see only one thing, not two.

168

120 "This face has a quite *particular* expression." We perhaps look for words and feel that everyday language is here too crude.

169

121 That a picture tells me something consists in its own form and colours. Or it narrates something to me: it uses

words so to speak, and I am comparing the picture with a combination of linguistic forms.--That a series of signs tells me something isn't constituted by its now making this impression on me. "It's only in a language that something is a proposition."
169

Page 27

122 'Language' is languages.--Languages *are* systems.
It is units of languages that I call "propositions".
170

Page 27

123 Certainly, I read a story and don't give a hang about any system of language, any more than if it was a story in pictures. Suppose we were to say at this point "something is a picture only in a picture-language."?
171

Page 27

124 We might imagine a language in whose use the impression made on us by the signs played no part.
What I call a "proposition" is a position in the game of language.
Thinking is an activity, like calculating.
171

Page 27

125 A puzzle picture. What does it amount to to say that after the solution the picture means something to us, whereas it meant nothing before?
172

Page 27

126 The impression is one thing, and the impression's being determinate is another thing. The impression of familiarity is perhaps the characteristics of the determinacy that every strong impression has.
174

Page 27

127 Can I think away the impression of individual familiarity where it exists; and think it into a situation where it does not? The difficulty is not a psychological one. *We* have not *determined* what that is to mean.
Can I look at a printed English word and see it as if I hadn't learnt to read?
I can ascribe meaning to a meaningless shape.
175

Page Break 28

Page 28

128 We can read courage into a face and say "now once more courage *fits* this face". This is related to "an attributive adjective agrees with the subject".
What do I do if I take a smile now as a kind one, now as malicious? This is connected with the contrast between *saying* and *meaning*.
176

Page 28

129 A friendly mouth, friendly eyes, the wagging of a dog's tail are primary symbols of friendliness: they are parts of the phenomena that are called friendliness. If we want to imagine further appearances as expressions of friendliness, we read these symbols into them. It is not that I can imagine that this man's face might change so that it looked courageous, but that there is a quite definite way in which it can change into a courageous face.
Think of the multifariousness of what we call "language": word-language, picture-language, gesture-language, sound-language.
178

Page 28

130 "'This object is familiar to me' is like saying 'this object is portrayed in my catalogue.'" We are making the assumption that the picture in our catalogue is itself familiar.
The sheath in my mind as a "form of imagining".--The pattern is no longer presented as an object, which means that it didn't make sense to talk of a pattern at all.
"Familiarity: an object's fitting into a sheath"--that's not quite the same as our *comparing* what is seen with a copy.
The question is "*What* do I recognize *as what*?" For "to recognize a thing as itself" is meaningless.
179

Page 28

131 The comparison between memory and a notebook.
How did I read off from the memory image that I stood thus at the window *yesterday*? What made you so certain when you spoke those words? Nothing; I *was* certain.
How do I *react* to a memory?
181

Page 28

132 Operating with written signs and operating with "imagination pictures".

An attitude to a picture (to a thought) is what connects it with reality. 182

X

133 Grammatical rules determine a meaning and are not answerable to any meaning that they could contradict. Why don't I call cookery rules arbitrary, and why am I tempted to call the rules of grammar arbitrary? I don't call an argument good just because it has the consequences I want. The rules of grammar are arbitrary in the same sense as the choice of a unit of measurement.

184

134 Doesn't grammar put the primary colours together because there is a kind of similarity between them? Or colours, anyway, in contrast to shapes or notes?

The rules of grammar cannot be justified by shewing that their application makes a representation agree with reality.

The analogy between grammar and games. 185

135 Language considered as a part of a psychological mechanism.

I do not use "this is the sign for sugar" in the same way as the sentence "if I press this button, I get a piece of sugar". 187

136 Suppose we compare grammar to a keyboard which I can use to direct a man by pressing different combinations of keys. What corresponds in this case to the grammar of language?

If the utterance of a 'nonsensical' combination of words has the effect that the other person stares at me, I don't on that account call it the order to stare.

188

137 Language is not defined for us as an arrangement fulfilling a definite purpose. 189

138 Grammar consists of conventions--say in a chart. This might be a part of a mechanism. But it is the connection and not the effect which determines the meaning.

Can one speak of a grammar in the case where a language is taught to a person by a mere drill?

190

139 I do not scruple to *invent* causal connections in the mechanism of language.

To invent a keyboard might mean to invent something that had the desired effect; or else to devise new forms which were similar to the old ones in various ways.

"It is always for living beings that signs exist." 191

140 Inventing a language--inventing an instrument--inventing a game.

If we imagine a goal for chess--say entertainment--then the rules are not arbitrary. So too for the choice of a unit of measurement.

We can't say "without language we couldn't communicate with one another". The concept of language is *contained in* the concept of communication. 192

141 Philosophy is philosophical problems. Their common element extends as far as the common element in different regions of our language.

Something that at first sight looks like a proposition and is not one. Something that looks like a design for a steamroller and is not one. 193

142 Are we willing to call a series of independent signals "a language"?

Imagine a diary kept with signals. Are explanations given so that the signals are connected to another language?

A language consisting of commands. We wouldn't say that a series of such signals alone would enable me to *derive* a picture of the movement of a man obeying them unless in addition to the signal there is something that

might be called a general rule for translating into drawing.

The grammar explains the meaning of the signs and thus makes the language pictorial. 194

Page 31

Appendix

1 Complex and Fact.	199
Page 31	
2 Concept and Object, Property and Substrate.	202
Page 31	
3 Objects.	208
Page 31	
4 Elementary propositions.	210
Page 31	
5 Is time essential to propositions? Comparison between time and truth-functions.	215
Page 31	
6 The nature of hypotheses.	219
Page 31	
7 Probability.	224
Page 31	
8 The concept "about". The problem of the heap.	236

Part II: On Logic and Mathematics

I Logical Inference

Page 31	
1 Is it because we understand the propositions that we know that q entails p? Does a sense give rise to the entailment?	243

Page Break 32

Page 32	
2 "If p follows from q, then thinking that q must involve thinking that p."	247
Page 32	
3 The case of infinitely many propositions following from a single one.	250
Page 32	
4 Can an experience show that one proposition follows from another?	255

II Generality

Page 32	
5 The proposition "The circle is in the square" is in a certain sense independent of the assignment of a particular position. (In a certain sense it is totally unconnected.)	257
Page 32	
6 The proposition "The circle is in the square" is not a disjunction of cases.	261
Page 32	
7 The inadequacy of the Frege-Russell notation for generality.	265
Page 32	
8 Criticism of my former view of generality.	268
Page 32	
9 The explanation of generality by examples.	270
Page 32	
10 The law of a series. "And so on".	280

III The Foundations of Mathematics

11 The comparison between Mathematics and a game.	289
Page 32	
12 There is no metamathematics.	296
Page 32	
13 Proofs of relevance.	299

Page 32
14 Consistency proofs 303

Page Break 33

Page 33
15 Justifying arithmetic and preparing it for its application (Russell, Ramsey). 306

Page 33
16 Ramsey's theory of identity. 315

Page 33
17 The concept of the application of arithmetic (mathematics) 319

Page 33

IV On Cardinal Numbers

18 Kinds of cardinal number 321

Page 33
19 $2 + 2 + 4$. 332

Page 33
20 Statements of number within mathematics. 348

Page 33
21 Sameness of number and sameness of length. 351

Page 33

V Mathematical Proof

22 In other cases, if I am looking for something, then even before it is found I can describe what finding is; not so, if I am looking for the solution of a mathematical problem.

Mathematical expeditions and Polar expeditions. 359

Page 33
23 Proof and the truth and falsehood of mathematical propositions. 366

Page 33
24 If you want to know *what* is proved, look at the proof. 369

Page 33
25 Mathematical problems. Kinds of problems. Search. "Projects" in mathematics. 377

Page 33
26 Euler's Proof. 383

Page Break 34

Page 34
27 The trisection of an angle etc. 387

Page 34
28 Searching and trying. 393

Page 34

VI Inductive Proofs and Periodicity

29 How far is a proof by induction a proof of a *proposition*? 395

Page 34
30 Recursive proof and the concept of proposition. Is the proof a proof that a proposition is true and its contradictory false? 397

Page 34
31 Induction, $(x).\phi x$ and $(\exists x).\phi x$. Does the induction prove the general proposition true and an existential proposition false? 400

Page 34
32 Is there a *further step* from writing the recursive proof to the generalization? Doesn't the recursion schema already say all that is to be said? 405

Page 34
33 How far does a recursive proof deserve the name of "proof". How far is a step in accordance with the paradigm A justified by the proof of B? 408

Page 34

34 The recursive proof does not reduce the number of fundamental laws.	425
Page 34	
35 Recurring decimals $1:3 = 0 \cdot 3$.	427
Page 34	
36 The recursive proof as a series of proofs.	430
Page 34	
37 Seeing or viewing a sign in a particular manner. Discovering an aspect of a mathematical expression. " <i>Seeing</i> an expression in a particular way." Marks of emphasis.	437
Page 34	
38 Proof by induction, arithmetic and algebra.	448

Page Break 35

Page 35

VII Infinity in Mathematics

39 Generality in arithmetic.	451
Page 35	
40 On set theory.	460
Page 35	
41 The extensional conception of the real numbers.	471
Page 35	
42 Kinds of irrational number (π P, F).	475
Page 35	
43 Irregular infinite decimals.	483
Page 35	
Note in Editing.	487
Page 35	
Translator's note.	491

Page Break 36

Page Break 37

Part I: The Proposition and its Sense

Page 37

Page Break 38

Page Break 39

I

Page 39

1 How can one talk about 'understanding' and 'not understanding' a proposition? Surely it is not a proposition until it's understood?

Page 39

Does it make sense to point to a clump of trees and ask "Do you understand what this clump of trees says?" In normal circumstances, no; but couldn't one express a sense by an arrangement of trees? Couldn't it be a code?

Page 39

One would call 'propositions' clumps of trees one understood; others, too, that one didn't understand, provided one supposed the man who planted them had understood them.

Page 39

"Doesn't understanding only start with a proposition, with a whole proposition? Can you *understand* half a proposition?"--Half a proposition is not a whole proposition.--But what the question means can perhaps be understood as follows. Suppose a knight's move in chess was always carried out by two movements of the piece, one straight and one oblique; then it could be said "In chess there are no half knight's moves" meaning: the relationship of half a knight's move to a whole knight's move is not the same as that of half a bread roll to a whole bread roll. We want to say that it is not a difference of degree.

Page 39

It is strange that science and mathematics make use of propositions, but have nothing to say about understanding those propositions.

2 We regard understanding as the essential thing, and signs as something inessential.--But in that case, why have the signs at all? If you think that it is only so as to make ourselves understood by others, then you are very likely looking on the signs as a drug which is to produce in other people the same condition as my own.

Suppose that the question is "what do you mean by that gesture?" and the answer is "I mean you must leave". The answer would not have been more correctly phrased: "I mean what I mean by the sentence 'you must leave'."

In attacking the formalist conception of arithmetic, Frege says more or less this: these petty explanations of the signs are idle once we *understand* the signs. Understanding would be something like seeing a picture from which all the rules followed, or a picture that makes them all clear. But Frege does not seem to see that such a picture would itself be another sign, or a calculus to explain the written one to us.

What we call "understanding a language" is often like the understanding we get of a calculus when we learn its history or its practical application. And there too we meet an easily surveyable symbolism instead of one that is strange to us.--Imagine that someone had originally learnt chess as a writing game, and was later shown the 'interpretation' of chess as a board game.

In this case "to understand" means something like "to take in as a whole".

If I give anyone an order I feel it to be quite enough to give him signs. And if I am given an order, I should never say: "this is only words, and I have got to get behind the words". And when I have asked someone something and he gives me an answer I am content--that was just what I expected--and I don't raise the objection: "but that's a mere answer."

But if you say: "How am I to know what he means, when I see nothing but the signs he gives?" then I say: "How is *he* to know what he means, when he has nothing but the signs either?"

What is spoken can only be explained in language, and so in this sense language itself cannot be explained.

Language must speak for itself.

3 One can say that meaning drops out of language; because what a proposition means is told by yet another proposition.

"What did you mean by those words?" "Did you *mean* those words." The first question is not a more precise specification of the second. The first is answered by a proposition replacing the proposition which wasn't understood. The second question is like: "Did you mean that seriously or as a joke?"

Compare: "Did you mean anything by that gesture--if so what?"

In certain of their applications the words "understand", "mean" refer to a psychological reaction while hearing, reading, uttering etc. a sentence. In that case understanding is the phenomenon that occurs when I hear a sentence in a familiar language and not when I hear a sentence in a strange language.

Learning a language *brings about* the understanding of it. But that belongs to the past history of the reaction.--The understanding of a sentence is as much something that happens to me as is the hearing of a sentence; it accompanies the hearing.

I can speak of 'experiencing' a sentence. "I am not merely saying this, I mean something by it." When we consider what is going on in us when we *mean* (and don't just say) words, it seems to us as if there were something coupled to the words, which otherwise would run idle. As if they *connected* with something in us.

4 Understanding a sentence is more akin to understanding a piece of music than one might think. Why must these bars be played just so? Why do I want to produce just this pattern of variation in loudness and tempo? I would like to say "Because I know what it's all about." But what is it all about? I should not be able to say. For explanation I can only translate the musical picture into a picture in another medium and let the one picture throw light on the other.

The understanding of a sentence can also be compared with what we call understanding a picture. Think of a still-life picture, and imagine that we were unable to see it as a spatial representation and saw only patches and lines on the canvas. We could say in that case "we do not understand the picture". But we say the same thing in a different sense when although we see the picture spatially we do not recognize the spatial objects as familiar things like books, animals and bottles.

Suppose the picture is a genre-picture and the people in it are about an inch long. If I had ever seen real people of that size, I would be able to recognize them in the picture and regard it as a life-size representation of them. In that case my visual experience of the picture would *not* be *the same* as the one I have when I see the picture in the normal way as a representation in miniature, although the illusion of spatial vision is the same in each case.--However, acquaintance with real inch-high people is put forward here only as one possible cause of the visual experience; except for that the experience is independent. Similarly, it may be that only someone who has already seen many real cubes can see a drawn cube spatially; but the description of the spatial visual presentation contains nothing to differentiate a real cube from a painted one.

The different experiences I have when I see a picture first one way and then another are comparable to the experience I have when I read a sentence with understanding and without understanding.

(Recall what it is like when someone reads a sentence with a mistaken intonation which prevents him from understanding it--and then realizes how it is to be read.)

(To see a watch as a watch, i.e. as a dial with hands, is like seeing Orion as a man striding across the sky.)

5 How curious: we should like to explain the understanding of a gesture as a translation into words, and the understanding of words as a translation into gestures.

And indeed we really do explain words by a gesture, and a gesture by words.

On the other hand we say "I understand that gesture" in the same sense as "I understand this theme", "it says something" and what that means is that I have a particular experience as I follow it.

Consider the difference it makes to the understanding of a sentence when a word in it is felt as belonging first with one word and then with another. I might have said: the word is conceived, understood, seen, pronounced as belonging first with one word and then with another.

We can call a 'proposition' that which is conceived first in one way and then in another; we can also mean the various ways of conceiving it. This is a source of confusions.

I read a sentence from the middle of a story: "After he had said this, he left her as he did the day before." Do I understand the sentence?--It's not altogether easy to give an answer. It is an English sentence, and to that extent I understand it. I should know how the sentence might be used, I could invent a context for it. And yet I do not understand it in the sense in which I should understand it if I had read the story. (Compare various language-games: describing a state of affairs, making up a story, etc. What counts as a significant sentence in the several cases?)

Do we *understand* Christian Morgenstern's poems, or Lewis Carroll's poem "Jabberwocky"? In these cases it's very clear that the concept of understanding is a fluid one.

6 A sentence is given me in unfamiliar code together with the key for deciphering it. Then, in a certain sense, everything required for the understanding of the sentence has been given me. And yet if I were asked whether I understood the sentence I should reply "I must first decode it" and only when I had it in front of me decoded as an English sentence, would I say "now I understand it".

If we now raise the question "At what moment of translating into English does understanding begin?" we get a glimpse into the

nature of what is called "understanding".

I say the sentence "I see a black patch there"; but the words are after all arbitrary: so I will replace them one after the other by the first six letters of the alphabet. Now it goes "a b c d e f". But now it is dear that--as one would like to say--I cannot think the sense of the above sentence straight away in the new expression. I might also put it like this: I am not used to saying "a" instead of "I", "b" instead of "see", "c" instead of "a" and so on. I don't mean that I am not used to making an immediate association between the word "I" and the sign "a"; but that I am not used to using "a" in the place of "I".

"To understand a sentence" can mean "to know what the sentence signifies"; i.e. to be able to answer the question "what does this sentence say?"

It is a prevalent notion that we can only imperfectly *exhibit* our understanding; that we can only point to it from afar or come close to it, but never lay our hands on it, and that the ultimate thing can never be said. We say: "Understanding is something *different* from the expression of understanding. *Understanding* cannot be exhibited; it is something inward and spiritual."--Or "Whatever I do to exhibit understanding, whether I repeat an explanation of a word, or carry out an order to show that I have understood it, these bits of behaviour do not *have* to be taken as proofs of understanding." Similarly, people also say "I cannot show anyone else my toothache; I cannot *prove* to anyone else that I have toothache." But the impossibility spoken of here is supposed to be a logical one. "Isn't it the case that the expression of understanding is always an incomplete expression?" That means, I suppose, an expression with something missing--but the something missing is essentially *inexpressible*, because otherwise I

might find a better expression for it. And "essentially inexpressible" means that it makes no sense to talk of a more complete expression.

The psychological processes which are found by experience to accompany sentences are of no interest to us. What does interest us is the understanding that is embodied in an explanation of the sense of the sentence.

7 To understand the grammar of the word "to mean" we must ask ourselves what is the criterion for an expression's being meant *thus*. What should be regarded as a criterion of the meaning?

An answer to the question "How is that meant?" exhibits the relationship between two linguistic expressions. So the question too is a question about that relationship.

The process we call the understanding of a sentence or of a description is sometimes a process of translation from one symbolism into another; tracing a picture, copying something, or translating into another mode of representation.

In that case understanding a description means making oneself a picture of what is described. And the process is more or less like making a drawing to match a description.

We also say: "I understand the picture exactly, I could model it in clay".

8 We speak of the understanding of a sentence as a condition of being able to apply it. We say "I cannot obey an order if I do not understand it" or "I cannot obey it before I understand it".

"Must I really understand a sentence to be able to act on it?--Certainly, otherwise you wouldn't know what you had to do."--But how does this knowing help me? Isn't there in turn a jump from knowing to doing?

Page 45

"But all the same I must understand an order to be able to act according to it"--here the "must" is fishy. If it is a logical must, then the sentence is a grammatical remark.

Page Break 46

Page 46

Here it could be asked: How long before obeying it *must* you understand the order?--But of course the proposition "I must understand the order before I can act on it" makes good sense: but not a metalogical sense.--And 'understanding' and 'meaning' are not metalogical concepts.

Page 46

If "to understand a sentence" means somehow or other to act on it, then understanding cannot be a precondition for our acting on it. But of course experience may show that the specific behaviour of understanding is a precondition for obedience to an order.

Page 46

"I cannot carry out the order because I don't understand what you mean.--Yes, I understand you now."--What went on when I suddenly understood him? Here there are *many* possibilities. For example: the order may have been given in a familiar language but with a wrong emphasis, and the right emphasis suddenly occurred to me. In that case perhaps I should say to a third party: "Now I understand him: he means..." and should repeat the order with the right emphasis. And when I grasped the familiar sentence I'd have understood the order,--I mean, I should not first have had to grasp an abstract sense.--Alternatively: I understood the order in *that* sense, so it was a correct English sentence, but it seemed preposterous. In such a case I would say: "I do not understand you: because you can't mean *that*." But then a more comprehensible interpretation occurred to me. Before I understand several interpretations, several explanations, may pass through my mind, and then I decide on one of them.

Page 46

(Understanding, when an absent-minded man at the order "Right turn!" turns left, and then, clutching his forehead, says "Oh! right turn" and does a right turn.)

Page 46

9 Suppose the order to square a series of numbers is written in the form of a table, thus:

Page Break 47

x	1	2	3
x^2			

Page 47

--It seems to us as if by understanding the order we add something to it, something that fills the gap between command and execution. So that if someone said "You understand it, don't you, so it is not incomplete" we could reply "Yes, I understand it, but only because I add something to it, namely the interpretation."--But what makes you give just *this* interpretation? Is it the order? In that case it was already unambiguous, since it demanded this interpretation. Or did you attach the interpretation arbitrarily? In that case what you understood was not the command, but only what you made of it.

Page 47

(While thinking philosophically we see problems in places where there are none. It is for philosophy to show that there are no problems.)

Page 47

But an interpretation is something that is given in signs. It is *this* interpretation as opposed to a different one (running differently). So if one were to say "Any sentence still stands in need of an interpretation" that would mean: no sentence can be understood without a rider.

Page 47

Of course sometimes I do *interpret* signs, give signs an interpretation; but that does not happen every time I understand a sign. (If someone asks me "What time is it?" there is no inner process of laborious interpretation; I simply react to what I see and hear. If someone whips out a knife at me, I do not say "I interpret that as a threat".)

Page 47

10 "Understanding a word" may mean: *knowing* how it is used; *being able to apply* it.

"Can you lift this ball?"--"Yes". Then I try and fail. Then perhaps I say "I *was wrong*, I cannot". Or perhaps "I can't now, because I am too tired; but when I said I could, I really could." Similarly "I thought I could play chess, but now I have forgotten

how", but on the other hand "When I said 'I can play chess' I really could, but now I've lost it."--But what is the criterion for my being able at that particular time? How did I know that I could? To that question I would answer "I've always been able to lift that sort of weight", "I lifted it just a moment before", "I've played chess quite recently and my memory is good", "I'd just recited the rules" and so on. What I regard as an answer to that question will show me in what way I use the word "can".

Knowing, being able to do something, a capacity is what we would call a *state*. Let us compare with each other propositions which all in various senses describe states.

"I have had toothache since yesterday."
"I have been longing for him since yesterday."
"I have been expecting him since yesterday."
"I have known since yesterday that he is coming."
"Since yesterday I can play chess."

Can one say: "I have known continuously since yesterday that he is coming?" In which of the above sentences can one sensibly insert the word "continuously"?

If knowledge is called a "state" it must be in the sense in which we speak of the state of a body or of a physical model. So it must be in a physiological sense or in the sense used in a psychology that talks about unconscious states of a mind-model. Certainly no one would object to that; but in that case one still has to be clear that we have moved from the grammatical realm of 'conscious states' into a different grammatical realm. I can no doubt speak of unconscious toothache, if the sentence "I have unconscious toothache" means something like "I have a bad tooth that doesn't ache". But the expression "conscious state" (in its old sense) doesn't have the same grammatical relationship to the expression

"unconscious state" as the expression "a chair which I see" has to "a chair which I don't see because it's behind me".

Instead of "to know something" we might say "to keep a piece of paper on which it is written".

If "to understand the meaning of a word" means to know the grammatically possible ways of applying it, then I can ask "How can I know what I mean by a word at the moment I utter it? After all, I can't have the whole mode of application of a word in my head all at once".

I can have the possible ways of applying a word in my head in the same sense as the chess player has all the rules of chess in his head, and the alphabet and the multiplication table. Knowledge is the hypothesized reservoir out of which the visible water flows.

11 So we mustn't think that when we understand or mean a word what happens is an act of instantaneous, as it were non-discursive, grasp of grammar. As if it could all be swallowed down in a single gulp.

It is as if I get tools in the toolbox of language ready for future use.

"I can use the word 'yellow'" is like "I know how to move the king in chess".

In this example of chess we can again observe the ambiguity of the word "understand". When a man who knows the game watches a game of chess, the experience he has when a move is made usually differs from that of someone else watching without understanding the game. (It differs too from that of a man who doesn't even know that it's a game.) We can also say that it's the knowledge of the rules of chess which makes the difference between the two spectators, and so too that it's the knowledge of the

rules which makes the first spectator have the particular experience he has. But this experience is not the knowledge of the rules. Yet we are inclined to call them both "understanding".

The understanding of language, as of a game, seems like a background against which a particular sentence acquires meaning.--But this understanding, the knowledge of the language, isn't a conscious state that accompanies the sentences of the language. Not even if one of its consequences is such a state. It's much more like the understanding or mastery of a calculus, something like the *ability* to multiply.

12 Suppose it were asked: "When do you know how to play chess? All the time? Or just while you say that you can? Or just during a move in the game?"--How queer that knowing how to play chess should take such a short time, and a game of chess so much longer!

(Augustine: "*When* do I measure a period of time?")

It can seem as if the rules of grammar are in a certain sense an unpacking of something we experience all at once when we use a word.

In order to get clearer about the grammar of the word "understand", let's ask: *when* do we understand a sentence?--When we've uttered the whole of it? Or while uttering it?--Is understanding, like the uttering of a sentence, an articulated process and does its articulation correspond exactly to that of the sentence? Or is it non-articulate, something accompanying the sentence in the way a pedal note accompanies a melody?

How long does it take to understand a sentence?

And if we understand a sentence for a whole hour, are we always starting afresh?

13 Chess is characterized by its rules (by the list of rules). If I define the game (distinguish it from draughts) by its rules, then

these rules belong to the grammar of the word "chess". Does that mean that if someone uses the word "chess" intelligently he must have a definition of the word in mind? Certainly not.--He will only give one if he's asked what he means by "chess".

Suppose I now ask: "When you uttered the word, what did you mean by it?"--If he answered "I meant the game we've played so often, etc. etc." I would know that this explanation hadn't been in his mind at all when he used the word, and that he wasn't giving an answer to my question in the sense of telling me what "went on inside him" while he was uttering the word.

When someone interprets, or understands, a sign in one sense or another, what he is doing is taking a step in a calculus (like a calculation). What he does is roughly what he does if he gives expression to his interpretation.

"Thought" sometimes means a particular mental process which may accompany the utterance of a sentence and sometimes the sentence itself in the system of language.

"He said those words, but he didn't think any thoughts with them."--"Yes, I did think a thought while I said them". "*What* thought?" "Just what I said."

On hearing the assertion "This sentence makes sense" you cannot really ask "what sense?" Just as on hearing the assertion "this combination of words is a sentence" you cannot ask "what sentence?"

II

14 Can what the rules of grammar say about a word be described in another way by describing the process which

takes place when understanding occurs?

Page 52

Suppose the grammar is the geometry of negation for example, can I replace it by the description of what "lies behind" the word "not" when it is applied?

Page 52

We say: "Anyone who understands negation knows that two negations yield an affirmation."

Page 52

That sounds like "Carbon and oxygen yield carbonic acid". But in reality a doubled negation does not *yield* anything, it *is* something.

Page 52

Something here gives us the illusion of a fact of physics. As if we saw the result of a logical process. Whereas the only result is the result of the physical process.

Page 52

We would like to say: "Negation has the property that when it is doubled it yields an affirmation," But the rule doesn't give a further description of negation, it constitutes negation.

Page 52

Negation has the property that it denies truly such and such a sentence.

Page 52

Similarly, a circle--say one painted on a flat surface--has the property of being in such and such a position, of having the colour it has, of being bisected by a certain line (a boundary between two colours) and so on; but it doesn't have the properties that geometry seems to ascribe to it (i.e. the *ability* to have the other properties).

Page 52

Likewise one doesn't have the property that when it's added to itself it makes two.

Page 52

15 Geometry no more speaks about cubes than logic does about negation.

Page 52

Geometry defines the form of a cube but does not describe it. If the description of a cube says that it is red and hard, then 'a

Page Break 53

description of the form of a cube' is a sentence like "This box has the form of a cube".

Page 53

But if I describe how to make a cubical box, doesn't this contain a description of the form of a cube? A description only insofar as this thing is said to be cubical, and for the rest an analysis of the concept of cube.

Page 53

"This paper is *not* black, and two such negations yield an affirmation".

Page 53

The second clause is reminiscent of "and two such horses can pull the cart". But it contains no assertion about negation; it is a rule for the replacement of one sign by another.

Page 53

"That two negations yield an affirmation must already be contained in the negation that I am using now." Here I am on the verge of inventing a mythology of symbolism.

Page 53

It looks as if one could *infer* from the meaning of negation that " $\sim\sim p$ " means p . As if the rules for the negation sign *follow from* the nature of negation. So that in a certain sense there is first of all negation, and then the rules of grammar.

Page 53

It also looks as if the essence of negation had a double expression in language: the one whose meaning I grasp when I understand the expression of negation in a sentence, and the consequences of this meaning in the grammar.

Page 53

16 What does it mean to say that the "is" in "The rose is red" has a different meaning from the "is" in "Twice two is four"? If it is answered that it means that different rules are valid for these two words, we can say that we have only *one* word here.--And if all I am attending to is grammatical rules, these do allow the use of the word "is" in both connections.--But the rule which shews that the word "is" has different meanings in the two sentences is the one

Page Break 54

allowing us to replace the word "is" in the second sentence by "equals" and forbidding this substitution in the first sentence.

Page 54

"Is this rule then only the consequence of the *first* rule, that the word 'is' has different meanings in the two sentences? Or is it rather that this very rule is the expression of the word's having a different meaning in the two contexts?"

Page 54

It looks as if a sentence with e.g. the word "ball" in it already contained the shadow of other uses of this word. That is to say, the *possibility* of forming those other sentences. To whom does it look like that? And under what circumstances?

Page 54

The comparison suggests itself that the word "is" in different cases has different *meaning-bodies* behind it; that it is perhaps each time a square surface, but in one case it is the end surface of a prism and in the other the end surface of a pyramid.

Page 54

Imagine the following case. Suppose we have some completely transparent glass cubes which have one face painted red. If we arrange these cubes together in space, only certain arrangements of red squares will be permitted by the shape of the glass bodies. I might then express the rule for the possible arrangements of the red squares without mentioning the cubes; but the rule would none the less contain the essence of the form of cube--Not, of course, the fact that there are glass cubes behind the red squares, but the geometry of the cube.

Page 54

But suppose we *see* such a cube: are we immediately presented with the rules for the possible combinations, i.e. the geometry of the cube? Can I read off the geometry of the cube from a cube?

Page 54

Thus the cube is a notation for the rule. And if we had discovered such a rule, we really wouldn't be able to find anything better than the drawing of a cube to use as a notation for it. (And it is significant that here a drawing of a cube will do instead of a cube.)

Page Break 55

Page 55

But how can the cube (or the drawing) serve as a notation for a geometrical rule? Only if it belongs, as a proposition or part of a proposition, to a system of propositions.

Page 55

17 "Of course the grammatical possibilities of the negation sign reveal themselves bit by bit in the use of the signs, but I *think* negation all at once. The sign 'not' is only a pointer to the thought 'not'; it is only a stimulus to produce the right thought, only a signal."

Page 55

(If I were asked what I mean by the word "and" in the sentence "pass me the bread and butter" I would answer by a gesture of gathering together; and that gesture would illustrate what I mean, in the same way as a green pattern illustrates the meaning of "green" and the T-F notation illustrates the meaning of "not", "and" etc.)

Page 55

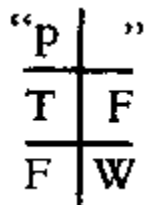

For instance, this sign for negation: is worth no more and no less than any other negation sign; it is a complex of lines just like the expression "not-p" and it is only made into a sign for negation by the way it *works*--I mean, the way it is used in the game.

Page 55

(The same goes for the T-F schemata for tautology and contradiction.)

Page 55

What I want to say is that to be a sign a thing must be dynamic, not static.

Page 55

18 Here it can easily seem as if the sign contained the whole of the grammar; as if the grammar were contained in the sign like a string of pearls in a box and he had only to pull it out. (But this kind of picture is just what is misleading us). As if understanding were an instantaneous grasping of something from which later we only draw consequences which already exist in an ideal sense before they are drawn. As if the cube already contained the geometry of the

cube, and I had only to unpack it. But which cube? Or is there

Page Break 56

an ideal geometrical cube?--Often we have in mind the process of deriving geometrical propositions from a drawing, a representation (or a model). But what is the role of the model in such a case? It has the role of a sign, a sign employed in a particular game.--And it is an interesting and remarkable thing how this sign is employed, how we perhaps use the drawing of a cube again and again in different contexts.--And it is this sign, (*which has the identity proper to a sign*) that we take to be the cube in which the geometrical laws are already laid up. (They are no more laid up there than the disposition to be used in a certain way is laid up in the chessman which is the king).

Page 56

In philosophy one is constantly tempted to invent a mythology of symbolism or of psychology, instead of simply saying what we know.

Page 56

19 The concept of meaning I adopted in my philosophical discussions originates in a primitive philosophy of language.

Page 56

The German word for "meaning" is derived from the German word for "pointing".

Page 56

When Augustine talks about the learning of language he talks about how we attach names to things, or understand the names of things. *Naming* here appears as the foundation, the be all and end all of language.

Page 56

Augustine does not speak of there being any difference between parts of speech and means by "names" apparently words like "tree", "table", "bread" and of course, the proper names of people; also no doubt "eat", "go", "here", "there"--all words, in fact. Certainly he's thinking first and foremost of *nouns*, and of the remaining words as something that will take care of itself. (Plato too says that a sentence consists of nouns and verbs.)†1

Page Break 57

Page 57

They describe the game as simpler than it is.

Page 57

But the game Augustine describes is certainly a part of language. Imagine I want to put up a building using building stones someone else is to pass me; we might first make a convention by my pointing to a building stone and saying "that is a pillar", and to another and saying "that is called 'a block' ", "that is called 'a slab'" and so on. And then I call out the words "pillar", "slab", etc. in the order in which I need the stones.

Page 57

Augustine does describe a calculus of our language, only not everything that we call language is this calculus. (And one has to say this in many cases where we are faced with the question "Is this an appropriate description or not?" The answer is: "Yes, it is appropriate, but only *here*, and not for the whole region that you were claiming to describe.") So it could be said that Augustine represents the matter too simply; but also that he represents something simpler.

Page 57

It is as if someone were to say "a game consists in moving objects about on a surface according to certain rules..." and we replied: You must be thinking of board games, and your description is indeed applicable to them. But they are not the only games. So you can make your definitions correct by expressly restricting it to those games.

Page 57

20 The way Augustine describes the learning of language can show us the way of looking at language from which the concept of the meaning of words derives.

Page 57

The case of our language could be compared with a script in which the letters were used to stand for sounds, and also as signs of emphasis and perhaps as marks of punctuation. If one conceives this script as a language for describing sound-patterns, one can imagine someone misinterpreting the script as if there were simply a correspondence of letters to sounds and as if the letters had not also completely different functions.

Page Break 58

Page 58

Just as the handles in the cabin of a locomotive have different kinds of job, so do the words of language,

which in one way are like handles. One is the handle of a crank, it can be moved continuously since it operates a valve; another works a switch, which has two positions; a third is the handle of a pump and only works when it is being moved up and down etc. But they all look alike, since they are all worked by hand.

Page 58

A connected point: it is possible to speak perfectly intelligibly of *combinations of colours and shapes* (e.g. of the colours red and blue and the shapes square and circle) just as we speak of combinations of different shapes or spatial objects. And this is the origin of the bad expression: a fact is a complex of objects. Here the fact that a man is sick is compared with a combination of two things, one of them the man and the other the sickness.

Page 58

21 A man who reads a sentence in a familiar language experiences the different parts of speech in quite different ways. (Think of the comparison with meaning-bodies.) We quite forget that the written and spoken words "not", "table" and "green" are similar to each other. It is only in a foreign language that we see clearly the uniformity of words. (Compare William James on the feelings that correspond to words like "not", "but" and so on.)

Page 58

("Not" makes a gesture of rejection.

Page 58

No, it *is* a gesture of rejection. To grasp negation is to understand a gesture of rejection.)

Page 58

Compare the different parts of speech in a sentence with lines on a map with different functions (frontiers, roads, meridians, contours.) An uninstructed person sees a mass of lines and does not know the variety of their meanings.

Page Break 59

Page 59

Think of a line on a map crossing a sign out to show that it is void

Page 59

The difference between parts of speech is comparable to the differences between chessmen, but also to the even greater difference between a chessman and the chess board.

Page 59

22 We say: the essential thing in a word is its *meaning*. We can replace the word by another with the same meaning. That fixes a place for the word, and we can substitute one word for another provided we put it in the same place.

Page 59

If I decide to say a new word instead of "red" (perhaps only in thought), how would it come out that it took the place of the word "red"?

Page 59

Suppose it was agreed to say "non" in English instead of "not", and "not" instead of "red". In that case the word "not" would remain in the language, and one could say that "non" was now used in the way in which "not" used to be, and that "not" now had a *different* use.

Page 59

Would it not be similar if I decided to alter the shape of the chess pieces, or to use a knight-shaped piece as the king? How would it be clear that the knight is the king? In this case can't I very well talk about a change of meaning?

Page 59

23 I want to say the place of a word in grammar is its meaning.

Page 59

But I might also say: the meaning of a word is what the explanation of its meaning explains.

Page 59

"What 1 c.c. of water weighs is called '1 gram'--Well, what *does* it weigh?"

Page 59

The explanation of the meaning explains the use of the word.

Page Break 60

Page 60

The use of a word in the language is its meaning.

Page 60

Grammar describes the use of words in the language.

Page 60

So it has somewhat the same relation to the language as the description of a game, the rules of a game, have to the game.

Page 60

Meaning, in our sense, is embodied in the explanation of meaning. If, on the other hand, by the word "meaning" we mean a characteristic sensation connected with the use of a word, then the relation between the explanation of a word and its meaning is rather that of cause to effect.

Page 60

24 An explanation of meaning can remove every *disagreement* with regard to a meaning. It can clear up misunderstandings.

Page 60

The understanding here spoken of is a correlate of explanation.

Page 60

By "explanation of the meaning of a sign" we mean rules for use but above all *definitions*. The distinction between verbal definitions and ostensive definitions gives a rough division of these types of explanation.

Page 60

In order to understand the role of a definition in the calculus we must investigate the particular case.

Page 60

It may seem to us as if the other grammatical rules for a word had to follow from its ostensive definition; since after all an ostensive definition, e.g. "that is called 'red'" determines the meaning of the word "red".

Page 60

But this definition is only those words plus pointing to a red object, e.g. a red piece of paper. And is this definition really unambiguous? Couldn't I have used the very same one to give the word "red" the meaning of the word "paper", or "square", or "shiny", or "light", or "thin" etc. etc.?

Page 60

However, suppose that instead of saying "that is called 'red'"

Page 60

Page Break 61

I had phrased my definition "that colour is called 'red'". That certainly is unambiguous, but only because the expression "colour" settles the grammar of the word "red" up to this last point. (But here questions could arise like "do you call just *this* shade of colour red, or also other similar shades?"). Definitions might be given like this: the colour of this patch is called "red", its shape "ellipse".

Page 61

I might say: one must already understand a great deal of a language in order to understand that definition. Someone who understands that definition must already know where the words ("red", "ellipse") are being put, where they belong in language.

Page 61

25 The words "shape" and "colour" in the definitions determine the *kind of use* of the word, and therefore what one may call the *part of speech*. And in ordinary grammar one might well distinguish "shape words", "colour words", "sound words", "substance words" and so on as different parts of speech. (There wouldn't be the same reason for distinguishing "metal words", "poison words", "predator words". It makes sense to say "iron is a metal", "phosphorus is a poison", etc. but not "red is a colour", "a circle is a shape" and so on.)

Page 61

I can ostensively define a word for a colour or a shape or a number, etc. etc. (children are given ostensive explanations of numerals and they do perfectly well); negation, too, disjunction and so on. The *same* ostension might define a numeral, or the name of a shape or the name of a colour. But in the grammar of each different part of speech the ostensive definition has a different role; and in each case it is only *one* rule.

Page 61

(Consider also the grammar of definitions like: "today is called Monday", "I will call this day of the year 'the day of atonement'").

Page 61

26 But when we learn the meaning of a word, we are very often given *only* the single rule, the ostensive definition. So how does it

Page Break 62

come about that on the strength of this definition we understand the word? Do we guess the rest of the rules?

Page 62

Think also of teaching a child to understand words by showing it objects and uttering words. The child is

given ostensive definitions and then it understands the words.--But what is the criterion of understanding here? Surely, that the child applies the words correctly. Does it guess rules?--Indeed we must ask ourselves whether we are to call these signs and utterances of words "definitions" at all. The language game is still very simple and the ostensive definition has not the same role in this language-game as in more developed ones. (For instance, the child cannot yet ask "What is that called?") But there is no sharp boundary between primitive forms and more complicated ones. I wouldn't know what I can and what I can't still call "definition". I can only describe language games or calculi; whether we still want to call them calculi or not doesn't matter as long as we don't let the use of the general term divert us from examining each particular case we wish to decide.

Page 62

I might also say of a little child "he can use the word, he knows how it is applied." But I only see what that means if I ask "what is the criterion for this knowledge?" In this case it isn't the ability to state rules.

Page 62

What's the sign of someone's understanding a game? Must he be able to recite the rules? Isn't it also a criterion that he can play the game, i.e. that he does in fact play it, even if he's baffled when asked for the rules? Is it only by being told the rules that the game is learnt and not also simply by watching it being played? Of course a man will often say to himself while watching "oh, so that's the rule"; and he might perhaps write down the rules as he observes them; but there's certainly such a thing as learning the game without explicit rules.

Page 62

The grammar of a language isn't recorded and doesn't come into existence until the language has already been spoken by human

Page Break 63

beings for a *long* time. Similarly, primitive games are played without their rules being codified, and even without a single rule being formulated.

Page 63

But we look at games and language under the guise of a game played according to rules. That is, we are always *comparing* language with a procedure of that kind.

Page 63

27 The names I give to bodies, shapes, colours, lengths have different grammars in each case. ("A" in "A is yellow" has one grammar if A is a body and another if A is the surface of a body; for instance it makes sense to say that the body is yellow all through, but not to say that the surface is.) And one points in different sense to a body, and to its length or its colour; for example, a possible definition would be: "to point to a colour" means, to point to the body which has the colour. Just as a man who marries money doesn't marry it in the same sense as he marries the woman who owns the money.

Page 63

Money, and what one buys with it. Sometimes a material object, sometimes the right to a seat in the theatre, or a title, or fast travel, or life, etc.

Page 63

A name has meaning, a proposition has sense in the calculus to which it belongs. The calculus is as it were autonomous.--Language must speak for itself.

Page 63

I might say: the only thing that is of interest to me is the *content* of a proposition and the content of a proposition is something internal to it. A proposition has its content as part of a calculus.

Page 63

The meaning is the role of the word in the calculus.

Page 63

The meaning of a name is not the thing we point to when we give an ostensive definition of the name; that is, it is not the bearer of

Page Break 64

the name.--The expression "the bearer of the name 'N'" is synonymous with the name "N". The expression can be used in place of the name. "The bearer of the name 'N' is sick" means "N is sick". We don't say: The meaning of "N" is sick.

Page 64

The name doesn't lose its meaning if its bearer ceases to exist (if he dies, say).

Page 64

But doesn't "Two names have a single bearer" mean the same as "two names have the same meaning?"

Certainly, instead of "A = B" one can write "the bearer of the name 'A' = the bearer of the name 'B'".

Page 64

28 What does "to understand a word" mean?

Page 64

We say to a child "No, no more sugar" and take it away from him. Thus he learns the meaning of the word "no". If, while saying the same words, we had given him a piece of sugar he would have learnt to understand the word differently. (In this way he has learnt to use the word, but also to associate a particular feeling with it, to experience it in a particular way.)

Page 64

What constitutes the meaning of a word like "perhaps"? How does a child learn the use of the word "perhaps"? It may repeat a sentence it has heard from an adult like "*perhaps* she will come"; it may do so in the same tone of voice as the adult. (That is a kind of a game). In such a case the question is sometimes asked: Does it already understand the word "perhaps" or is it only repeating it?--What shows that it really understands the word?--Well, that it uses it in particular circumstances in a particular manner--in certain contexts and with a particular intonation.

Page 64

What does it mean "to understand the word 'perhaps'"?--Do *I* understand the word "perhaps"?--And how do I judge whether I do? Well, something like this: I know how it's used, I can explain its use to somebody, say by describing it in made-up cases. I can describe the occasions of its use, its position in sentences, the intonation it has in speech.--Of course this only means that "I

Page Break 65

understand the word 'perhaps'" comes to the same as: "I know how it is used etc."; not that I try to call to mind its entire application in order to answer the question whether I understand the word. More likely I would react to this question immediately with the answer "yes", perhaps after having said the word to myself once again, and as it were convinced myself that it's familiar, or else I might think of a single application and pronounce the word with the correct intonation and a gesture of uncertainty. And so on.

Page 65

This is like the case in which someone is explaining to me a calculation "that I don't quite understand", and when he has reached a particular point of his explanation, I say: "ah, now I understand; now I know how to go on". How do I know that I know how to go on? Have I run through the rest of the calculation at that moment? Of course not. Perhaps a bit of it flashed before my mind; perhaps a particular application or a diagram. If I were asked: how do you know that you can use the word "perhaps" I would perhaps simply answer "I have used it a hundred times".

Page 65

29 But it might be asked: Do I *understand* the word just by describing its application? Do I understand its point? Haven't I deluded myself about something important?

Page 65

At present, say, I know only how men use this word. But it might be a game, or a form of etiquette. I do not know why they behave in this way, how *language* meshes with their life.

Page 65

Is meaning then really only the use of a word? Isn't it the way this use meshes with our life?

Page 65

But isn't its use a part of our life?

Page 65

Do I understand the word "fine" when I know how and on what occasions people use it? Is that enough to enable me to use it myself? I mean, so to say, use it with conviction.

Page 65

Wouldn't it be possible for me to know the use of the word and yet follow it without understanding? (As, in a sense, we follow the

Page Break 66

singing of birds). So isn't it something else that constitutes understanding--the feeling "in one's own breast", the living experience of the expressions?--They must mesh with *my own* life.

Page 66

Well, language does connect up with my own life. And what is called "language" is something made up of heterogeneous elements and the way it meshes with life is infinitely various.

Page 66

30 We may say that the words "fine", "oh", and also "perhaps" are *expressions* of sensation, of feeling. But I don't call the feeling the meaning of the word. We are not interested in the relation of the words to the sensation [[sic]], whatever it may be, whether they are evoked by it, or are regularly accompanied by it, or give it an outlet. We are not interested in any empirical facts about language, considered as empirical facts. We are only concerned with the description of what happens and it is not the truth but the form of the description that interests us. What happens considered as a game.

Page 66

I am only *describing* language, not *explaining* anything.

Page 66

For my purposes I could replace the sensation the word is said to express by the intonation and gestures with which the word is used.

Page 66

I might say: in many cases understanding a word involves being able to use it on certain occasions in a special tone of voice.

Page 66

You might say that certain words are only pegs to hang intonations on.

Page 66

But instead of the intonation and the accompanying gestures, I might for my own purposes treat the word itself as a gesture. (Can't I say that the sound "ha ha" is a laugh and the sound "oh!" is a sigh?)

Page Break 67

Page 67

31 I could imagine a language that was spoken in a uniform metre, with quasi-words intercalated between the words of the sentences to maintain the metre. Suppose we talked about the meaning of these quasi-words. (The smith putting in extra taps between the real strokes in order to maintain a rhythm in striking).

Page 67

Language is like a collection of very various tools. In the tool box there is a hammer, a saw, a rule, a lead, a glue pot and glue. Many of the tools are akin to each other in form and use, and the tools can be roughly divided into groups according to their relationships; but the boundaries between these groups will often be more or less arbitrary and there are various types of relationship that cut across one another.

Page 67

I said that the meaning of a word is its role in the calculus of language. (I compared it to a piece in chess). Now let us think how we calculate with a word, for instance with the word "red". We are told where the colour is situated; we are told the shape and size of the coloured patch or the coloured object; we are told whether the colour is pure or mixed, light or dark, whether it remains constant or changes, etc. etc. Conclusions are drawn from the propositions, they are translated into diagrams and into behaviour, there is drawing, measurement and calculation. But think of the meaning of the word "oh!" If we were asked about it, we would say "'oh!' is a sigh; we say, for instance, things like 'Oh, it is raining again already'". And that would describe the use of the word. But what corresponds now to the calculus, the complicated game that we play with other words? In the use of the words "oh!", or "hurrah", or "hm", there is nothing comparable.

Page 67

Moreover, we mustn't confuse signs with symptoms here. The sound "hm" may be called an expression of dubiousness and also, for other people, a *symptom* of dubiousness, in the way that

Page Break 68

clouds are a symptom of rain. But "hm" is not the *name* of dubiousness.

Page 68

32 Suppose we want to describe *ball-games*. There are some games like football, cricket and tennis, which have a well-developed and complicated system of rules; there is a game consisting simply of everyone's throwing a ball as high as he can; and there is the game little children play of throwing a ball in any direction and then retrieving it. Or again someone throws a ball high into the air for the fun of it and catches it again without any element of competition. Perhaps one will be unwilling to call some of these ball games at all; but is it clear where the boundary is to be drawn here?

Page 68

We are interested in language as a procedure according to explicit rules, because philosophical problems are misunderstandings which must be removed by clarification of the rules according to which we are inclined to use words.

We consider language from one point of view only.

We said that when we understood the use we didn't yet understand the *purpose* of the word "perhaps". And by "purpose" in this case we meant the role in human life. (This role can be called the "meaning" of the word in the sense in which one speaks of the 'meaning of an event for our life'.)

But we said that by "meaning" we meant what an explanation of meaning explains. And an explanation of meaning is not an empirical proposition and not a causal explanation, but a rule, a convention.

It might be said that the purpose of the word "hey!" in our language is to alarm the person spoken to. But what does its having this purpose amount to? What is the criterion for it? The word "purpose" like all the words of our language is used in various more or less related ways. I will mention two characteristic games. We might say that the purpose of doing something is what the person doing it would say if asked what its purpose was. On the

other hand if we say that the hen clucks in order to call her chicks together we infer this purpose from the *effect* of the clucking. We wouldn't call the gathering of the chicks the purpose of the clucking if the clucking didn't have this result always, or at least commonly or in specifiable circumstances.--One may now say that the purpose, the effect of the word "hey" is the important thing about the word; but explaining the purpose or the effect is not what we call explaining the meaning.

It may be that if it is to achieve its effect a particular word cannot be replaced by any other; just as it may be that a gesture cannot be replaced by any other. (The word has a *soul* and not just a meaning.) No one would believe that a poem remained *essentially unaltered* if its words were replaced by others in accordance with an appropriate convention.

Our proposition "meaning is what an explanation of meaning explains" could also be interpreted in the following way: let's only bother about what's called the explanation of meaning, and let's not bother about meaning in any other sense.

33 But one might say something like this. The sentences that we utter have a particular purpose, they are to produce certain effects. They are parts of a mechanism, perhaps a psychological mechanism, and the words of the sentences are also parts of the mechanism (levers, cogwheels and so on). The example that seems to illustrate what we're thinking of here is an automatic music player, a pianola. It contains a roll, rollers, etc., on which the piece of music is written in some kind of notation (the position of holes, pegs and so on). It's as if these written signs gave orders which are carried out by the keys and hammers. And so shouldn't we say that the sense of the sign is its effect?--But suppose the pianola is in bad condition and the signs on the roll produce hisses and bangs instead of the notes.--Perhaps you will say that the sense of the signs is their effect on a mechanism in good condition, and correspondingly

that the sense of an order is its effect on an obedient man. But what is regarded as a criterion of obedience here?

You might then say that the sense of the signs is not their effect, but their purpose. But consider too, that we're tempted to think that this purpose is only a part of the larger purpose served by the pianola.--This purpose, say, is to entertain people. But it's clear that when we spoke of "the sense of the signs" we didn't mean any part of *that* purpose. We were thinking rather of the purpose of the signs *within* the mechanism of the pianola.--And so you can say that the purpose of an order is its sense, only so far as the purpose can be expressed by a rule of language. "I am saying 'go away' because I want you to leave me alone", "I am saying 'perhaps' because I am not quite sure."

An explanation of the operation of language as a psychophysical mechanism is of no interest to us. Such an explanation itself uses language to describe phenomena (association, memory etc); it is itself a linguistic act and stands outside the calculus; but we need an explanation which is *part of the calculus*.

"How is he to know what colour he is to pick out when he hears the word 'red'?--Very simple: he is to take

the colour whose image occurs to him when he hears the word"--But how will he know what that means, and which colour it is "which occurs to him when he hears the word"?

Page 70

Certainly there is such a procedure as choosing the colour which occurs to you when you hear that word. And the sentence "red is the colour that occurs to you when you hear the word 'red'" is a definition.

Page 70

If I say, "a symbol is something which produces this effect" the question remains: how can I speak of "this effect"? And if it occurs, how do I know that it's *the one I meant*?" "Very simple", we may say "we compare it with our memory image." But this explanation does not get to the root of our dissatisfaction. For

Page Break 71

how are we given the method we're to use in making the comparison--i.e. how do we know what we're to do when we're told to compare?

Page 71

In our language one of the functions of the word "red" is to call that particular colour to mind; and indeed it might be discovered that this word did so better than others, even that it alone served that purpose. But instead of the mechanism of association we might also have used a colour chart or some such apparatus; and then our calculus would have to get along with the associated, or visible, colour sample. The psychological effectiveness of a sign does not concern us. I wouldn't even scruple to invent that kind of mechanism.

Page 71

Investigating whether the meaning of a word is its effect or its purpose, etc. is a grammatical investigation.

Page 71

34 Why can one understand a word and not a penholder? Is it the difference between their shapes? But you will say that we could understand a penholder too, if we had given it a meaning. But then how is giving it a meaning done?--How was meaning given to the word "red"? Well, you point at something, and you say "I call that 'red'". Is that a kind of consecration of mystical formula? How does this pointing and uttering words work? It works only as part of a system containing other bits of linguistic behaviour. And so now one can understand a penholder too; but does this understanding contain the whole system of its application? Impossible. We say that we understand its meaning when we know its use, but we've also said that the word "know" doesn't denote a state of consciousness. That is: the grammar of the word "know" isn't the grammar of a "state of consciousness", but something different. And there is only one way to learn it: to watch how the word is used in practice.

Page 71

A truthful answer to the question "Did you understand the

Page Break 72

sentence (that you have just read)" is sometimes "yes" and sometimes "no". "So something different must take place when I understand it and when I don't understand it."

Page 72

Right. So when I understand a sentence something happens like being able to follow a melody as a melody, unlike the case when it's so long or so developed that I have to say "I can't follow this bit". And the same thing might happen with a picture, and here I mean an ornament. First of all I see only a maze of lines; then they group themselves for me into well-known and accustomed forms and I see a plan, a familiar system. If the ornamentation contains representations of well-known objects the recognition of these will indicate a further stage of understanding. (Think in this connection of the solution of a puzzle picture.) I then say "Yes, now I see the picture rightly".

Page 72

Asked "what happened when you read that sentence with understanding" I would have to say "I read it as a group of English words linked in a familiar way". I might also say that a picture came into my mind when I heard it. But then I am asked: "Is that all? After all, the understanding couldn't consist in that and nothing else!" Well, that or something like it is all that happened while I read the sentence and immediately afterwards; but what we call "understanding" is related to countless things that happen before and after the reading of *this* sentence.

Page 72

What of when I don't understand a sentence? Well, it might be a sentence in a foreign language and all I see is a row of unknown words. Or what I read seemed to be an English sentence, but it contained an unfamiliar phrase and when I tried to grasp it (and that again can mean various things) I didn't succeed. (Think of what goes on when we try to understand the sense of a poem in our native language which makes use of constructions we don't yet understand.)

But I can say that I understand a sentence in a foreign language

say a Latin one that I can only decipher by a painful effort to construe--even if I have only turned it into English bit by bit and have never succeeded in grasping the overall phrasing of the sentence.

But all the same, in order to understand a sentence I have to understand the words in it! And when I read, I understand some words and not others.

I hear a word and someone asks me "did you understand it?" and I reply truly "yes". What happened when I understood? How was the understanding different from what happens when I don't understand a word?--Suppose the word was "tree". If I am to say truly that I understood it, must the image of a tree have come before my mind? No; nor must any other image. All I can say is that when I was asked "do you understand the word tree?" I'd have answered "yes" unthinkingly and without lying.--If the other person had asked me further "and what is a tree?" I would have described one for him, or shown him one, or drawn one; or perhaps I would have answered "I know, but I don't want to explain." And it may be that when I gave my reply the image of a tree came before my mind, or perhaps I looked for something which had some similarity with a tree, or perhaps other words came into my head, etc. etc.

Let's just look how we actually use the word "understand".

The word might also have been one of which I would say "I used to know what it meant, and it will come back to me", and then later on say "now it's come back to me". What happened then?--Perhaps there came into my mind the situation in which the word was first explained to me: I saw myself in a room with others, etc. etc. (But if now I read and understand the word in a sentence that picture wouldn't have to come before my mind; perhaps no picture at all comes to mind.)

Or it was a word in a foreign language; and I had already often heard it, but never understood it. Perhaps I said to myself "what can it mean?" and tried to give it a meaning which fitted the context

(again various possibilities). Perhaps now this situation comes to mind and I say "I don't understand the word". But I might also react immediately to the foreign word with the answer "I don't understand it", just as I reacted to the word "tree" with the opposite answer.

Suppose it is the word "red" and I say automatically that I understood it; then he asks again "do you really understand it?" Then I summon up a red image in my mind as a kind of check. But how do I know that it's the right colour that appears to me? And yet I say now with full conviction that I understand it.--But I might also look at a colour chart with the word "red" written beneath the colour.--I could carry on for ever describing such processes.

35 The problem that concerns us could be summed up roughly thus: "Must one see an image of the colour blue in one's mind whenever one reads the word 'blue' with understanding?" People have often asked this question and have commonly answered no; they have concluded from this answer that the characteristic process of understanding is just a different process which we've not yet grasped.--Suppose then by "understanding" we mean what makes the difference between reading with understanding and reading without understanding; what *does* happen when we understand? Well, "Understanding" is not the name of a single process accompanying reading or hearing, but of more or less interrelated processes against a background, or in a context, of facts of a particular kind, viz. the actual use of a learnt language or languages.--We say that understanding is a "psychological process", and this label is misleading, in this as in countless other cases. It compares understanding to a particular *process* like translation from one language into another, and it suggests the same conception of thinking, knowing, wishing, intending, etc. That is to say, in all these cases we see that what we would perhaps naively suggest as the hallmark of such a process is not present in

every case or even in the majority of cases. And our next step is to conclude that the essence of the process is something difficult to grasp that still awaits discovery. For we say: since I use the word "understand" in all these

cases, there must be some one thing which happens in every case and which is the essence of understanding (expecting, wishing etc.). Otherwise, why should I call them by all the same name?

Page 75

This argument is based on the notion that what is needed to justify characterizing a number of processes or objects by a general concept-word is something common to them all.

Page 75

This notion is, in a way, *too primitive*. What a concept-word indicates is certainly a kinship between objects, but this kinship need not be the sharing of a common property or a constituent. It may connect the objects like the links of a chain, so that one is linked to another *by intermediary links*. Two neighbouring members may have common features and be *similar* to each other, while distant ones belong to the same family without any longer having anything in common. Indeed even if a feature is common to all members of the family it need not be that feature that defines the concept.

Page 75

The relationship between the members of a concept may be set up by the sharing of features which show up in the family of the concept, crossing and overlapping in very complicated ways.

Page 75

Thus there is probably no single characteristic which is common to all the things we call games. But it can't be said either that "game" just has several independent meanings (rather like the word "bank"). What we call "games" are procedures interrelated in various ways with many different transitions between one and another.

Page 75

It might be said that the use of the concept-word or common noun is justified in this case because there are transitional steps

Page Break 76

between the members.--Then it might be objected that a transition can be made from anything to anything, and so the concept isn't bounded. To this I have to say that for the most part it isn't in fact bounded and the way to specify it is perhaps: "by 'knowledge' we mean these processes, and these, *and similar ones*". And instead of "and similar ones" I might have said "and others akin to these in many ways".

Page 76

But if we wish to draw boundaries in the use of a word, in order to clear up philosophical paradoxes, then alongside the actual picture of the use (in which as it were the different colours flow into one another without sharp boundaries) we may put another picture which is in certain ways like the first but is built up of colours with clear boundaries between them.

Page Break 77

III

Page 77

36 If we look at the actual use of a word, what we see is something constantly fluctuating.

Page 77

In our investigations we set over against this fluctuation something more fixed, just as one paints a stationary picture of the constantly altering face of the landscape.

Page 77

When we study language we *envisage* it as a game with fixed rules. We compare it with, and measure it against, a game of that kind.

Page 77

If for our purposes we wish to regulate the use of a word by definite rules, then alongside its fluctuating use we set up a different use by codifying one of its characteristic aspects.

Page 77

Thus it could be said that the use of the word "good" (in an ethical sense) is a combination of a very large number of interrelated games, each of them as it were a facet of the use. What makes a single concept here is precisely the connection, the relationship, between these facets.

Page 77

But this isn't like the way physics gives a simplified description of a natural phenomenon, abstracting from secondary factors. It can't be said that logic depicts an idealised reality, or that it holds strictly only for an ideal language and so on. For where do we get the concept of this ideal? The most that could be said is that we are *constructing* an ideal language which contrasts with ordinary language; but it can't be said that we are *saying* something that would hold only of an ideal language.

37 There is something else I would like to say about the understanding of a picture. Take a genre-picture: we say we understand

it if we recognise what is happening in it, what the people in it are doing. Here the criterion for this recognition is perhaps that if asked what they are doing we explain it in words or represent it in mime etc. It's possible that this recognition doesn't come easily, perhaps because we don't immediately see the figures in the picture as figures (as in puzzle pictures), perhaps because we can't make out what they are doing together, etc. In these cases there may be a period of doubt followed by a familiar process of recognition. On the other hand, it may be the kind of picture we'd say we took in at first glance, and in that case we find it difficult to say what the understanding really consists of. In the first place what happened was not that we took the painted objects for real ones. And again "I understand it" in this case doesn't mean that finally, after an effort, I understand that it is *this* picture. And nothing takes place like recognizing an old acquaintance in the street, no saying "oh, there's... ". If you insist on saying there is a recognition, what does this recognition consist of? Perhaps I recognize a certain part of the picture as a human face. Do I have to look at a real face, or call before my mind's eye the memory of a face I've seen before? Is what happens that I rummage in the cupboard of my memory until I find something which resembles the picture? Is the recognition just this finding? In our case there is no one thing that happens that could be called recognition, and yet if the person who sees the picture is asked "do you recognize what it is?" he may truly answer "yes", or perhaps reply "it is a face". It can indeed be said that when he sees the complex of signs as a face he sees something different from when he doesn't do so. In that case I'd like to say that I see something *familiar*†1 in front of me. But what constitutes the familiarity is not the historical fact that I've often seen objects like that etc; because the history behind the experience is certainly not present in the experience itself. Rather, the familiarity

lies in the fact that I immediately grasp a particular rhythm of the picture and stay with it, feel at home with it, so to speak. For the rest it is a different experience that constitutes the familiarity in each particular case; a picture of a table carries one experience with it and a picture of a bed another.

If I say: "I understand this picture" the question arises: do I mean "I understand it *like that*"? With the "*like that*" standing for a translation of what I understand into a different expression? Or is it a sort of intransitive understanding? When I'm understanding one thing do I as it were think of another thing? Does understanding, that is, consist of thinking of something else? And if that isn't what I mean, then what's understood is as it were autonomous, and the understanding of it is comparable to the understanding of a melody.

(It is interesting to observe that the pictures which come before our minds when we read an isolated word and try to understand it correctly just like that are commonly altogether absent when we read a sentence; the picture that comes before our minds when we read a sentence with understanding is often something like a resultant of the whole sentence).

38 It is possible for a person to forget the meaning of a word (e.g. "blue"). What has he forgotten?--How is that manifested?

He may point, for instance, to a chart of different colours and say "I don't know any longer which of these is called 'blue'". Or again, he may not any longer know at all what the word means (what purpose it serves); he may know only that it is an English word.

We might say: if someone has forgotten the meaning of the word "blue" and is asked to choose a blue object from among others he feels as he looks at the objects that the connection between the word "blue" and the colour no longer holds but has been broken off. The connection will be reestablished, it might be said, if we repeat the definition of the word for him. But we might reestablish the connection in various ways: we might point to a blue object and say "that is blue", or say "remember your blue

patch" or we perhaps utter the German word "blau", etc. etc. And if I now say there are these different ways in which we can establish the connection this suggests there's a single particular phenomenon I call the connection

between word and colour, or the understanding of the word, a phenomenon I've produced in all these different ways, just as I can use objects of different shapes and materials as conductors to connect the ends of two wires. But there is no need for such a phenomenon of connection, no need, say, that when I hear the word a picture of the colour should occur before my inner eye. For if what is reestablished in his understanding of the word, this can manifest itself in very various processes. There isn't a further process hidden behind, which is the real understanding, accompanying and causing these manifestations in the way that toothache causes one to groan, hold one's cheek, pull faces, etc. If I am now asked if I think that there's no such thing as understanding but only manifestations of understanding, I must answer that this question is as senseless as the question whether there is a number three. I can only describe piecemeal the grammar of the word "understand" and point out that it differs from what one is inclined to portray without looking closely. We are like the little painter Klecksel who drew two eyes in a man's profile, since he knew that human beings have two eyes.

Page 80

39 The effect of an explanation of the meaning of a word is like 'knowing how to go on', when you recite the beginning of a poem to someone until he says "now I know how to go on". (Tell yourself the various psychological forms this knowing how to go on may take.)

Page 80

The way in which language was learnt is not *contained* in its use. (Any more than the cause is contained in the effect.)

Page 80

How does an ostensive definition work? Is it put to work again

Page Break 81

every time the word is used, or is it like a vaccination which changes us once and for all?

Page 81

A definition as a part of the calculus cannot act at a distance. It acts only by being applied.

Page 81

40 Once more: in what cases shall we say that the man understands the word "blue"? Well, if he picks out a blue object from others on demand; or if he credibly says that he could now pick out the blue object but doesn't want to (perhaps we notice that while he says this he glances involuntarily at the blue object; perhaps we believe him simply on account of his previous behaviour). And how does *he* know that he understands the word? i.e. in what circumstances will *he* be able to say it? Sometimes after some kind of test, but sometimes also without. But in that case won't he sometimes have to say later "I was wrong, I did not understand it after all" if it turns out that he can't apply it? Can he justify himself in such cases by saying that he did indeed understand the word when he said he did, but that the meaning later slipped his memory? Well, what can he offer as a criterion (proof) that he did understand the word at the previous time?--Perhaps he says "At that time I saw the colour in my mind's eye, but now I can't remember it." Well, if that implies that he understood it, he did understand it then.--Or he says: "I can only say I've used the word a hundred times before", or "I'd used it just before, and while I was saying I understood it I was thinking of that occasion." It is what is regarded as the justification of an assertion that constitutes the sense of the assertion.

Page 81

Suppose we say "he understands the word 'blue', he picked the blue ball out from the others right away" and then he says "I just picked it out by guesswork, I didn't understand the word". What sort of criterion did he have for not having understood the word? Ought we to believe him? If one asks oneself "How do I know that

Page Break 82

I don't understand this word" it produces a very strange thought sensation. One wants to say "I don't connect anything with it", "it says nothing to me", "It's a mere noise", and in order to understand these utterances one has to call to mind what it's like "when one connects something with a word", when a definition has made the sound into a meaningful word, when one can *do something* with the word.

Page 82

You will say: "But he certainly can't be wrong when he says that he didn't understand the word." And that is an observation about the grammar of the statement "I didn't understand the word". It is also an observation about grammar when we say, "Whether he understood, is something he knows which we cannot *know* but only guess". Moreover the statement "I didn't understand the word" doesn't describe a state at the time of hearing the word; there are many different ways in which the processes characteristic of not understanding may have taken place later.

Page 82

41 We speak of understanding (a process of understanding, and also a state of understanding) and also of certain

processes which are criteria for this understanding.

Page 82

We are inclined to call understanding a mental process or a state of mind. This characterizes it as a *hypothetical* process etc., or rather as a process (or state) in the sense of a hypothesis. That is, we banish the word "understanding" to a particular region of grammar.

Page 82

The grammar of a mental state or process is indeed in many respects similar to that of e.g. a brain-process. The principal difference is perhaps that in the case of a brain-process a direct check is admitted to be possible; the process in question may perhaps be seen by opening the skull. But there is no room for a similar "immediate perception" in the grammar of mental process. (There is no such move in this game.)

Page Break 83

Page 83

What is the criterion for our understanding the word "red"? That we pick out a red object from others on demand, or that we can give the ostensive definition of the word "red"?

Page 83

We regard both things as signs of understanding. If we hear someone use the word "red" and are in doubt whether he understands it, we can check by asking: "which colour do you call red?" On the other hand, if we'd given someone the ostensive definition of the word and then wanted to see whether he'd understood it rightly, we wouldn't ask him to repeat it, but we would set him a task like picking out the red objects from a row.

Page 83

Here it can be asked: "are we talking about *my* understanding or other people's understanding?"

Page 83

"Only I can know whether I understand, others can only guess." "He understands' is a hypothesis; 'I understand' is not."

Page 83

If that's what we say, then we're conceiving "understanding" as an experience, analogous e.g. to a pain.

Page 83

People say: "You cannot know whether I understand (whether I am glad), etc.; you can't look inside me." "You can't know what I think." Yes, but that's so only as long as you don't think aloud; and we aren't interested here in the difference between thinking out loud (or in writing) and thinking in the imagination.

Page 83

Here you may object that thinking is after all private even if it is only the *visual* experience of writing, and that though another person can see what my physical hand is writing he cannot have my visual experience. These questions must occupy us in another place.

Page 83

But for our present purpose can't we say "he is writing" and "I am writing" instead of "he understands" and "I understand?"

Page 83

Then we leave the question of experience *completely* out of the

Page Break 84

game. Also, for instance, the question of private understanding. For then it appears unimportant here.

Page 84

What we call "understanding" is not the behaviour--whatever it may be--that shows us the understanding, but a state of which this behaviour is a sign. And that is a statement about the grammar of denoting such a state.

Page 84

42 We might call the recital of the rules on its own a criterion for understanding, or alternatively tests of use on their own. Then in the one case "he understands" would mean: "if you ask him for for [[sic]] the rules, he will tell you them"; in the other case "if you require him to apply the rule, he will carry out your order".

Page 84

Or we may regard the recital of the rules as a symptom of the man's being able to do something other than recite the rules. As when I hold a watch to my ear, hear it ticking and say: it is going. In that case I don't just expect it to go on ticking, but also to show the time.

Page 84

One might say: "The recital of the rules is a criterion of understanding, if the man recites them with understanding and not purely mechanically." But here once again an intelligent intonation during the recitation can

count as understanding; and so why not the recitation itself?

Page 84

To understand is to grasp, to receive a particular impression from an object, to let it work on one. To let a proposition work on one; to consider consequences of the proposition, to imagine them, etc.

Page 84

What we call "understanding" is a psychological phenomenon that has a special connection with the phenomena of learning and using our human language.

Page 84

What happens when I remember the meaning of a word? I see before me an object of a certain colour and I say "this book is

Page Break 85

brown and I have always called this colour 'brown'. What sort of act of remembering must take place for me to be able to say that? This question could be put in a much more general form. For instance, if someone asked me "have you ever before seen the table at which you are now sitting?" I would answer "yes, I have seen it countless times". And if I were pressed I would say "I have sat at it every day for months".--What act or acts of remembering occur in such a case? After all I don't see myself in my mind's eye "sitting at this table every day for months". And yet I say that I remember that I've done so, and I can later corroborate it in various ways. Last summer too, for example, I was living in this room. But how do I know that? Do I see it in my mind's eye? No. In this case what does the remembering consist of? If I as it were hunt for the basis of the memory, isolated pictures of my earlier sojourn surface in my mind; but even so they don't have, say, a date written into them. And even before they've surfaced and before I've called any particular evidence into my mind, I can say truly that I remember that I lived here for months and saw this table. Remembering, then, isn't at all the mental process that one imagines at first sight. If I say, rightly, "I remember it" the most *varied* things may happen; perhaps even just that I say it. And when I here say "rightly" of course I'm not laying down what the right and wrong use of the expression is; on the contrary I'm just describing the actual use.

Page 85

The psychological process of understanding is in the same case as the arithmetical object Three. The word "process" in the one case, and the word "object" in the other produce a false grammatical *attitude* to the word.

Page 85

43 Isn't it like this? First of all, people use an explanation, a chart, by looking it up; later they as it were look it up in the head (by calling it before the inner eye, or the like) and finally they work

Page Break 86

without the chart, as if it had never existed. In this last case they are playing a different game. For it isn't as if the chart is still in the background, to fall back on; it is excluded from our game, and if I "fall back on it" I am like a blinded man falling back on the sense of touch. An explanation provides a chart and when I no longer use the chart it becomes mere history.

Page 86

I must distinguish between the case in which I follow the table, and the case in which I behave in accordance with the table without making use of it.--The rule we learnt which makes us now behave in such and such a way is of no interest to us considered as the cause or history behind our present behaviour.--But as a general description of our manner of behaving it is a hypothesis. It is the hypothesis that the two people who sit at the chess board will behave (move) in such and such a manner. (Here even a breach of the rules falls under the hypothesis, since it says something about the behaviour of the players when they become aware of the breach). But the players might also use the rules by looking up in each particular case what is to be done; here the rule would enter into the conduct of the game itself and would not be related to it as hypothesis to confirmation. But there is a difficulty here. For a player who plays without using the list of rules, and indeed has never seen one, might nevertheless if asked give the rules of his game--not by ascertaining through repeated observation what he does in such and such a position in the game, but by superintending a move and saying "in such a case *this is how one moves*".--But, if that is so, that just shows that in certain circumstances he can enunciate the rules, not that he makes explicit use of them while playing.

Page 86

It is a hypothesis that he will if asked recite a list of rules; if a disposition or capacity for this is postulated in him, it is a psychological disposition analogous to a physiological one. If it is said

Page Break 87

that this disposition characterizes the process of playing, it characterizes it as the psychological or physiological one

it really is. (In our study of symbolism there is no foreground and background; it isn't a matter of a tangible sign with an accompanying intangible power or understanding.)

Page 87

44 What interests *us* in the sign, the meaning which matters for us is what is embodied in the grammar of the sign.

Page 87

We ask "How do you use the word, what do you do with it"--that will tell us how you understand it.

Page 87

Grammar is the account books of language. They must show the actual transactions of language, everything that is not a matter of accompanying sensations.

Page 87

In a certain sense one might say that we are not concerned with nuances.

Page 87

(I could imagine a philosopher who thought that he must have a proposition about the essence of knowing printed in red, otherwise it would not really express what it was meant to express.)

Page Break 88

IV

Page 88

45 The interpretation of written and spoken signs by ostensive definitions is not an *application* of language, but part of the grammar. The interpretation remains at the level of generality preparatory to any application.

Page 88

The ostensive definition may be regarded as a rule for translating from a gesture language into a word language. If I say "the colour of this object is called 'violet'", I must already have denoted the colour, already presented it for christening, with the words "the colour of that object" if the naming is to be able to take place. For I might also say "the name of this colour is for you to decide" and the man who gives the name would in that case already have to know what he is to name (where in the language he is stationing the name).

Page 88

That one empirical proposition is true and another false is no part of grammar. What belongs to grammar are all the conditions (the method) necessary for comparing the proposition with reality. That is, all the conditions necessary for the understanding (of the sense).

Page 88

In so far as the meaning of words becomes clear in the fulfilment of an expectation, in the satisfaction of a wish, in the carrying out of an order etc., it already shows itself when we put the expectation into language. It is therefore completely determined in the grammar, in what could be foreseen and spoken of already before the occurrence of the event.

Page 88

46 Does our language consist of primary signs (ostensive gestures) and secondary signs (words)? One is inclined to ask, whether it isn't the case that our language *has* to have primary signs while it could get by without the secondary ones.

Page 88

The false note in this question is that it expects an explanation of

Page Break 89

existing language instead of a mere description.

Page 89

It sounds like a ridiculous truism to say that a man who thinks that gestures are the primitive signs underlying all others would not be able to replace an ordinary sentence by gestures.

Page 89

One is inclined to make a distinction between rules of grammar that set up "a connection between language and reality" and those that do not. A rule of the first kind is "this colour is called 'red'",--a rule of the second kind is " $\sim\sim p = p$ ". With regard to this distinction there is a common error; language is not something that is first given a structure and then fitted on to reality.

Page 89

One might wish to ask: So is it an accident that in order to define signs and complete the sign-system I have to go outside the written and spoken signs? When I do that don't I go right into the realm where what is to be described occurs?--But in that case isn't it strange that I can do anything at all with the written signs?--We say perhaps that the written signs are mere representatives of the things the ostensive definition points to.--But how then

is this representing possible? I can't after all make just anything stand in for anything else.--It is indeed important that such representing is possible; for the representative must, in certain cases at least, do the job as well as the principal.

Page 89

47 We say that something like a red label is the primary sign for the colour red, and the word is a secondary sign, because the meaning of the word "red" is explained if I point, etc. to a red label, but not if I say "red" means the same as "rouge". But don't I explain the meaning of the word "red" to a Frenchman in just this way? "Yes, but only because he has learnt the meaning of 'rouge' by *ostensive* definition". But if he understands my explanation "red =

Page Break 90

rouge" does he have to have this definition--or a red image--present to his mind? If not, it is mere history. Must he have such a picture present whenever we would say he was using the word "rouge" with understanding? (Think of the order: "Imagine a round red patch.")

Page 90

48 Are the signs one wants to call 'primary' incapable of being misinterpreted?

Page 90

Can one perhaps say, they don't really any longer need to be *understood*?--If that means that they don't have to be further *interpreted*, that goes for words too; if it means, they *cannot* be further interpreted, then it's false. (Think of the explanation of gestures by words and vice versa).

Page 90

Is it correct, and if so in what sense, to say that the ostensive definition is like the verbal definition in replacing one sign by another--the pointing by the word?

Page 90

49 Suppose I lay down a method of designation. Suppose, for example, I want to give names to shades of colours for my private use. I may do so by means of a chart; and of course I won't write a name beside a wrong colour (beside a colour I don't want to give that name to). But why not? Why shouldn't "red" go beside the green label and "green" beside the red, etc.? If the ostensive definition merely replaces one sign by another, that shouldn't make any difference.--Here there are at any rate two different possibilities. It may be that the table with green beside "red" is used in such a way that a man who 'looks it up' goes diagonally from the word "red" to the red label, and from the word "green" to the green one and so on. We would then say that though the table was arranged differently (had a different spatial scheme) it connected the signs in the same way as the usual one.--But it might also be that the person using the table looks from one side horizontally to another, and in some sentences uses a green label instead of the word "red", and yet obeys an order like "give me a

Page Break 91

red book" not by bringing a green book, but perfectly correctly by bringing a red one (i.e. one that we too would call "red"). Such a man would have used the table in a different way from the first, but still in such a way that the word "red" means the same colour for him as it does for us.

Page 91

Now it is the second case which interests us, and the question is can a green label be a *sample* of red?--

Page 91

I can imagine an arrangement according to which a man to whom I show a green label with the words "paint me this colour" is to paint me red and if I show him blue with the same words, is to paint me yellow (always the complementary colour). And someone might interpret my order in that way even without such a convention. The convention might also have been "if I say, 'paint this colour', then always paint one slightly darker", and again we could imagine the order being thus interpreted even without this prearrangement.--But can it be said that when someone is painting a certain shade of green he is *copying* the red of the label--as he may copy a geometrical figure according to various methods of projection, copying it in different but equally exact ways?--Can I compare colours with shapes? Can a green label be used both as the name of a particular shade of red, and also as a sample of it just as a circle can serve as the name of a particular elliptical shape, and also as a sample for it?

Page 91

It is clear that a sample is not used like a word (a name). And an ostensive definition, a table, which leads us from words to samples, is used differently from a table which replaces one name by another.

Page 91

50 However, the word "copy" has different meanings in different cases and what I mean by "pattern" changes correspondingly. What does "to copy a figure exactly" mean? Does it mean copy it exactly with the unaided eye? Or with measuring instruments, and if so which? What shall we be willing to call the same colour as that of the pattern?

Think of various methods of comparison. How far is the rule to copy darker comparable to a rule to copy a figure

Page Break 92

on a larger, or small scale?

Page 92

Imagine a man who claimed to be able to copy shades of red into green, who fixed his eye on a red sample and with every outward sign of exact copying mixed a shade of green. For us he would be on a par with someone who listened carefully and mixed colours in accordance with notes on a violin. In such a case we'd say "I don't know *how* he does it"; not because we didn't understand the processes in his brain or in his muscles, but because we don't understand what is meant by "this shade of colour is a copy of this note on the violin". Unless that means that as a matter of experience a man associates a particular shade of colour with a particular note (sees it in his mind's eye, paints it etc). The difference between the meanings of "associate" and "copy" shows itself in the fact that it doesn't make sense to speak of a projection-method (rule of translation) for association. We say: "you haven't copied correctly", but not "you haven't associated correctly".

Page 92

On the other hand it is certainly conceivable that human beings might agree so exactly with each other in associating colours with violin notes that one might say to another: "No, you haven't represented that violin note correctly, it was yellower than you painted it" and the other would answer something like "you're right, the same thought occurred to me".

Page 92

51 If the table connects the word with a sample, then it isn't indifferent which label the word is linked with when the table is consulted--"So then there are signs that are arbitrary and signs that are not!" Compare the giving of information by maps and drawings, with the giving of information by sentences. The sentences are no more arbitrary than the drawings are; only the words are arbitrary. On the other hand the projection of the maps is arbitrary; and how would you decide which of the two is the more arbitrary?

Page Break 93

Page 93

Certainly I can compare deciding on the meanings of words with deciding on a method of projection, such as that for the representation of spatial forms ("the proposition is a picture"). That is a good comparison, but it doesn't exempt us from investigating the way words signify, which has its own rules. We can of course say--that is, it accords with usage--that we communicate by signs whether we use words or patterns, but the game of acting in accordance with words is not the same game as acting in accordance with patterns. (Words are not essential to what we call "language", and neither are samples). Word-language is only one of many possible kinds of language, and there are transitions between one kind and another. (Think of two ways of writing the proposition "I see a red circle": it might be done by writing a circle and giving it the appropriate colour (red), or by writing a circle with a red patch beside it. Consider what corresponds in a map to the form of expression of a word-language.)

Page 93

52 "I won't insist that the red pattern in the explanatory chart must be horizontally opposite the word 'red', but there must be some sort of law for reading the table or it will lose its sense." But is there no law if the chart is read in the way indicated by the arrows of the following schema?

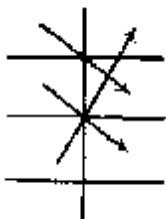

"But in that case *mustn't* this schema of arrows be given in advance?"--Well, must you give this schema before we follow the normal use?

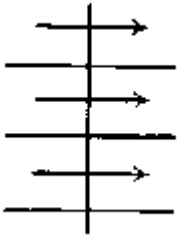

Page Break 94

Page 94

"But in that case mustn't there at least be a regularity through time in the use of the table? Would it work if we were to use the table in accordance with different schemata at different times? *How would one know* in that case how the table was to be used?" Well, how does one know *anyway*? Explanations of signs come to an end somewhere.

Page 94

Of course if I showed someone the way by pointing my finger not in the direction in which he was to go, but in the opposite direction, in the absence of a special arrangement I should cause a misunderstanding. It is part of human nature to understand pointing with the finger in the way we do. (As it is also part of human nature to play board games and to use sign languages that consist of written signs on a flat surface.)

Page 94

The chart doesn't guarantee that I shall pass from one part of it to another in a uniform manner. It doesn't compel me to use it always in the same way. It's there, like a field, with paths leading through it: but I can also cut across.--Each time I apply the chart I make a fresh transition. The transitions aren't made as it were once for all in the chart (the chart merely suggests to me that I make them).

Page 94

(What kind of propositions are these?--They are like the observation that explanations of signs come to an end somewhere. And that is rather like saying "How does it help you to postulate a creator, it only pushes back the problem of the beginning of the world." This observation brings out an aspect of my explanation that I perhaps hadn't noticed. One might also say: "Look at your explanation in *this* way--now are you still satisfied with it?")

Page 94

53 Is the word "red" enough to enable one to look for something red? Does one need a memory image to do so?

Page 94

Can one say that the word "red" needs a supplement in memory in order to be a usable sign?

Page 94

If I use the words "there is a red book in front of me" to describe an experience, is the justification of the choice of these words,

Page Break 95

apart from the experience described, the fact that I remember that I've always used the word "red" for this colour? Does that *have to* be the justification?

Page 95

In order to be able to *[[sic]]* obey a spoken order do we need something like a memory picture of what we did when we last obeyed it?

Page 95

So is the real order "Do now what you remember doing then"? This order too might be given. But does that mean that in order to obey it, I need a memory image of searching my memory?

Page 95

The order "do now what you remember doing then" tells me that I am to look in a particular place for a picture that will tell me what I am to do. So the order is very similar to "Do what is written on the piece of paper in this drawer". If there is nothing on the piece of paper then the order lacks sense.

Page 95

If the use of the word "red" depends on the picture that my memory automatically reproduces at the sound of this word, then I am as much at mercy of this reproduction as if I had decided to settle the meaning by looking up a chart in such a way that I would surrender unconditionally to whatever I found there.

Page 95

If the sample I am to work with appears darker than I remember it being yesterday, I need not agree with the memory and in fact I do not always do so. And I might very well speak of a darkening of my memory.

54 If I tell someone "paint from memory the colour of the door of your room" that doesn't settle what he is to do any more unambiguously than the order "paint the green you see on this chart". Here too it is imaginable that the first of the sentences might be understood in the way one would normally understand a sentence

like "paint a colour somewhat lighter than the one you remember seeing there". On the other hand the man ordered to paint the shade of colour in accordance with the sample will usually be in no doubt about the method of projection.

If I'm told: "look for a red flower in this meadow and bring it to me" and then I find one--do I compare it with my memory picture of the colour red?--And must I consult yet another picture to see whether the first is still correct?--In that case why should I need the first one?--I see the colour of the flower and recognize *it*. (It would naturally be *conceivable* that someone should hallucinate a colour sample and compare it, like a real sample, with the object he was looking for.)

But if I say "no, this colour isn't the right one, it's brighter than the colour I saw there" that doesn't mean that I see the colour in my mind's eye and go through a process of comparing two simultaneously given shades of colour. Again, it isn't as if when the right colour is found a bell rings somewhere in my mind and I carry round a picture of this ringing, so as to be able to judge when it rings.

Searching with a sample which one places beside objects to test whether the colours match is one game; acting in accordance with the words of a word-language without a sample is another. Think of reading aloud from a written text (or writing to dictation). We might of course imagine a kind of table that might guide us in this; but in fact there isn't one, there's no act of memory, or anything else, which acts as an intermediary between the written sign and the sound.

55 Suppose I am now asked "why do you choose *this* colour when given this order; how do you justify the choice?" In the one case I can answer "because *this* colour is opposite the word 'red' in my chart." In the other case there is no answer to the question and the question makes no sense. But in the first game there is no sense in *this* question: "why do you call 'red' the colour in the chart

opposite the word 'red'?" A *reason* can only be given *within* a game. The links of the chain of reasons come to an end, at the boundary of the game. (Reason and cause.)

If one calls to mind "that the chart does not compel us" to use it in a particular way, or even always to use it in the same way, it becomes clear to everyone that our use of the words "rule" and "game" is a fluctuating one (blurred at the edges).

The connection between "language and reality" is made by definitions of words, and these belong to grammar, so that language remains self-contained and autonomous.

56 Imagine a gesture language used to communicate with people who have no word-language in common with us. Do we feel there too the need to go outside the language to explain its signs?

"The connection between words and things is set up by the teaching of language." What kind or sort of connection is this? A mechanical, electrical, psychological connection is something which may or may not function. *Mechanism and Calculus*.

The correlation between objects and names is simply the one set up by a chart, by ostensive gestures and simultaneous uttering of the name etc. It is a part of the symbolism. Giving an object a name is essentially the same kind of thing as hanging a label on it.

It gives the wrong idea if you say that the connection between name and object is a psychological one.

57 Imagine someone copying a figure on the scale of 1 to 10. Is the understanding of the general rule of such mapping contained in the process of copying?--The pencil in my hand was free from

Page Break 98

presuppositions, so to speak, and was guided (influenced) only by the length of the lines in the pattern.--I would say that if the pattern had been longer, I should have drawn my pencil further and if it had been shorter, not so far. But is the mind which thus expresses itself already contained in the copying of the line?

Page 98

Suppose I want to meet someone on the street. I can decide "I will go on until I find N"--and then go along the street and stop when I meet him at a particular point. Did the process of walking, or some other simultaneous process, include acting in accordance with the general rule I intended? Or was what I did only *in agreement* with that rule, but also in agreement with other rules?

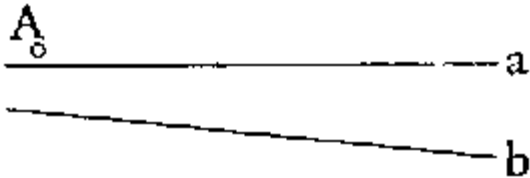

Page 98

I give someone the order to draw from A a line parallel to a. He tries (intends) to do it, but with the result that the line is parallel to b. Was what happened when he copied the same as if he had intended to draw a line parallel to b and carried out his intention?

Page 98

If I *succeed* in reproducing a paradigm in accordance with a prescribed rule, is it possible to use a different general rule to describe the process of copying, the way it took place? Or can I reject such a description with the words "No, I was guided by *this* rule, and not by the other, though admittedly in this case the other would have given the same result"?

Page 98

58 One is inclined to say: If I intentionally copy a shape, then the process of copying has the shape in common with the pattern. The form is a facet of the process of copying; a facet which fits the copied object and coincides with it there.

Page Break 99

Page 99

Even if my pencil doesn't do justice to the model, my intention always does.

Page 99

If I intend to play the piano from written music, it is experience that will show which notes I actually play and the description of what is played need not have anything in common with the written notes. But if I want to describe my *intention*, the description must be that I wanted to reproduce *these* written notes in sounds.--That alone can be the expression of the fact that intention reaches up to the paradigm and contains a general rule.

Page 99

An expression of intention describes the model to be copied; describing the copy does not.

Page 99

59 For the purposes of our studies it can never be essential that a symbolic phenomenon occurs in the mind and not on paper so that others can see it. One is constantly tempted to explain a symbolic process by a special psychological process; as if the mind "could do much more in these matters" than signs can.

Page 99

We are misled by the idea of a mechanism that works in special media and so can explain special movements. As when we say: this movement can't be explained by any arrangement of levers.

Page 99

A *description* of what is psychological must be something which can itself be used as a symbol.

Page 99

A connected point is that an explanation of a sign can replace the sign itself. This gives an important insight into the nature of the explanation of signs, and brings out a contrast between the idea of this sort of explanation and that of causal explanation.

Page 99

60 It could be said that it can't be decided by outward observation whether I am *reading* or merely producing sounds while a text runs before my eyes. But what is of interest to us in reading can't be essentially something *internal*. Deriving a translation from the

Page Break 100

original may also be a visible process. For instance, it must be possible to regard as a derivation what takes place on paper when the terms of the series 100, 121, 144, 169 are derived from the terms of the series 10, 11, 12, 13 by the following calculations

$$\begin{array}{r} 10 \times 10 \\ \hline 100 \end{array}, \quad \begin{array}{r} 11 \times 11 \\ \hline 121 \end{array}, \quad \begin{array}{r} 12 \times 12 \\ \hline 144 \end{array}, \quad \begin{array}{r} 13 \times 13 \\ \hline 169 \end{array}$$

Page 100

(The distinction between "inner" and "outer" does not interest us.)

Page 100

Every such more or less behaviourist account leaves one with the feeling that it is crude and heavy handed; but this is misleading we are tempted to look for a "better" account, but there isn't one. One is as good as the other and in each case what represents is the *system* in which a sign is used.--("Representation is dynamic, not static.")

Page 100

(Even a psychological process cannot "leave anything open" in any way essentially different from the way in which an empty bracket in the symbolism leaves open an argument place.)

Page 100

One may not ask "What sort of thing are mental processes, since they can be true and false, and non-mental ones cannot?" For, if the 'mental' ones can, then the others must be able to do as well and vice versa.--For, if the mental processes can, their descriptions must be able to as well. For how this is possible must show itself in their descriptions.

Page 100

If one says that thought is a mental activity, or an activity of the mind, one thinks of the mind as a cloudy gaseous medium in which many things can happen which cannot occur in a different sphere, and from which many things can be expected that are otherwise not possible.

Page 100

(The process of thinking in the human mind, and the process of digestion).

Page Break 101

Page 101

61 Every case of copying (acting *in obedience to*, not just in accordance with, particular rules), every case of *deriving* an action from a command or justifying an action by a command, is the same kind of thing as writing down the steps that lead to the answer of a sum, or pointing to signs standing beside each other in a table.

x	1	2	3	4
x ²				16
x ³				64

Page 101

"I write the number '16' here *because* it says 'x²' there, and '64' here because it says x³ there." That is what every justification looks like. In a certain sense it takes us no further. But indeed it can't take us *further* i.e. into the realm of metalogic.

Page 101

(The difficulty here is: in not trying to justify what admits of no justification.)

Page 101

Suppose, though, I said "I write a '+' here because it says 'x²' there? You would ask "Do you always write a '+'

where it says "x²"?--that is, you would look for a general rule; otherwise the "because" in my sentence makes no sense. Or you might ask "So how do you know that *that* is why you wrote it?"

Page 101

In that case you've taken the "because" as introducing a statement of the cause, instead of the reason.

Page 101

If I write "16" under "4" in accordance with the rule, it might appear that some causality was operating that was not a matter of hypothesis, but something immediately perceived (experienced).

Page 101

(Confusion between 'reason' and 'cause'.)

Page 101

What connection do I mean in the sentence "I am going out, *because* he's telling me to"? And how is this sentence related to "I am going out, *although* he told me to". (Or "I am going out, but not because he told me to" "I am going out, because he told me not to".)

Page Break 102

V

Page 102

62 "That's *him*" (this picture represents *him*)--that contains the whole problem of representation.

Page 102

What is the criterion, how is it to be verified, that this picture is the portrait of that object, i.e. that it is *meant* to represent it? It is not similarity that makes the picture a portrait (it might be a striking resemblance of one person, and yet be a portrait of someone else it resembles less).

Page 102

How can I know that someone means the picture as a portrait of N?--Well, perhaps because he says so, or writes it underneath.

Page 102

What is the connection between the portrait of N and N himself? Perhaps, that the name written underneath is the name used to address him.

Page 102

When I remember my friend and see him "in my mind's eye", what is the connection between the memory image and its subject? The likeness between them?

Page 102

Well, the image, *qua picture*, can't do more than resemble him.

Page 102

The image of him is an unpainted portrait.

Page 102

In the case of the image too, I have to write his name under the picture to make it the image of him.

Page 102

I have the intention of carrying out a particular task and I make a plan. The plan in my mind is supposed to consist in my seeing myself acting thus and so. But how do I know, that it is myself that I'm seeing? Well, it isn't myself, but a kind of a picture. But why do I call it the picture of *me*?

Page 102

"How do I know that it's myself?": the question makes sense if it means, for example, "how do I know that I'm the one I see there". And the answer mentions characteristics by which I can be recognized.

Page 102

But it is my own decision that makes my image represent myself. And I might as well ask "how do I know that the word 'I' stands for myself?" For my shape in the picture was only another word "I".

Page Break 103

Page 103

"I can imagine your being about to go out of the door." We suffer from a strange delusion that in the proposition, the thought, the objects do what the proposition states about them. It's as though the command contained a shadow of the execution. But a shadow of just *this* execution. It is *you* in the command who go to such and such a place.--Otherwise it would be just a *different* command.

Page 103

This identity is indeed the identity contrasted with the diversity of two different commands.

Page 103

"I thought Napoleon was crowned in the year 1805."--What has your thought got to do with Napoleon?--What connection is there between your thought and Napoleon?--It may be, for example, that the word "Napoleon" occurs in the expression of my thought, plus the connection that word had with its bearer; e.g. that was the way he signed his name, that was how he was spoken to and so on.

Page 103

"But when you utter the word 'Napoleon' you designate that man and no other"--"How then does this act of designating work, in your view? Is it instantaneous? Or does it take time?"--"But after all if someone asks you 'did you mean the very man who won the battle of Austerlitz' you will say 'yes'. So you meant that man *when you uttered the sentence*."--Yes, but only in the kind of way that I then knew also that $6 \times 6 = 36$.

Page 103

The answer "I meant the victor of Austerlitz" is a new step in our calculus. The past tense is deceptive, because it looks as if it was giving a description of what went on "inside me" while I was uttering the sentence.

Page 103

("But I meant *him*". A strange process, this meaning! Can you mean in Europe someone who's in America? Even if he no longer exists?)

Page 103

63 Misled by our grammar, we are tempted to ask "*How* does one think a proposition, *how* does one expect such and such to happen? (how does one do that?)"

Page Break 104

Page 104

"How does thought work, how does it use its expression?"--This question looks like "How does a Jacquard loom work, how does it use the cards".

Page 104

In the proposition "I believe that p is the case" we feel that the essential thing, the real process of belief, isn't expressed but only hinted at; we feel it must be possible to replace this hint by a description of the mechanism of belief, a description in which the series of words "p" would occur as the cards occur in the description of the loom. This description, we feel, would be at last the full expression of the thought.

Page 104

Let's compare belief with the utterance of a sentence; there too very complicated processes take place in the larynx, the speech muscles, the nerves, etc. These are *accompaniments* of the spoken sentence. And the sentence itself remains the only thing that interests us--not as part of a mechanism, but as part of a calculus.

Page 104

"How does thought manage to represent?"--the answer might be "Don't you really know? You certainly see it when you think." For nothing is concealed.

Page 104

How does a sentence do it? Nothing is hidden.

Page 104

But given this answer "But you know how sentences do it, for nothing is concealed" one would like to say "yes, but it all goes by so quick, and I should like to see it as it were laid open to view".

Page 104

We feel that thoughts are like a landscape that we have seen and are supposed to describe, but don't remember exactly enough to describe how all the parts fitted together. Similarly, we think, we can't describe thought after the event because then the many delicate processes have been lost sight of. We would like as it were to see these intricacies under the magnifying glass. (Think of the proposition "Everything is in flux".)

Page Break 105

Page 105

We ask: "What is a thought? What kind of thing must something be to perform the function of thought?" This question is like: "What is a sewing machine, how does it work?"--And the answer which would be like ours would be "Look at the stitch it is meant to sew; you can see from that what is essential in the machine, everything else is optional."

Page 105

So what is the function, that makes thought what it is?--

Page 105

If it is its *effect*, then we are not interested in it.

Page 105

We are not in the realm of causal explanations, and every such explanation sounds trivial for our purposes.

Page 105

64 If one thinks of thought as something specifically human and organic, one is inclined to ask "could there be a prosthetic apparatus for thinking, an inorganic substitute for thought?" But if thinking consists only in writing or speaking, why shouldn't a machine do it? "Yes, but the machine doesn't know anything." Certainly it is senseless to talk of a prosthetic substitute for seeing and hearing. We do talk of artificial feet, but not of artificial pains in the foot.

Page 105

"But could a machine think?"--Could it be in pain?--Here the important thing is what one means by something *being in pain*. I can look on another person--another person's *body*--as a machine which is in pain. And so, of course, I can in the case of my own body. On the other hand, the phenomenon of pain which I describe when I say something like "I have toothache" doesn't presuppose a physical body. (I can have toothache without teeth.) And in this case there is no room for the machine.--It is clear that the machine can only replace a physical body. And in the sense in which we can say of such a body that it is in pain, we can say it of a machine as well. Or again, what we can compare with machines and call machines is the *bodies* we say are in pain.

Page Break 106

Page 106

In the consideration of our problems one of the most dangerous ideas is the idea that we think *with*, or *in*, *our heads*.

Page 106

The idea of a process in the head, in a completely enclosed space, makes thinking something occult.†1

Page 106

"Thinking takes place in the head" really means only "the head is connected with thinking".--Of course one says also "I think with my pen" and this localisation is at least as good.

Page 106

It is a travesty of the truth to say "Thinking is an activity of our mind, as writing is an activity of the hand". (Love in the heart. The head and the heart as loci of the soul).

Page 106

65 We may say "Thinking is operating with symbols". But 'thinking' is a fluid concept, and what 'operating with symbols' is must be looked at separately in each individual case.

Page 106

I might also say "Thinking is operating with language" but 'language' is a fluid concept.

Page 106

It is correct to say "Thinking is a mental process" only if we also call seeing a written sentence or hearing a spoken one a mental process. In the sense, that is, in which pain is called a mental state. In that case the expression "mental process" is intended to distinguish 'experience' from 'physical processes'.--On the other hand, of course, the expression "mental process" suggests that we are concerned with imperfectly understood processes in an inaccessible sphere.

Page 106

Psychology too talks of 'unconscious thought' and here "thought" means a process in a mind-model. ('Model' in the sense in which one speaks of a mechanical model of electrical processes).

Page 106

By contrast, when Frege speaks of the thought a sentence expresses the word "thought" is more or less equivalent to the expression "sense of the sentence".

Page Break 107

Page 107

It might be said: in every case what is meant by "thought" is the *living* element in the sentence, without which it is dead, a mere succession of sounds or series of written shapes.

Page 107

But if I talked in the same way about a something that gives meaning to an arrangement of chessmen, something that makes it different from an arbitrary collection of bits of wood, I might mean almost anything! I might mean the rules that make the arrangement of chessmen a position in a game, or the special experiences we connect with positions in the game or the use of the game.

Page 107

It is the same if we speak of a something that makes the difference between paper money and mere printed

bits of paper, something that gives it its meaning, its life.

Page 107

Though we speak of a thought and its expression, the thought is not a kind of condition that the sentence produces as a potion might. And communication by language is not a process by which I use a drug to produce in others the same pains as I have myself.

Page 107

(What sort of process might be called "thought-transference" or "thought-reading"?)

Page 107

66 A French politician once said it was a special characteristic of the French language that in French sentences words occurred in the sequence in which one thinks them.

Page 107

The idea that one language in contrast to others has a word order which corresponds to the order of thinking arises from the notion that thought is an essentially different process going on independently of the expression of the thoughts.

Page 107

(No one would ask whether the written multiplication of two numbers in the decimal system runs parallel with the thought of the multiplication.)

Page 107

"I meant something definite by it, when I said..."

Page 107

--"Did you mean something different when you said each word, or did you mean the same thing throughout the whole sentence?"

Page Break 108

Page 108

It is strange, though: you can mean something by each word and the combination of them can still be nonsense!

Page 108

"At the time when you said the sentence, did you think of the fact that..."

Page 108

"I thought only what I said."

Page 108

(It perplexes us that there is no moment at which the thought of a sentence is completely present. Here we see that we are comparing the thought with a thing that we manufacture and possess as a whole; but in fact as soon as one part comes into being another disappears. This leaves us in some way unsatisfied, since we are misled by a plausible simile into expecting something different.)

Page 108

Does the child learn only to talk, or also to think? Does it learn the sense of multiplication *before* or *after* it learns multiplication?

Page 108

Is it, as it were, a contamination of the sense that we express it in a particular language which has accidental features, and not as it were bodiless and pure?

Page 108

Do I really not play chess itself because the chessmen might have had a different shape?

Page 108

(Is a mathematical proof in the general theory of irrational numbers less general or rigorous because we go through it using the decimal notation for those numbers? Does it impair the rigour and purity of the proposition $25 \times 25 = 625$ that it is written down in a particular number system?)

Page 108

Thought can only be something common-or-garden and *ordinary*. (We are accustomed to thinking of it as something ethereal and unexplored, as if we were dealing with something whose exterior alone is known to us, and whose interior is yet unknown like our brain.) One is inclined to say: "Thought, what a strange thing!" But when I say that thought is something quite common-or-garden, I mean that we are affected by this concept as we are by a concept like that of the number one. There seems to be something mysterious about it, because we misunderstand its grammar and feel the lack of a tangible substance

Page Break 109

to correspond to the substantive. (It is almost like hearing a human voice coming from in front of us, and seeing nobody there.)

Page 109

67 What does man think for? What use is it? Why does he *calculate* the thickness of the walls of a boiler and not leave it to chance or whim to decide? After all it is a mere fact of experience that boilers do not explode so often if made according to calculations. But just as having once been burnt he would do anything rather than put his hand into the fire, so he would do anything rather than not calculate for a boiler.--Since we are not interested in causes, we might say: human beings do in fact think: this, for instance, is how they proceed when they make a boiler.--Now, can't a boiler produced in this way explode? Certainly it can.

Page 109

We think over our actions before we do them. We make pictures of them--but why? After all, there is no such thing as a "thought-experiment".

Page 109

We expect something, and act in accordance with the expectation; must the expectation come true? No. Then why do we act in accordance with the expectation? Because we are impelled to, as we are impelled to get out of the way of a car, to sit down when we are tired, to jump up if we have sat on a thorn.

Page 109

What the thought of the uniformity of nature amounts to can perhaps be seen most clearly when we fear the event we expect. Nothing could induce me to put my hand into a flame--although after all it is *only in the past* that I have burnt myself.

Page 109

The belief that fire will burn me is of the same nature as the fear that it will burn me.

Page 109

Here I see also what "it is certain" means.

Page 109

If someone pushed me into the fire, I would struggle and go on

Page Break 110

resisting; and similarly I would cry out "it will burn me!" and not "perhaps it will be quite agreeable".

Page 110

"But after all you do believe that more boilers would explode if people did not calculate when making boilers!" Yes, I believe it;--but what does that mean? Does it follow that there will in fact be fewer explosions?--Then what is the foundation of this belief?

Page 110

68 I assume that his house in which I am writing won't collapse during the next half hour.--When do I assume this? The whole time? And what sort of an activity is this assuming?

Page 110

Perhaps what is meant is a psychological disposition; or perhaps the thinking and expressing of particular thoughts. In the second case perhaps I utter a sentence which is part of a train of thought (a calculation). Now someone says: you must surely have a reason to assume that, otherwise the assumption is unsupported and worthless.--(Remember that we stand on the earth, but the earth doesn't stand on anything else; children think it'll have to fall if it's not supported). Well, I do have reasons for my assumption. Perhaps that the house has already stood for years, but not so long that it may already be rickety, etc. etc.--*What* counts as a reason for an assumption can be given *a priori* and determines a calculus, a system of transitions. But if we are asked now for a reason for the calculus itself, we see that there is none.

Page 110

So is the calculus something we adopt arbitrarily? No more so than the fear of fire, or the fear of a raging man coming at us.

Page 110

"Surely the rules of grammar by which we act and operate are not arbitrary!" Very well; why then does a man think in the way he does, why does he go through these activities of thought? (This question of course asks for reasons, not for causes.) Well, reasons can be given within the calculus, and at the very end one is tempted to say "it just is very probable, that things will behave in this case as they always have"--or something similar. A turn of

Page Break 111

phrase which masks the beginning of the chain of reasons. (The creator as the explanation at the beginning of the world).†1

The thing that's so difficult to understand can be expressed like this. *As long as* we remain in the province of the true-false games a change in the grammar can only lead us from *one* such game to another, and never from something true to something false. On the other hand if we go outside the province of these games, we don't any longer call it 'language' and 'grammar', and once again we don't come into contradiction with reality.

VI

69 What is a proposition?--What am I distinguishing a proposition from? What do I want to distinguish it from? From things which are only parts of propositions in the same grammatical system (like the parts of an equation)? Or from everything we don't call propositions, including this chair and my watch, etc. etc?

The question "how is the general concept of proposition bounded?" must be countered with another: "Well, do we have a *single* concept of proposition?"

"But surely I have a definite concept of what I mean by 'proposition'." Well, and how would I explain it to another or to myself? This explanation will make clear what my concept is (I am not concerned with a feeling accompanying the word 'proposition'). I would explain the concept by means of examples.--So my concept goes as far as the examples.--But after all they're only examples, and their range is capable of extension.--All right, but in that case you must tell me what "capable of extension" means here. The grammar of this word must have definite boundaries.

"But I know a proposition when I see one, so I must also be able to draw the boundaries of the concept precisely." But is it really the case that no doubt is possible?--Imagine a language in which all sentences are commands to go in a particular direction. (This language might be used by a primitive kind of human beings exclusively in war. Remember how restricted the use of written language once was.) Well, we would still call the commands "come here", "go there", "sentences". †1 But suppose now the language consisted only in pointing the finger in one direction or the other.--Would this sign still be a proposition?--And what about a language like the early speech of children whose signs expressed only desire for particular objects, a language which consisted simply of signs for these objects (of nouns, as it were)? Or consider

a system consisting of two signs, one expressing acceptance and the other rejection of proffered objects. Is this a language, does it consist of propositions?

And on the other hand: does everything that sounds like a sentence in English fall under our concept of *proposition*? "I am tired", " $2 \times 2 = 4$ ", "time passes", "there is only one zero"?

The word "proposition" does not signify a sharply bounded concept. If we want to put a concept with sharp boundaries beside our use of this word, we are free to define it, just as we are free to narrow down the meaning of the primitive measure of length "a pace" to 75 cm.

70 "What happens when a new proposition is taken into the language: what is the criterion for its being a proposition?" Let us imagine such a case. We become acquainted with a new experience, say the tingling of an electric shock, and we say it's unpleasant. What right have I to call this newly formed statement a "proposition"? Well, what right did I have to speak of a new "experience", or a new "muscular sensation"? Surely I did so by analogy with my earlier use of these words. But, on the other hand, did I *have* to use the word "experience" and the word "proposition" in the new case? Do I already assert something about the sensation of the electric shock when I call it an experience? And what difference would it make if I excluded the statement "the tingling is unpleasant" from the concept of proposition, because I had already drawn its boundaries once and for all?

Compare the concept of proposition with the concept 'number' and then with the concept of cardinal number. We count as numbers cardinal numbers, rational numbers, irrational numbers, complex numbers; whether we call other constructions numbers because of their similarities with these, or draw a definitive boundary here or

elsewhere, depends on us. In this respect the concept of number is like the concept of proposition. On the

Page Break 114

other hand the concept of cardinal number $[1, \xi, \xi + 1]$ can be called a rigorously circumscribed concept, that's to say it's a concept in a different sense of the word.

Page 114

71 How did I come by the concept 'proposition' or the concept 'language'? Only through the languages I've learnt.--But in a certain sense they seem to have led me beyond themselves, since I'm now able to construct a new language, for instance to invent words.--So this construction too belongs to the concept of language. But only if I so stipulate. The sense of my "etc." is constantly given limits by its grammar.

Page 114

That's also what I meant when I said "there are surprises in reality but not in grammar."

Page 114

"But language can expand"--Certainly; but if this word "expand" has a sense here, then I know *already* what I mean by it. I must be able to specify how I imagine such an expansion. And what I can't think, I can't now express or even hint at. And in *this* case the word "now" means: "in this calculus" or "if the words are used according to *these* grammatical rules".

Page 114

But here we also have this nagging problem: how is it possible even to *think* of the existence of things when we always see only images, copies of them?--We ask: "Then how did I come by this concept at all?" It would be quite correct to add in thought the rider: "It is not as if I was able to transcend my own thought", "It is not as if I could sensibly transcend what has sense for me." We feel that there is no way of smuggling in by the back door a thought I am barred from thinking directly.

Page 114

No sign leads us beyond itself, and no argument either.

Page Break 115

Page 115

What does a man do when he constructs (invents) a new language; on what principle does he operate? For this principle is the concept of 'language'. Does every newly constructed language broaden (alter) the concept of language?--Consider its relationship to the earlier concept: that depends on how the earlier concept was established.--Think of the relation of complex numbers to the earlier concept of number; and again of the relation of a *new* multiplication to the general concept of the multiplication of cardinal numbers, when two particular (perhaps very large) cardinal numbers are written down for the first time and multiplied together.

Page 115

72 In logic one cannot employ generality in a void. If I determine the grammar of my generality, then there are no more surprises in logic. And if I do not determine it, then I am no longer in the realm of an exact grammar.

Page 115

That's to say, the indeterminacy of generality is not a logical indeterminacy. Generality is a freedom of movement, not an indeterminacy of geometry.

Page 115

But if the general concept of language dissolves in this way, doesn't philosophy dissolve as well? No, for the task of philosophy is not to create a new, ideal language, but to clarify the use of our language, the existing language. Its aim is to remove particular misunderstandings; not to produce a real understanding for the first time.

Page 115

If a man points out that a word is used with several different meanings, or that a certain misleading picture comes to mind when we use a certain expression, if he sets out (tabulates) rules according to which certain words are used, he hasn't committed himself to giving an explanation (definition) of the words "rule", "proposition", "word", etc.

Page 115

I'm allowed to use the word "rule" without first tabulating the rules for the use of the word. And those rules are not super-rules.

Page Break 116

Page 116

Philosophy is concerned with calculi in the same sense as it is concerned with thoughts, sentences and languages. But if it was really concerned with the concept of calculus, and thus with the concept of the calculus of all

calculi, there would be such a thing as metaphilosophy. (But there is not. We might so present all that we have to say that this would appear as a leading principle.)

Page 116

73 How do we use the word "rule", say when we are talking of games? In contrast to what?--We say for instance "that follows from this rule", but in that case we could cite the rule in question and thus avoid the word "rule". Or we speak of "all the rules of a game" and in that case either we've listed them (in which case we have a repetition of the first case) or we're speaking of the rules as a group of expressions produced in a certain way from given basic rules, and then the word "rule" stands for the expression of *those* basic rules and operations. Or we say "*this* is a rule and *that* isn't"--if the second, say, is only an individual word or a sentence which is incomplete by the standards of English grammar, or the illustration of a position of pieces in a game. (Or "No, according to the new convention that too is a rule"). If we had to write down the list of rules of the game, something like that might be said and then it would mean "*this* belongs in it and *that* doesn't". But this isn't on the strength of a particular property, the property of being a rule, like the case when one wants to pack only apples in a box and says, "no, that shouldn't go in there, that's a pear".

Page 116

Yes, but there are many things we call games and many we don't, many things we call rules and many we don't!--But it's never a question of drawing a boundary between everything we call games and everything else. For us games are *the* games of which we have heard, the games we can list, and perhaps some others newly devised by analogy; and if someone wrote a book on games, he wouldn't really need to use the word "game" in the title of the book, he could use as a title a list of the names of the individual games.

Page Break 117

Page 117

If he's asked "but what's *common* to all these things that makes you collect them together?" he might say: I can't give it straight off--but surely you may see many analogies. Anyway the question seems to me idle, because proceeding by analogy, I can also come by imperceptible steps to things that no one in ordinary life would any longer call "games". Hence I call games things on this list, and whatever is similar to these games up to a certain point that I don't further specify. Moreover, I reserve the right to decide in every new case whether I will count something as a game or not.

Page 117

The case is the same with the concepts 'rule', 'proposition', 'language', etc. It is only in special cases (i.e. not every time we use the word "rule") that it is a question of drawing a boundary between rules and what are not rules, and in all cases it is easy to give the distinguishing mark. We use the word "rule" in contrast to "word", "projection" and some other words and these demarcations can be clearly drawn. On the other hand we commonly do not draw boundaries where we do not need them. (Just as in certain games a single line is drawn in the middle of the field to separate the sides, but the field is not otherwise bounded since it is unnecessary.)

Page 117

We are able to use the word "plant" in a way that gives rise to no misunderstanding, yet countless borderline cases can be constructed in which no one has yet decided whether something still falls under the concept 'plant'. Does this mean that the meaning of the word "plant" in all other cases is infected by uncertainty, so that it might be said we use the word without understanding it? Would a definition which bounded this concept on several sides make the meaning of the word clearer to us in *all* sentences? Would we understand better all the sentences in which it occurs?

Page 117

74 How did we learn to understand the word "plant", then? Perhaps we learnt a definition of the concept, say in botany, but I leave out that of account since it only has a role in botany. Apart

Page Break 118

from that, it is clear that we learnt the meaning of the word by example; and if we disregard hypothetical dispositions, these examples stand only for themselves. Hypotheses about learning and using language and causal connections don't interest us. So we don't assume that the examples produce something in the learner, that they set before his mind an essence, the meaning of the concept-word, the concept 'plant'. If the examples should have an effect, say they produce a particular visual picture in the learner, the causal connection between the examples and this picture does not concern us, and for us they are merely *coincidental*. So we can perhaps disregard the examples altogether and look on the picture alone as a symbol of the concept; or the picture and the examples together.

Page 118

If someone says "we understand the word 'chair', since we know what is common to all chairs"--what does it

mean to say we *know* that? That we are ready to say it (like "we know that 6×6 is 36")? What is it that is common, then? Isn't it only because we can apply the word "chair" that we say here we know what is common? Suppose I explained the word "red" by pointing to a red wall, a red book, and a red cloth and in accordance with this explanation someone produced a sample of the colour red by exhibiting a red label. One might say in this case that he had shown that he had grasped the common element in all the examples I gave him. Isn't it an analogy like this that misleads us in the case of "chair"?

Page 118

The grammatical place of the words "game", "rule", etc. is given by examples in rather the way in which the place of a meeting is specified by saying that it will take place *beside* such and such a tree.

Page 118

75 One imagines the meaning as something which *comes before* our minds when we hear a word.

Page 118

What comes before our minds when we hear a word is certainly something characteristic of the meaning. But what comes before

Page Break 119

my mind is an example, an application of the word. And this coming to mind doesn't really consist in a particular image's being present whenever I utter or hear the word, but in fact that when I'm asked the meaning of the word, applications of the word *occur* to me.

Page 119

Someone says to me: "Shew the children a game" I teach them gaming with a dice, and the other says "I didn't mean that sort of game". Must the exclusion of the game with dice have come before his mind when he gave me the order?

Page 119

Suppose someone said: "No. I didn't mean that sort of game; I used 'game' in the narrower sense." How does it come out, that he used the word in the narrower sense?

Page 119

But can't one also use the word "game" in its broadest sense? But which is that? No boundaries have been drawn unless we fix some on purpose.

Page 119

If we found a sentence like "The Assyrians knew various games" in a history book without further qualifications, it would strike us as very curious; for we wouldn't be certain that we could give an example that even roughly corresponded to the meaning of the word "game" in this case.

Page 119

Someone wants to include in the list of rules of a game the proposition that the game was invented in such and such a year. I say "No, that doesn't belong to the list of rules, that's not a rule." So I'm excluding historical propositions from the rules. And similarly I would exclude from the rules, as an empirical proposition, a proposition like "this game can only be learnt by long practice". But it could easily be misleading to say boundaries had thereby been drawn around the area of rules.

Page 119

76 If I try to make clear to someone by characteristic examples

Page Break 120

the use of a word like "wish", it is quite likely that the other will adduce as an objection to the examples I offered another one that suggests a different type of use. My answer then is that the new example may be useful in discussion, but isn't an objection to my examples. For I didn't want to say that those examples gave the essence of what one calls "wishing". At most they present different essences which are all signified by this word because of certain inter-relationships. The error is to suppose that we wanted the examples to illustrate the essence of wishing, and that the counter examples showed that this essence hadn't yet been correctly grasped. That is, as if our aim were to give a theory of wishing, which would have to explain every single case of wishing.

Page 120

But for this reason, the examples given are only useful if they are clearly worked out and not just vaguely hinted at.

Page 120

The use of the words "proposition", "language", etc. has the haziness of the normal use of concept-words in our language. To think this makes them unusable, or ill-adapted to their purpose, would be like wanting to say "the warmth this stove gives is no use, because you can't feel where it begins and where it ends".

If I wish to draw sharp boundaries to clear up or avoid misunderstandings in the area of a particular use of language, these will be related to the fluctuating boundaries of the natural use of language in the same way as sharp contours in a pen-and-ink sketch are related to the gradual transitions between patches of colour in the reality depicted.

Socrates pulls up the pupil who when asked what knowledge is enumerates cases of knowledge. And Socrates doesn't regard that as even a preliminary step to answering the question.

But our answer consists in giving such an emuneration and a

few analogies. (In a certain sense we are always making things easier and easier for ourselves in philosophy.)

77 The philosophy of logic speaks of sentences and words in exactly the sense in which we speak of them in ordinary life when we say "Here is a Chinese sentence", or "No, that only looks like writing; it is actually just an ornament" and so on.

We are talking about the spatial and temporal phenomenon of language, not about some non-spatial, non-temporal phantasm. But we talk about it as we do about the pieces in chess when we are stating the rules of the game, not describing their physical properties.

The question "what is a word?" is analogous to "What is a piece in chess (say the king)?"

In reflecting on language and meaning we can easily get into a position where we think that in philosophy we are not talking of words and sentences in a quite common-or-garden sense, but in a sublimated and abstract sense.--As if a particular proposition wasn't really the thing that some person utters, but an ideal entity (the "class of all synonymous sentences" or the like). But is the chess king that the rules of chess deal with such an ideal and abstract entity too?

(We are not justified in having any more scruples about our language than the chess player has about chess, namely none.)

Again, we cannot achieve any greater generality in philosophy than in what we say in life and in science. Here too (as in mathematics) we leave everything as it is.

When I talk about language (words, sentences, etc.) I must speak the language of every day. Is this language somehow too coarse and material for what we want to say? Then how is another one to be constructed?--And how strange that we should be able to do anything at all with the one we have!

In giving philosophical explanations about language I already have to use language full-blown (not some sort of preparatory, provisional one); this by itself shows that I can adduce only exterior facts about language.

"Yes, but then how can these explanations satisfy us?"--Well, your very questions were framed in this language!--And your scruples are misunderstandings. Your questions refer to words, so I have to talk about words.

You say: the point isn't the word, but its meaning, and you think of the meaning as a thing of the same kind as the word, though also different from the word. Here the word, there the meaning. The money, and the cow that you can buy with it. (But contrast: money, and its use).

78 If we ask about the general form of proposition--bear in mind that in normal language sentences have a particular rhythm and sound but we don't call everything 'that sounds like a sentence' a sentence.--Hence we speak also of significant and non-significant "sentences".

On the other hand, sounding like a sentence in this way isn't essential to what we call a proposition in logic.

The expression "sugar good" doesn't sound like an English sentence, but it may very well replace the proposition "sugar tastes good". And not e.g. in such a way that we should have to add in thought something that is missing. (Rather, all that matters is the system of expressions to which the expression "sugar good" belongs.)

Page 122

So the question arises whether if we disregard this misleading business of sounding like a sentence we still have a general concept of proposition.

Page 122

Imagine the English language altered in such a way that the order of the words in a sentence is the reverse of the present one. The result would be the series of words which we get if we read sentences of an English book from right to left. It's clear that the multiplicity of possible ways of expression in this language must be exactly the same as in English; but if a longish sentence were read thus we could understand it only with great difficulty and we'd

Page Break 123

perhaps never learn "to think in this language". (The example of such a language can make clear a lot about the nature of what we call "thought".)

Page 123

79 The definition "A proposition is whatever can be true or false" fixes the concept of proposition in a particular language system as what in that system can be an argument of a truth-function.

Page 123

And if we speak of what makes a proposition a proposition, we are inclined to mean the truth-functions.

Page 123

"A proposition is whatever can be true or false" means the same as "a proposition is whatever can be denied".

"p" is true = p

"p" is false = $\sim p$

What he says is true = Things are as he says.

Page 123

One might say: the words "true" and "false" are only items in a particular notation for truth-functions.

Page 123

So is it correct to write "'p' is true", "'p' is false"; mustn't it be "p is true" (or false)? The ink mark is after all not *true*; in the way in which it's black and curved.

Page 123

Does "'p' is true" state anything about the sign "p" then? "Yes, it says that 'p' agrees with reality." Instead of a sentence of our word language consider a drawing that can be compared with reality according to exact projection-rules. This surely must show as clearly as possible what "'p' is true" states about the picture "p". The proposition "'p' is true" can thus be compared with the proposition "this object is as long as this metre rule" and "p" to the proposition "this object is one metre long". But the comparison is incorrect, because "this metre rule" is a description, whereas "metre rule" is the determination of a concept. On the other hand in "'p' is true" the ruler enters immediately into the proposition. "p" represents here simply the length and not the metre rule. For the representing drawing is also not 'true' except in accordance

Page Break 124

with a particular method of projection which makes the ruler a purely geometrical appendage of the measured line.

Page 124

It can also be put thus: The proposition "'p' is true" can only be understood if one understands the grammar of the sign "p" as a propositional sign; not if "p" is simply the name of the shape of a particular ink mark. In the end one can say that the quotation marks in the sentence "'p' is true" are simply superfluous.

Page 124

If one explains: "(x).fx" is true, if "f()" gives true sentences for all substitutions--we must reflect that the sentence "(x).fx" follows from the proposition 'f()' gives true sentences for all substitutions", and *vice versa*. So the two propositions say the same.

Page 124

So that explanation does not assemble the mechanism of generality from its parts.

Page 124

One can't of course say that a proposition is whatever one can predicate "true" or "false" of, as if one could put symbols together with the words "true" and "false" by way of experiment to see whether the result makes sense. For something could only be decided by this experiment if "true" and "false" already have definite meanings, and

they can only have that if the contexts in which they can occur are already settled.--(Think also of identifying parts of speech by questions. "Who or what...?")

Page 124

80 In the schema "This is how things stand" the "how things stand" is really a handle for the truth-functions.

Page 124

"Things stand", then, is an expression from a notation for truth-functions. An expression which shows us what part of grammar comes into play here.

Page 124

If I let "that is how things stand" count as the general form of proposition, then I must count " $2 + 2 = 4$ " as a proposition. Further rules are needed if we are to exclude the propositions of arithmetic.

Page Break 125

Page 125

Can one give the *general form of a proposition*?--Why not? In the same way as one might give the general form of a number, for example by the sign " $|0, \xi, \xi + 1|$ ". I am free to restrict the name "number" to *that*, and in the same way I can give an analogous formula for the construction of propositions or laws and use the word "proposition" or "law" as equivalent to that formula.--If someone objects and says that this will only demarcate certain laws from others, I reply: of course you can't draw a boundary if you've decided in advance not to recognize one. But of course the question remains: how do you use the word "proposition"? In contrast to what?

Page 125

("Can a proposition treat of all propositions, or all propositional functions?" What is meant by that? Are you thinking of a proposition of logic?--What does the proof of such a proposition look like?)

Page 125

A general propositional form determines a proposition as part of a calculus.

Page 125

81 Are the rules that say that such and such a combination of words yields no sense comparable to the stipulations in chess that the game does not allow two pieces to stand on the same square, for instance, or a piece to stand on a line between two squares? Those propositions in their turn are like certain actions; like e.g. cutting a chess board out of a larger sheet of squared paper. They draw a boundary.

Page 125

So what does it mean to say "this combination of words has no sense"? One can say of a name (of a succession of sounds): "I haven't given anyone this name"; and name-giving is a definite action (attaching a label). Think of the representation of an explorer's route by a line drawn in each of the two hemispheres projected on the page: we may say that a bit of line going outside the circles on the page makes no sense in this projection. We might also express it thus: no stipulation has been made about it.

Page Break 126

Page 126

"How do I manage always to use a word significantly? Do I always look up the grammar? No, the fact that I mean something,--what I mean prevents me from talking nonsense."--But what do I mean?--I would like to say: I speak of bits of an apple, but not bits of the colour red, because in connection with the words "bits of an apple", unlike the expression "bits of the colour red", I can imagine something, picture something, want something. It would be more correct to say that I *do* imagine, picture, or want something in connection with the words "bits of an apple" but not in connection [[sic]] with the expression "bits of the colour red".

Page 126

But the expression "I'm cutting red into bits" can have a sense (e.g. the sense of the proposition "I'm cutting something red into bits").--Suppose I asked: which word is it, which mistake, that makes the expression senseless? This shows that this expression, in spite of its senselessness, makes us think of a quite definite grammatical system. That's why we also say "red can't be cut into bits" and so give an answer; whereas one wouldn't make any answer to a combination of words like "is has good". But if one is thinking of a particular system, a language game plus its application, then what is meant by "'I'm cutting red into bits' is senseless" is first and foremost that this expression doesn't belong to the particular game its appearance makes it seem to belong to.

Page 126

If we do give a sense to the set of words "I'm cutting red into bits" how do we do it?--We can indeed turn it into quite different things; an empirical proposition, a proposition of arithmetic (like $2 + 2 = 4$), an unproved theorem of mathematics (like Goldbach's conjecture), an exclamation, and other things. So I've a free choice: how is it bounded? That's hard to say--by various types of utility, and by the expression's formal similarity to certain primitive

forms of proposition; and all these boundaries are blurred.

Page 126

"How do I know that the colour red can't be cut into bits?" That isn't a question either.

Page 126

I would like to say: "I must *begin* with the distinction between

Page Break 127

sense and nonsense. Nothing is possible prior to that. I can't give it a foundation."

Page 127

82 Can one ask: "How must we make the grammatical rules for words if they are to give a sentence sense"?

Page 127

I say, for instance: There isn't a book here, but there could be one; on the other hand it's nonsensical to say that the colours green and red could be in a single place at the same time. But if what gives a proposition sense is its agreement with grammatical rules then let's make just this rule, to permit the sentence "red and green are both at this point at the same time". Very well; but that doesn't fix the grammar of the expression. Further stipulations have yet to be made about how such a sentence is to be used; e.g. how it is to be verified.

Page 127

If a proposition is conceived as a picture of the state of affairs it describes and a proposition is said to show just how things stand if it's true, and thus to show the possibility of the asserted state of affairs, still the most that the proposition can do is what a painting or relief does: and so it can at any rate not set forth what is just not the case. So it depends wholly on our grammar what will be called possible and what not, i.e. what that grammar permits. But surely that is arbitrary! Certainly; but the grammatical constructions we call empirical propositions (e.g. ones which describe a visible distribution of objects in space and could be replaced by a representational drawing) have a particular application, a particular use. And a construction may have a superficial resemblance to such an empirical proposition and play a somewhat similar role in a calculus without having an analogous application; and if it hasn't we won't be inclined to call it a proposition.

Page 127

"Possible" here means the same as "conceivable"; but "conceivable" may mean "capable of being painted", "capable of being modelled", "capable of being imagined"; i.e. representable

Page Break 128

in a particular system of propositions. What matters is the system.--For example someone asks: "is it conceivable that a row of trees might go on forever in the same direction without coming to an end?" Why shouldn't it be 'conceivable'? After all it's expressible in a grammatical system. But if so what's the application of the proposition? How is it verified? What is the relation between its verification and the verification of a proposition like "this row of trees ends at the hundredth tree"? That will tell us how much this conceivability is worth, so to speak.

Page 128

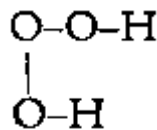

Chemically possible

†1

Page 128

"I haven't ever in fact seen a black line gradually getting lighter until it was white, and then more reddish until it was red: but I know that it is possible, because I can imagine it." The form of expression "I know that it is possible, because..." is taken from cases like "I know that it is possible to unlock the door with this key, because I once did so". So am I making *that* sort of conjecture: that the colour transition will be possible since I can imagine it?--Isn't this rather the way it is: here "the colour transition is possible" has the same meaning as "I can imagine it?" What about *this*: "The alphabet *can* be said aloud, *because* I can recite it in my mind"?

Page 128

"I can imagine the colour transition" isn't an assertion here about a particular power of my own imagination, in the way that "I can lift this stone" is about the power of my own muscles. The sentence "I can imagine the transition", like "this state of affairs can be drawn", connects the linguistic representation with another form of representation; it is to be understood as a proposition of grammar.

Page 128

83 It looks as if we could say: Word-language allows of senseless combination of words, but the language of imagining does not

allow us to imagine anything senseless. Hence too the language of drawing doesn't allow of senseless drawings.--But that isn't how it is: for a drawing can be senseless in the same way as a proposition. Think of a blueprint from which a turner is to work; here it is very easy to represent an exact analogy with a senseless pseudo-proposition. Remember too the example of drawing a route on a projection of the globe.

When one wants to show the senselessness of metaphysical turns of phrase, one often says "I couldn't imagine the opposite of that", or "What would it be like if it were otherwise?" (When, for instance, someone has said that my images are private, that only I alone can know if I am feeling pain, etc.) Well, if I can't imagine how it might be otherwise, I equally can't imagine that it is *so*. For here "I can't imagine" doesn't indicate a lack of imaginative power. I can't even *try* to imagine it; it makes no sense to say "I imagine it". And that means, no connection has been made between this sentence and the method of representation by imagination (or by drawing).

But why does one say "I can't imagine how it could be *otherwise*" and not "I can't imagine the thing itself"? One regards the senseless sentence (e.g. "this rod has a length") as a tautology as opposed to a contradiction. One says as it were: "Yes, it has a length; but how could it be otherwise; and why say so?" To the proposition "This rod has a length" we respond not "Nonsense!" but "Of course!" We might also put it thus: when we hear the two propositions, "This rod has a length" and its negation "This rod has no length", we take sides and favour the first sentence, instead of declaring them both nonsense. But this partiality is based on a confusion: we regard the first proposition as verified (and the second as falsified) by the fact "that the rod has a length of 4 metres". "After all, 4 metres is a length"--but one forgets that this is a grammatical proposition.

It is often possible to show that a proposition is meant metaphysically by asking "Is what you affirm meant to be an empirical proposition? Can you conceive (imagine) its being otherwise?"--Do you mean that substance has never yet been destroyed, or that it is *inconceivable* that it should be destroyed? Do you mean that experience shows that human beings always prefer the pleasant to the unpleasant?

How strange that one should be able to say that such and such a state of affairs is inconceivable! If we regard thought as essentially an accompaniment going with an expression, the words in the statement that specify the inconceivable state of affairs must be unaccompanied. So what sort of sense is it to have? Unless it says these words are senseless. But it isn't as it were their sense that is senseless; they are excluded from our language like some arbitrary noise, and the reason for their *explicit* exclusion can only be that *we are tempted* to confuse them with a sentence of our language.

84 The role of a sentence in the calculus is its sense.

A *method* of measurement--of length, for example--has exactly the same relation to the correctness of a statement of length as the sense of a sentence has to its truth or falsehood.

What does "discovering that an assertion doesn't make sense" mean?--and what does it mean to say: "If I mean something by it, surely it must make sense to say it"? "If I mean something by it"--if I mean *what* by it?--

One wants to say: a significant sentence is one which one can not merely say, but also think. But that would be like saying: a significant picture is one that can not merely be drawn but also represented plastically [[sic]]. And saying this would make sense. But the thinking of a sentence is not an activity which one does from the words (like singing from a score). The following example shews this.

Does it make sense to say "The number of my friends is equal to a root of the equation $x^2 + 2x - 3 = 0$ "? Here, one might think,

we have a notation whose grammar doesn't settle by itself whether a sentence makes sense or not, so that it wasn't determined in advance. That is a fine example of what is meant by understanding a proposition.

If the expression "the root of the equation..." were a Russellian description, then the proposition "I have n apples and $2 + n = 6$ " would have a different sense from the proposition "I have 4 apples".

Page 131

The sense of a proposition (or atthought) isn't anything spiritual; it's what is given as an answer to a request for an explanation of the sense. Or: one sense differs from another in the same way as the explanation of the one differs from the explanation of the other. So also: the sense of one proposition differs from the sense of another in the same way as the one proposition differs from the other.

Page 131

The sense of a proposition is not a soul.

Page 131

It is only in a language that something is a proposition. To understand a proposition is to understand a language.

Page 131

A proposition is a sign in a system of signs. It is *one* combination of signs among a number of possible ones, and as opposed to other possible ones. As it were *one* position of an indicator as opposed to other possible ones.

Page 131

"Go in the direction the arrow points."

"Go a hundred times as far as the arrow is long."

"Go as many paces as I draw arrows."





"Draw a copy of this arrow."

"Come at the time shown by this arrow considered as the hour hand of a clock."

Page 131

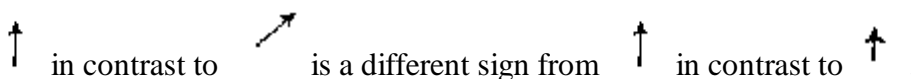
For all of these commands the same arrow might do.

Page 131

 in contrast to  is a different sign from  in contrast to  .

Page Break 132

VII

Page 132

85 Symbols appear to be of their nature unsatisfied.

Page 132

Wishes, conjectures, beliefs, commands appear to be something unsatisfied, something in need of completion. Thus I would like to characterize my feeling of grasping a command as a feeling of an innervation. But the innervation in itself isn't anything unsatisfied, it doesn't leave anything open, or stand in need of completion.

Page 132

And I want to say: "A wish is unsatisfied because it's a wish *for something*; opinion is unsatisfied, because it's the opinion that something is the case, something real, something outside the process of opining."

Page 132

I would like to say: "my expectation is so made that whatever happens has to accord with it or not".

Page 132

The proposition seems set over us as a judge and we feel answerable to it.--It seems to demand that reality be compared with it.

Page 132

I said that a proposition was laid against reality like a ruler. And a ruler--like all logical comparisons for a proposition--is itself in a particular case a propositional sign. Now one would like to say: "Put the ruler against a body: it does not say that the body is of such-and-such a length. Rather it is in itself dead and achieves nothing of what thought achieves." It is as if we had imagined that the essential thing about a living being was the outward form. Then we made a lump of wood in that form, and were abashed to see the stupid block, which hasn't even any similarity to life.

Page 132

86 I want to say: "if someone could see the process of expectation, he would necessarily be seeing what was expected."--But that is the case: if you see the expression of an expectation you see what is being expected. And in what other way, in what other sense would it be possible to see it?

Page Break 133

Page 133

When we give an order, it can look as if the ultimate thing sought by the order had to remain unexpressed, as there is always a gulf between an order and its execution. Say I want someone to make a particular movement, say to raise his arm. To make it quite clear, I do the movement. This picture seems unambiguous till we ask: how does he know that *he is to make that movement?*--How does he know at all what use he is to make of the signs I give him, whatever they are? Perhaps I shall now try to supplement the order by means of further signs, by pointing from myself to him, making encouraging gestures etc. Here it looks as if the order were beginning to stammer.

Page 133

Suppose I wanted to tell someone to square the number 4, and did so by means of the schema:

$$\begin{array}{c|c} x & 4 \\ \hline x^2 & ? \end{array}$$

Page 133

Now I'm tempted to say that the question mark only hints at something it doesn't express.

Page 133

As if the sign were precariously trying to produce understanding in us. But if we now understand it, by what token do we understand?

Page 133

The appearance of the awkwardness of the sign in getting its meaning across, like a dumb person who uses all sorts of suggestive gestures--this disappears when we remember that the sign does its job only in a grammatical system.

Page 133

(In logic what is unnecessary is also *useless*.)

Page 133

87 In what sense can one call wishes as such, beliefs, expectations etc. 'unsatisfied'? What is the prototype of nonsatisfaction from which we take our concept? Is it a hollow space? And would one call that unsatisfied? Wouldn't this be a metaphor too? Isn't what we call nonsatisfaction a feeling--say hunger?

Page Break 134

Page 134

In a particular system of expressions we can describe an object by means of the words "satisfied" and "unsatisfied". For example, if we lay it down that we call a hollow cylinder an "unsatisfied cylinder" and the solid cylinder that fills it its "satisfaction".

Page 134

It seems as if the expectation and the fact satisfying the expectation fitted together somehow. Now one would like to describe an expectation and a fact which fit together, so as to see what this agreement consists in. Here one thinks at once of the fitting of a solid into a corresponding hollow. But when one wants to describe these two one sees that, to the extent that they fit, a *single* description holds for both. (On the other hand compare the meaning of: "These trousers don't go with this jacket"!)

Page 134

Expectation is not related to its satisfaction in the same way as hunger is related to its satisfaction. I can describe the hunger, and describe what takes it away, and say that it takes it away. And it isn't like this either: I have a wish for an apple, and so I will call 'an apple' whatever takes away the wish.

Page 134

88 The strange thing is expressed in the fact that if this is the event I expected, it isn't distinct from the one I expected.

Page 134

I say: "that's just how I imagined it"; and someone says something like "That's impossible, because the one was an image and the other isn't. Did you take your image for reality?"

Page 134

I see someone pointing a gun and say "I expect a report". The shot is fired.--Well, that was what you expected, so did that bang somehow already exist in your expectation? Or is it just that there is some other kind of agreement between your expectation and what occurred; that that noise was not contained in your expectation and merely accidentally supervened when the expectation was being fulfilled? But no, if the noise had not occurred, my expectation

would not have been fulfilled; the noise fulfilled it; it was not an accompaniment of the fulfilment like a second guest accompanying the one I expected.--Was the thing about the event that was not in the expectation too an accident, an extra provided by fate?--But then what was *not* an extra? Did something of the shot already occur in my expectation?--Then what was extra? for wasn't I expecting the whole shot?

"The report was not so loud as I had expected." "Then was there a louder bang in your expectation?"

"The red which you imagine is surely not the same (the same thing) as the red which you see in front of you; so how can you say that it is what you imagined?"--But haven't we an analogous case with the propositions "Here is a red patch" and "Here there isn't a red patch"? The word "red" occurs in both; so this word cannot indicate the presence of something red. The word "red" does its job only in the propositional context. Doesn't the misunderstanding consist in taking the meaning of the word "red" as being the sense of a sentence saying that something is red?

The possibility of this misunderstanding is also contained in the ambiguity of expressions like "the colour red as the common element of two states of affairs"--This may mean that in each something *is* red, has the colour red; or else that both propositions are about the colour red.

What is common in the latter case is the harmony between reality and thought to which indeed a form of our language corresponds.

89 If we say to someone "imagine the colour red" he is to imagine a patch or something that is red, not one that is green, since that is *not red*.

(Could one define the word "red" by pointing to something that was *not red*? That would be as if one were supposed to explain

the word "modest" to someone whose English was weak, and one pointed to an arrogant man and said "That man is *not* modest". That it is ambiguous is no argument against such a method of definition. Any definition can be misunderstood. But it might well be asked: are we still to call this "definition"?--For, of course, even if it has the same practical consequences, the same *effect* on the learner, it plays a different part in the calculus from what we ordinarily call "ostensive definition" of the word "red".)

It would be odd to say: "A process looks different when it happens from when it doesn't happen." Or "a red patch looks different when it is there from when it isn't there; but language abstracts from this *difference*, for it speaks of a red patch whether it is there or not."

Reality is not a property still missing in what is expected and which accedes to it when one's expectation is fulfilled.--Nor is reality like the daylight that things need to acquire colour, when they are already there, as it were colourless, in the dark.

"How do you know that you are expecting *a* red patch; that is, how do you know that a red patch is the fulfilment of your expectation?" But I might just as well ask: "how do you know that that *is* a red patch?"

How do you know that what you did really was to recite the alphabet in your head?--But how do you know that what you are reciting aloud really *is* the alphabet?

Of course that is the same question as "How do you know that what you call 'red' is really the same as what another calls 'red'?" And in its metaphysical use the one question makes no more sense than the other.

In these examples, I would like to say, you see how the words are really used.

90 One might think: What a remarkable process willing must be,

if I can now will the very thing I won't be doing until five minutes hence!

Page 137

How can I expect the event, when it isn't yet there at all?

Page 137

"Socrates: so if someone has an idea of what is not, he has an idea of nothing?--Theaetetus: It seems so. Socrates: But surely if he has an idea of nothing, then he hasn't any idea at all?--Theaetetus: That seems plain."†1

Page 137

If we put the word "kill", say, in place of "have an idea of" in this argument, then there is a rule for the use of this word: it makes no sense to say "I am killing something that does not exist". I can imagine a stag that is not there, in this meadow, but not kill one that is not there. And "to imagine a stag in this meadow" means to imagine *that* a stag is there. But to kill a stag does not mean to kill *that*... But if someone says "in order for me to be able to imagine a stag it must after all exist in some sense", the answer is: no, it does not have to *exist* in any sense. And if it should be replied: "But the colour brown at any rate must exist, for me to be able to have an idea of it"--then we can say 'the colour brown exists' means nothing at all; except that it exists here or there as the colouring of an object, and that is not necessary in order for me to be able to imagine a brown stag.

Page 137

We say that the expression of expectation 'describes' the expected fact and think of an object or complex which makes its appearance as fulfilment of the expectation.--But it is not the expected thing that is the fulfilment, but rather: its coming about.

Page 137

The mistake is deeply rooted in our language: we say "I expect him" and "I expect his arrival".

Page 137

It is difficult for us to shake off this comparison: a man makes his appearance--an event makes its appearance. As if an event even now stood in readiness before the door of reality and were then to make its appearance in reality--like coming into a room.

Page Break 138

Page 138

91 I can look for him when he is not there, but not hang him when he is not there.

Page 138

One might want to say: "But he must be somewhere there if I am looking for him."--Then he must be somewhere there too if I don't find him and even if he doesn't exist at all.

Page 138

A search for a particular thing (e.g. my stick) is a particular kind of search, and differs from a search for something else because of what one does (says, thinks) while searching, not because of what one finds.

Page 138

Suppose while I am searching I carry with me a picture or an image--very well. If I say that the picture is a picture of what I am looking for, that merely tells the place of the picture in the process of searching. And if I find it and say "There it is! *That's* what I was looking for" those words aren't a kind of definition of the name of the object of the search (e.g. of the words "my stick"), a definition that couldn't have been given until the object had been found.

Page 138

"You were looking for *him*? You can't even have known if he was there!" (Contrast looking for the trisection of the angle.)

Page 138

One may say of the bearer of a name that he does not exist; and of course that is not an activity, although one may compare it with one and say: he must be there all the same, if he does not exist. (And this has certainly already been written some time by a philosopher.)

Page 138

The idea that it takes finding to show what we were looking for, and fulfilment of a wish to show what we wanted, means one is judging the process like the symptoms of expectation or search in someone else. I see him uneasily pacing up and down his room; then someone comes in at the door and he relaxes and gives signs of satisfaction. And I say "obviously he was expecting this person."

Page 138

The symptoms of expectation are not the expression of expectation.

One may have the feeling that in the sentence "I expect he is coming" one is using the words "he is coming" in a different sense from the one they have in the assertion "he is coming". But if it were so, how could I say that my expectation had been fulfilled? And the words "he is coming" mean the same in the expression of expectation as in the description of its fulfilment, because if I wanted to explain the words "he" and "is coming", say by means of ostensive definitions, the same definitions of these words would go for both sentences.

But it might now be asked: what's it like for him to come?--The door opens, someone walks in, and so on.--What's it like for me to expect him to come?--I walk up and down the room, look at the clock now and then, and so on. But the one set of events has not the smallest similarity to the other! So how can one use the same words in describing them? What has become now of the hollow space and the corresponding solid?

But perhaps I say as I walk up and down: "I expect he'll come in." Now there is a similarity somewhere. But of what kind?!

But of course I might walk up and down in my room and look at the clock and so on without expecting him to come. I wouldn't describe doing that by saying "I expect he is coming". So what made it e.g. the expectation precisely of *him*?

I may indeed say: to walk restlessly up and down in my room, to look at the door, to listen for a noise is: to expect N.--That is simply a definition of the expression "to expect N". Of course it isn't a definition of the word "expect", because it doesn't explain what e.g. "to expect M" means. Well, we can take care of that; we say something like: to expect X means to act as described and to utter the name "X" while doing so. On this definition the person expected is the person whose name is uttered. Or I may give as a definition: to expect a person X is to do what I described in the second example, and to make a drawing of a person. In that case, the person expected is the bearer of the name X, the person who corresponds to the drawing.--That of course wouldn't explain

what "to expect N to go" means, and I would have to give either an independent definition of that, or a general definition including going and coming. And even that wouldn't explain say what "to expect a storm" means; etc. etc.

What characterizes all these cases is, that the definition can be used to read off the object of the expectation from the expectant behaviour. It isn't a later experience that decides *what* we are expecting.

And I may say: it is in language that expectation and its fulfilment make contact.

So *in this case* the behaviour of the expectant person is behaviour which can be translated in accordance with given rules into the proposition "He is expecting it to happen that p". And so the simplest typical example to illustrate this use of the word "expect" is that the expectation of its happening that p should consist in the expectant person *saying* "I expect it to happen that p". Hence in so many cases it clarifies the grammatical situation to say: let us put the expression of expectation in place of the expectation, the expression of the thought in place of the thought.

93 One can conceive expectation as expectant, preparatory behaviour. Expectation is like a player in a ball game holding his hands in the right position to catch the ball. The expectation of the player might consist in his holding out his hands in a particular way and looking at the ball.

Some will perhaps want to say: "An expectation is a thought". Obviously, that corresponds to one use of the word "expect". And we need to remember that the process of thinking may be *very various*.†1

And if expectation is the thought "I am expecting it to happen that p" it is senseless to say that I won't perhaps know until later what I expected.

Something analogous might be said of wishing, fear and hope. (Plato called hope "a speech"†1).

Page 141

But it is different if *hunger* is called "a wish", say the body's wish for food to satisfy it. For it is a hypothesis that just that will satisfy the wish; there's room for conjecture and doubt on the topic.

Page 141

Similarly if what I call "expectation" is a feeling, say a feeling of disquiet or dissatisfaction. But of course these feelings are not thoughts in an amorphous form.

Page 141

The idea of thought as an unexplained process in the human mind makes it possible to imagine it turned into a persistent amorphous condition.

Page 141

If I say "I have been expecting him all day", "expect" here doesn't mean a persistent condition including as ingredients the person expected and his arrival, in the way that a dough may contain flour, sugar and eggs mixed into a paste. What constitutes expectation is a series of actions, thoughts and feelings.

Page 141

94 When I expect someone,--what happens? I perhaps look at my calendar and see his name against today's date and the note "5 p.m." I say to someone else "I can't come to see you today, because I'm expecting N". I make preparations to receive a guest. I wonder "Does N smoke?", I remember having seen him smoke and put out cigarettes. Towards 5 p.m. I say to myself "Now he'll come soon", and as I do so I imagine a man looking like N; then I imagine him coming into the room and my greeting him and calling him by his name. This and many other more or less *similar* trains of events are called "expecting N to come".

Page Break 142

Page 142

But perhaps I'm also prepared to say "I have been expecting N" in a case where the only thing that connects him with my expectant activity is for instance that on a particular day I prepare a meal for myself and one other person, and that N. has announced his intention of taking that meal with me.

Page 142

What does the process or state of wanting an apple consist in? Perhaps I experience hunger or thirst or both, and meanwhile imagine an apple, or remember that I enjoyed one yesterday; perhaps I say "I would like to eat an apple"; perhaps I go and look in a cupboard where apples are normally kept. Perhaps all these states and activities are combined among themselves and with others.

Page 142

95 The same sort of thing must be said of intention. If a mechanism is *meant* to act as a brake, but for some reason does not slow down the motion of the machine, then the purpose of the mechanism cannot be found out *immediately* from it and from its effect. If you were to say "that is a brake, but it doesn't work" you would be talking about intention. But now suppose that whenever the mechanism didn't work as a brake a particular person became angry. Wouldn't the intention of the mechanism now be expressed in its effect? No, for now it could be said that the lever sometimes triggers the brake and sometimes triggers the anger. For how does it come out that the man is angry *because* the lever doesn't operate the brake? "Being annoyed that the apparatus does not function" is itself something like "wishing that it did function in that way".--Here we have the old problem, which we would like to express in the following way: "the thought that p is the case doesn't presuppose that it is the case; yet on the other hand there must be something in the fact that is a presupposition even of having the thought (I can't think that something is red, if the colour red does not exist)". It is the problem of the harmony between world and thought.--To this it may be replied that thoughts are in the same

Page Break 143

space as the things that admit of doubt; they are laid against them in the same way as a ruler is laid against what is to be measured.

Page 143

What I really want to say is this: the wish that he should come is the wish that really *he* should really *come*. If a further explanation of this assurance is wanted, I would go on to say "and by 'he' I mean that man there, and by 'come' I mean doing this..." But these are just grammatical explanations, explanations which *create* language.

Page 143

It is *in language* that it's all done.

Page 143

"I couldn't think that something is red if red didn't exist." What that proposition really means is the image of something red, or the existence of a red sample *as part of our language*. But of course one can't say that our language *has to* contain such a sample; if it didn't contain it, it would just be another, a different language. But one can say, and emphasize, that it does contain it.

Page 143

96 It's beginning to look somehow as if intention could never be recognized as *intention* from outside; as if one must be doing the meaning of it oneself in order to understand it as meaning. That would amount to considering it not as a phenomenon or fact but as something intentional which has a direction given to it. What this direction is, we do not know; it is something which is absent from the phenomenon as such.

Page 143

Here, of course, our earlier problem returns, because the point is that one has to read off from a thought that it is the thought that such and such is the case. If one can't read it off (as one can't read off the cause of a stomach-ache) then it is of no logical interest.

Page 143

My idea seems nonsensical if it is expressed like *this*. It's supposed to be possible to see what someone is thinking of by opening up his head. But how is that possible? The objects he's thinking about are certainly not in his head--any more than in his thoughts!

Page Break 144

Page 144

If we consider them 'from outside' we have to understand thoughts as thoughts, intentions as intentions and so on, *without* getting any information about something's meaning. For it is with the phenomenon of thinking that meaning belongs.

Page 144

If a thought is observed there can be no further question of an understanding; for if the thought is seen it must be recognized as a thought with a certain content; it doesn't need to be interpreted!--That really is how it is; when we are thinking, there isn't any interpretation going on.

Page 144

97 If I said "but that would mean considering intention as something other than a phenomenon" that would make intention reminiscent of the will as conceived by Schopenhauer. Every phenomenon seems dead in comparison with the living thought.

Page 144

"Intention seen from outside" is connected with the question whether a machine could think. "Whatever phenomenon we saw, it couldn't ever be intention; for that has to contain the very thing that is intended, and any phenomenon would be something complete in itself and unconcerned with anything outside itself, something merely dead if considered by itself."

Page 144

This is like when we say: "The will can't be a phenomenon, for whatever phenomenon you take is something that *simply happens*, something we undergo, not something we *do*. The will isn't *something* I see happen, it's more like my being involved in my actions, my *being* my actions." Look at your arm and move it and you will experience this very vividly: "You aren't observing it moving itself, you aren't having an experience--not just an experience, anyway--you're *doing* something." You may tell yourself that you could also imagine exactly the same thing happening to your hand, but merely observed and not willed by you. But shut your eyes, and move your arm so that you have, among other things, a certain experience: now ask yourself whether you still can imagine that you were having the same experience but without willing it.

Page Break 145

Page 145

If someone wants to express the distinction between voluntary and involuntary movements by saying that voluntary movements of the arm, for example, are differentiated from involuntary ones by a feeling of innervation, you feel an urge to say "But I don't *undergo* this experience, I *do* it --" But *can* one speak of a distinction between undergoing and doing in the case of an experience of innervation? I would like to say: "If I will, then there isn't anything that happens to me, neither the movement nor a feeling; I am the agent." Very well; but there's no doubt that you *also* have experiences when you voluntarily move your arm; because you *see* (and feel) it moving whether or not you take up the attitude of an *observer*. So just for once try to distinguish between *all the experiences* of acting plus the doing (which is not an experience) and *all* those experiences without the element of doing. Think over whether you still need this element, or whether it is beginning to appear redundant.--Of course you can say

correctly that when you do something, there isn't anything happening to you, because the phenomena of doing *are* different from the phenomena of observing something like a reflex movement. But this doesn't become clear until one considers the very different sorts of things that people call voluntary activities and that people call unintentional or involuntary processes in our life. (More about this in another place.)

Page 145

98 By "intention" I mean here what uses a sign in a thought. The intention seems to interpret, to give the final interpretation; which is not a further sign or picture, but something else, the thing that cannot be further interpreted. But what we have reached is a psychological, not a logical terminus.

Page 145

Think of a sign language, an 'abstract' one, I mean one that is strange to us, in which we do not feel at home, in which, as we should say, we do not *think* (we used a similar example once before), and let us imagine this language interpreted by a translation into--as we should like to say--an unambiguous picture-language, a language consisting of pictures painted in perspective. It is quite

Page Break 146

clear that it is much easier to imagine different *interpretations* of the written language than of a picture painted in the usual way depicting say a room with normal furniture. Here we shall also be inclined to think that there is no further possibility of interpretation.

Page 146

Here we might also say we didn't enter into the sign-language, but did enter into the painted picture.

Page 146

(This is connected with the fact that what we call a 'picture by similarity' is not a picture in accordance with some established method of projection. In this case the "likeness" between two objects means something like the possibility of mistaking one for the other.)

Page 146

"Only the intended picture reaches up to reality like a yardstick. Looked at from outside, there it is, lifeless and isolated."--It is as if at first we looked at a picture so as to enter into it and the objects in it surrounded us like real ones; and then we stepped back, and were now outside it; we saw the frame, and the picture was a painted surface. In this way, when we intend, we are surrounded by our intention's pictures and we are inside them. But when we step outside intention, they are mere patches on a canvas, without life and of no interest to us. When we intend, we exist among the pictures (shadows) of intention, as well as with real things. Let us imagine we are sitting in a darkened cinema and entering into the happenings in the film. Now the lights are turned on, though the film continues on the screen. But suddenly we see it "from outside" as movements of light and dark patches on a screen.

Page 146

(In dreams it sometimes happens that we first read a story and then are ourselves participants in it. And after waking up after a dream it is sometimes as if we had stepped back out of the dream and now see it before us as an alien picture.) And it also means something to speak of "living in the pages of a book". That is

Page Break 147

connected with the fact that our body is not at all essential for the occurrence of our experience. (Cf. eye and visual field.)

Page 147

(Compare also the remark: if we understand a sentence, it has a certain depth for us.)

Page 147

99 What happens is not that this symbol cannot be further interpreted, but: I do no interpreting. I do not interpret because I feel natural in the present picture. When I interpret, I step from one level of my thought to another.

Page 147

If I see the thought symbol "from outside", I become conscious that it *could* be interpreted thus or thus; if it is a step in the course of my thoughts, then it is a stopping-place that is natural to me, and its further interpretability does not occupy (or trouble) me. As I have a railway time-table and use it without being concerned with the fact that a table can be interpreted in various ways.

Page 147

When I said that my image wouldn't be a portrait unless it bore the name of its subject, I didn't mean that I have to imagine it and his name at the same time. Suppose I say something like: "What I see in my mind isn't just a picture which is like N (and perhaps like others too). No, I know that it is him, that he is the person it portrays." I might then ask: *when* do I know that and what does knowing it amount to? There's no need for anything to take place during the imagining that could be called "knowing" in this way. Something of that sort may happen after the

imagining; I may go on from the picture to the name, or perhaps say that I imagined N, even though at the time of the imagining there wasn't anything, except a kind of similarity, to characterize the image as N's. Or again there might be something preceding the image that made the connection with N. And so the interpretation isn't something that accompanies the image; what gives the image its interpretation is the *path* on which it lies.

Page 147

That all becomes clearer if one imagines images replaced by

Page Break 148

drawings, if one imagines people who go in for drawing instead of imagining.

Page 148

100 If I try to describe the process of intention, I feel first and foremost that it can do what it is supposed to only by containing an extremely faithful picture of what it intends. But further, that that too does not go far enough, because a picture, whatever it may be, can be variously interpreted; hence this picture too in its turn stands isolated. When one has the picture in view by itself it is suddenly dead, and it is as if something had been taken away from it, which had given it life before. It is not a thought, not an intention; whatever accompaniments we imagine for it, articulate or inarticulate processes, or any feeling whatsoever, it remains isolated, it does not point outside itself to a reality beyond.

Page 148

Now one says: "Of course it is not the picture that intends, but we who use it to intend." But if this intending, this meaning, is something that is done with the picture, then I cannot see why that has to involve a human being. The process of digestion can also be studied as a chemical process, independently of whether it takes place in a living being. We want to say "Meaning is surely essentially a mental process, a process of consciousness and life, not of dead matter." But what will give such a thing the specific character of what goes on?--so long as we speak of it as a process. And now it seems to us as if intending could not be any process at all, of any kind whatever.--For what we are dissatisfied with here is the grammar of *process*, not the specific kind of process.--It could be said: we should call any process 'dead' in this sense.

Page 148

Let's say the wish for this table to be a little higher is the act of my holding my hand above the table at the height I wish it to be. Now comes the objection: "The hand above the table can't be the wish: it doesn't express that the table is to be higher; it is

Page Break 149

where it is and the table is where it is. And *whatever other* gesture I made it wouldn't make any difference."

Page 149

(It might almost be said: "Meaning *moves*, whereas a process stands still.")

Page 149

101 However, if I imagine the expression of a wish as the act of wishing, the problem appears solved, because the system of language seems to provide me with a medium in which the proposition is no longer dead.

Page 149

If we imagine the expression of a wish as the wish, it is rather as if we were led by a train of thought to imagine something like a network of lines spread over the earth, and living beings who moved only along the lines.

Page 149

But now someone will say: even if the *expression* of the wish is the wish, still the whole language isn't present during this expression, yet surely the wish is!

Page 149

So how does language help? Well, it just isn't necessary that anything should be *present* except the expression.

Page 149

102 You might as it were locate (look up) all of the connections in the grammar of the language. There you can see the whole network to which the sentence belongs.

Page 149

Suppose we're asked "When we're thinking, meaning and so on why don't we come upon the bare picture?" We must tell ourselves that when we're thinking we don't wonder whether the picture is the thought or the meaning, we simply *use* pictures, sentences and so on and discard them one after the other.

Page 149

But of course if you call the picture the wish (e.g. that this table were higher) then what you're doing is comparing the picture with an expression of our language, and certainly it doesn't correspond to such an expression

unless it's part of a system translatable into our language.

Page 149

One says: how can this way of holding the hand, this picture

Page Break 150

be the wish that such and such were the case? It is nothing more than a hand over a table, and there it is, alone and without a *sense*. Like a single bit of scenery from the production of a play which has been left by itself. It had life only in the play.

Page 150

In the gesture we don't see the real shadow of the fulfilment, the unambiguous shadow that admits of no further interpretation.

Page 150

We ask: "does the hand above a table wish?" Does anything, spiritual or material, that we might add, wish? Is there any such situation or process that really contains what is wished?--And what is our paradigm of such containing? Isn't it our language? Where are we to find what makes the wish *this* wish, even though it's only a wish? Nowhere but in the expressed wish.

Page 150

"After all, the wish must show *what* is wished, it must prefigure in the realm of wishes that which is wished." But what actual process do you have in mind here as the prefiguring? (What is the mirror in which you think you saw what was wished?)

Page 150

"The gesture *tries* to prefigure" one wants to say "but it can't".

Page 150

103 Can one say that *while I'm wishing* my wish seems to prefigure the fulfilment? While I'm wishing it doesn't *seem* to do anything; I notice nothing odd about it. It's only considering the linguistic manifestation of the wish that produces this appearance.

Page 150

We are considering an event that we might call an instance of the wish that this table were higher. But this event *doesn't even seem* to contain the fulfilment. Now someone says: "But this event does have to be a shadow of the very state of affairs that is wished, and

Page Break 151

these actions aren't that." But why do you say that's what a wish has to be? "Well, because it's the wish that just that were the case". Precisely: that's the only answer you can give to the question. So after all that event is the shadow, insofar as it corresponds within a system to the expression of the wish in the word-language. (It is in language that wish and fulfilment meet.) Remember that the expression of a wish can be the wish, and that the expression doesn't derive its sense from the presence of some extraordinary spirit.

Page 151

Think also of a case very similar to the present one: "This table isn't 80 cm high". Must the fact that it is 90 cm, and so *not* 80 cm, high contain the shadow of the fact of its being 80 cm high? What gives this impression? When I see a table which is 90 cm high does it give a shadowy impression of having a height it doesn't have?

Page 151

This is rather as if we misunderstood the assertion " $\vdash \sim p$ " in such a way as to think that it contained the assertion " $\vdash p$ ", rather as " $\vdash p.q$ " contains in its sense " $\vdash p$ ".

Page 151

Someone describes to me what went on when he, as he says, had the wish that the table were 10 cm higher. He says that he held his hand 10 cm above the table. I reply "But how do you know that you weren't just wishing that the table were higher, since in that case too you would have held your hand at some height above the table." He says "After all, I must know what I wished" I reply "Very well, but I want to know *by what token* you remember when you remember your wish. What *happened* when you wished, and what makes you say you wished just that?" He says "I know that I *intentionally* held my hand just 10 cm above." I say "But what constituted just *that* intention?"--I might also ask "Is it certain that when you were wishing you were using the scale 1:1? How do you know that?"

Page 151

If he had described the process of wishing by saying "I said 'I would like to have the table 10 cm higher'", then the question

how he could know what he wished wouldn't have arisen. (Unless someone had gone on to ask: "And did you *mean* those words in the way they are usually meant?")

What it always comes to in the end is that without any further *meaning* he *calls* what happened the wish that that should happen. [Manifestation, not description.]

"How do I know it's *him* I'm remembering, if the remembering is a picture?" To what extent *do* I know it? ("When two men look perfectly alike, how can I remember one of them in particular?")

104 We say "A proposition isn't just a series of sounds, it is something more". We think of the way a Chinese sentence is a mere series of sounds for us, which just means that we don't understand it, and we say this is because we don't have any thoughts in connection with the Chinese sentence (e.g. the Chinese word for "red" doesn't call up any image in us). "So what distinguishes a significant sentence from mere sounds is the thoughts it evokes." The sentence is like a key-bit whose indentations are constructed to move levers in the soul in a particular way. The sentence, as it were, plays a melody (the thought) on the instrument of the soul. But why should I now hypothesize, in addition to the orderly series of words, another series of mental elements running parallel? That simply duplicates language with something else of the same kind.

Suppose the sentence is: "This afternoon N went into the Senate House." The sentence isn't a mere noise for me, it evokes an image of a man in the vicinity of the Senate House, or something similar. But the sentence and the image aren't just a noise plus a faint image; calling up the image, and having certain other consequences, is something as it were internal to the sentence; *that* is what its sense is. The image seems only a faint copy of the sense, or shall we say, only a single view of the sense.--But what do I mean by this? Don't I just see the sentence as part of a system of consequences?

Let us suppose that proposition evoked in me a very clear picture of N on the way to the Senate House and that in the picture there could also be seen the setting sun ("evening") and a calendar with today's date. Suppose that instead of letting the sentence call up this picture, I actually painted it and showed it to someone else as a means of communication in place of the sentence. He might say of this too that it expressed a thought but needed to be understood; what he would think of as an act of understanding would probably be a translation into word languages.

"I arrive in Vienna on the 24th of December." They aren't mere words! Of course not: when I read them various things happen inside me in addition to the perception of the words: maybe I feel joy, I have images, and so on.--But I don't just mean that various more or less inessential concomitant phenomena occur in conjunction with the sentence; I mean that the sentence has a definite sense and I perceive it. But then what is this definite sense? Well, that this particular person, whom I know, arrives at such and such a place etc. Precisely: when you are giving the sense, you are moving around in the grammatical background of the sentence. You're looking at the various transformations and consequences of the sentence as laid out in advance; and so they are, in so far as they are embodied in a grammar. (You are simply looking at the sentence as a move in a given game.)

I said that it is the *system* of language that makes the sentence a thought and makes it a thought *for us*.

That doesn't mean that it is while we are using a sentence that the system of language makes it into a thought for us, because the system isn't present then and there isn't any need for anything to make the sentence alive for us, since the question of being alive doesn't arise. But if we ask: "why doesn't a sentence strike us as isolated and dead when we are reflecting on its essence, its sense, the thought etc." it can be said that we are continuing to move in the system of language.

To match the words "I grasp the sense" or "I am thinking the thought of this sentence" you hypothesize a process which unlike the bare propositional sign contains these consequences.

105 "This queer thing, thought": but it does not strike us as queer while we are thinking *it*. It strikes us as queer

when we tell ourselves that it connects objects in the mind, because it is the very thought that *this person is doing that*; or that it isn't a sign or a picture, because I would still have to know how they were meant in their turn; or that thought isn't something dead, because *for me* what I think *really* happens.

Page 154

What is the source of this odd way of looking at things?

Page 154

What makes us think that a thought, or a proposition we think, contains the reality? It's that we're all ready to pass from it to the reality, and we feel this transition as something already potentially contained in it (when, that is, we reflect on it), because we say "that word *meant him*". We feel this transition as something just as legitimate as a permitted move in a game.

Page 154

Thought does not strike us as mysterious while we are thinking, but only when we say, as it were retrospectively: "How was that possible?" How was it possible for thought to deal with the very person *himself*? But here I am merely being astonished by my own linguistic expression and momentarily misunderstanding it.

Page 154

Thought strikes us as mysterious. But not while we think. And we don't mean that it's psychologically remarkable. It isn't only that we see it as an extraordinary way of producing pictures and signs, we actually feel as if by means of it we had caught reality in our net.

Page 154

It isn't while we're *looking at* it that it seems a strange process; but when we let ourselves be guided by language, when we look at what we say about it.

Page 154

We mistakenly locate this mystery in the nature of the process.

Page Break 155

(We interpret the enigma created by our misunderstanding as the enigma of an incomprehensible process.)

Page 155

106 "Thought is a remarkable process, because when I think of what will happen tomorrow, I am mentally already in the future." If one doesn't understand the grammar of the proposition "I am mentally in the future" one will believe that here the future is in some strange way caught in the sense of a sentence, in the meaning of words. Similarly people think that the endless series of cardinal numbers is somehow before our mind's eye, whenever we can use that expression significantly.

Page 155

"For me this portrait is *him*"? What does that mean? I have the same attitude to the portrait, as to the man himself. For I do of course distinguish between him and his picture.

Page 155

A thought experiment comes to much the same as an experiment which is sketched or painted or described instead of being carried out. And so the result of a thought experiment is the fictitious result of a fictitious experiment.

Page 155

"The sense of this proposition was present to me." What was it that happened?

Page 155

"Only someone who is *convinced* can say that".--How does the conviction help him when he says it?--Is it somewhere at hand by the side of the spoken expression? (Or is it masked by it, as a soft sound by a loud one, so that it can, as it were, no longer be heard when one expresses it out loud?) What if someone were to say "In order to be able to sing a tune from memory one has to hear it in one's mind and sing from that"?

Page 155

Try the following experiment: Say a sentence, perhaps "The weather is very fine today"; right, and now think the thought of the sentence, but unadulterated, without the sentence.

Page Break 156

Page 156

107 "It looks as if intention could never be recognized as intention "from outside", as if one must be doing the meaning of it oneself in order to understand it as meaning."†1

Page 156

Can one recognize stomach-ache as such "from outside"? What are stomach-aches "from outside"? Here there is no outside or inside! Of course, in so far as meaning is a specific experience, one wouldn't call any other

experience "meaning". Only it isn't any remarkable feature of the sensation which explains the directionality of meaning. And if we say "from outside intention cannot be recognised as intention etc." we don't want to say that meaning is a special experience, but that it isn't anything which happens, or happens to us, but something that we do, otherwise it would be just dead. (The subject--we want to say--does not here drop out of the experience but is so much involved in it that the experience cannot be described.)

Page 156

It is almost as if one said: we can't see ourselves going hither and thither, because it is we who are doing the going (and so we can't stand still and watch). But here, as so very often, we are suffering from an inadequate form of expression, which we are using at the very time we want to shake it off. We clothe the protest against our form of expression in an apparently factual proposition expressed in that very form. For if we say "we see ourselves going thither" we mean simply that we see what someone sees when he is going himself and not what he sees if someone else is going. And one does indeed have a particular visual experience if one is doing the going oneself.

Page 156

That is to say, what we are speaking of is a case in which contrary to experience the subject is linked like an element in a chemical compound. But where do we get this idea from? The concept of living activity in contrast with dead phenomena.

Page Break 157

Page 157

Imagine someone now saying: "going somewhere oneself isn't an experience".

Page 157

We want to say: "When we mean something, there isn't a dead picture (of any kind); it's as if we went up to someone. We go up to what we mean."

Page 157

But here we're constructing a false contrast between experience and something else, as if experience consisted of sitting still and letting pictures pass in front of one.

Page 157

"When one means, it is oneself doing the meaning"; similarly, it is oneself that does the moving. One rushes forward oneself, and one can't simultaneously observe the rushing. Of course not.

Page 157

Yes, meaning something is like going up to someone.

Page 157

108 Fulfilment of expectation doesn't consist in this: a third thing happens which can be described otherwise than as "the fulfilment of this expectation", i.e. as a feeling of satisfaction or joy or whatever it may be. The expectation that something will be the case is the same as the expectation of the fulfilment of that expectation.

Page 157

Could the justification of an action as fulfilment of an order run like this: "You said 'bring me a yellow flower', upon which this one gave me a feeling of satisfaction; that is why I have brought it"? Wouldn't one have to reply: "But I didn't set you to bring me the flower which should give you that sort of feeling after what I said!"

Page 157

(I go to look for the yellow flower. Suppose that while I am looking a picture comes before my mind,--even so, do I need it when I see the yellow flower--or another flower? If I say: "as soon as I see a yellow flower, something as it were clicks into place in my memory"--rather like a lever into a cog in the striking mechanism of a clock--can I foresee, or expect, this clicking into place any better than the yellow flower? Even if in a particular case

Page Break 158

it really is true that what I'm expecting isn't what I am looking for, but some other (indirect) criterion, that certainly isn't an explanation of expectation.)

Page 158

But isn't the occurrence of what is expected always accompanied by a phenomenon of agreement (or satisfaction?). Is this phenomenon something different from the occurrence of what is expected? If so, then I don't know whether fulfilment is always accompanied by such a phenomenon.

Page 158

If I say: the person whose expectation is fulfilled doesn't have to shout out "yes, that is it" or the like--I may be told: "Certainly, but he must *know* that the expectation is fulfilled." Yes, if the knowledge is part of its *being* fulfilled. "Yes, but when someone has his expectation fulfilled, there's always a relaxation of tension!"--How do you

know that?

Page Break 159

VIII

Page 159

109 A description of language must achieve the same result as language itself. "For in that case I really can learn from the proposition, from the description of reality, how things are in reality."--Of course it's only *this* that is called description, or "learning how things are". And that is all that is ever said when we say that we learn from the description how things are in reality.

Page 159

"From the order you get the knowledge of what you have to do. And yet the order only gives you itself, and its effect is neither here nor there." But here we are simply misled by the form of expression of our language, when it says "the knowledge of *what* you have to do" or "the knowledge of the action". For then it looks as if this something, the action, is a thing which is to come into existence when the order is carried out, and as if the order made us acquainted with this very thing by showing it us in such a way that it already in a certain sense brought it into existence. (How can a command--an expectation--show us a man before he has come into the room?)

Page 159

Suppose someone says that one can infer from an order the action that obeys it, and from a proposition the fact which verifies it. What on earth can one infer from a proposition apart from *itself*? How can one pull the action out of the order before it takes place? Unless what is meant is a different form of description of the action, such as say making a drawing, in accordance with the order, of what I'm to do. But even this further description isn't there until I have drawn it; it doesn't have a shadowy existence in the order itself.

Page 159

Being able to do something seems like a shadow of the actual doing, just as the sense of a sentence seems like the shadow of a fact, and the understanding of an order the shadow of its execution.

Page Break 160

In the order the fact as it were "casts its shadow before it"! But this shadow, whatever it may be, is not the event.

Page 160

The shadowy anticipation of the fact consists in our being able already to think that *that very thing* will happen, which *hasn't yet* happened. Or, as it is misleadingly put, in our being now able to think of (or about) *what hasn't yet* happened.

Page 160

110 Thinking plus its application proceeds step by step like a calculus.--However many intermediate steps I insert between the thought and its application, each intermediate step always follows the previous one without any intermediate link, and so too the application follows the last intermediate step. It is the same as when we want to insert intermediate links between decision and action.

Page 160

The ambiguity of our ways of expressing ourselves: If an order were given us in code with the key for translating in into English, we might call the procedure of constructing the English form of the order "derivation of what we have to do from the code" or "derivation of what executing the order is". If on the other hand we act according to the order, obey it, here too in certain cases one may speak of a derivation of the execution.

Page 160

We can't cross the bridge to the execution until we are there.

Page 160

111 It is as a calculus that thinking has an interest for us; not as an activity of the human imagination.

Page 160

It is the *calculus* of thought that connects with extra-mental reality.

Page 160

From expectation to fulfilment is a step in a calculation. Indeed, the relation between the calculation

$$\begin{array}{r} 25 \times 25 \\ \hline 50 \\ 125 \\ \hline \end{array}$$

and its result 625 is exactly the same as that between expectation

and its fulfilment. Expectation is a picture of its fulfilment to exactly the same degree as this calculation is a picture of its result, and the fulfilment is determined by the expectation to exactly the same degree as the result is determined by the calculation.

112 When I think in language, there aren't meanings going through my mind in addition to the verbal expressions; the language is itself the vehicle of thought.

In what sense does an order anticipate its execution? By ordering *just that* which later on is carried out? But one would have to say "which later on is carried out, or again is not carried out". And that is to say nothing.

"But even if my wish does not determine what is going to be the case, still it does so to speak determine the theme of a fact, whether the fact fulfils the wish or not." We are--as it were--surprised, not at anyone's knowing the future, but at his being able to prophesy at all (right or wrong).

As if the mere prophecy, no matter whether true or false, foreshadowed the future; whereas it knows nothing of the future and cannot know less than nothing.

Suppose you now ask: then are facts defined one way or another by an expectation--that is, is it defined for whatever event may occur whether it fulfils the expectation or not? The answer has to be: Yes, unless the expression of the expectation is indefinite, e.g. by containing a disjunction of different possibilities.

"The proposition determines in advance what will make it true." Certainly, the proposition "p" determines that p must be the case in order to make it true; and that means:

(the proposition p) = (the proposition that the fact p makes true). And the statement that the wish for it to be the case that p is satisfied by the event p, merely enunciates a rule for signs:

(the wish for it to be the case that p) = (the wish that is satisfied by the event p).

Like everything metaphysical the harmony between thought and reality is to be found in the grammar of the language.

IX

113 Here instead of harmony or agreement of thought and reality one might say: the pictorial character of thought. But is this pictorial character an agreement? In the *Tractatus* I had said something like: it is an agreement of form. But that is misleading.

Anything can be a picture of anything, if we extend the concept of picture sufficiently. If not, we have to explain what we call a picture of something, and what we want to call the agreement of the pictorial character, the agreement of the forms.

For what I said really boils down to this: that every projection must have something in common with what is projected no matter what is the method of projection. But that only means that I am here extending the concept of 'having in common' and am making it equivalent to the general concept of projection. So I am only drawing attention to a possibility of generalization (which of course can be very important).

The agreement of thought and reality consists in this: if I say falsely that something is *red*, then, for all that, it isn't *red*. And when I want to explain the word "red" to someone, in the sentence "That is not red", I do it by pointing to something red.

In what sense can I say that a proposition is a picture? When I think about it, I want to say: it must be a picture if it is to show me what I am to do, if I am to be able to act in accordance with it. But in that case all you want to say is that you act in accordance with a proposition in the same sense as you act in accordance with a picture.

To say that a proposition is a picture gives prominence to certain features of the grammar of the word "proposition".

Thinking is quite comparable to the drawing of pictures.

But one can also say that what looks like an analogue of a proposition is actually a particular case of our general concept. When I compared the proposition with a ruler, strictly speaking what I did was to take the use of a ruler in making a statement of length as an example for all propositions.

114 The sense of a proposition and the sense of a picture. If we compare a proposition with a picture, we must think whether we are comparing it to a portrait (a historical representation) or to a genre-picture. And both comparisons have point.

Sentences in fiction correspond to genre-pictures.

"When I look at a genre-picture, it 'tells' me something even though I don't believe (imagine) for a moment that the people I see in it really exist, or that there have really been people in that situation."

Think of the quite different grammar of the expressions:

"This picture shows people in a village inn."

"This picture shows the coronation of Napoleon."

(Socrates: "And if you have an idea must it not be an idea of *something*?"--Theaetetus:

"Necessarily."--Socrates: "And if you have an idea of something, mustn't it be of something real?"--Theaetetus: "It seems so").†1

Does the picture tell me, for instance, "two people are sitting in an inn drinking wine?" Only if this proposition somehow enters into the process of understanding *outside the picture*, say if I say which I look at the picture "here two people are sitting etc." If the picture tells me something in this sense, it tells me *words*. But how far does it declare itself in these words? After all, if reality is declaring itself via language, it is taking a long way round.

So for the picture to tell me something it isn't essential that words should occur to me while I look at it; because the picture was supposed to be the more direct language.

Here it is important to realise that instead of a picture one might have considered a slice of material reality. For although our

attitude to a painted table derives historically from our attitude to real tables, the latter is not a part of the former.

115 So what the picture tells me is itself.

Its telling me something will consist in my recognizing in it objects in some sort of characteristic arrangement. (If I say: "I see a table in this picture" then what I say characterizes the picture--as I said--in a manner which has nothing to do with the existence of a 'real' table. "The picture shows me a cube" can e.g. mean: It contains

the form  .)

Asked "Did you recognize your desk when you entered your room this morning?"--I should no doubt say "Certainly!" and yet it would be misleading to call what took place "a recognition". Certainly the desk was not strange to me; I was not surprised to see it, as I should have been if another one had been standing there, or some

unfamiliar kind of object.

Page 165

"Something is familiar if I know what it is."

Page 165

"What does it mean: 'this object is familiar to me?'--"Well, I know that it's a table." But that can mean any number of things, such as "I know how it's used", "I know it looks like a table when it's opened out", "I know that it's what people call 'a table'."

Page 165

What kind of thing is "familiarity"? What constitutes a view's being familiar to me? (The question itself is peculiar; it does not sound like a grammatical question.)

Page 165

I would like to say: "I see what I see". And the familiarity can only consist in my being at home in what I see.

Page 165

116 "I see what I see": I say that because I don't want to give a name to what I see. I don't want to say "I see a flower" because that

Page Break 166

presupposes a linguistic convention, and I want a form of expression that makes no reference to the history of the impression.

Page 166

The familiarity consists in my recognizing that what I see is a flower. I may say: the utterance of the words "that is a flower" is a recognition reaction; but the criterion for recognition isn't that I name the object correctly, but that when I look at it I utter a series of sounds and have a certain experience. For that the sounds are the correct English word, or that they are a word at all in any existent language, isn't part of my experience during the utterance.

Page 166

I want to exclude from my consideration of familiarity everything that is 'historical'. When that's been done what remains is impressions (experiences, reactions). Even where language does enter into our experience, we don't consider it as an existing institution.

Page 166

So the multiplicity of familiarity, as I understand it, is that of feeling at home in what I see. It might consist in such facts as these: my glance doesn't move restlessly (inquiringly) around the object. I don't keep changing the way I look at it, but immediately fix on one and hold it steady.

Page 166

I see the picture of a heavy coat and have a feeling of warmth and cosiness; I see the picture of a winter landscape and shiver. These reactions, it might be said, are justified by earlier experience. But we aren't concerned *now* about the history of our experiences or about any such justification.

Page 166

No one will say that every time I enter a room, my long familiar surroundings, there is enacted a recognition of all that I see and have seen hundreds of times before.

Page 166

117 If we think of our understanding of a picture, of a genre

Page Break 167

picture say, we are perhaps inclined to assume that there is a particular phenomenon of recognition and that we recognize the painted people as people, the painted trees as trees and so on.

Page 167

But when I look at a genre picture do I compare the painted people with real people etc.?

Page 167

So should I say that I recognize the painted people as painted people? And similarly real people as real people?

Page 167

Of course there is a phenomenon of recognition in a case where it takes some sort of investigation to recognize a drawing as a representation of a human being; but when I see a drawing immediately as the representation of a human being, nothing of that kind happens.

Page 167

A picture of a human face is a no less familiar object than the human face itself. But there is no question of recognition here.

118 It is easy to have a false concept of the processes called "recognizing"; as if recognizing always consisted in comparing two impressions with one another. It is as if I carried a picture of an object with me and used it to perform an identification of an object as the one represented by the picture. Our memory seems to us to be the agent of such a comparison, by preserving a picture of what has been seen before, or by allowing us to look into the past (as if down a spy-glass).

In most cases of recognition no such process takes place.

Someone meets me in the street and my eyes are drawn to his face; perhaps I ask myself "who is that?"; suddenly the face begins to look different in a particular way, "it becomes familiar to me"; I smile, go up to him and greet him by name; then we talk of the past and while we do so perhaps a memory image of him comes before my mind, and I see him in a particular situation.

Perhaps someone will say: if I hadn't kept his image in my memory, I couldn't have recognized him. But here he is either using a metaphor, or expressing a hypothesis.

One might say: "What I saw was memory-laden."

We say: "we couldn't use words at all, if we didn't recognize them and the objects they denote." If (because of a faulty memory) we didn't recognize the colour green for what it is then we couldn't use the word "green". But have we any sort of check on this recognition, so that we know that it is really a recognition? If we speak of recognition, we mean that we recognize something as what, in accordance with other criteria, it is. "To recognize" means "to recognize what *is*".

119 Familiarity gives confirmation to what we see, but not by comparing it with anything else. It gives it a stamp, as it were.

On the other hand I would like to say: "what I see here in front of me is not *any old* shape seen in a particular manner: what I see is my shoes, which I know, and not anything else". But here it is just that two forms of expression fight against each other.

This shape that I see--I want to say--is not simply *a* shape; it is one of the shapes I know; it is a shape marked out in advance. It is one of those shapes of which I already had a pattern in me; and only because it corresponds to such a pattern is it this familiar shape. (I as it were carry a catalogue of such shapes around with me, and the objects portrayed in it *are* the familiar ones.)

But my already carrying the pattern round with me would be only a causal explanation of the present impression. It is like saying: this movement is made as easily as if it had been practised.

And it is not so much as if I were comparing the object with a picture set beside it, but as if the object *coincided* with the picture. So I see only one thing, not two.

120 We say: "This face has a quite *particular* expression", and look perhaps for words to characterise it.

Here it is easy to get into that dead-end in philosophy, where one believes that the difficulty of the task consists in this: our having to describe phenomena that are hard to get hold of, the present experience that slips quickly by, or something of the kind. Where we find ordinary language too crude, and it looks as if we were having to do, not with the phenomena of every-day, but with ones that "easily elude us, and in their coming to be and passing away, produce those others as an average effect".

And here one must remember that all the phenomena that now strike us as so remarkable are the very familiar phenomena that don't surprise us in the least when they happen. They don't strike us as remarkable until we

put them in a strange light by philosophizing.

Page 169

121 "What the picture tells me is itself" is what I want to say. That is, its telling me something consists in *its own* structure, in its own forms and colours.

Page 169

It is as if, e.g. "it tells me something" or "it is a picture" meant: it shows a certain combination of cubes and cylinders.

Page 169

"It tells me something" can mean: it narrates something to me, it is a story.

Page 169

It tells me itself, just as a proposition, a story tells me itself.

Page 169

The concept of a narrative picture is surely like that of a genre picture (or a battle scene). If I wanted to explain what a battle

Page Break 170

scene is, I wouldn't need to refer to any reality outside the picture, I would only have to talk about painted men, painted horses, painted cannon and so on.

Page 170

"The picture tells me something": it uses *words*, so to speak: here are eyes, mouth, nose, hands etc. I am comparing the picture to a combination of linguistic forms.

Page 170

The system of language, however, is not in the category of experience. The experiences characteristic of using the system are not the system. (Compare: the meaning of the word "or" and the or-feeling).

Page 170

"Now, that series of signs tells me something; earlier, before I learnt the language, it said nothing to me". Let us suppose what we mean by that is that the sentence is now read with a particular experience. Certainly, before I learnt the language, that series of signs used not to make the same impression on me. Of course, if we disregard the causal element, the impression is quite independent of the system of language.--And there is something in me that is reluctant to say: the sentence's telling me something is constituted by its making this impression on me.

Page 170

"It's only in a language that something is a proposition" is what I want to say.

Page 170

122 'Language' is only languages, plus things I invent by analogy with existing languages. Languages *are* systems.

Page 170

"A proposition belongs to a language." But that just means: it is units of languages that I call "propositions".

Page 170

But we must pay attention to the *use* of the expression "English language", otherwise we shall ask questions like "What is the language? Is it all the sentences which have so far been spoken? Or the set of rules and words? etc. etc." What is the system? Where is it? What is chess? All the games that have been played? The list of rules?

Page 170

"A *proposition* is a unit of language." "After all, what constitutes

Page Break 171

propositions is the combination of words which might be otherwise combined." But that means: what constitutes propositions *for me*. That is the way I regard language.

Page 171

What *we* want to attend to is the system of language.

Page 171

123 Certainly I read a story and don't give a hang about any system of language. I simply read, have impressions, see pictures in my mind's eye, etc. I make the story pass before me like pictures, like a cartoon story. (Of course I do not mean by this that every sentence summons up one or more visual images, and that that is, say, the purpose of a sentence.)

Page 171

Let us imagine a picture story in schematic pictures, and thus more like the narrative in a language than a series of realistic pictures. Using such a picture-language we might in particular e.g. keep our hold on the course of battles. (Language-game.) And a sentence of our word-language approximates to a picture in this picture language

much more closely than we think.

Page 171

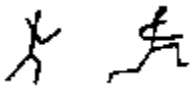
Let us remember too that we don't have to translate  such pictures into realistic ones in order to 'understand' them, any more than we ever translate photographs or film pictures into coloured pictures, although black-and-white men or plants in reality would strike us as unspeakably strange and frightful.

Page 171

Suppose we were to say at this point: "Something is a picture only in a picture-language"?

Page 171

A sentence in a story gives us the same satisfaction as a picture.

Page 171

124 We can on the other hand imagine a language in whose use the impression made on us by the signs played no part; in which there was no question of an understanding, in the sense of such an impression. The signs are e.g. written and transmitted to us and we are able to *take notice of them*. (That is to say, the only impression that comes in here is the pattern of the sign.) If the sign is an order,

Page Break 172

we translate it into action by means of rules, tables. It does not get as far as an impression like that of a picture; nor are stories written in this language. But there is perhaps a kind of reading for entertainment which consists in certain series of signs being translated into bodily movements to make a kind of dance. (Compare the remark about translation and code.)

Page 172

In this case one really might say "the series of signs is *dead* without the system".

Page 172

We could of course also imagine that we had to use rules and translate a verbal sentence into a drawing in order to get an *impression* from it. (That only the picture had a soul.)

Page 172

(I might say to my pupils: When you have been through these exercises you will think differently.)

Page 172

But even in our normal speech we may often quite disregard the impression made by a sentence so that all that is important is how we operate with the sentence (Frege's conception of logic).

Page 172

"There is no such thing as an isolated proposition." For what I call a "proposition" is a position in the game of language.

Page 172

Isn't what misleads us the fact that I can look ever so closely at a position in a game without discovering that it is *a position in a game*? What misleads us here is something in the grammar of the expression "position in a game".

Page 172

Thinking is an activity, like calculating. No one would call calculating, or playing chess, a state.

Page 172

125 Let us imagine a kind of puzzle picture: there is not *one* particular object to find; at first glance it appears to us as a jumble

Page Break 173

of meaningless lines, and only after some effort do we see it as, say, a picture of a landscape.--What makes the difference between the look of the picture before and after the solution? It is clear that we see it differently the two times. But what does it amount to to say that after the solution the picture means something to us, whereas it meant nothing before?

Page 173

We can also put this question like this: What is the general mark of the solution's having been found?

Page 173

I will assume that as soon as it is solved I make the solution obvious by strongly tracing certain lines in the puzzle picture and perhaps putting in some shadows. Why do you call the picture you have sketched in a solution?

Page 173

a) Because it is the clear representation of a group of spatial objects.

Page 173

b) Because it is the representation of a regular solid.

Page 173

c) Because it is a symmetrical figure.

Page 173

d) Because it is a shape that makes an ornamental impression on me.

Page 173

e) Because it is the representation of a body I am familiar with.

Page 173

f) Because there is a list of solutions and this shape (this body) is on the list.

Page 173

g) Because it represents a kind of object that I am very familiar with; for it gives me an instantaneous impression of familiarity, I instantly have all sorts of associations in connexion with it; I know what it is called; I know I have often seen it; I know what it is used for etc.

Page 173

h) Because it represents a face which strikes me as familiar.

Page 173

i) Because it represents a face which I recognize: α) it is the face of my friend so and so; β) it is a face which I have often seen pictures of.

Page 173

k) Because it represents an object which I remember having seen at some time.

Page 173

l) Because it is an ornament that I know well (though I don't remember where I have seen it).

Page Break 174

Page 174

m) Because it is an ornament that I know well; I know its name, I know where I have seen it.

Page 174

n) Because it represents part of the furniture of my room.

Page 174

o) Because I instinctively traced out those lines and now feel easy.

Page 174

p) Because I remember that this object has been described.

Page 174

q) Because I seem to be familiar with the object, a word occurs to me at once as its name (although the word does not belong to any existent language); I tell myself "of course, that is an α such as I have often seen in β ; one γ δ 's with it until they ϵ ." Something of the kind occurs e.g. in dreams.

Page 174

And so on.

Page 174

(Anyone who does not understand why we talk about these things must feel what we say to be mere trifling.)

Page 174

126 The impression is one thing, and the impression's being determinate is another thing. What I call the impression of familiarity is as multifarious as being determinate is.

Page 174

When we look into a human face that we know very well, we need not have any impression, our wits may be completely dull, so to speak; and between that case and a strong impression there are any number of stages.

Page 174

Suppose the sight of a face has a strong effect on us, inspiring us say with fear. Am I to say: first of all there must occur an impression of familiarity, the form of the human face as such must make an impression of familiarity on me, and only then is the impression of fear added to that impression?--Isn't it like this, that what I call the impression of specific familiarity is a characteristic of every strong impression that a face makes on me?--The characteristic, say of determinacy. I did indeed say that the impression of familiarity consists in things like our feeling at home in what we see, in our not changing our way of looking and the like.

Page Break 175

Page 175

127 Can I think away the impression of individual familiarity where it exists; and think it into a situation where it

does not? And what does that mean? I see e.g. the face of a friend and ask myself: what does this face look like if I see it as an unfamiliar face (as if I were seeing it now for the first time)? What remains, as it were, of the look of this face, if I think away, subtract, the impression of familiarity from it? Here I am inclined to say: "It is *very difficult* to separate the familiarity from the impression of the face." But I also feel that this is a misleading way of putting things. For I have no notion how I should so much as try to separate these two things. The expression "to separate them" does not have any clear sense for me.

Page 175

I know what *this means*: "Imagine this table black instead of brown"; it means something like: "paint a picture of this table, but black instead of brown"; or similarly: "draw this man but with longer legs than he has".

Page 175

Suppose someone were to say "Imagine this butterfly exactly as it is, but ugly instead of beautiful"?!

Page 175

"It is very difficult to think away ... ": here it looks as if it was a matter of a psychological difficulty, a difficulty of introspection or the like. (That is true of a large range of philosophical problems: think of the problem of the exact reproduction or description of what is seen in the visual field; of the description of the perpetual flux of phenomena; also of "how many raindrops do you see, if you look at the rain?")

Page 175

Compare: "It is difficult *to will* that table to move from a distance."

Page 175

In this case *we* have not *determined* what thinking the familiarity away is to mean.

Page 175

It might mean, say, to recall the impression which I had when I saw the face for the first time. And here again one must know what it means to "*try*" to remember the impression. For that has several meanings. Let us ask ourselves what activities we call

Page Break 176

"trying to remember something". What do we do if we want to remember what we had for lunch yesterday? Is that method available for the early memories of an adult? Can one *try* to remember one's own birth?

Page 176

I tell myself: I want to try to look at a printed English word and see it as if I hadn't learnt to read, as if the black shapes on the paper were strange drawings whose purpose I couldn't imagine or guess. And then what happens is that I can't look at the printed word without the sound of the word or of the letter I'm actually looking at coming before my mind.

Page 176

For someone who has no knowledge of such things a diagram representing the inside of a radio receiver will be a jumble of meaningless lines. But if he is acquainted with the apparatus and its function, that drawing will be a significant picture for him.

Page 176

Given some solid figure (say in a picture) that means nothing to me at present--can I at will imagine it as meaningful? That's as if I were asked: Can I imagine a body of any old shape as an appliance? But for what sort of use?

Page 176

Well, at any rate one class of corporeal shapes can readily be imagined as dwellings for beasts or men. Another class as weapons. Another as models of landscapes. Etc. etc. So here I know how I can ascribe meaning to a meaningless shape.

Page 176

128 If I say that this face has an expression of gentleness, or kindness, or cowardice, I don't seem just to mean that we associate such and such feelings with the look of the face, I'm tempted to say that the face is itself one aspect of the cowardice, kindness, etc. (Compare e.g. Weininger). It is possible to say: I see cowardice in this face (and might see it in another too) but at all events it doesn't seem to be merely associated, outwardly connected, with the face;

Page Break 177

the fear has the multiplicity of the facial features. And if, for example, the features change slightly, we can speak of a corresponding change in the fear. If we were asked "Can you think of this face as an expression of courage too?"--we should, as it were, not know how to lodge courage in these features. Then perhaps I say "I don't know what it would mean if this is a courageous face." [This sentence cannot be corrected by saying "for this to be a courageous face" instead of "if this is a courageous face"].†1 But what would an answer to such a question be like?

Perhaps one says: "Yes, now I understand: the face as it were shews indifference to the outer world." So we have somehow read courage into the face. Now once more, one might say, courage *fits* this face. But *what* fits *what* here?

Page 177

There is a related case (though perhaps it will not seem so) when for example we (Germans) are surprised that the French do not simply say "the man is good" but put an attributive adjective where there should be a predicative one; and when we solve the problem for ourselves by saying: they mean: "the man is *a good one*".

Page 177

Couldn't different interpretations of a facial expression consist in my imagining each time a different kind of sequel? Certainly that's often how it is. I see a picture which represents a smiling face. What do I do if I take the smile now as a kind one, now as malicious? Don't I imagine it with a spatial and temporal context which I call kind or malicious? Thus I might supply the picture with the fancy that the smiler was smiling down at a child at play, or again on the suffering of an enemy.

Page 177

This is in no way altered by the fact that I can also take the at first sight gracious situation and interpret it differently by putting it into a wider context.--If no special circumstances reverse my interpretation I shall conceive a particular smile as kind, call it a "kind" one, react correspondingly.

Page Break 178

Page 178

That is connected with the contrast between *saying* and *meaning*.

Page 178

"Any expression can lie": but you must think what you mean by "lie". How do you imagine a lie? Aren't you contrasting one expression with another? At any rate, you are contrasting with the expression some other process which might very well be an expression.

Page 178

129 What does it mean: "to *read* kindness *into* the smile"? Perhaps it means: I make a face which is coordinated with the smiling face in a particular way. I coordinate my face to the other one in some such way as to exaggerate one or other of its features.

Page 178

A friendly mouth, friendly eyes. How would one think of a friendly hand? Probably open and not as a fist.--And could one think of the colour of a man's hair as an expression of friendliness or the opposite? Put like that the question seems to ask whether we can *manage* to. The question ought to run: Do we want to call anything a friendly or unfriendly hair-colour? If we wanted to give such words a sense, we should perhaps imagine a man whose hair darkened when he got angry. The reading of an angry expression into dark hair, however, would work *via* a previously existent conception.

Page 178

It may be said: the friendly eyes, the friendly mouth, the wagging of a dog's tail, are among the primary and mutually independent symbols of friendliness; I mean: They are parts of the phenomena that are called friendliness. If one wants to imagine further appearances as expressions of friendliness, one reads these symbols into them. We say: "He has a black look", perhaps because the eyes are more strongly shadowed by the eyebrows; and now we transfer the idea of darkness to the colour of the hair. He has glowering hair. If I were asked whether I could imagine a chair with a friendly expression, it would be above all a friendly *facial expression* I would want to imagine it with; I would want to read a friendly *face* into it.

Page Break 179

Page 179

I say "I can think of this face (which *at first* gives an impression of timidity) as courageous too." We *do not mean* by this that I can imagine someone with this face perhaps saving someone's life (that, of course, is imaginable in connexion with any face). I am speaking rather of an aspect of the face itself. Nor do I mean that I can imagine that this man's face might change so that, in the ordinary sense, it looked courageous; though I may very well mean that there is quite a definite way in which it can change into a courageous face. The reinterpretation of a facial expression can be compared with the reinterpretation of a chord in music, when we hear it as a modulation first into this, then into that key. (Compare also the distinction between mixed colours and intermediary colours).

Page 179

Suppose we ask ourselves "what proper name would suit the character of this man"--and portray it in sound? The method of projection we use for the portrayal is something which as it were stands firm. (A writer might ask

himself what name he wants to give to a person.) But sometimes we project the character into the name that has been given. Thus it appears to us that the great masters have names which uniquely fit the character of their works.

Page 179

Experience of the real size. Suppose we saw a picture showing a chair-shape; we are told it represents a construction the size of a house. Now we see it differently.

Page 179

What happens when we learn to feel the ending of a church mode as an ending?

Page 179

Think of the multifariousness of what we call "language". Word-language, picture-language, gesture-language, sound-language.

Page 179

130 "'This object is familiar to me' is like saying 'this object is portrayed in my catalogue'." In that case it would consist in the fact that it was a picture filed with others in a particular folder, in *this* drawer. But if that really is what I imagine--if I think I simply

Page Break 180

compare the seen object with pictures in my catalogue and find it to agree with one of them--it is something quite unlike the phenomenon of familiarity. That is, we are making the assumption that the picture in our catalogue is itself familiar. If it were something strange, then the fact that it was in this folder, in this drawer, would mean nothing to us.

Page 180

When I speak of a pattern in my mental catalogue, or of a sheath into which an object fits if it is familiar, what I would like to say is that the sheath in my mind is, as it were, the "form of imagining", so that it isn't possible for me to say of a pattern that it is in my mind unless it really is there.--The pattern as it were retires into my mind, so that it is no longer presented to it as an object. But that only means: it didn't make sense to talk of a pattern at all. (The spatial spectacles we can't take off.)

Page 180

If we represent familiarity as an object's fitting into a sheath, that's not quite the same as our *comparing* what is seen with a copy. What we really have in mind is the feeling when the object slips smoothly into the contour of the sheath. But that is a feeling we might have even if there were no such perfectly fitting sheath there at all.

Page 180

We might also imagine that every object had an invisible sheath; that alters nothing in our experience, it is an empty form of representation.

Page 180

It shouldn't really be "Yes, I recognize it, it's a face" but "I recognize it, I see a face". (Here the word face



might mean for me the mere ornament and have no reference to the human face; it might be on a level with any other familiar figure, e.g. a swastika.) For the question is: "What do I recognize *as what*?" For "to recognize a thing as itself" is meaningless.

Page Break 181

Page 181

131 The comparison between memory and a notebook. On the one hand this comparison serves as a picture of the conscious phenomena, and on the other hand it provides a psychological model. (And the word "conscious" is a reference to a chapter of the grammar and is not one side of the psychological contrast between "conscious" and "unconscious".)

Page 181

Many very different things happen when we remember.

Page 181

"Have you been in your room?" "Yes". "Are you sure?" "I would know if I hadn't been here yesterday!" For this I don't need to see myself, even for a moment, in memory in my room. But let's assume that when I said that I saw myself standing at the window in my room; how does the picture show me that it was yesterday? Of course, the picture could show that as well, if for instance I saw in it a wall-calendar with yesterday's date. But if that wasn't the case, how did I read off from the memory image, or from the memory, that I stood thus at the window *yesterday*? How do I translate the experience of remembering into words?--But did I translate an experience into words? Didn't I just utter the words in a particular tone of voice with other experiences of certainty? But wasn't that the experience

of remembering? (The experience of translating is the same kind of thing as the experience of the tone of voice.) But what made you so certain when you spoke those words? Nothing *made* me certain; I *was* certain.

Page 181

Of course, I have other ways of checking--as one might say--what I then uttered. That is: I can now try to remember particular things that happened yesterday and to call up pictures before my mind's eye etc. But certainly that didn't *have* to have happened before I answered.

Page 181

When we narrate a set of events from memory we do sometimes see memory pictures in our mind; but commonly they are only scattered through the memory like illustrations in a story book.

Page 181

Someone says to me "Imagine a patch of the colour called 'red' on this white wall". I do so--shall I now say that I *remembered*

Page Break 182

which colour is called 'red'? When I talk about this table, do I remember that this object is called a 'table'?

Page 182

Mightn't someone object: "So if a man has not learned a language is he unable to have certain memories?" Of course--he cannot have verbal memories, verbal wishes and so on. And memories etc. in language are not mere threadbare representations of the real experiences; for is what is linguistic not an experience? (Words are deeds.)

Page 182

Some men recall a musical theme by having an image of the score rise before them, and reading it off.

Page 182

It could be imagined that what we call "memory" in some man consisted in his seeing himself looking things up in a notebook in spirit, and that what he read in that book was what he remembered. (How do I *react* to a memory?)

Page 182

Incidentally, when I treat the objects around me as familiar, do I think of that comparison? Of course not. I only do so when I look at the act of recognition (individual recognition) after the event; and not so much when I look at it to see what actually happened, as when I look at it through a preconceived schema. (The flux of time.)†1

Page 182

132 If one takes it as obvious that a man takes pleasure in his own fantasies, let it be remembered that fantasy does not correspond to a painted picture, to a sculpture or a film, but to a complicated formation out of heterogeneous components--words, pictures, etc. Then one will not contrast operating with written and spoken

Page Break 183

signs with operating with "imagination-pictures" of events.

Page 183

(The ugliness of a human being can repel in a picture, in a painting, as in reality, but so it can too in a description, in words.)

Page 183

Attitude to a picture (to a thought). The way we experience a picture makes it real for us, that is, connects it with reality; it establishes a continuity with reality.

Page 183

(Fear connects a picture with the terrors of reality.)

Page Break 184

X

Page 184

133 Can an ostensive definition come into collision with the other rules for the use of a word?--It might appear so; but rules can't collide, unless they contradict each other. That aside, it is they that determine a meaning; there isn't a meaning that they are answerable to and could contradict.

Page 184

Grammar is not accountable to any reality. It is grammatical rules that determine meaning (constitute it) and so they themselves are not answerable to any meaning and to that extent are arbitrary.

Page 184

There cannot be a question whether these or other rules are the correct ones for the use of "not" (that is,

whether they accord with its meaning). For without these rules the word has as yet no meaning; and if we change the rules, it now has another meaning (or none), and in that case we may just as well change the word too.

Page 184

"The only correlate in language to an intrinsic necessity is an arbitrary rule. It is the only thing which one can milk out of this intrinsic necessity into a proposition."†1

Page 184

Why don't I call cookery rules arbitrary, and why am I tempted to call the rules of grammar arbitrary? Because I think of the concept "cookery" as defined by the end of cookery, and I don't think of the concept "language" as defined by the end of language. You cook badly if you are guided in your cooking by rules other than the right ones; but if you follow other rules than those of chess you are playing another game; and if you follow grammatical

Page Break 185

rules other than such and such ones, that does not mean you say something wrong, no, you are speaking of something else.

Page 185

If I want to carve a block of wood into a particular shape any cut that gives it the right shape is a good one. But I don't call an argument a good argument just because it has the consequences I want (Pragmatism). I may call a calculation wrong even if the actions based on its result have led to the desired end. (Compare the joke "I've hit the jackpot and he wants to give me lessons!"†1) That shows that the justifications in the two cases are different, and also that "justification" means something different in each case. In the one case one can say "Just wait, you will soon see that it will come out right (i.e. as desired)". In the other case that is no justification.

Page 185

The connection between the rules of cookery and the grammar of the word "cook" is not the same as that between the rules of chess and the expression "play chess" or that between the rules of multiplication and the grammar of the word "multiply".

Page 185

The rules of grammar are arbitrary in the same sense as the choice of a unit of measurement. But that means no more than that the choice is independent of the length of the objects to be measured and that the choice of one unit is not 'true' and of another 'false' in the way that a statement of length is true or false. Of course that is only a remark on the grammar of the word "unit of length".

Page 185

134 One is tempted to justify rules of grammar by sentences like "But there are really four primary colours". And if we say that the

Page Break 186

rules of grammar are arbitrary, that is directed against the possibility of this justification. Yet can't it after all be said that the grammar of colour words characterizes the world as it actually is? One would like to say: May I not really look in vain for a fifth primary colour? (And if looking is possible, then finding is conceivable.) Doesn't grammar put the primary colours together because there is a kind of similarity between them? Or colours, anyway, in contrast to shapes or notes? Or, when I set this up as the right way of dividing up the world, have I a preconceived idea in my head as a paradigm? Of which in that case I can say: "Yes, that is the way we look at things" or "We just do want to form this sort of picture." For if I say "there is a particular similarity among the primary colours"--whence do I derive the idea of this similarity? Just as the idea 'primary colour' is nothing else but 'blue or red or green or yellow' is not the idea of that similarity too given simply by the four colours? Indeed, aren't these concepts the same? (For here it can be said: "what would it be like if these colours did not have this similarity?") (Think of a group containing the four primary colours plus black and white, or the visible colours plus ultraviolet and infrared.)

Page 186

I do not call rules of representation conventions if they can be justified by the fact that a representation made in accordance with them will agree with reality. For instance the rule "paint the sky brighter than anything that receives its light from it" is not a convention.

Page 186

The rules of grammar cannot be justified by shewing that their application makes a representation agree with reality. For this justification would itself have to describe what is represented. And if something can be said in the justification and is permitted by its grammar--why shouldn't it also be permitted by the grammar that I am trying to

justify? Why shouldn't both forms of expression

Page Break 187

have the same freedom? And how could what the one says restrict what the other can say?

Page 187

But can't the justification simply *point* to reality?

Page 187

How far is such pointing a justification? Does it have the multiplicity of a justification? Of course it may be the cause of our saying one sentence rather than another. But does it give a reason for it? Is *that* what we call a justification?

Page 187

No one will deny that studying the nature of the rules of games must be useful for the study of grammatical rules, since it is beyond doubt there is some sort of similarity between them.--The right thing is to let the certain instinct that there is a kinship lead one to look at the rules of games without any preconceived judgement or prejudice about the analogy between games and grammar. And here again one should simply report what one sees and not be afraid that one is undermining a significant and correct intuition, or, on the other hand, wasting one's time with something superfluous.

Page 187

135 One can of course consider language as part of a psychological mechanism. The simplest case is if one uses a restricted concept of language in which language consists only of commands.

Page 187

One can then consider how a foreman directs the work of a group of people by shouting.

Page 187

One can imagine a man inventing language, imagine him discovering how to train other human beings to work in his place, training them through reward and punishment to perform certain tasks when he shouts. This discovery would be like the invention of a machine.

Page 187

Can one say that grammar describes language? If we consider language as part of the psycho-physical mechanism which we use

Page Break 188

when we utter words--like pressing keys on a keyboard--to make a human machine work for us, then we can say that grammar describes that part of the machine. In that case a correct language would be one which would stimulate the desired activities.

Page 188

Clearly I can establish by experience that a human being (or animal) reacts to one sign as I want him to, and to another not. That e.g. a human being goes to the right at the sign "→" and goes to the left at the sign "←"; but that

he does not react to the sign "" as to "←".

Page 188

I do not even need to fabricate a case, I have only to consider what is in fact the case; namely, that I can direct a man who has learned only German, only by using the German language. (For here I am looking at learning German as adjusting (conditioning) a mechanism to respond to a certain kind of influence; and it may be all one to us whether someone else has learned the language, or was perhaps from birth constituted to react to sentences in German like a normal person who has learned it.)

Page 188

Suppose I now made the discovery that someone would bring me sugar at a sign plus the cry "Su", and would bring me milk at a sign and the cry "Mi", and would not do so in response to other words. Should I say that this shows that "Su" is the correct (the only correct) sign for sugar, "Mi" the correct sign for milk?

Page 188

Well, if I say that, I am not using the expression "sign for sugar" in the way it is ordinarily used or in the way I intended to use it.

Page 188

I do not use "that is the sign for sugar" in the same way as the sentence "if I press this button, I get a piece of sugar".

Page 188

136 All the same, let us compare grammar with a system of buttons, a keyboard which I can use to direct a man or a

machine by pressing

Page Break 189

different combinations of keys. What corresponds in this case to the grammar of language?

Page 189

It is easy to construct such a keyboard, for giving different "commands" to the machine. Let's look at a very simple one: it consists of two keys, the one marked "go" and the other "come". Now one might think it must obviously be a rule of the grammar that the two keys shouldn't be depressed simultaneously (that would give rise to a contradiction). But what does happen if we press them both at the same time? Am I assuming that this has an effect? Or that it has no effect? In each case I can designate the effect, or the absence of an effect, as the point and sense of the simultaneous depression of both keys.

Page 189

Or: When I say that the orders "Bring me sugar" and "Bring me milk" make sense, but not the combination "Milk me sugar", that does not mean that the utterance of this combination of words has no effect. And if its effect is that the other person stares at me and gapes, I don't on that account call it the order to stare and gape, even if *that* was precisely the effect that I wanted to produce.

Page 189

"This combination of words makes no sense" does not mean it has no effect.

Page 189

Not even "it does not have the desired effect".

Page 189

137 To say "This combination of words makes no sense" excludes it from the sphere of language and thereby bounds the domain of language. But when one draws a boundary it may be for various kinds of reasons. If I surround an area with a fence or a line or otherwise, the purpose may be to prevent someone from getting in or out; but it may also be part of a game, and the players be supposed, say, to jump over the boundary; or it may show where A's property ends and B's begins; and so on. So if I draw a boundary line that is not yet to say what I am drawing it for.

Page Break 190

Page 190

Language is not defined for us as an arrangement fulfilling a definite purpose. Rather "language" is for me a name for a collection and I understand it as including German, English, and so on, and further various systems of signs which have more or less affinity with these languages.

Page 190

Language is of interest to me as a phenomenon and not as a means to a particular end.

Page 190

138 Grammar consists of conventions. An example of such conventions be one saying "the word 'red' means this colour". Such a convention may be included say in a chart.--Well, now, how could a convention find a place in a mechanism (like the works of a pianola?) Well, it is quite possible that there is a part of the mechanism which resembles a chart, and is inserted between the language-like part of the mechanism and the rest of it.

Page 190

Of course an ostensive definition of a word sets up a connection between a word and 'a thing', and the purpose of this connection may be that the mechanism of which our language is a part should function in a certain way. So the definition can make it work properly, like the connection between the keys and the hammers in a piano; but the connection doesn't consist in the hearing of the words now having *this* effect, since the effect may actually be caused by the making of the convention. And it is the connection and not the effect which determines the meaning.

Page 190

When someone is taught language, does he learn at the same time what is sense and nonsense? When he uses language to what extent does he employ grammar, and in particular the distinction between sense and nonsense?

Page Break 191

Page 191

When someone learns musical notation, he is supplied with a kind of grammar. This is to say: this note corresponds to this key on the piano, the sign \sharp sharpens a note, the sign \natural cancels the \sharp etc. etc. If the



pupil asked whether there was a distinction between

and

or what the sign



meant, we would tell him that the distance between the top of the note and the staff didn't mean anything, and so on. One can view this instruction as part of the preparation that makes the pupil into a playing-machine.

Page 191

So he can speak of a grammar in the case where a language is taught to a person by a mere drill? It is clear that if I want to use the word "grammar" here I can do so only in a "degenerate" sense, because it is only in a degenerate sense that I can speak of "explanation", or of "convention".

Page 191

And a trained child or animal is not acquainted with any problems of philosophy.

Page 191

139 When I said that for us a language was not something that achieved a particular end, but a concept defined by certain systems we call "languages" and such systems as are constructed by analogy with them--I could also have expressed the same thing in the following way: causal connections in the mechanism of language are things that I don't scruple to *invent*.

Page 191

Imagine that someone were to explain "Language is whatever one can use to communicate". What constitutes communication? To complete the explanation we should have to describe what happens when one communicates; and in the process certain causal connections and empirical regularities would come out. But these are just the things that wouldn't interest me; they are the kinds of

Page Break 192

connection I wouldn't hesitate to make up. I wouldn't call just anything that opened the door a "key-bit", but only something with a particular form and structure.

Page 192

"Language" is a word like "keyboard". There are machines which have keyboards. For some reason or other I might be interested in forms of keyboard (both ones in actual use and others merely devised by myself). And to invent a keyboard might mean to invent something that had the desired effect; or else to devise new forms which were similar to the old ones in various ways.

Page 192

"It is always for living beings that signs exist, so that must be something essential to a sign." Yes, but how is a "living" being defined? It appears that here I am prepared to use its capacity to use a sign-language as a defining mark of a living being.

Page 192

And the concept of a living being really has an indeterminacy very similar to that of the concept "language".

Page 192

140 To invent a language could mean to invent an instrument for a particular purpose on the basis of the laws of nature (or consistently with them); but it also has the other sense, analogous to that in which we speak of the invention of a game.

Page 192

Here I am stating something about the grammar of the word "language" by connecting it with the grammar

of the word "invent".

Page 192

Are the rules of chess arbitrary? Imagine that it turned out that only chess entertained and satisfied people. Then the rules aren't arbitrary if the purpose of the game is to be achieved.

Page 192

"The rules of a game are arbitrary" means: the concept 'game' is not defined by the effect the game is supposed to have on us.

Page Break 193

Page 193

There is an analogous sense in which it is arbitrary which unit of measurement we use to express a length, and another sense in which the choice of units is limited or determined.

Page 193

For us language is a calculus; it is characterized by *linguistic activities*.

Page 193

Where does language get its significance? Can we say "Without language we couldn't communicate with one another"? No. It's not like "without the telephone we couldn't speak from Europe to America". We can indeed say "without a mouth human beings couldn't communicate with each other". But the concept of language *is contained in* the concept of communication.

Page 193

141 Is philosophy a creation of word-language? Is word-language a necessary condition for the existence of philosophy? It would be more proper to ask: is there anything like philosophy outside the region of our word-languages? For philosophy isn't anything except philosophical problems, the particular individual worries that we call "philosophical problems". Their common element extends as far as the common element in different regions of our language.

Page 193

Let us consider a particular philosophical problem, such as "How is it possible to measure a period of time, since the past and the future aren't present and the present is only a point?" The characteristic feature of this is that a confusion is expressed in the form of a question that doesn't acknowledge the confusion, and that what *releases* the questioner from his problem is a particular alteration of his method of expression.

Page 193

I could imagine an organ whose stops were to be operated by keys distributed among the keys of the manual which looked exactly like them. There might then arise a philosophical problem: "How are silent notes possible?" And the problem would be

Page Break 194

solved by someone having the idea of replacing the stop-keys by stops which had no similarity with the note-keys.

Page 194

A problem or worry like a philosophical one might arise because someone *played* on all the keys of the manual, and the result didn't sound like music, and yet he was tempted to think that it must be music etc.

Page 194

(Something that at first sight looks like a sentence and is not one.)

Page 194

The following design for the construction of a steam roller was shown to me and seems to be of philosophical interest. The inventor's mistake is akin to a philosophical mistake. The invention consists of a motor inside a hollow roller. The crank-shaft runs through the middle of the roller and is connected at both ends by spokes with the wall of the roller. The cylinder of the petrol-engine is fixed onto the inside of the roller. At first glance this construction looks like a machine. But it is a rigid system and the piston cannot move to and fro in the cylinder. Unwittingly we have deprived it of all possibility of movement.

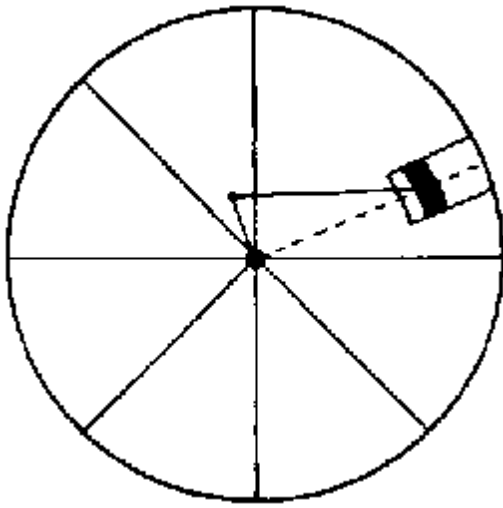

Page 194
 142 "Could a language consist simply of independent signals?" Instead of this we might ask: Are we willing to call a series of independent signals "a language"? To the question "can such a language achieve the same as one which consists of sentences, or combinations of signs?" one would have to answer: it is *experience*

Page Break 195
 that will show us whether e.g. these signals have the same effect on human beings as sentences. But the effect is of no interest to us; we are looking at the phenomenon, the calculus of language.

Page 195
 Imagine something like a diary kept with signals. One side is divided into sections for the hours of the day, like a timetable. The sign "A" means: I am sleeping; "B" means "I am working"; "C" I am eating, etc. etc. But now the question is: are explanations like this given, so that the signals are connected to another language? Is the signal-language supplemented with ostensive definitions of the signals? Or is the language really only to consist of the signs A, B, C etc.?

Page 195
 Suppose someone asked: "how do you know, that you are now doing the same as you were an hour ago?", and I answered: "I wrote it down, yes, here there's a 'C'"--Can one ask whether the sign "A" always means the same? In what circumstances can this question be answered one way or the other? (One can imagine a language in which the words, the names of the colours, say, changed their meanings with the day of the week; this colour is called "red" on Monday, "blue" on Tuesday. "A = A" might say that in the language to which this rule applies there is no change in the meaning of the sign "A".)

Page 195
 Imagine again a language consisting of commands. It is to be used to direct the movements of a human being; a command specifies the distance, and adds one of the words "forwards", "backwards", "right" and "left" and one of the words "fast" and "slowly". Now of course all the commands which will actually be used to direct the movements of a human being; a command such signals in the first place as abbreviations of the sentences of the first language, perhaps translating them back into it before obeying them, and then later on act immediately in response to the signals.--In that case we might speak of two languages and say the first was more pictorial than the second. That is, we wouldn't

Page Break 196
 say that a series of such signals by itself would enable me to *derive* a picture of the movement of a man obeying them unless in addition to the signal there is something that might be called a general rule for translating into drawing. We wouldn't say: from the sign a b b c d you can *derive* the figure

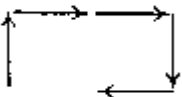

but we would say that you can derive it from a b b c d plus the table

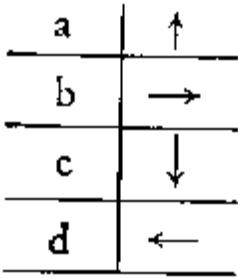

Page 196

We can say: the grammar *explains* the meaning of the signs and thus makes the language pictorial.

Page 196

I can justify the choice of a word by a grammar. But that doesn't mean that I do, or have to, use definitions to justify the words I use in a description or something similar.

Page 196

A comparable case is when ordinary grammar completes an elliptical sentence, and so takes a particular construction as an abbreviated *sentence*.

Page Break 197

Appendix

Page 197

Page Break 198

Page Break 199

1:

Complex and Fact

Page 199

The use of the words 'fact' and 'act'--'That was a noble act.'--'But, that never happened.'--

Page 199

It is natural to want to use the word 'act' so that it only corresponds to a *true* proposition. So that we then don't talk of an act which was never performed. But the proposition 'That was a noble act' must still have a sense even if I am mistaken in thinking that what I call an act occurred. And that of itself contains all that matters, and I can only make the stipulation that I will only use the words 'fact', 'act' (perhaps also 'event') in a proposition which, when complete, asserts that this fact obtains.

Page 199

It would be better to drop the restriction on the use of these words, since it only leads to confusion, and say quite happily: 'This act was never performed', 'This fact does not obtain', 'This event did not occur'.

Page 199

Complex is not like fact. For I can, e.g., say of a complex that it moves from one place to another, but not of a fact.

Page 199

But that this complex is now situated here is a fact.

Page 199

'This complex of buildings is coming down' is tantamount to: 'The buildings thus grouped together are coming down'.

Page 199

I call a flower, a house, a constellation, complexes: moreover, complexes of petals, bricks, stars etc.

Page 199

That this constellation is located here, can of course be described by a proposition in which only its stars are mentioned and neither the word 'constellation' nor its name occurs.

Page 199

But that is all there is to say about the relation between complex

Page Break 200

and fact. And a complex is a spatial object, composed of spatial objects. (The concept 'spatial' admitting of a certain extension.)

Page 200

A complex is composed of its parts, the things of a kind which go to make it up. (This is of course a grammatical proposition concerning the words 'complex', 'part' and 'compose'.)

Page 200

To say that a red circle is *composed* of redness and circularity, or is a complex with these component parts, is a misuse of these words and is misleading. (Frege was aware of this and told me.)

Page 200

It is just as misleading to say the fact that this circle is red (that I am tired) is a complex whose component parts are a circle and redness (myself and tiredness).

Page 200

Neither is a house a complex of bricks and their spatial relations. i.e. that too goes against the correct use of the word.

Page 200

Now, you can of course point at a constellation and say: this constellation is composed entirely of objects with which I am already acquainted; but you can't 'point at a fact' and say this.

Page 200

'To describe a fact', or 'the description of a fact', is also a misleading expression for the assertion stating that the fact obtains, since it sounds like: 'describing the animal that I saw'.

Page 200

Of course we also say: 'to point out a fact', but that always means; 'to point out the fact that...'. Whereas 'to point at (or point out) a flower' doesn't mean to point out that this blossom is on this stalk; for we needn't be talking about this blossom and this stalk at all.

Page 200

It's just as impossible for it to mean: to point out the fact that this flower is situated there.

Page 200

To point out a fact means to assert something, to state something. 'To point out a flower' doesn't mean this.

Page Break 201

Page 201

A chain, too, is composed of its links, not of these and their spatial relations.

Page 201

The fact that these links are so concatenated, isn't '*composed*' of anything at all.

Page 201

The root of this muddle is the confusing use of the word 'object'.

Page 201

The part is smaller than the whole: applied to fact and component part (constituent), that would yield an absurdity.

Page 201

The schema: thing-property. We say that actions have properties, like swiftness, or goodness.

Page Break 202

2:

Concept and Object, Property and Substrate

Page 202

When Frege and Russell talk of concept and object they really mean property and thing; and here I'm thinking in particular of a spatial body and its colour. Or one can say: concept and object are the same as predicate and subject. The subject-predicate form is one of the forms of expression that occur in human languages. It is the form "x is y" (" $x \in y$ "): "My brother is tall", "The storm is nearby", "This circle is red", "Augustus is strong", "2 is a number", "This thing is a piece of coal".

Page 202

The concept of a material point in physics is an abstraction from the material objects of experience; in the same way the subject-predicate form of logic is an abstraction from the subject-predicate form of our languages. The pure subject-predicate form is supposed to be $a \in f(x)$, where "a" is the name of an object. Now let's look for an application of this schema. The first things that come to mind as "names of objects" are the names of persons and of other spatial objects (the Koh-i-Noor). Such names are given by ostensive definitions ("that  is called 'N'"). Such a definition might be conceived as a rule substituting the word "N" for a gesture pointing to the object, with the proviso that the gesture can always be used in place of the name. Thus, I may have explained "this man is called 'N'", and I go on to say "'N' is a mathematician", "N is lazy", and in each of these sentences I might have said "this man"

(with the ostensive gesture) instead of "N". (In that case, incidentally it would have been better to phrase the ostensive definition "this man is called 'N'"†1 or "I want to call this man 'N'", because the version above is also the proposition that this man bears this name).

Page 202

However, this isn't the normal way of using a name; it is an essential feature of the normal use that I can't fall back on to a sign of the gesture language in place of the name. That's to say, in the way in which we use the name "N", if N goes out of the room and later a man comes into the room it makes sense to ask whether

Page Break 203

this man is N, whether he is the same man as the one who left the room earlier. And the sentence "N has come back into the room" only makes sense if I can decide the question. And its sense will vary with the criterion for this being the object that I earlier called 'N'. Different kinds of criteria will make different rules hold for the sign 'N', will make it a 'name' in a different sense of the word. Thus the word 'name' and the corresponding word 'object' are each headings to countless different lists of rules.

Page 203

If we give names to spatial objects, our use of such names depends on a criterion of identity which presupposes the impenetrability of bodies and the continuity of their movement. So if I could treat two bodies A and B as I can treat their shadows on the wall, making two into one and one into two again, it would be senseless to ask which of the two after the division is A and which is B, unless I go on to introduce a totally new criterion of identity e.g. the direction of their movements. (There is a rule for the name of a river arising from the confluence of two rivers, thus:

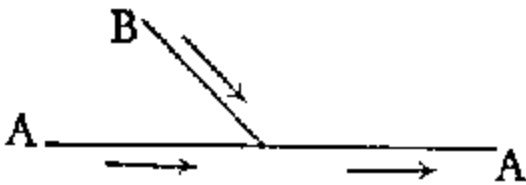

The resulting river takes the name of that source in whose approximate direction it flows onward.)

Page 203

Think of the possible criteria of identity for things like colour patches in my visual field (or figures on a cinema screen) and of the different kinds of use of names given to such patches or figures.

Page 203

If we turn to the form of expression " $(\exists x).fx$ " it's clear that this is a sublimation of the form of expression in our language: "There are human beings on this island" "There are stars that we do not see". To every proposition of the form " $(\exists x).fx$ " there is supposed to correspond a proposition "fa", and "a" is supposed to be a name. So one must be able to say " $(\exists x).fx$, namely a and b",

Page Break 204

("There are some values of x, which satisfy fx, namely a and b"), or " $(\exists x).fx$, e.g. a", etc. And this is indeed possible in a case like "There are human beings on this island, namely Messrs A, B, C, D." But then is it essential to the sense of the sentence "There are men on this island" that we should be able to name them, and fix a particular criterion for their identification? That is only so in the case where the proposition " $(\exists x).fx$ " is defined as a disjunction of propositions of the form "f(x)", if e.g. it is laid down that "There are men on this island" means "Either Mr. A or Mr. B or Mr. C or Mr. D. or Mr. E is on this island"--if, that is, one determines the concept "man" extensionally (which of course is quite contrary to the normal use of this word.) (On the other hand the concept "primary colour" really is determined extensionally.)

Page 204

So it doesn't always make sense when presented with a proposition " $(\exists x).fx$ " to ask "Which xs satisfy f?" "Which red circle a centimetre across is in the middle of this square?"--One mustn't confuse the question "which object satisfies f?" with the question "what sort of object... etc.?" The first question would have to be answered by a name, and so the answer would have to be able to take the form "f(a)"; the question "what sort of...?" is answered by " $(\exists x).fx.\phi x$ ". So it may be senseless to ask "which red spot do you see?" and yet make sense to ask "what kind of a red spot do you see (a round one, a square one, etc.)?"

Page 204

I would like to say: the old logic contains more convention and physics than has been realised. If a noun is

the name of a *body*, a verb is to denote a movement, and an adjective to denote a property of a body, it is easy to see how much that logic presupposes; and it is reasonable to conjecture that those original presuppositions go still deeper into the application of the words, and the logic of propositions.

Page 204

(Suppose we were set the task of projecting figures of various shapes on a given plane I into a plane II. We could then fix a

Page Break 205

method of projection (say orthogonal projection) and carry out the mapping in accordance with it. We could also easily make inferences from the representations on plane II about the figures on plane I. But we could also adopt another procedure: we might decide that the representations in the second plane should all be circles, no matter what the copied figures in the first plane might be. (Perhaps this is the most convenient form of representation for us.) That is, different figures on I are mapped onto II by different methods of projection. In order in this case to construe the circles in II as representations of the figures in I, I shall have to give the method of projection for each circle; the mere fact that a figure in I is represented as a circle in II†1 by itself tells us nothing about the shape of the figure copied. That an image in II is a circle is just the established norm of our mapping.--Well, the same thing happens when we depict reality in our language in accordance with the subject-predicate form. The subject-predicate form serves as a projection of countless different logical forms.

Page 205

Frege's "Concept and Object" is the same as subject and predicate.

Page 205

If a table is painted brown, then it's easy to think of the wood as bearer of the property brown and you can imagine what remains the same when the colour changes. Even in the case of *one* particular circle which appears now red, now blue. It is thus easy to imagine *what* is red, but difficult to imagine what is circular. What *remains* in this case if form and colour alter? For position is part of the form and it is arbitrary for me to lay down that the centre should stay fixed and the only changes in form be changes in the radius.

Page 205

We must once more adhere to ordinary language and say that a *patch* is circular.

Page 205

It is clear that here the phrase "bearer of a property" in this context conveys a completely wrong--an impossible--picture. If I have a lump of clay, I can consider it as the bearer of a form, and that, roughly, is where this picture comes from.

Page Break 206

Page 206

"The patch changes its form" and "the lump of clay changes its form" are different forms of propositions.

Page 206

You can say "Measure whether *that* is a circle" or "See whether *that* over there is a hat". You can also say "Measure whether that is a circle or an ellipse", but not "... whether that is a circle or a hat"; nor "See whether that is a hat or red".

Page 206

If I point to a curve and say "That is a circle" then someone can object that if it were not a circle it would no longer be *that*. That is to say, what I mean by the word "that" must be independent of what I assert about it.

Page 206

("Was *that* thunder, or gunfire?" Here you could not ask "Was that a noise?")

Page 206

How are two circles of the same size distinguished? This question makes it sound as if they were pretty nearly one circle and only distinguished by a nicety.

Page 206

In the technique of representation by equations what is common is expressed by the form of the equation, and the difference by the difference in the coordinates of the centres.

Page 206

So it is as if what corresponds with the objects falling under the concept were here the coordinates of the centres.

Page 206

Couldn't you then say, instead of "This is a circle", "This point is the centre of a circle"? For to be the centre

of a circle is an external property of the point.

Page 206

What is necessary to a description that--say--a book is in a certain position? The internal description of the book, i.e. of the concept, and a description of its place which it would be possible to give by giving the co-ordinates of three points. The proposition "Such a book is *here*" would mean that it had *these* three co-ordinates. For the specification of the "here" must not prejudge *what* is here.

Page 206

But doesn't it come to the same thing whether I say "*This* is a book" or "Here is a book"? The proposition would then amount

Page Break 207

to saying, "These are three corners of such a book".

Page 207

Similarly you can also say "This circle is the projection of a sphere" or "This is a man's appearance".

Page 207

All that I am saying comes to this, that $\Phi(x)$ must be an *external* description of x .

Page 207

If in this sense I now say in three-dimensional space "Here is a circle" and on another occasion "Here is a sphere" are the two "here's" of the same type? I want to ask: can one significantly say of the same 'object': it is a circle, and: it is a sphere? Is the subject of each of these predicates of the same type? Both could be the three coordinates of the relevant centre-point. But the position of the circle in three-dimensional space is not fixed by the coordinates of its centre.

Page 207

On the other hand you can of course say "It's not the noise, but the colour that makes me nervous" and here it might look as if a variable assumed a colour and a noise as values. ("Sounds and colours can be used as vehicles of communication".) It is clear that this proposition is of the same kind as "if you hear a shot, or see me wave, run". For this is the kind of co-ordination on the basis of which a heard or seen language functions.

Page 207

"Is it conceivable that two things have all their properties in common?"--If it isn't conceivable, then neither is its opposite.

Page 207

We do indeed talk about a circle, its diameter, etc. etc., as if we were describing a concept in complete abstraction from the objects falling under it.--But in that case 'circle' is not a predicate in the original sense. And in general geometry is the place where concepts from the most different regions get mixed up together.

Page Break 208

3: *Objects*

Page 208

"In a certain sense, an object cannot be described." (So too Plato: "You can't give an account of one but only name it.") Here "object" means "reference of a not further definable word", and "description" or "explanation" really means: "definition". For of course it isn't denied that the object can be "described from outside", that properties can be ascribed to it and so on.

Page 208

So when we use the proposition above we are thinking of a calculus with signs or names that are indefinable--or, more accurately, undefined--and we are saying that no account can be given of them.

Page 208

"What a word means a proposition cannot tell."

Page 208

What is the distinction, then, between blue and red?

Page 208

We aren't of the opinion that one colour has one property and the other another. In any case, the properties of blue and red are that this body (or place) is blue, and that other is red.

Page 208

When asked "what is the distinction between blue and red?" we feel like answering: one is blue and the other red. But of course that means nothing and in reality what we're thinking of is the distinction between the surfaces or places that have these colours. For otherwise the question makes no sense at all.

Compare the different question: "What is the distinction between orange and pink?" One is a mixture of yellow and red, the other a mixture of white and red. And we may say accordingly: blue comes from purple when it gets more bluish, and red comes from purple when that gets more and more reddish.

So what I am saying means: red can't be described. But can't we represent it in painting by painting something red?

No, that isn't a representation in painting of the meaning of the word 'red' (there's no such thing).

The portrait of red.

Still, it's no accident that in order to define the meaning of the word "red" the natural thing is to point to a red object.

(What is natural about it is portrayed in that sentence by the double occurrence of the word 'red').

To say that blue is on the bluish side of blue-red and red on the reddish side is a grammatical sentence and therefore akin to a definition. And indeed one can also say: more bluish = more like blue.

"If you call the colour green an object, you must be saying that it is an object that occurs in the symbolism. Otherwise the sense of the symbolism, and thus its very existence as a symbolism, would not be guaranteed."

But what does that assert about green, or the word "green"? ((That sentence is connected with a particular conception of the meaning-relation and a particular formulation of the problem the relation raises)).

4:
Elementary Propositions
A†1

Can a logical product be hidden in a proposition? And if so, how does one tell, and what methods do we have of bringing the hidden element of a proposition to light? If we haven't yet got a method, then we can't speak of something being hidden or possibly hidden. And if we do have a method of discovery then the only way in which something like a logical product can be hidden in a proposition is the way in which a quotient like $753/3$ is hidden until the division has been carried out.

The question whether a logical product is hidden in a sentence is a mathematical problem.

So an elementary proposition is a proposition which, in the calculus as I am now using it, is not represented as a truth-function of other sentences.

The idea of constructing elementary propositions (as e.g. Carnap has tried to do) rests on a false notion of logical analysis. It is not the task of that analysis to discover a *theory* of elementary propositions, like discovering principles of mechanics.

My notion in the *Tractatus Logico-Philosophicus* was wrong: 1) because I wasn't clear about the sense of the words "a logical product is *hidden* in a sentence" (and suchlike), 2) because I too thought that logical analysis had to bring to light what was hidden (as chemical and physical analysis does).

The proposition "this place is now red" (or "this circle is now red") can be called an elementary proposition if this means that it is

neither a truth-function of other propositions nor defined as such. (Here I am disregarding combinations such as $p : q \vee \sim q$ and the like.)

Page 211

But from "a is now red" there follows "a is now not green" and so elementary propositions in this sense aren't independent of each other like the elementary propositions in the calculus I once described--a calculus to which, misled as I was by a false notion of reduction, I thought that the whole use of propositions must be reducible.

B†1

Page 211

If you want to use the appellation "elementary proposition" as I did in the *Tractatus Logico-Philosophicus*, and as Russell used "atomic proposition", you may call the sentence "Here there is a red rose" an elementary proposition. That is to say, it doesn't contain a truth-function and it isn't defined by an expression which contains one. But if we're to say that a proposition isn't an elementary proposition unless its complete logical analysis shows that it isn't built out of other propositions by truth-functions, we are presupposing that we have an idea of what such an 'analysis' would be. Formerly, I myself spoke of a 'complete analysis', and I used to believe that philosophy had to give a definitive dissection of propositions so as to set out clearly all their connections and remove all possibilities of misunderstanding. I spoke as if there was a calculus in which such a dissection would be possible. I vaguely had in mind something like the definition that Russell had given for the definite article, and I used to think that in a similar way one would be able to use visual impressions etc. to define the concept say of a sphere, and thus exhibit once for all the connections between the concepts and lay bare the source of all misunderstandings, etc. At the root of all this there was a false and idealized picture of the use of language. Of course, in particular cases one can

Page Break 212

clarify by definitions the connections between the different types of use of expressions. Such a definition may be useful in the case of the connection between 'visual impression' and 'sphere'. But for this purpose it is not a definition of the concept of a physical sphere that we need; instead we must describe a language game related to our own, or rather a whole series of related language games, and it will be in these that such definitions may occur. Such a contrast destroys grammatical prejudices and makes it possible for us to see the use of a word as it really is, instead of *inventing* the use for the word.

Page 212

There could perhaps be a calculus for dissecting propositions; it isn't hard to imagine one. Then it becomes a problem of calculation to discover whether a proposition is or is not an elementary proposition.

Page 212

The question whether e.g. a logical product is hidden in a sentence is a mathematical problem.--What "hidden" means here is defined by the method of discovery (or, as it might be, by the lack of a method).

Page 212

.....

What gives us the idea that there is a kind of agreement between thought and reality?--Instead of "agreement" here one might say with a clear conscience "pictorial character".†1

Page 212

But is this pictorial character an agreement? In the *Tractatus Logico-Philosophicus* I said something like: it is an agreement of form. But that is an error.

Page 212

First of all, "picture" here is ambiguous. One wants to say that an order is the picture of the action which was carried out on the order; but also, a picture of the action which *is to be* carried out as an order.

Page Break 213

Page 213

We may say: a blueprint *serves as a picture* of the object which the workman is to make from it.

Page 213

And here we might call the way in which the workman turns such a drawing into an artefact "the method of projection". We might now express ourselves thus: the method of projection mediates between the drawing and the object, it reaches from the drawing to the artefact. Here we are comparing the method of projection with projection lines which go from one figure to another.--But if the method of projection is a bridge, it is a bridge which isn't built until the application is made.--This comparison conceals the fact that the picture *plus* the projection lines leaves open

various methods of application; it makes it look as if what is depicted, even if it does not exist in fact, is determined by the picture and the projection lines in an ethereal manner; every bit as determined, that is to say, as if it did exist. (It is 'determined give or take a yes or no.') In that case what we may call 'picture' is the blueprint plus the method of its application. And we now imagine the method as something which is attached to the blueprint whether or not it is used. (One can "*describe*" an application even if it doesn't exist).†1

Page 213

Now I would like to ask "How can the blueprint be used as a representation, unless there is already an agreement with what is to be made?"--But what does that mean? Well, perhaps this: how could I play the notes in the score on the piano if they didn't already have a relationship to particular types of movement of the hand? Of course such a relationship *sometimes* consists in a certain agreement, but sometimes not in any agreement, but merely in our having learnt to apply the signs in a particular way. What the comparison between the method of projection and the projection lines connecting the picture with the object does is to make all these cases alike--because *that* is what attracts us. You may say: I count the projection lines as part of the picture--but not the method of projection.

Page Break 214

Page 214

You may of course also say: I count a *description* of a method of projection as part of the picture.

Page 214

So I am imagining that the difference between proposition and reality is ironed out by the lines of projection belonging to the picture, the thought, and that no further room is left for a method of application, but only for agreement and disagreement.

Page Break 215

5:

*Is time essential to propositions?
Comparison between time and truth-functions*

Page 215

If we had grammar set out in the form of a book, it wouldn't be a series of chapters side by side, it would have quite a different structure. And it is here, if I am right, that we would have to see the distinction between phenomenological and non-phenomenological. There would be, say, a chapter about colours, setting out the rules for the use of colour-words; but there would be nothing comparable in what the grammar had to say about the words "not", "or", etc. (the "logical constants").

Page 215

It would, for instance, be a consequence of the rules, that these latter words unlike the colour words were usable in every proposition; and the generality belonging to this "every" would not be the kind that is discovered by experience, but the generality of a supreme rule of the game admitting of no appeal.

Page 215

How does the temporal character of facts manifest itself? How does it express itself, if not by certain expressions having to occur in our sentences? That means: how does the temporal character of facts express itself, if not grammatically? "Temporal character"--that doesn't mean that I come at 5 o'clock, but that I come at some time or other, i.e. that my proposition has the structure it has.

Page 215

We are inclined to say that negation and disjunction are connected with the nature of the proposition, but that time is connected with its content rather than with its nature.

Page 215

But if two things are equally universal, how can it show itself in grammar that one of them is connected with the nature of the proposition and the other is not?

Page 215

Or should I have said that time is not equally universal since mathematical propositions can be negated and occur in disjunctions, without being temporal? There is indeed a connection here, though this form of portraying the matter is misleading.

Page Break 216

Page 216

But that shows what I mean by "proposition." or "nature of the proposition".

Page 216

Why--I want to ask--is the temporal character of propositions so universal?

Page 216

Might one also put the question thus: "How does it happen that every fact of experience can be brought into a relationship with what is shown by a clock?"

Page 216

Having two kinds of generality in the way I spoke of would be as strange as if there were two equally exceptionless rules of a game and one of them were pronounced to be more fundamental. As if one could ask whether in chess the king or the chess board was more important; which of the two was more essential, and which more accidental.

Page 216

There's at least one question that seems in order: suppose I had written up the grammar, and the different chapters on the colour words, etc. etc. were there one after the other, like rules for each of the chess pieces, how would I know that those were *all* the chapters? If there turns out to be a common property in all the chapters so far in existence, we seem to have encountered a logical generality that is not an essential, i.e. *a priori* generality. But we can't say that the fact that chess is played with 16 pieces is any less essential to it than its being played on a chessboard.

Page 216

Since time and the truth-functions taste so different, and since they manifest their nature only and wholly in grammar, it is grammar that must explain the different taste.

Page 216

One tastes like content, the other like form of representation.

Page 216

They taste as different as a plan and a line through a plan.

Page Break 217

Page 217

It appears to me that the present, as it occurs in the proposition "the sky is blue" (if this proposition isn't meant as a hypothesis), is not a form of time, so that the present in *this* sense is atemporal.

Page 217

Does time enter into a landscape picture? or into a still life?

Page 217

Literature consisting of descriptions of landscapes.

Page 217

It is noteworthy that the time of which I am here speaking is not time in a physical sense. We are not concerned with measuring time. It is fishy that something which is unconnected with measurement is supposed to have a role in propositions like that of physical time in the hypotheses of physics.

Page 217

Discuss:

Page 217

The distinction between the logic of the content and the logic of the propositional form in general. The former seems, so to speak, brightly coloured, and the latter plain; the former seems to be concerned with what the picture represents, the latter to be a characteristic of the pictorial form like a frame.

Page 217

By comparison with the way in which the truth-functions are applicable to all propositions, it seems to us accidental that all propositions contain time in some way or other.

Page 217

The former seems to be connected with their nature as propositions, the latter with the nature of the reality we encounter.

((Added later in the margins))

A sentence can contain time in very different senses.

You are hurting me.

The weather is marvellous outside.

The Inn flows into the Danube.

Water freezes at 0°.

I often make slips of the pen

Some time ago...

I hope he will come.

At 5 o'clock.

Page Break 218

This kind of steel is excellent.
The earth was once a ball of gas.

Page Break 219

6:
The Nature of Hypotheses

Page 219

You could obviously explain an hypothesis by means of pictures. I mean, you could e.g. explain the hypothesis "there is a book lying here" with pictures showing the book in plan, elevation and various cross-sections.

Page 219

Such a representation gives a *law*. Just as the equation of a curve gives a law, by means of which you may discover the ordinates, if you cut at different abscissae.

Page 219

In which case the verifications of particular cases correspond to cuts that have actually been made.

Page 219

If our experiences yield points lying on a straight line, the proposition that these experiences are various views of a straight line is an hypothesis.

Page 219

The hypothesis is a way of representing this reality, for a new experience may tally with it or not, or possibly make it necessary to modify the hypothesis.

Page 219

If for instance we use a system of coordinates and the equation for a sphere to express the proposition that a sphere is located at a certain distance from our eyes, this description has a greater multiplicity than that of a verification by eye. The first multiplicity corresponds not to *one* verification but to a law obeyed by verifications.

Page 219

An hypothesis is a law for forming propositions.

Page 219

You could also say: an hypothesis is a law for forming expectations.

Page 219

A proposition is, so to speak, a particular cross-section of an hypothesis.

Page 219

According to my principle two suppositions must have the same sense if every *possible* experience that confirms the one also

Page Break 220

confirms the other, if, that is, no decision between the two is conceivable on the basis of experience.

Page 220

The representation of a curve as a straight line with deviations. The equation of the curve includes a parameter whose course expresses the deviations from a straight line. It isn't essential that these deviations should be "slight". They can be so large that the curve doesn't look like a straight line at all. "Straight line with deviations" is only one form of description. It makes it easier for me to eliminate, or neglect, a particular component of the description if I so wish. (The form "rule with exceptions").

Page 220

What does it mean, to be certain that one has toothache? (If one *can't* be certain, then grammar doesn't allow the use of the word "certain" in this connection.)

Page 220

The grammar of the expression "to be certain".

Page 220

We say "If I say that I see a chair there, I am saying more than I know for certain". And commonly that means "But all the same, there's *one* thing that I do know for certain." But if we now try to say what it is, we find ourselves in a certain embarrassment.

Page 220

"I see something *brown*--that is certain." That's meant to say that the brown colour is seen and not perhaps merely conjectured from other symptoms. And we do indeed say quite simply: "I *see* something brown."

If someone tells me "Look into this telescope, and make me a sketch of what you see", the sketch I make is the expression of a proposition, not of a hypothesis.

If I say "Here there is a chair", I mean more--people say--than the mere description of what I perceive. This can only mean that that proposition doesn't have to be true, even though the description fits what is seen. Well, in what circumstances would I say that that proposition wasn't true? Apparently, if certain other

propositions aren't true that were implicit in the first. But it isn't as if the first turns out to have been a logical product all along.

The best comparison for every hypothesis,--something that is itself an example of an hypothesis--is a body in relation to a systematic series of views of it from different angles.

Making a discovery in a scientific investigation (say in experimental physics) is of course not the same thing as making a discovery in ordinary life outside the laboratory; but the two are *similar* and a comparison with the former can throw light on the latter.

There is an essential distinction between propositions like "That is a lion", "The sun is larger than the earth", and propositions like "Men have two hands". Propositions like the first pair contain a "this", "now", "here" and thus connect immediately with reality. But if there happened to be no men around, how would I go about checking the third proposition?

It is always single faces of hypotheses that are verified.

Perhaps this is how it is: what an hypothesis explains is itself only expressible by an hypothesis. Of course, this amounts to asking whether there are any primary propositions that are definitively verifiable and not merely facets of an hypothesis. (That is rather like asking: are there surfaces that aren't surfaces of bodies?)

At all events, there can't be any distinction between an hypothesis used as an expression of an immediate experience and a proposition in the stricter sense.

There is a distinction between a proposition like "Here there is a sphere in front of me" and "It looks as if there is a sphere in front of me". The same thing shows itself also thus: one can say "There seems to be a sphere in front of me", but it is senseless to say "It looks as if there seems to be a sphere here". So too one can say

"Here there is probably a sphere", but not "Here there probably appears to be a sphere". In such a case people would say "After all, you must know whether there *appears* to be".

There is nothing hypothetical in what connects the proposition with the given fact.

It's clear that reality--I mean immediate experience--will sometimes give an hypothesis the answer yes, and sometimes the answer no (here of course the "yes" and "no" express only confirmation and lack of confirmation); and it's clear that these affirmations and denials can be given expression.

The hypothesis, if *that* face of it is laid against reality, becomes a proposition.

It may be doubtful whether the body I see is a sphere, but it can't be doubtful that from here it looks to be something like a sphere.--The mechanism of hypothesis would not function if appearance too were doubtful so that one couldn't verify beyond doubt even a facet of the hypothesis. If there were a doubt here, what could take the doubt away? If this connection too were loose, there would be no such thing as confirming an hypothesis and it would hang entirely in the air, quite pointless (and therefore senseless).

If I say "I saw a chair", that (in *one* sense) isn't contradicted by the proposition "there wasn't one there". For I could use the first proposition in the description of a dream and then nobody would use the second to contradict me.

But the description of the dream throws a light on the sense of the words "*I saw*".

Page 222

Again, in the proposition "there wasn't one there", the word "there" may have more than one meaning.

Page Break 223

Page 223

I am in agreement with the opinions of contemporary physicists when they say that the signs in their equations no longer have any "meanings" and that physics cannot attain to any such meanings, but must stay put at the signs. But they don't see that the signs have meaning in as much as--and only in as much as--observable phenomena do or do not correspond to them, in however circuitous a manner.

Page 223

Let us imagine that chess had been invented not as a board game, but as a game to be played with numbers and letters on paper, so that no one had ever imagined a board with 64 squares in connection with it. And now suppose someone made the discovery that the game corresponded exactly to a game which could be played on a board in such and such a way. This discovery would have been a great simplification of the game (people who would earlier have found it too difficult could now play it). But it is clear that this new illustration of the rules of the game would be nothing more than a new, more easily surveyable symbolism, which in other respects would be on the same level as the written game. Compare with this the talk about physics nowadays not working with mechanical models but "only with symbols".

Page Break 224

7: *Probability*

Page 224

The probability of an hypothesis has its measure in how much evidence is needed to make it profitable to throw it out.

Page 224

It's only in this sense that we can say that repeated uniform experience in the past renders the continuation of this uniformity in the future probable.

Page 224

If, in this sense, I now say: I assume the sun will rise again tomorrow, because the opposite is so unlikely, I here mean by "likely" and "unlikely" something completely different from what I mean by these words in the proposition "It's equally likely that I'll throw heads or tails". The two meanings of the word "likely" are, to be sure, connected in certain ways, but they aren't identical.

Page 224

We only give up an hypothesis for an ever higher gain.

Page 224

Induction is a process based on a principle of economy.

Page 224

The question how simple a representation is yielded by assuming a particular hypothesis is directly connected, I believe, with the question of probability.

Page 224

We may compare a part of an hypothesis with the movement of a part of a gear, a movement that can be stipulated without prejudicing the intended motion. But then of course you have to make appropriate adjustments to the rest of the gear if it is to produce the desired motion. I'm thinking of a differential gear.--Once I've decided that there is to be no deviation from a certain part of my hypothesis no matter what the experience to be described may be, I have stipulated a mode of representation and this part of my hypothesis is now a postulate.

Page Break 225

Page 225

A postulate must be such that no conceivable experience can refute it, even though it may be extremely inconvenient to cling to the postulate. To the extent to which we can talk here of greater or slighter convenience, there is a greater or slighter probability of the postulate.

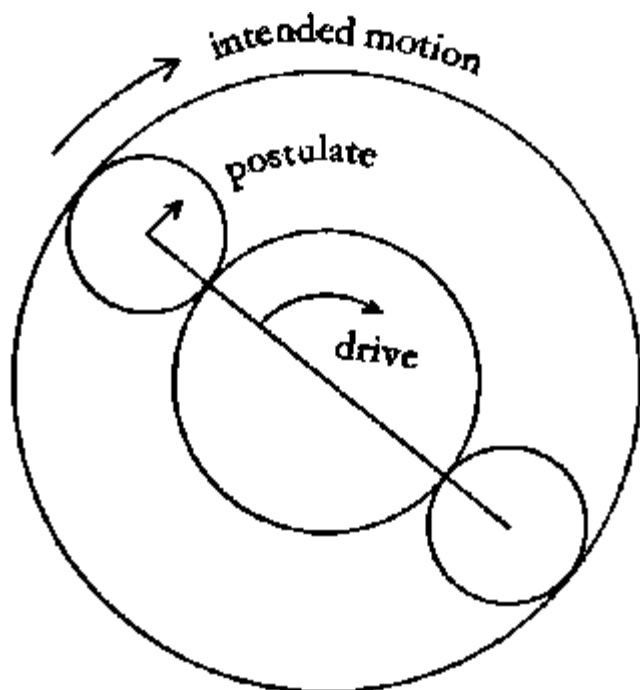

Page 225

It's senseless to talk of a measure for this probability at this juncture. The situation here is like that in the case of two kinds of numbers where we can with a certain justice say that the one is more like the other (is closer to it) than a third, but there isn't any numerical measure of the similarity. Of course you could imagine a measure being constructed in such cases, too, say by counting the postulates or axioms common to the two systems, etc. etc.

Page 225

I give someone the following piece of information, and no more: at such and such a time you will see a point of light appear in the interval AB.

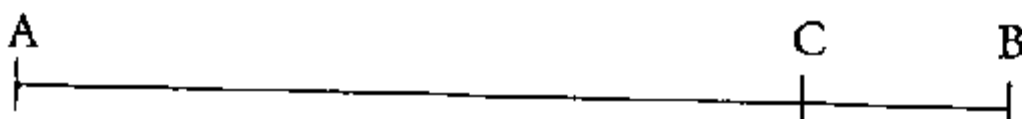

Does the question now makes sense "Is it more likely that this point will appear in the interval AC than in CB"? I believe, obviously not.--I can of course decide that the probability of the event's happening in CB is to be in the ratio CB/AC to the

Page Break 226

probability of its happening in AC; however, that's a decision I can have empirical grounds for making, but about which there is nothing to be said *a priori*. It is possible for the observed distribution of events not to lead to this assumption. The probability, where infinitely many possibilities come into consideration, must of course be treated as a limit. That is, if I divide the stretch AB into arbitrarily many parts of arbitrary lengths and regard it as equally likely that the event should occur in any one of these parts, we immediately have the simple case of dice before us. And now I can--arbitrarily--lay down a law for constructing parts of equal likelihood. For instance, the law that, if the lengths of the parts are equal, they are equally likely. But any other law is just as permissible.

Page 226

Couldn't I, in the case of dice too, take, say, five faces together as one possibility, and oppose them to the sixth as the second possibility? And what, apart from experience, is there to prevent me from regarding these two possibilities as equally likely?

Page 226

Let's imagine throwing, say, a red ball with just one very small green patch on it. Isn't it much more likely in this case for the red area to strike the ground than for the green?--But how would we support this proposition? Presumably by showing that when we throw the ball, the red strikes the ground much more often than the green. But that's got nothing to do with logic.--We may always project the red and green surfaces and what befalls them onto a surface in such a way that the projection of the green surface is greater than or equal to the red; so that the events, as seen in this projection, appear to have a quite different probability ratio from the one they had on the original surface. If, e.g. I reflect the events

in a suitably curved mirror and now imagine what I would have held to be the more probable event if I had only seen the image in the mirror.

The one thing the mirror can't alter is the number of clearly demarcated possibilities. So that if I have n coloured patches on my ball, the mirror will also show n , and if I have *decided* that these are to be regarded as equally likely, then I can stick to this decision for the mirror image too.

To make myself even clearer: if I carry out the experiment with a concave mirror, i.e. make the *observations* in a concave mirror, it will perhaps then look as if the ball falls more often on the small surface than on the much larger one; and it's clear that neither experiment--in the mirror or outside it--has a claim to precedence.

We may apply our old principle to propositions expressing a probability and say, we shall discover their sense by considering what verifies them.

If I say "That will probably occur", is this proposition verified by the occurrence or falsified by its non-occurrence? In my opinion, obviously not. In that case it doesn't say anything about either. For if a dispute were to arise as to whether it is probable or not, it would always be arguments from the past that would be adduced. And this would be so even when what actually happened was already known.

Causality depends on an observed uniformity. This does not mean that a uniformity so far observed will always continue, but what cannot be altered is that the events so far have been uniform; *that* can't be the uncertain result of an empirical series which in its turn isn't something given but something dependent on another uncertain one and so on *ad infinitum*.

When people say that the proposition "it is probable that p will occur" says something about the event p , they forget that the probability remains even when the event p does *not* occur.

The proposition " p will probably occur" does indeed say something about the future, but not something "about the event p ", as the grammatical form of the statement makes us believe.

If I ask for the grounds of an assertion, the answer to the question holds not only for this person and for *this* action (assertion), but quite *generally*.

If I say "the weather looks like rain" do I say anything about future weather? No; I say something about the present weather, by means of a law connecting weather at any given time with weather at an earlier time. This law must already be in existence, and we are using it to construct certain statements about our experience.--

We might say the same of historical statements too. But I was too quick to say that the proposition "the weather looks like rain" says nothing about future weather. It all depends what is meant by "saying something about something". The sentence says just what it says.

The sentence " p will probably occur" says something about the future only in a sense in which its truth and falsehood are completely independent of what will happen in the future.

If we say: "the gun is now aiming at the point p " we aren't saying anything about where the shot will hit. Giving the point at which it is aiming is a *geometrical* means of assigning its direction. That this is the means we use is certainly connected with certain observations (projectile parabolas, etc.) but these observations don't enter into our present description of the direction.

Parabola



Page Break 229

Page 229

A Galtonian photograph is the picture of a probability.

Page 229

The law of probability is the natural law you see when you screw up your eyes.

Page 229

"On average, the points yielded by the experiment lie on a straight line". "If I throw with a good die, then on average I throw a one every six throws". What does that mean? Is the proposition compatible with *any* experience I may have? If so, it says nothing. Have I decided in advance which experiences are incompatible with it and what is the limit beyond which exceptions may not go without upsetting the rule? No. But couldn't I have set such a limit? Of course.--Suppose that the limit had been set thus: if 4 out of 6 successive throws turn out the same, then it's a bad die. Now someone says: "But if that happens only very seldom, mayn't it be a good one after all?"--To that the answer is as follows. If I permit the turning up of 4 similar throws among 6 successive ones to occur within a certain number of throws, then I am replacing the first limit with a *different* one. But if I say "any number of similar successive throws is allowed, as long as it happens sufficiently rarely", then strictly speaking I've defined the goodness of the die in a way that makes it independent of the result of the throws; unless by the goodness of a die I do not mean a property of the die, but a property of a particular game played with it. In that case I can certainly say: in any game I call the die good provided that among the N throws of the game there occur not more than $\log N$ similar successive throws. However, that doesn't give a test for the checking of dice, but a criterion for judging a particular game.

Page 229

We say that if the die is quite regular and isn't interfered with then the distribution of the numbers 1, 2, 3, 4, 5, 6 among the throws must be uniform, since *there is no reason* why one number should occur more often than another.

Page Break 230

Page 230

But now let's represent the throws by the values of the function $(x - 3)^2$ for the arguments 1 to 6, i.e. by the numbers 0, 1, 4, 9 instead of by the numbers 1 to 6. Is there a reason why one of *these* numbers should turn up in the new results more often than another? This shows us that the *a priori* law of probability, like the minimum-principles of mechanics etc., is a form that laws may take. If it had been discovered by experiment that the distribution of the throws 1 to 6 with a regular die was such that the distribution of the values of $(x - 3)^2$ was uniform, it would have been *this* regularity that was defined as the *a priori* regularity.

Page 230

We do the same thing in the kinetic theory of gases: we represent the distribution of molecular movements in the form of some sort of uniform distribution; but we make the choice of *what* is uniformly distributed--and in the other case of *what* is reduced to a minimum--in such a way that our theory agrees with experience.

Page 230

"The molecules move purely according to the laws of probability" is supposed to mean: physics gets out of the way, and now the molecules move as it were purely according to laws of logic. This idea is similar to the idea that the law of inertia is an *a priori* proposition: there too one speaks of what a body does when it isn't interfered with. But what is the criterion for its not being interfered with? Is it ultimately that it moves uniformly in a straight line? Or is it something different? If the latter, then it's a matter of experience whether the law of inertia holds; if the former, then it wasn't a law at all but a definition. So too with the proposition, "if the particles aren't interfered with, then the distribution of their motions is such and such". What is the criterion for their not being interfered with? etc.

Page 230

To say that the points yielded in this experiment lie roughly on this line, e.g. a straight line, means something

like: "seen for this distance, they seem to lie on a straight line".

Page Break 231

Page 231

I may say that a stretch gives the general impression of a straight line; but I cannot say: "This bit of line looks straight, for it could be a bit of a line that as a whole gives me the impression of being straight." (Mountains on the earth and moon. The earth a ball.)

Page 231

An experiment with dice lasts a certain time, and our expectations about future throws can only be based on tendencies we observe in what happens during this experiment. That is to say, the experiment can only give grounds for expecting that things will go in *in the way* shown by the experiment; but we can't expect that the experiment, if continued, will now yield results that tally better with a preconceived idea of its course than did those of the experiment we have actually performed. So if, for instance, I toss a coin and find no tendency in the results of the experiment itself for the number of heads and tails to approximate to each other more closely, then the experiment gives me no reason to suppose that if it were continued such an approximation would emerge. Indeed, the expectation of such an approximation must *itself* refer to a definite point in time, since we can't say we're expecting something to happen *eventually*, in the infinite future.

Page 231

Any "reasonable expectation" is an expectation that a rule we have observed up to now will continue to hold.

Page 231

(But the rule must have been observed and can't, for its part too, be merely expected.)

Page 231

The logic of probability is only concerned with the state of expectation in the sense in which logic in general is concerned with thinking.

Page 231

A ray is emitted from the light source S striking the surface AB to form a point of light there, and then striking the surface AB'. We have no reason to suppose that the point on AB lies to the left or to the right of M, and equally none for supposing that the

Page Break 232

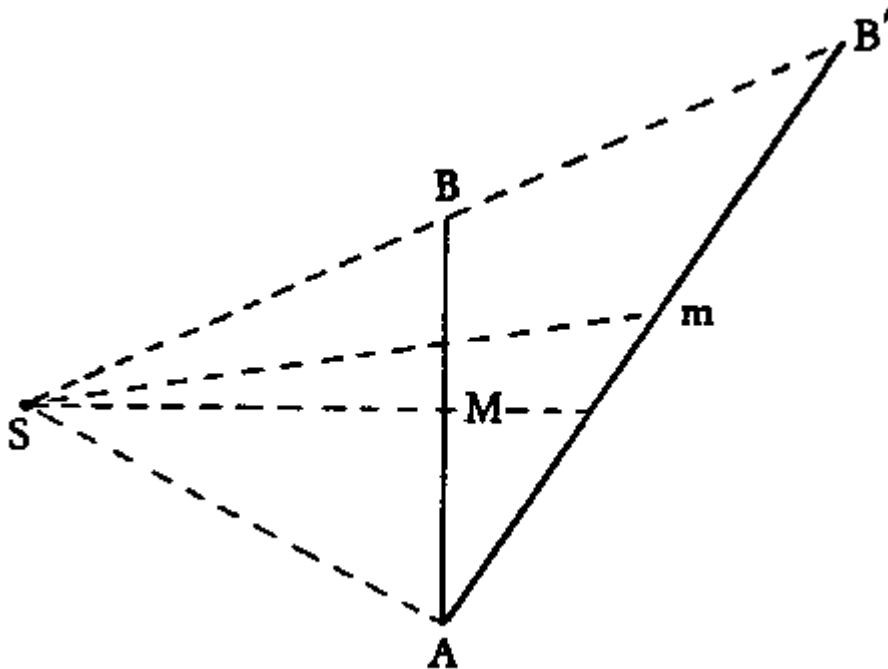

point on AB' lies on one side or the other of m. This yields therefore incompatible probabilities. But if I make an assumption about the probability of the point on AB lying in AM, how is this assumption verified? Surely, we think, by a frequency experiment. Supposing this confirms the view that the probabilities of AM and BM are equal (and so the probabilities of Am and B'm differ), then it is recognized as the right one and thus shows itself to be an hypothesis belonging to physics. The geometrical construction merely shows that the fact that $AM = MB$ was *no* ground for assuming equal likelihood.

Page 232

Suppose that measurement shows the die to be accurate and regular, that the numbers on its sides don't influence the throws, and that it is thrown by a hand whose movements follow no definite rules: does it follow that

the distribution among the throws of each of the throws from 1 to 6 will be uniform on average? Where is the uniform distribution supposed to come from? The accuracy and regularity of the die can't establish that the distribution of throws will be *uniform on average*. (It would be, as it were, a monochrome premise with a mottle conclusion.) And we

Page Break 233

haven't made any suppositions about the movements while throwing. (Making the bundles of hay equal gives reason to believe that the donkey will starve to death between them; it doesn't give reason to believe that he will eat from each with roughly equal frequency.)--It is perfectly compatible with our assumptions for one hundred ones to be thrown in succession, if friction, hand-movements and air-resistance coincide appropriately. The experimental fact that this never happens is a fact about those factors, and the hypothesis that the throws will be uniformly distributed is an hypothesis about the operation of those factors.

Page 233

Suppose someone says that a lever with arms of equal length must remain at rest under the influence of equal and opposite forces, since there is no cause to make it move to one side rather than to the other. That only means that if the lever moves to one side after we have ascertained the equality of the arms and the equal and opposite nature of the forces, then we can't explain this on the basis of the preconditions we know or have assumed. (The form that we call "explanation" must be asymmetrical: like the operation which makes " $2a + 3b$ " out of " $a + b$ "). But on the basis of our presuppositions we can indeed explain the lever's continuance at rest.--Could we also explain a swing to left and right with roughly equal frequency? No, because once again the swing involves asymmetry; we would only explain the symmetry in this asymmetry. If the lever had rotated to the right with a uniform motion, one could similarly have said: given the symmetry of the conditions I can explain the uniformity of the motion, but not its direction.

Page 233

A lack of uniformity in the distribution of the throws is *not* to be explained by the symmetry of the die. It is only to this extent that the symmetry explains the uniformity of the distribution.--For one can of course say: if the numbers on the sides of the die have no effect, then the difference between them cannot explain an irregularity in the distribution; and of course similar circumstances can't explain differences; and so to that extent one might infer a regularity. But in that case why is there any difference at

Page Break 234

all between different throws? Whatever explains that must also explain their approximate regularity. It's just that the regularity of the die doesn't interfere with that regularity.

Page 234

Suppose that a man throwing dice every day threw nothing but ones for a week, using dice that proved good by every other method of testing and that gave the usual results when thrown by others. Has he grounds, now, for supposing that there is a law of nature that he will always throw ones? Has he grounds for believing that it will go on like this, or has he grounds for believing that this regularity can't last much longer? Has he reason to abandon the game since it has become clear that he can only throw ones, or reason to play on since in these circumstances it is all the more probable that he will throw a higher number at the next throw? In actual fact, he will refuse to accept the regularity as a natural law: at least, it will have to go on for a long time before he will entertain the possibility. But why? I believe it is because so much of his previous experience in life speaks against there being a law of nature of such a sort, and we have--so to speak--to surmount all that experience, before embracing a totally new way of looking at things.

Page 234

If we infer from the relative frequency of an event its relative frequency in the future, we can of course only do that from the frequency which has in fact been so far observed. And not from one we have derived from observation by some process or other for calculating probabilities. For the probability we calculate is compatible with *any* frequency *whatever* that we actually observe, since it leaves the time open.

Page 234

When a gambler or insurance company is guided by probability, they aren't guided by the probability calculus, since one can't be guided by this on its own, because *anything* that happens can be reconciled with it: no, the insurance company is guided by a

Page Break 235

frequency actually observed. And that, of course, is an absolute frequency.

The concept "about"
Problem of the "heap"

Page 236

"He came from about there →."

Page 236

"About *there* is the brightest point of the horizon".

Page 236

"Make the plank about 2 m long".

Page 236

In order to say this, must I know of limits which determine the margin of tolerance of this length? Obviously not. Isn't it enough e.g. to say "A margin of ± 1 cm is perfectly permissible; 2 would be too much"?--Indeed it's an essential part of the sense of my proposition that I'm not in a position to give "precise" bounds to the margin. Isn't that obviously because the space in which I am working here doesn't have the same metric as the Euclidean one?

Page 236

Suppose one wanted to fix the margin of tolerance exactly by experiment, by altering the length, approaching the limits of the margin and asking in each case whether such a length would do or not. After a few shortenings one would get contradictory results: at one time a point would be described as being within the limits, and at another time a point closer in would be described as impermissible, each time perhaps with the remark that the answers were no longer quite certain.

Page 236

It is the same sort of uncertainty as occurs in giving the highest point of a curve. We just aren't in Euclidean space and here there isn't a highest point in the Euclidean sense. The answer will mean "The highest point is about *there*" and the grammar of the word "about"--in this context--is part of the geometry of our space.

Page 236

Surely it is like the way the butcher weighs things only to the nearest ounce, though that is arbitrary and depends on what are the customary counterweights. Here it is enough to know: it doesn't weigh more than P_1 and it doesn't weigh less than P_2 . One might say: in principle giving the weight thus isn't giving a

Page Break 237

number, but an interval, and the intervals make up a discontinuous series.

Page 237

Yet one might say: "at all events keep *within* ± 1 cm", thus setting an arbitrary limit.--If someone now said "Right, but that isn't the real limit of the permissible tolerance; so what is?" the answer would be e.g. "I don't know of any; I only know that ± 2 is too much".

Page 237

Imagine the following psychological experiment.

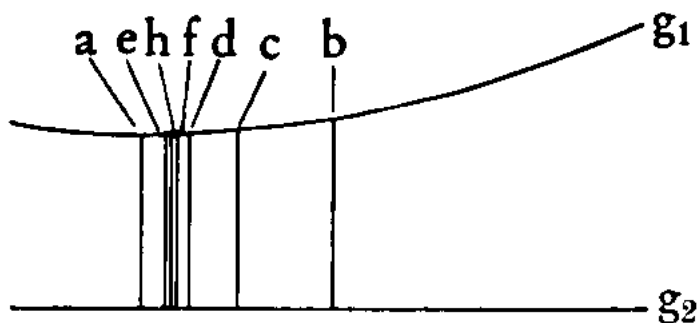

The subject is shown curves g_1 g_2 with a straight line A drawn across them. I will call the section of this line between g_1 and g_2 a. Parallel to a we now draw b at an arbitrary distance and ask the subject whether he sees the section b as bigger than a, or cannot any longer distinguish between the two lengths. He replies that b seems bigger than a. Next we move closer to a, measuring half the distance from a to b and drawing c. "Do you see c as bigger than a?" "Yes."--We halve the distance c-a and draw d. "Do you see d as bigger than a?" "Yes." We halve a-d. "Do you see e as bigger than a?"--"No."--So we halve e-d. "Do you see f as bigger than e?"--"Yes."--So we halve e-f and draw h. We might approach the line a from the left hand side as well and then say that what corresponds in Euclidean space to a seen length a is not a single length but an interval of lengths, and in a similar way what corresponds to a single

seen position of a line (say the pointer of an instrument) is an interval of positions in Euclidean space; but this interval has no precise limits. That means: it is bounded not by

Page Break 238

points, but by converging intervals which do not converge upon a point. (Like the series of binary fractions that we get by throwing heads and tails.) The special thing about two intervals which are bounded in this *blurred* way instead of by points is that in certain cases the answer to the question whether they overlap or are quite distinct is "undecided"; and the question whether they touch, whether they have an end-point in common, is always a senseless one since they don't have end-points at all. But one might say "they have *de facto* end-points", in the sense in which the development of π has a *de facto* end. There is of course nothing mysterious about this property of "blurred" intervals; the somewhat paradoxical character is explained by the double use of the word "interval".

Page 238

The case is the same as that of the double use of the word "chess" to mean at one time the totality of the currently valid chess rules, and at another time the game invented in Persia by N. N. which developed in such and such a way. In one case it is nonsensical to talk of a development of the rules of chess and in another not. What we mean by "the length of a measured section" may be either what results from a particular measurement which I carry out today at 5 o'clock--in that case there is no " \pm etc." for this assignment of length--or, something to which measurements approximate, etc.; in the two cases the word "length" is used with quite different grammars. So too the word "interval" if what I mean by an interval is at one time something fixed and at another time something in flux.

Page 238

But we must not be surprised that an interval should have such a strange property; for we're now just using the word "interval" in a sense different from the usual one. And we can't say that we have discovered new properties of certain intervals, any more than we would discover new properties of the king in chess if we altered the rules of the game while keeping the designation "chess" and "king". (On the other hand cf. Brouwer on the law of excluded middle.)

Page Break 239

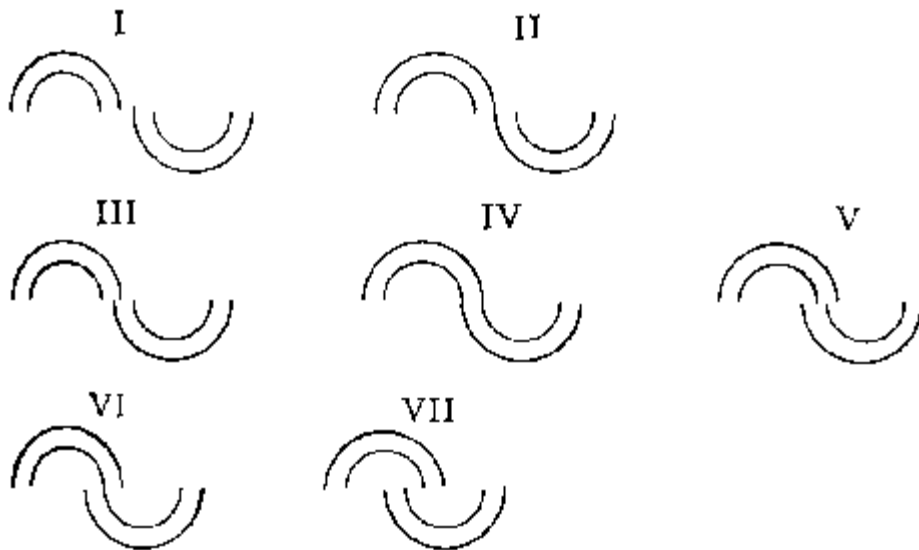

Page 239

- I) the intervals are separate
- II) they are separate with a *de facto* contact
- III) undecided
- IV) undecided
- V) undecided
- VI) they overlap
- VII) they overlap

Page 239

So basically that experiment gives what we have called a "blurred" interval; on the other hand of course we could conceive experiments which would give a sharp interval instead. Suppose we moved a straight-edge from the starting position b, in the direction of a, keeping it parallel to b, until our subject began to display a particular reaction; in that case we could call the point at which the reaction first occurs the limit of our strip. Likewise we

might of course call the result of a weighing "the weight of a body" and in that sense there would be an absolutely exact weighing, that is, one whose result did not have the form " $W \pm w$ ". We would thus have altered the form of our expression, and we would have to say that the weight of bodies varied according to a law that was unknown to us. (The distinction between "absolutely exact" weighing and "essentially inexact weighing" is a grammatical distinction connected with two different meanings of the expression "result of weighing").

Page Break 240

Page 240

The indeterminacy of the word "heap". I could give as a definition: a body of a certain form and consistency etc. is a heap, if it has a volume of K cubic metres, or more; anything less than that I will call a heaplet. In that case there is no largest heaplet; that means, it is senseless to speak of a largest heaplet. Conversely, I could decide: whatever is bigger than K cubic metres is to be a heap, and in that case the expression "the smallest heap" has no meaning. But isn't this distinction an idle one? Certainly--if by the volume we mean a result of measurement in the normal sense; for such a result has the form " $V \pm v$ ". But otherwise the distinction would be no more idle than the distinction between threescore apples and 61 apples.

Page 240

About the problem of the "heap": Here, as in similar cases, one might think that there is an official concept like the official length of a pace; say "A heap is anything that is bigger than half a cubic metre". But this would still not be the concept we normally use. For that there exists no delimitation (and if we fix one, we are altering the concept); it is just that there are cases that we count as within the extension of the concept, and cases that we no longer count as within the extension of the concept.

Page 240

"Make me a heap of sand here."--"Fine, that is certainly something he would call a heap." I was able to obey the command, so it was in order. But what about this command "Make me the smallest heap you would still call a heap"? I would say: that is nonsense; I can only determine a *de facto* upper and lower limit.

Page Break 241

Part II: On Logic and Mathematics

Page Break 242

Page Break 243

I LOGICAL INFERENCE

*Is it because we understand the propositions that we know that q entails p ?
Does a sense give rise to the entailment?*

Page 243

$p.q. = .p$ means " q follows from p ".

P	q	$p \vee q$	q	$(p \vee q).q$	$(p \vee q) \vee q$
T	T	T	T	T	T
T	F	T	F	F	T
F	T	T	T	T	T
F	F	F	F	F	F

Page 243

$(\exists x).fx \vee fa. = .(\exists x).fx, (\exists x).fx.fa. = .fa$. How do I know that? (Because for the equation above I gave a kind of proof). One might say something like: "I just understand ' $(\exists x).fx$ '". (An excellent example of what "understand" means).

But I might equally ask "How do I know that $(\exists x).fx$ follows from fa ?" and answer "because I understand ' $(\exists x).fx$ '."

But really how do I know that it follows?--Because that is the way I calculate.

How do I know that $(\exists x).fx$ follows from fa ? Is it that I as it were see behind the sign " $(\exists x).fx$ ", that I see the sense lying behind it and see from that that it follows from fa ? Is *that* what understanding is?

No, what that equation expresses is a part of the understanding (that is thus unpacked before my eyes).

Compare the idea that understanding is first of all grasping in a flash something which then has to be unpacked like that.

If I say "I know that $(\exists x).fx$ follows, because I understand it" that would mean, that when I understand it, I see something *different* from the sign I'm given, a kind of definition of the sign which gives rise to the entailment.

Isn't it rather that the connection is set up and prescribed by the equations? For there is no such thing as a hidden connection.

$(\exists x).fx$	fa
T	T
T	F
F	T
F	F

But, I used to think, mustn't $(\exists x).fx$ be a truth function of fa for that to be possible, for that connection to be possible?

For doesn't $(\exists x).Fx \vee Fa = (\exists x).fx$ simply say that fa is already contained in $(\exists x).fx$? Doesn't it show the connection between the fa and the $(\exists x).fx$? Not unless $(\exists x).fx$ is *defined* as a logical sum (with fa as one of the terms of the sum).--If that is the case, then $(\exists x).fx$ is merely an abbreviation.

In logic there is no such thing as a hidden connection.

You can't get behind the rules, because there isn't any behind.

$fE.f_a = fa$. Can one say: that is only possible if fE follows from fa ? Or must one say: that settles that fE is to follow from fa ?

If the former, it must be the structure that makes it follow, say because fE is so defined as to have the appropriate structure. But can the entailment really be a kind of result of the visible structure of the signs, in the way that a physical reaction is the result of a physical property? Doesn't it rather always depend on stipulations like the equation $fE.f_a = .fa$? Can it be read off from $p \vee q$ that

it follows from p , or only from the rules Russell gives for the truth-functions?

And why should the rule $fE.fa. = .fa$ be an effect of another rule rather than being itself the primary rule?

Page 245

For what is "fE must somehow contain fa" supposed to mean? It doesn't contain it, in so far as we can work with fE without mentioning fa; but it does in so far as the rule $fE.fa. = .fa$ holds.

Page 245

But the idea is that $fE.fa. = fa$ can only hold in virtue of a definition of fE.

Page 245

That is, I think, because otherwise it looks, wrongly, as if a further stipulation had been made about fE after it had already been introduced into the language. But in fact there isn't any stipulation left for future experience to make.

Page 245

And the definition of fE in terms of "all particular cases" is *no less* impossible than the enumeration of *all* rules of the form $fE.fx. = fx$.

Page 245

Indeed the individual equations $fE.fx. = fx$ are just precisely an expression of this impossibility.

Page 245

If we are asked: but is it now really certain that it isn't a different calculus being used, we can only say: if that means "don't we use other calculi too in our real language?" I can only answer "I don't know any others at present". (Similarly, if someone asked "are these all the calculi of contemporary mathematics?" I might say "I don't remember any others, but I can read it up and find out more exactly"). But the question cannot mean "can no other calculus be used?" For how is the answer to that question to be discovered?

Page 245

A calculus exists when one describes it.

Page Break 246

Page 246

Can one say 'calculus' is not a mathematical concept?

Page 246

If I were to say "whether p follows from q must result from p and q alone": it would have to mean this: that p follows from q is a stipulation that determines the sense of p and q, not some extra truth that can be asserted about the sense of both of them. Hence one can indeed give rules of inference, but in doing so one is giving for the use of the written signs rules which determine their as yet undetermined sense; and that means simply that the rules must be laid down arbitrarily, i.e. are not to be read off from reality like a description. For when I say that the rules are arbitrary, I mean that they are not determined by reality in the way the description of reality is. And that means: it is nonsense to say that they agree with reality, e.g. that the rules for the words "blue" and "red" agree with the facts about those colours etc.†1

Page 246

What the equation $p.q = p$ really shows is the connection between entailment and the truth-functions.

Page Break 247

2

"If p follows from q, then thinking that q must involve thinking that p."

Page 247

Remember that a general proposition might entail a logical sum of a hundred or so terms, which we certainly didn't think of when we uttered the general proposition. Yet can't we say that it follows from it?

Page 247

"What follows from a thought must be involved in thinking it. For there is nothing in a thought that we aren't aware of while we are thinking it. It isn't a machine which might be explored with unexpected results, a machine which might achieve something that couldn't be read off from it. That is, the way it works is *logical*, it's quite different from the way a machine works. *Qua* thought, it contains nothing more than was put into it. As a machine functioning causally, it might be believed capable of anything; but in logic we get out of it only what we meant by it."

Page 247

If I say that the square is entirely white, I don't think of ten smaller rectangles contained in it which are white, and I can't think of "*all*" rectangles or patches contained in it. Similarly in the proposition "he is in the room" I don't think of a hundred possible positions he might be in and certainly not of *all* possible positions.

"Wherever you hit the target you've won. You've hit it in the upper right hand section, so... "

At first sight there seem to be two kinds of deduction: in one of them the premise mentions everything the conclusion does and in the other not. An instance of the first kind is the inference from p.q to q; an instance of the second is the inference; the whole stick is white, so the middle third of it is white too. This conclusion mentions boundaries that are not mentioned in the first proposition. (That is dubious.) Again, if I say "If you hit the target anywhere in this circle you will win the prize..." and then "You have hit it here, so..." the place mentioned in the second proposition was not prescribed in the first. The target after the shot stands in a certain internal relation to the target as I saw it before, and that

relation consists in the shot's falling within the bounds of the general possibility that we foresaw. But the shot was not in itself foreseen and did not occur, or at least need not have occurred, in the first picture. For even supposing that at the time I thought of a thousand definite possibilities, it was at least possible for the one that was later realised to have been omitted. And if the foreseeing of that possibility really had been essential, the overlooking of this single case would have given the premise the wrong sense and the conclusion wouldn't any longer follow from it.

On the other hand you don't add anything to the proposition "Wherever you hit this circle..." by saying "Wherever you hit this circle, and in particular if you hit the black dot..." If the black dot was already there when the first proposition was uttered, then of course it was meant too; and if it wasn't there, then the actual sense of the proposition has been altered by it.

But what is it supposed to mean to say "If one proposition follows from another, thinking the second must involve thinking the first", since in the proposition "I am 170 cm tall" it isn't necessary to think of even a single one of the negative statements of height that follow from it?

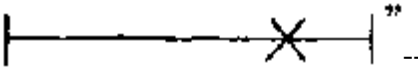
"The cross is situated thus on the straight line: 

"So it is between the strokes".

"It is 16½° here"--"So it is certainly more than 15°"

Incidentally, if you are surprised that one proposition can follow from another even though one doesn't think of the former while thinking of the latter, you should consider that $p \vee q$ follows from p, and I certainly don't think all propositions of the form $p \vee \xi$ while I am thinking p.

The whole idea that a proposition has to be thought along with any proposition that entails it rests on a false, psychologising notion. We must concern ourselves only with what is contained in the signs and the rules.

If the criterion for p's following from q consists in "thinking of p being involved in thinking of q" then while thinking of the proposition "in this box there are 10⁵ grains of sand", you are thinking also of the 10⁵ sentences "In this box there is one grain of sand" "... 2 grains of sand", etc. etc. What's the criterion here for the thought of one proposition's being involved in the thought of another?

And what about a proposition like "There is a patch (F) between the limits AA"?

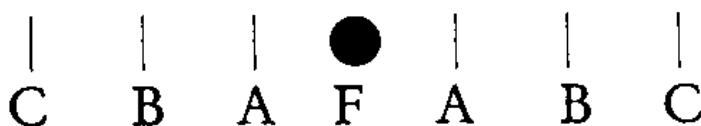

Doesn't it follow from that that F is also between BB and CC and so on? Don't infinitely many propositions follow from a single one? Does that make it infinitely significant?--From the proposition "There is a patch between the limits AA" there follow as many propositions of the type "there is a patch between the limits BB" as I write

out--and no more than I write out. Similarly, from p there follow as many propositions of the form $p \vee \xi$ as I write out (or utter etc.).

Page 249

(A proof by induction proves as many propositions of the form... as I write out.)

Page Break 250

3

The case of infinitely many propositions following from a single one

Page 250

Is it impossible that infinitely many propositions should follow from a single one--in the sense, that is, that we might go on ad infinitum constructing new propositions from a single one according to a rule?

Page 250

Suppose that we wrote the first thousand propositions of the series in conjunction. Wouldn't the sense of this product necessarily approximate more closely to the sense of our first proposition than the product of the first hundred propositions? Wouldn't we obtain an ever closer approximation to the first proposition the further we extended the product? And wouldn't that show that it can't be the case that from one proposition infinitely many others follow, since I can't understand even the product with 10^{10} terms and yet I understood the proposition to which the product with 10^{100} terms is a closer approximation than the one with 10^{10} terms?

Page 250

We imagine, perhaps, that the general proposition is an abbreviated expression of the product. But what is there in the product to abbreviate? It doesn't contain anything superfluous.

Page 250

If we need an example of infinitely many propositions following from a single one, perhaps the simplest is the way in which "a is red" entails the negation of all propositions that ascribe a different colour to a. The negative propositions are certainly not contained in the thought of the single positive one. Of course we might say that we don't distinguish infinitely many shades of colour; but the question is whether the number of shades of colour we distinguish has anything at all to do with the complexity of the first sentence: is it more or less complex the more or fewer colours we distinguish?

Page 250

Wouldn't this be what we'd have to say: it's only when a proposition exists that it follows from it. It's only when we have constructed ten propositions following from the first one that ten propositions do follow from it.

Page Break 251

Page 251

I want to say that one proposition doesn't follow from another until it is confronted with it. The "etc ad infinitum" indicates only the possibility [[sic]] of constructing propositions following from the first; it doesn't yield a definite number of such propositions.

Page 251

So mightn't I simply say: it is *because* it is impossible to write out infinitely many propositions (i.e. to say that is a piece of nonsense) that infinitely many propositions don't follow from a single proposition.

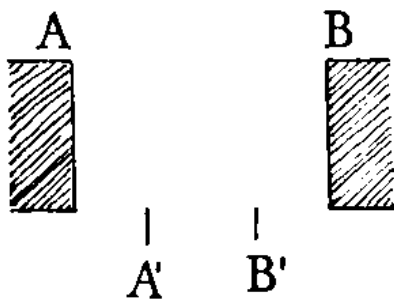

Page 251

What about the proposition "the surface is white from A to B"? It does follow from it that the surface is white from A' to B'. It needn't be a seen patch of white that is in question; and certainly the inference from the first proposition to the second is often drawn. Someone says to me "I have painted the patch white from A to B" and then I say "so it's certainly painted white from A' to B'".

Page 251



It must be possible to say a priori that $F(A'B')$ would follow from $F(AB)$.

If the lines A' and B' exist, then the second proposition certainly does follow from the first (in that case the compositeness is already there in the first proposition); but in that case it is only as many propositions as correspond to its compositeness that follow from the first proposition (and so never infinitely many).

"The whole is white, therefore a part bounded by such and such a line is white." "The whole *was* white, so that part of it also *was* white even if I didn't then perceive it bounded within it."

"A surface seen as undivided has no parts."

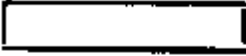
But let's imagine a ruler laid against the surface, so that the

appearance we are presented with is first  and then  and then



. It doesn't at all follow from the first strip's being entirely white that in the second and the third everything except the graduating lines is white.

"If you hit the target anywhere within the circle, you have won."

"I think you will hit the target somewhere within the circle."

Someone might ask about the first proposition: how do you know? Have you tried *all* possible places? And the answer would have to be: that isn't a proposition at all, it is a general *stipulation*.

The inference doesn't go like this: "If the shot hits the target anywhere, you have won. You have hit the target *there*, so you have won". For where is this *there*? Is it marked out in any way other than by the shot--say by a circle? And was that already there on the target beforehand? If not, then the target has changed; if so, it must have been foreseen as a possible place to hit. We should rather say: "You have hit the target, so..."

The place on the target does not necessarily have to be given by a mark on the target, like a circle. For there are always descriptions like "nearer the centre", "nearer the edge", "on the right side at the top", etc. Wherever the target is hit such descriptions *must* always be possible. (But there are not "infinitely many" such descriptions.)

Does it make sense to say: "But if you hit the target, you must hit it *somewhere*" or "Wherever he hits the surface it won't be a surprise, we won't have to say 'I didn't expect that. I didn't know there was such a place?'" What that means is that it can't be a geometrical surprise.

What sort of proposition is: "On this strip you may see all shades of grey between black and white"? Here it looks at first glance as if we're talking about infinitely many shades.

Indeed, we are apparently confronted here by the paradox that we can, of course, only distinguish a finite number of shades, and naturally the distinction between them isn't infinitely slight, and yet we see a continuous transition.

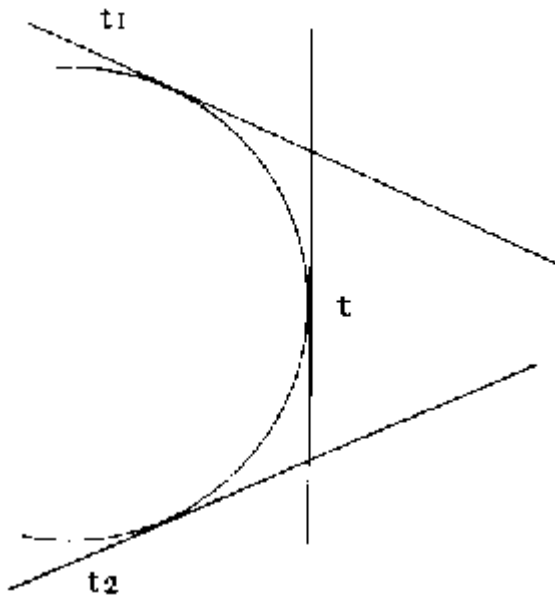

Page 253

It is just as impossible to conceive of a particular grey as being one of the infinitely many greys between black and white as it is to conceive of a tangent t as being one of the infinitely many transitional stages in going from t_1 to t_2 . If I see a ruler roll around the circle from t_1 to t_2 I see--if its motion is continuous--none of the intermediate positions in the sense in which I see t when the tangent is at rest; or else I see only a finite number of such positions. But if in such a case I appear to infer a particular case from a general proposition, then the general proposition is never derived from experience, and the proposition isn't a real proposition.

Page 253

If, e.g., I say "I saw the ruler move from t_1 to t_2 *therefore* I must have seen it at t " this doesn't [[sic]] give us a valid logical inference. That is, if what I mean is that the ruler must have *appeared* to me at t and so, if I'm talking about the position in visual space, then it doesn't

Page Break 254

in the least follow from the premise. But if I'm talking about the physical ruler, then of course it's possible for the ruler to have skipped over position t and yet for the phenomenon in visual space to have remained continuous.

Page Break 255

4

Can an experience show that one proposition follows from another?

Page 255

The only essential point is that we cannot say that it was through experience we were made aware of an extra application of grammar. For in making that statement we would have to describe the application, and even if this is the first time I have realised that the description is true I must have been able to understand it even before the experience.

Page 255

It is the old question: how far can one now speak of an experience that one is not now having?

Page 255

What I cannot foresee I can not foresee.

Page 255

And what I can now speak of, I can now speak of independently of what I *can't* now speak of.

Page 255

Logic just is always complex.

Page 255

"How can I know everything that's going to follow?" What I can know then, I can also know now.

Page 255

But are there general rules of grammar, or only rules for general signs?

Page 255

What kind of thing in chess (or some other game) would count as a general rule or a particular rule? Every

rule is general.

Page 255

Still, there is one kind of generality in the rule that $p \vee q$ follows from p and a different kind in the rule that every proposition of the form $p, \sim\sim p, \sim\sim\sim p...$ follows from $p.q$. But isn't the generality of the rule for the knight's move different from the generality of the rule for the beginning of a game?

Page 255

Is the word "rule" altogether ambiguous? So should we talk only about particular cases of rules, and stop talking about rules in general, and indeed about languages in general?

Page 255

"If $F_1(a)$ [= a has the colour F_1] entails $\sim F_2(a)$ then the possibility of the second proposition must have been provided for in the

Page Break 256

grammar of the first (otherwise how could we call F_1 and F_2 colours?)

Page 256

"If the second proposition as it were turned up without being expected by the first it couldn't possibly follow from it."

Page 256

"The first proposition must acknowledge the second as its consequence. Or rather they must be united in a single grammar which remains the same before and after the inference."

Page 256

(Here it is very difficult not to tell fairy tales about symbolic processes, just as elsewhere it is hard not to tell fairy tales about psychological processes. But everything is simple and familiar (there is nothing new to be discovered). That is the terrible thing about logic, that its extraordinary difficulty lies in the fact that nothing must be constructed, and everything is already present familiar.)

Page 256

"No proposition is a consequence of p unless p acknowledges it as its consequence."

Page 256

Whether a proposition entails another proposition must be clear from the grammar of the proposition and from that alone. It cannot be the result of any insight into a new sense: only of an insight into the old sense. It is not possible to construct a new proposition that follows from the old one which could not have been constructed (perhaps without knowing whether it was true or false) when the old one was constructed. If a new sense were discovered and followed from the first proposition, wouldn't that mean that that proposition had altered its sense?

Page Break 257

II GENERALITY

The proposition "The circle is in the square" is in a certain sense independent of the assignment of a particular position. (In a certain sense it is totally unconnected.)

Page 257

I would like to say: a general picture like $|0|$ does not have the same metric as a particular one.

Page 257

In the general sign " $|0|$ " the distances play no greater part than they do in the sign " aRb ".

Page 257

The drawing $|0|$ can be looked on as a representation of the "general case". It is as if it were not in a measurable space: the distances between the circle and the lines are of no consequence. The picture, taken thus, is not seen as occurring in the same system as when one sees it as the representation of a particular position of the circle between the lines. Or rather, taken thus, it is a part of a different calculus. The rules that govern variables are not the same as those that govern their particular values.

Page 257

"How do you know he is in the room?" "Because I put him in and there is no way he can get out." Then your knowledge of the general fact that he is somewhere in the room has the same multiplicity as that reason.

Page 257

Let us take the particular case of the general state of affairs of the cross being between the end-lines.

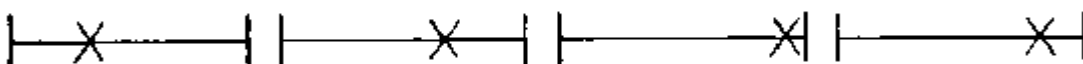

Each of these cases, for instance, has its own individuality. Is there any way in which this individuality enters into the sense of the general sentence? Obviously not.

'Being between the lines, or the walls' seems something simple and the particular positions (both the visual appearances and the

positions established by measurement) seem quite independent of it.

That is, when we talk about the individual (seen) positions we appear to be talking about something quite different from the topic of the general proposition.

There is one calculus containing our general characterization and another containing the disjunction. If we say that the cross is between the lines we don't have any disjunction ready to take the place of the general proposition.

If we consider a general proposition like "the circle is in the square" it appears time and again that the assignment of a position in the square is not (at least so far as visual space is concerned) a more precise specification of the statement that the circle is *in the square* any more than a statement of the colour of a material is a more precise specification of a statement of its hardness.--Rather, "in the square" appears a complete specification which in itself does not admit of any more precise description. Now of course the statements about the circle are not related to each other like the statements about colour and hardness, and yet that feeling is not baseless.

The grammatical rules for the terms of the general proposition must contain the multiplicity of possible particular cases provided for by the proposition. What isn't contained in the rules isn't provided for.

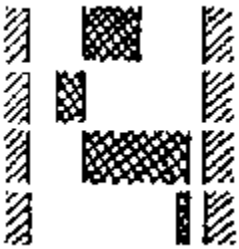

All these patterns might be the same state of affairs distorted. (Imagine the two white strips and the middle black strip as elastic.)

Does fa's following from (x). fx mean that a is mentioned in

(x). fx? Yes, if the general proposition is meant in such a way that its verification consists in an enumeration.

If I say "there is a black circle in the square", it always seems to me that here again I have something simple in mind, and don't have to think of different possible positions or sizes of the circle. And yet one may say: if there is a circle in the square, it must be somewhere and have some size. But in any case there cannot be any question of my thinking in advance of *all* the possible positions and sizes.--It is rather that in the first proposition I seem to put them through a kind of sieve so that "circle in a square" corresponds to a single impression, which doesn't take any account of the *where* etc., as if it were (against all appearance) something only physically, and not logically, connected with the first state of affairs.

The point of the expression "sieve" is this. If I look at a landscape or something similar through a glass which transmits only the distinction between brightness and darkness and not the distinctions between colours, such a glass can be called a sieve; and if one thinks of the square as being looked at through a glass which transmits only the distinction "circle in the square or not in the square" and no distinction between positions or sizes of the circle, here too we might speak of a sieve.

I would like to say that in the proposition "there is a circle in the square" the particular positions are not mentioned at all. In the picture I don't see the position, I disregard it, as if the distances from the sides of the square were elastic and their lengths of no account.

Page 259

Indeed, can't the patch actually be moving in the square? Isn't that just a special case of being in the square? So in that case it wouldn't be true that the patch has to be in a particular position in the square if it is there at all.

Page 259

I want to say that the patch seems to have a relation to the edge that is independent of its distance.--Almost as if I were using a

Page Break 260

geometry in which there is no such thing as distance, but only inside and outside. Looked at in this way, there is no

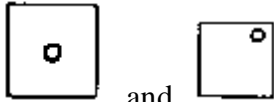

doubt that the two pictures and are the same.

Page 260

By *itself* the proposition "The patch is in the square" does no more than hold the patch in the square, as it were; it is only in this way that it limits the patch's freedom; within the square it allows it complete freedom. The proposition constructs a frame that limits the freedom of the patch but within the frame it leaves it free, that is, it *has nothing to do* with its position. For that to be so the proposition must have the logical nature of the frame (like a box enclosing the patch). And so it has, because I could explain the proposition to someone and set out the possibilities, quite independently of whether such a proposition is true or not, independently of a fact.

Page 260

"Wherever the patch is in the square..." means "as long as it is in the square..." and here all that is meant is the freedom (lack of restraint) in the square, not a set of positions.

Page 260

Of course between this freedom and the totality of possibilities, there is a logical similarity (formal analogy), and that is why the same words are often used in the two cases ("all", "every", etc.).

Page 260

"No degrees of brightness below this one hurt my eyes." Test the type of generality.

Page 260

"All points on this surface are white." How do you verify that?--then I will know what it means.

Page Break 261

6

The proposition "The circle is in the square" is not a disjunction of cases.

Page 261

If I say the patch is in the square, I know--and must know--that it may have various possible positions. I know too that I couldn't give a definite number of all such positions. I do not know in advance how many positions "I could distinguish".--And trying it out won't tell me what I want to know here either.

Page 261

The darkness veiling the possible positions etc. is the current logical situation, just as dim lighting is a particular sort of lighting.

Page 261

Here it always seems as if we can't quite get an overall view of a logical form because we don't know how many or what possible positions there are for the patch in the square. But on the other hand we do know, because we aren't surprised by any of them when they turn up.

Page 261

Of course "position of the circle in this square" isn't a concept which particular positions fall under as objects. You couldn't discover objects and ascertain that they were positions of the circle in the square which you didn't know about beforehand.

Page 261

Incidentally, the centre and other special positions in the circle are quite analogous to the primary colours on the colour scale. (This comparison might be pursued with profit.)

Page 261

Space is as it were a single possibility; it doesn't consist of several possibilities.

Page 261

So if I hear that the book is somewhere on the table, and then find it in a particular position, it isn't possible for me to be surprised and say "oh, I didn't know that there was this position"; and yet I hadn't foreseen this particular position i.e. envisaged it in

Page Break 262

advance a particular possibility. It is physical, not logical possibilities that take me by surprise!

Page 262

But what is the difference between "the book is somewhere on the table" and "the event will occur sometime in the future?" Obviously the difference is that in the one case we have a sure method of verifying whether the book is on the table, while in the other case there is no such method. If a particular event were supposed to occur at one of the infinitely many bisections of a line, or better, if it were supposed to occur when we cut the line at a single point, not further specified, and then waited a minute at that point, that statement would be as senseless as the one about the infinite future.

Page 262

Suppose I stated a disjunction of so many positions that it was impossible for me to see a single position as distinct from all those given; would *that* disjunction be the general proposition $(\exists x).fx$? Wouldn't it be a kind of pedantry to continue to refuse to recognize the disjunction as the general proposition? Or is there an essential distinction, and is the disjunction totally unlike the general proposition?

Page 262

What so strikes us is that the one proposition is so complicated and the other so simple. Or is the simple one only an abbreviation for the more complicated one?

Page 262

What then is the criterion for the general proposition, for the circle's being in the square? Either, nothing that has anything to do with a set of positions (or sizes) or something that deals with a finite number of such positions.

Page 262

If one says that the patch A is somewhere between the limits B and C, isn't it obviously possible to describe or portray a number of positions of A between B and C in such a way that I see the succession of all the positions as a continuous transition? And in

Page Break 263

that case isn't the disjunction of all those N positions the very proposition that A is somewhere between B and C?

Page 263

But what are these N pictures really like? It is clear that a picture must not be visually discernible from its immediate successor, or the transition will be discontinuous.

Page 263

The positions whose succession I see as a continuous transition are positions which are not in visual space.

Page 263

How is the extension of the concept "lying between" determined? Because it has to be laid down in advance what possibilities belong to this concept. As I say, it cannot be a surprise that I call *that* too "lying between". Or: how can the rules for the expression "lie between" be given when I can't enumerate the cases of lying between? Of course that itself must be a characteristic of the meaning of the expression.

Page 263

Indeed if we wanted to explain the word to someone we wouldn't try to do so by indicating *all particular instances*, but by showing him one or two such instances and intimating in some way that it wasn't a question of the particular case.

Page 263

It is not only that the enumeration of positions is unnecessary: in the nature of things there can be no question of such an enumeration here.

Page 263

Saying "The circle is either between the two lines or *here*" (where "here" is a place between the lines) obviously means no more than "The circle is between the two lines", and the rider "or here" is superfluous. You will say: the "here" is already included in the "somewhere". But that is strange, since it isn't mentioned in it.

Page 263

There is a particular difficulty when the signs don't appear to say what the thought grasps, or the words don't say what the thought appears to grasp.

Page Break 264

As when we say "this theorem holds of all numbers" and think that in our thought we have comprehended all numbers like apples in a box.

But now it might be asked: how can I know in advance which propositions entail this general proposition, if I can't specify the propositions?

But can one say "We can't say which propositions entail this proposition"? That sounds like: we don't know. But of course that isn't how it is. I can indeed say, and say in advance, propositions that entail it. "Only not *all* of them." But that just has no meaning.

There is just the general proposition and particular propositions (not *the* particular propositions). But the general proposition does not enumerate particular propositions. In that case what characterizes it as general, and what shows that it doesn't simply comprise the particular propositions we are speaking of in this particular case?

It cannot be characterized by its instantiations, because however many we enumerate, it could still be mistaken for the product of the cited cases. Its generality, therefore, lies in a property (a grammatical property) of the variables.

The inadequacy of the Frege-Russell notation for generality

The real difficulty lies in the concept of " $(\exists n)$ " and in general of " $(\exists x)$ ". The original source of this notation is the expression of our word-language: "There is a... with such and such properties". And here what replaces the dots is something like "book from my library" or "thing (body) in this room", "word in this letter", etc. We think of objects that we can go through one after the other. As so often happens a process of sublimation turned this form into "there is an object such that..." and here too people imagined originally the objects of the world as like 'objects' in the room (the tables, chairs, books, etc.), although it is clear that in many cases the grammar of this " $(\exists x)$, etc." is not at all the same as the grammar of the primitive case which serves as a paradigm. The discrepancy between the original picture and the one to which the notation is now applied becomes particularly palpable when a proposition like "there are two circles in this square" is rendered as "there is no object that has the property of being a circle in this square without being the circle a or the circle b" or "there are not three objects that have the property of being a circle in this square". The proposition "there are only two things that are circles in this square" (construed on the model of the proposition "there are only two men who have climbed this mountain") sounds crazy, with good reason. That is to say, nothing is gained by forcing the proposition "there are two circles in this square" into that form; it only helps to conceal that we haven't cleared up the grammar of the proposition. But at the same time the Russellian notation here gives an appearance of exactitude which makes people believe the problems are solved by putting the proposition into the Russellian form. (This is no less dangerous than using the word "probably" without further investigation into the use of the word in this particular case. For understandable reasons the word

"probably", too, is connected with an idea of exactitude.)

"One of the four legs of this table doesn't hold", "There are Englishmen with black hair", "There is a speck on this wall" "The two pots have the same weight", "There are the same number of words on each of the two pages". In all these cases in the Russellian notation the " $(\exists \dots)$..." is used, and each time with a different grammar. The point I want to make is that nothing much is gained by translating such a sentence from word-language into Russellian notation.

It makes sense to say "write down any cardinal number" but not "write down all cardinal numbers". "There is a circle in the square" $(\exists x).fx$ makes sense, but not $\sim \exists x.\sim fx$: "all circles are in the square." "There is a red circle on a background of a different colour" makes sense, but not "there isn't a background-colour other than red that doesn't have a red circle on it."

"In this square there is a black circle". If this proposition has the form " $(\exists x).x$ is a black circle in a square" what sort of thing is it that has the property of being a black circle (and so can also have the property of not being a

black circle)? Is it a place in the square? But then there is no proposition "(x).x is a black..." On the other hand the proposition could mean "There is a speck in the square that is a black circle". How is that proposition verified? Well, we take the different specks in the square in turn and investigate whether they are quite black and circular. But what kind of proposition is "There isn't a speck in the square"? For if in the former case the 'x' in '(∃x)' meant 'speck in the square', then though "(∃x).fx" is a possible proposition both "(∃x)" and "¬(∃x)" are not. Or again, I might ask: what sort of thing is it that has (or does not have) the property of being a speck in the square?

Page 266

And if we can say "There is a speck in the square" does it then also make sense to say "All specks are in the square"? All *which*?

Page Break 267

Page 267

Ordinary language says "In this square there is a red circle"; the Russellian notation says "There is an object which is a red circle in this square". That form of expression is obviously modelled on "There is a substance which shines in the dark" "There is a circle in this square which is red".--Perhaps even the expression "there is" is misleading. "There is" really means the same as "Among these circles there is one..." or "... there exists one...".

Page 267

So if we go as far as we can in the direction of the Russellian mode of expression and say "In this square there is a place where there is a red circle", that really means, among these places there is one where... etc.

Page 267

(In logic the most difficult standpoint is that of sound common sense. For in order to justify its view it demands the whole truth; it will not help by the slightest concession or construction.)

Page 267

The correct expression of this sort of generality is therefore the expression of ordinary language "There is a circle in the square", which simply leaves the position of the circle *open* (leaves it *undecided*). ("Undecided" is a correct expression, since there just *has not been* any decision.)

Page Break 268

8

Criticism of my former view of generality

Page 268

My view about general propositions was that $(\exists x).\phi x$ is a logical sum and that though its terms aren't enumerated *here*, they are capable of being enumerated (from the dictionary and the grammar of language).

Page 268

For if they can't be enumerated we don't have a logical sum. (A rule, perhaps, for the construction of logical sums).

Page 268

Of course, the explanation of $(\exists x).\phi x$ as a logical sum and of $(x).\phi x$ as a logical product is indefensible. It went with an incorrect notion of logical analysis in that I thought that some day the logical product for a particular $(x).\phi x$ would be found.--Of course it is correct that $(\exists x).\phi x$ behaves in some ways like a logical sum and $(x).\phi x$ like a product; indeed for *one* use of words "all" and "some" my old explanation is correct,--for instance for "all the primary colours occur in this picture" or "all the notes of the C major scale occur in this theme". But for cases like "all men die before they are 200 years old" my explanation is not correct. The way in which $(\exists x).\phi x$ behaves like a logical sum is expressed by its following from ϕa and from $\phi a \vee \phi b$, i.e. in the rules

$$\begin{aligned} (\exists x).\phi x:\phi a. &= .\phi a & \text{and} \\ (\exists x).\phi x:\phi a \vee \phi b. &= .\phi a \vee \phi b \end{aligned}$$

Page 268

From these rules Russell's fundamental laws follow as tautologies:

$$\begin{aligned} \phi x.\supset.(\exists z).\phi z \\ \phi x \vee \phi y.\supset.(\exists z).\phi z \end{aligned}$$

Page 268

For $(\exists x).\phi x$ we need also the rules:

$$(\exists x).\phi x \vee \psi x. = .(\exists x).\phi x.\vee.(\exists x).\psi x$$

$(\exists x,y)\phi x.\psi y.\vee.(\exists x).\phi x.\psi x. = .(\exists x).\phi x:(\exists x).\psi x.$

Page 268

Every such rule is an expression of the analogy between $(\exists x).\phi x$ and a logical sum.

Page Break 269

Page 269

Incidentally, we really could introduce a notation for $(\exists x).\phi x$ in which it was replaced by a sign " $\phi r \vee \phi s \vee \phi t...$ " which could then be used in calculation like a logical sum; but we would have to provide rules for reconverting this notation at any time into the " $(\exists x).\phi x$ " notation and thus distinguishing the sign " $\phi a \vee \phi b \vee \phi c...$ " from the sign for a logical sum. The point of this notation could simply be to enable us to calculate more easily with $(\exists x).\phi x$ in certain cases.

Page 269

If I am right, there is no concept "pure colour"; the proposition "A's colour is a pure colour" simply means "A is red, or yellow, or blue, or green". "This hat belongs either to A or B or C" is not the same proposition as "This hat belongs to a person in this room" even when in fact only A, B and C are in the room, for that itself is something that has to be added.--"On this surface there are two pure colours" *means*: on this surface there is red and yellow, or red and green, or... etc.

Page 269

If this means I can't say "there are 4 pure colours", still the pure colours and the number 4 are somehow connected with each other and that must express itself in some way.--For instance, I may say "on this surface I see 4 colours: yellow, blue, red, green".

Page 269

The generality notation of our ordinary language grasps the logical form even more superficially than I earlier believed. In this respect it is comparable with the subject-predicate form.

Page 269

Generality is as ambiguous as the subject-predicate form.

Page 269

There are as many different "alls" as there are different "ones".

Page 269

So it is no use using the word "all" for clarification unless we know its grammar in this particular case.

Page Break 270

9

The explanation of generality by examples

Page 270

Let us think how we explain the concept plant. We show someone several objects and say they are plants; then he points to another object and asks "is that a plant too?" and we reply "yes, that too" etc. I would once have said that he has now seen in what he has been shown the concept 'plant'--the common element--and that he does not see the examples used in the explanation in the same way when he sees the concept in them as when he views them just as representatives of a particular shape and colour or the like. (Just as I also used to say that when he understands variables as variables he sees something in them which he doesn't see in the sign for the particular case). But the notion of "seeing in" is taken from the case in which I see a figure like |||| differently "phrased". In that case, I really do see different figures, but in a different sense; and what these have in common, apart from their similarity, is their being caused by the same physical pattern.

Page 270

But this explanation cannot be applied without further ado to the case of the understanding of a variable or of the examples illustrating the concept "plant". For suppose we really had seen something in them that we don't see in plants that are shown only for their own sake, the question remains whether this, or any other, picture can entitle us to apply them as variables. I might have shown someone the plants by way of explanation and given him in addition a drug causing him to see the examples in the special way. (Just as it would be possible that a drunken man might always see a group like |||| as ||| |). And this would give the explanation of the concept in an unambiguous manner, and the specimens exhibited and the accompanying gestures would communicate to anyone who understood just *this* picture. But that is not the way it is.--It may well be true that someone who sees a sign like ||||| as a numeral for 6 sees it differently (sees something different in it) from someone who views it only as a

Page Break 271

sign for "some", since he fixes his attention on something different; but what matters is the system of rules

governing the signs, and it isn't seeing the signs in a particular manner that is the essence of understanding.

Page 271

It would be possible to say "now I don't see it as a rose, but as a plant".

Page 271

Or "now I see it only as a rose, and no longer as *this* rose".

Page 271

"I see the patch merely in the square and no longer in a specific position."

Page 271

The mental process of understanding is of no interest to us (any more than the mental process of an intuition).

Page 271

"Still, there's no doubt that someone who understands the examples as arbitrary cases chosen to illustrate the concept doesn't understand the same as a man who regards them as a definitely bounded enumeration." Quite right, but *what* does the first man understand that the second doesn't? Well, in the things he is shown he sees only *examples* to illustrate certain features; he doesn't think that I am showing him the things for their own sake as well.--

Page 271

I would like to call the one class "logically bounded" and the other "logically unbounded".

Page 271

Yes, but is it really true that he sees only these features in the things? In a leaf, say, does he see only what is common to all leaves? That would be as if he saw everything else blank like an uncompleted form with the essential features ready printed. (But the function "f(...)" is just such a form.)

Page 271

But what sort of a process is it when someone shows me several different things as examples of a concept to get me to see what is common to them, and when I look for it and then actually see it? He may *draw my attention* to what is common.--But by doing this

Page Break 272

does he make me *see* the object differently? Perhaps so; for surely I may take a special look at one of the parts, when otherwise I would have seen the whole with equal clarity. But this seeing is not the understanding of the concept. For what we see isn't something with an *empty* argument place.

Page 272

One might also ask: Does a man who regards the sign "|||..." as a sign for the concept of number (in contrast with "|||" to denote 3) see the first group of lines differently from the second? Even if he does see it differently (perhaps, as it were, more blurred) does he *see* there anything like the essence of the concept of number? Wouldn't that mean that he would actually have to be unable to distinguish "|||..." and "||||..." from each other? (As indeed he would, if I had given him some drug that made him see the *concept*.)

Page 272

For if I say: by giving us a few examples he makes us see the common element in them and disregard the rest, that really means that the rest falls into the background, as it were becomes paler (or altogether disappears--why not?) and "the common element", say the oval shape, remains alone in the foreground.

Page 272

But that isn't the way it is. Apart from anything else, the multiplicity of examples would be no more than a mechanical device, and once I had seen what I was supposed to, I could see it in a single example too. (As indeed '(\exists x).fx' itself contains only *one* example.)

Page 272

So it is the rules governing the example that make it an example.

Page 272

But by now at any rate, if someone says to me something like "make an egg shape" the bare concept word without any illustration suffices to make itself understood (and the past history of this understanding is of no interest to us); and I do not want to say that when I understand the command (and the word "egg") I see

Page Break 273

the concept of an egg before my mind's eye.

Page 273

When I make an application of the concept "egg" or "plant" there certainly isn't some general picture in front of my mind before I do so, and when I hear the word "plant" it isn't that there comes before my mind a picture of a certain object which I then describe as a plant. No, I make the application as it were spontaneously. Still, in the case

of certain applications I might say "No, I didn't mean that by 'plant'", or, "Yes, I meant that too". But does that mean that these pictures came before my mind and that mentally I expressly rejected and admitted them?--And yet that is what it looks like, when I say: "Yes, I meant all those things, but not *that*." But one might then ask: "But did you foresee all those cases?" and then the answer might be "yes" or "no, but I imagined there must be something between this form and that one" or the like. But commonly at that moment I did not draw any bounds, and they can only be produced in a roundabout way after reflection. For instance, I say "Bring me a flower about so big"; he brings one and I say: Yes, that is the size I meant. Perhaps I do remember a picture which came before my mind, but it isn't that that makes the flower that has been brought acceptable. What I am doing is making an application of the picture, and the application was not anticipated.

Page 273

The only thing of interest to us is the *exact* relationship between the example and the behaviour that accords with it.

Page 273

The example is the point of departure for further calculation.

Page 273

Examples are decent signs, not rubbish or hocus-pocus.

Page 273

The only thing that interests us is the geometry of the mechanism. (That means, the grammar of its description.)

Page 273

But how does it come out in our rules, that the instances of fx

Page Break 274

we are dealing with are not essentially closed classes?--Only indeed in the generality of the general rule.--How does it come out that they don't have the same significance for the calculus as a closed group of primitive signs (like the names of the 6 basic colours)? How else could it come out except in the rules given for them?--Suppose that in some game I am allowed to help myself to as many pieces as I like of a certain kind, while only a limited number of another kind is available; or suppose a game is unbounded in time but spatially bounded, or something similar. The case is exactly the same. The distinction between the two different types of piece in the game must be laid down in the rules; they will say about the one type that you can take as many pieces as you want of that kind. And I mustn't look for another more restrictive expression of that rule.

Page 274

That means that the expression for the unboundedness of the particular instances in question will be a general expression; there cannot be some other expression in which the other unconsidered instances appear in some shadowy way.

Page 274

It is clear that I do not recognize any logical sum as a definition of the proposition "the cross is between the lines". And that says everything that is to be said.

Page 274

There is one thing I always want to say to clarify the distinction between instances that are offered as examples for a concept and instances that make up a definite closed group in the grammar. Suppose, after explaining "a, b, c, d are books", someone says "Now bring me a book". If the person brings a book which isn't one of the ones shown him he can still be said to have acted correctly in accordance with the rule given. But if what had been said was "a, b, c, d, are my books.--Bring me one of my books", it would have been incorrect to bring a different one and he would have been told "I told you that a, b, c, d are my books". In the first case it isn't against the rule to bring an object other than those named,

Page Break 275

in the second case it is. But if in the order you named only a, b, c, and d, and yet you regarded the behaviour $f(e)$ as obeying the order, doesn't that mean that by $F(a, b, c, d, \dots)$ you meant $F(a, b, c, d, e)$ after all? Again, how are these orders distinct from each other if the same thing obeys both of them?--But $f(g)$ too would have been in accordance with the order and not only $f(e)$. Right, then your first order must have meant $F(a, b, c, d, e, g)$ etc. Whatever you bring me is something I could have included in a disjunction. So if we construct the disjunction of all the cases we actually use, how would it differ syntactically from the general proposition? For we can't say: by the fact that the general proposition is also made true by r (which doesn't occur in the disjunction), because that doesn't distinguish the general proposition from a disjunction which contains r . (And every other similar answer too is impossible.) But it will make sense to say: $F(a, b, c, d, e)$ is the disjunction of all the cases we have actually used, but there are also

other cases (we won't of course, mention any) that make true the general proposition "F(a, b, c, d,...)". And here of course we can't put the general proposition in place of F(a, b, c, d, e,).

Page 275

It is, by the way, a very important fact that the parenthesis in the previous paragraph "and every other similar answer too is impossible" is senseless, because though you can give as instances of a generalization different particular cases, you can't give different variables because the variables r, s, t don't differ in their meaning.

Page 275

Of course one couldn't say that when we do f(d) we don't obey f(\exists) in the same way as we obey a disjunction containing f(d), because $f(\exists) = f(\exists) \vee f(d)$. If you give someone the order "bring me some plant or other, or this one" (giving him a picture of it), he will simply discard the picture and say to himself "since any one will do, the picture doesn't matter". By contrast, we won't simply

Page Break 276

discard the picture if we are given it plus five others and the order to bring one of these six plants. (So what matters is *which* disjunction contains the particular command.) And you wouldn't be guided in the same way by the order "f(a) \vee f(b) \vee f(c)" as by the order "f(\exists)" (= $f(\exists) \vee f(c)$), even if in each case you do f(c).--The picture f(c) sinks into f(\exists). (It is no good sitting in a boat, if you and it are under water and sinking). Someone may be inclined to say: "Suppose you do f(c) on the command f(\exists); in that case f(c) might have been expressly permitted and then how would the general command have differed from a disjunction?"--But if the permission had occurred in a disjunction with the general sentence, you couldn't have *appealed* to it.

Page 276

So is this how it is: "bring me a flower" can never be replaced by an order of the form "bring me a or b or c", but must always be "bring me a or b or c *or some other flower*"?

Page 276

But why does the general sentence behave so indeterminately when every case which actually occurs is something I could have described in advance?

Page 276

But even that seems to me not to get to the heart of the matter; because what matters, I believe, isn't really the infinity of the possibilities, but a kind of indeterminacy. Indeed, if I were asked how many possibilities a circle in the visual field has of being within a particular square, I could neither name a finite number, nor say that there were infinitely many (as in a Euclidean plane). Here, although we don't ever come to an end, the series isn't endless in the way in which $|1, \xi, \xi + 1|$ is.

Page 276

Rather, no end to which we come is really the end; that is, I could always say: I don't understand why these should be all the possibilities.--And doesn't that just mean that it is senseless to speak of "all the possibilities"? So enumeration *doesn't touch* the concepts "plant" and "egg" at all.

Page Break 277

Page 277

And although we say that we could always have foreseen f(a) as a possible particular execution of the order, still we didn't in fact ever do so.--But even if I do foresee the possibility f(a) and expressly include it in my order, it gets lost beside the general proposition, because I can see from the general proposition itself that this particular case is permitted; it isn't just from its being expressly permitted in the order that I see this. If the general proposition is there, the addition of the particular case isn't any extra use to me (that is, it doesn't make the command more explicit). Indeed it was only the general proposition that gave me the justification for placing this particular case beside it. What my whole argument is aiming at, is that someone might believe that the addition of the particular case supersedes the--as it were blurred--generality of the proposition, that you could say "we don't need it any more, now we have the particular case." Yes, but say I admit that the reason I put in the particular case is that it agrees with the general proposition! Or suppose I admit that I recognize that f(a) is a particular case of f(\exists)! For I can't say: that just means that f(\exists) is a disjunction with f(a) as one of its terms; for if that is so, the disjunction must be capable of being stated, and f(\exists) must be defined as a disjunction. There would be no difficulty in giving such a definition, but it wouldn't correspond to the use of f(\exists) that we have in mind. It isn't that the disjunction always leaves something over; it is that it just doesn't touch the essential thing in generality, and even if it is added to it it depends on the general proposition for its justification.

Page 277

First I command f(\exists); he obeys the order and does f(a). Then I think that I could just as well have given him the command "f(\exists) \vee f(a)". (For I knew in advance that f(a) obeyed the order f(\exists) and to command him f(\exists) \vee f(a)

would come to the same.) In that case when he obeyed the order he would have been acting on the disjunction "do something or $f(a)$ ". And if he obeys the order

Page Break 278

by doing $f(a)$ isn't it immaterial what else is disjoined with $f(a)$? If he does $f(a)$ in any case, the order is obeyed whatever the alternative is.

Page 278

I would also like to say: in grammar nothing is supplementary, no stipulations come *after* others, everything is there simultaneously.

Page 278

Thus I can't even say that I first gave the command $f(\exists)$ and only later realised that $f(a)$ was a case of $f(\exists)$; at all events my order was and remained $f(\exists)$ and I added $f(a)$ to it in the knowledge that $f(a)$ was in accordance with $f(\exists)$. And the stipulation that $f(a)$ is in accordance with $f(\exists)$ presupposes the sense that belongs to the proposition $f(\exists)$ if it is taken as an independent unit and not defined as replaceable by a disjunction. And my proposition "at all events my order was and remained $f(\exists)$ etc." only means that I didn't replace the general order by a disjunction.

Page 278

Suppose I give the order $p \vee f(a)$, and the addressee doesn't clearly understand the first part of the order but does understand that the order goes "... $\vee f(a)$ ". He might then do $f(a)$ and say "I know for certain that I've obeyed the command, even though I didn't understand the first part". And that too is how I imagine it when I say that the other alternative doesn't matter. But in that case he didn't obey the order *that was given*, but simply treated it as " $f(a)$!" One might ask: if someone does $f(a)$ at the command " $f(\exists) \vee f(a)$ " is he obeying the order because (i.e. in so far as) the order is of the form $\xi \vee f(a)$, or because $f(\exists) \vee f(a) = f(\exists)$? If you understand $f(\exists)$ and therefore know that $f(\exists) \vee f(a) = f(\exists)$, then by doing $f(a)$ you are obeying $f(\exists)$ even if I write it " $f(\exists) \vee f(a)$ " because you can see *none the less* that $f(a)$ is a case of $f(\exists)$. And now someone might object: if you see that Fa is a case of $F(\exists)$ that just means that $f(a)$ is contained disjunctively in $f(\exists)$, and therefore that $f(\exists)$ is defined *by means of* $f(a)$. The remaining parts of the disjunction--he will have to say--don't concern me because the terms I see are the only ones I now need.--By explaining 'that $f(a)$ is an instance of $f(\exists)$ ' you have said no more than that $f(a)$ occurs in $f(\exists)$ alongside certain other terms.--But that is precisely what we don't mean. It isn't as if our stipulation was an *incomplete definition* of $f(\exists)$;

Page Break 279

for that would mean that a complete definition was *possible*. That would be the disjunction which would make the addition " $\vee f(\exists)$ " as it were ridiculous, since it would only be the enumerated instances which concerned us. But according to our idea of $f(\exists)$, the stipulation that $f(a)$ is a case of $f(\exists)$ is not an incomplete definition of $f(\exists)$; it is not a definition of $f(\exists)$ at all. That means that I don't approximate to the sense of $f(\exists)$ by multiplying the number of cases in the disjunction; though the disjunction of the cases $\vee f(\exists)$ is equivalent to $f(\exists)$, it is never equivalent to the disjunction of the cases alone; it is a totally different proposition.

Page 279

What is said about an enumeration of individual cases cannot ever be a roundabout explanation of generality.

Page 279

But can I give the rules of entailment that hold in this case? How do I know that $(\exists x).fx$ does follow from fa ? After all I can't give *all* the propositions from which it follows.--But that isn't necessary; if $(\exists x).fx$ follows from fa , *that* at any rate was something that could be known in advance of any particular experience, and stated in the grammar.

Page 279

I said "in advance of any experience it was possible to know and to state in the grammar that $(\exists x).fx$ follows from fa ". But it should have been: ' $(\exists x).fx$ follows from fa ' is not a proposition (empirical proposition) of the language to which ' $(\exists x).fx$ ' and ' fa ' belong; it is a rule laid down in their grammar.

Page Break 280

Page 280

We can of course set up a rule for the use of the variables, and the fact that in order to do so we need the same kind of variable does not make it pleonastic. For if we didn't use it, then the variable would be defined by the rules, and we don't assume that it can be defined, or that it must be defined (for sooner or later definitions come to an end).

Page 280

This means only that--e.g.--the variable "x²" is not an abbreviation (say for a logical sum), and that in our thought too there is only a sign for this multiplicity.

Page 280

For suppose I had enumerated 7 particular instances and said "but their logical sum isn't the general proposition" that still wouldn't be enough; and I want to say further that no other number of instances yields the general proposition either. But in this rider once again I seem to go through an enumeration, in a kind of shadowy manner if not in actuality. But that is not the way it is, because the words that occur in the rider are quite different from the numerals.

Page 280

"But how can I forbid a particular numeral to be inserted in such and such a place? I surely can't foresee what number someone will want to insert, so that I can forbid it". You can forbid it when it comes.--But here we are already speaking of the general concept of number!

Page 280

But what makes a sign an expression of infinity? What gives the peculiar character that belongs to what we call infinite? I believe that it is like the case of a sign for an enormous number. For the characteristic of the infinite, conceived in this way, is its enormous size.

Page 280

But there isn't anything that is an enumeration and yet not an enumeration; a generality that enumerates in a cloudy kind of

Page Break 281

way without really enumerating or enumerating to a determined limit.

Page 281

The dots in "1 + 1 + 1 + 1..." are just the four dots: a sign, for which it must be possible to give certain rules. (The same rules, in fact, as for the sign "and so on ad inf.") This sign does in a manner ape enumeration, but it isn't an enumeration. And that means that the rules governing it don't totally agree with those which govern an enumeration; they agree only up to a point.

Page 281

There is no third thing between the particular enumeration and the general sign.

Page 281

Of course the natural numbers have only been written down up to a certain highest point, let's say 10¹⁰. Now what constitutes the *possibility* of writing down numbers that have not yet been written down? How odd is this feeling that they are all somewhere already in existence! (Frege said that before it was drawn a construction line was in a certain sense already there.)

Page 281

The difficulty here is to fight off the thought that possibility is a kind of shadowy reality.

Page 281

In the rules for the variable *a* a variable *b* may occur and so may particular numerals; but not any totality of numbers.

Page 281

But now it seems as if this involved *denying the existence* of something in logic: perhaps generality itself, or what the dots indicate; whatever is incomplete (loose, capable of further extension) in the number series. And of course we may not and cannot deny the existence of anything. So how does this indeterminacy find expression? Roughly thus: if we introduce numbers substitutable for the variable *a*, we don't say of any of them that it is the last, or the highest.

Page Break 282

Page 282

But suppose someone asked us after the explanation of a form of calculation "and is 103 the last sign I can use?" What are we to answer? "No, it isn't the last" or "there isn't a last?" Mustn't I ask him in turn "If it isn't the last, what would come next?" And if he then says "104" I should say "Quite right, you can continue the series yourself".

Page 282

Of an end to the possibility, I cannot speak at all.

Page 282

(In philosophy the one thing we must guard against is waffle. A rule that can be applied in practice is always in order.)

It is clear that we can follow a rule like $|a, \xi, \xi + 1|$. I mean by really following the rule for constructing it without previously being able to write down the series. In that case it's the same as if I were to begin a series with a number like 1 and then say "now add 7, multiply by 5, take the square root of the result, and always apply this complex operation once again to the result". (That would be the rule $|1, \xi, \sqrt{(\xi + 7) \cdot 5}|$.)

The expression "and so on" is nothing but the *expression* "and so on" (nothing, that is, but a sign in a calculus which can't do more than have meaning via the rules that hold of it; which can't say more than it shows).

That is, the expression "and so on" does not harbour a secret power by which the series is continued without being continued.

Of course it doesn't contain *that*, you'll say, but still it contains the meaning of infinite continuation.

But we might ask: how does it happen that someone who now applies the general rule to a further number is still following *this* rule? How does it happen that no further rule was necessary

to allow him to apply the general rule to this case in spite of the fact that this case was not mentioned in the general rule?

And so we are puzzled that we can't bridge over this abyss between the individual numbers and the general proposition.

"Can one imagine an empty space?" (Surprisingly, this is where this question belongs.)

It is one of the most deep rooted mistakes of philosophy to see possibility as a shadow of reality.

But on the other hand it can't be an error; not even if one calls the proposition such a shadow.

Here again, of course, there is a danger of falling into a *positivism*, of a kind which deserves a special name, and hence of course must be an error. For we must avoid accepting party lines or particular views of things; we must not disown anything that anyone has ever said on the topic, except where he himself had a particular view or theory.

For the sign "and so on", or some sign corresponding to it, is essential if we are to indicate endlessness--through the rules, of course, that govern such a sign. That is to say, we can distinguish the limited series "1, 1 + 1, 1 + 1 + 1" from the series "1, 1 + 1, 1 + 1 + 1 and so on". And this last sign and its use is no less essential for the calculus than any other.

What troubles me is that the "and so on" apparently has to occur also in the rules for the sign "and so on". For instance, 1, 1 + 1 and so on. = 1, 1 + 1, 1 + 1 + 1 and so on, *and so on*.

But then isn't this simply the old point that we can describe language only from the outside? So that we can't expect by describing language to penetrate to depths deeper than language

itself reveals: for it is by means of language that we describe language.

We might say: there's no occasion to be afraid of our using the expression "and so on" in a way that transcends the finite.

Moreover, the distinctive part of the grammar of "and so on" can't consist in rules connecting "and so on" with particular numerals (not *the* particular numerals)--for these rules in turn mention some bit of a series--but in rules connecting "and so on" with "and so on".

The possibility of introducing further numbers. The difficulty seems to be that the numbers I've in fact introduced aren't a group that is essential and yet there is nothing to indicate that they are an *arbitrary* collection:

Out of all numbers just those numbers that happen to have been written down.

Page 284
(As if I had all the pieces of a game in a box and a chance selection from the box on the table beside it.

Page 284
Or, as if one lot of numerals was traced in ink, while all of them are as it were drawn faintly in advance.)

Page 284
But apart from the ones we happen to have used we have only the general form.

Page 284
Isn't it here, by the way,--odd as it may sound--that the distinction between numerals and numbers comes?

Page 284
Suppose, for example, I say "By 'cardinal number' I mean whatever results from 1 by continued addition of 1". The word "continued" doesn't represent a nebulous continuation of 1, 1 + 1, 1 + 1 + 1; on the contrary the sign "1, 1 + 1, 1 + 1 + 1..." is to be taken as perfectly exact; governed by definite rules which are different from those for "1, 1 + 1, 1 + 1 + 1", and not a substitute for a series "which cannot be written down".

Page Break 285

Page 285
In other words: we calculate with the sign "1, 1 + 1, 1 + 1 + 1 ..." just as with the numerals, but in accordance with different rules.

Page 285
But what is it then that we imagine? What is the mistake we make? What kind of thing do we take the sign "1, 1 + 1..." to be? That is: where does what we think we see in this sign *really* occur? Something like when I say "he counted 1, 2, 3, 4 and so on up to 1000", where it would also be possible really to write down all the numbers.

Page 285
What do we *see* "1, 1 + 1, 1 + 1 + 1 ..." as?

Page 285
As an inexact form of expression. The dots are like extra numerals indistinctly visible. It is as if we stopped writing numerals, because after all we can't write them all down, but as if they are there all right in a kind of box. Again, it is something like when I sing only the first notes of a melody distinctly, and then merely hint at the rest and let it taper off into nothing. (Or when in writing one writes only a few letters of a word distinctly and ends with an unarticulated line.) *In all such cases the 'indistinctly' has a 'distinctly' corresponding to it.*

Page 285
I once said that there couldn't be both numbers *and* the concept of number. And that is quite correct, if it means that a variable doesn't have the same relation to a number as the concept apple has to an apple (or the concept sword to Nothung [[sic]]).

Page 285
On the other hand, *a number-variable is not a numeral.*

Page 285
But I also wanted to say that the concept of number couldn't be given independently of the numbers, and that isn't true. A number-variable is independent of particular numbers in the sense that there does exist a calculus with a class of our numerals and without the general number-variable. In that calculus, of course, not all the rules which hold of our numerals will be valid, but those numerals will correspond to ours in the way that the draughtsmen in draughts correspond to those in losing draughts.

Page 285
What I am opposing is the view that the infinite number series is

Page Break 286

something given concerning which there are both particular number theorems and also general theorems about all numbers of the series; so that the arithmetical calculus wouldn't be complete if it didn't contain the general theorems about cardinal numbers, i.e. general equations of the form $a + (b + c) = (a + b) + c$. Whereas even $1/3 = 0.\dot{3}$ belongs to a different calculus from $1/3 = 0 \cdot 3$. And similarly a general sign-rule (e.g. a recursive definition) that holds for 1, (1) + 1, ((1) + 1) + 1, (((1) + 1) + 1) + 1, and so on is something different from a particular definition. The general rule adds to the number calculus something extra, without which it would have been no less complete than the arithmetic of the number series 1, 2, 3, 4, 5.

Page 286
The question also arises: where is the concept of number (or of cardinal number) indispensable? Number, in

contrast to what? $|/ 1, \xi, \xi + 1|$, perhaps, in contrast to $|5, \sqrt{5}|$ etc.--For if I really do introduce such a sign (like $|1, \xi, \xi + 1|$) and don't just take it along as a luxury, then I must do something with it, i.e. use it in a calculus, and then it loses its solitary splendour and occurs in a system of signs coordinated with it.

Page 286

You will perhaps say: but surely "cardinal number" is contrasted with "rational number", "real number", etc. But this distinction is a distinction between the rules (the rules of the appropriate game)--not a distinction between positions on the chessboard--not a distinction demanding different coordinated words in the same calculus.

Page 286

We say "this theorem is proved for all cardinal numbers". But let us just see how the concept of cardinal numbers enters into the proof. Only because 1 and the operation $\xi + 1$ are spoken of in the proof--not in contrast to anything the rational numbers have. So if we use the concept-word "cardinal number" to describe the proof in prose, we see--don't we?--that no *concept* corresponds to that word.

Page Break 287

Page 287

The expressions "the cardinal numbers", "the real numbers", are extraordinarily misleading except where they are used to help specify particular numbers, as in "the cardinal numbers from 1 to 100", etc. There is no such thing as "the cardinal numbers", but only "cardinal numbers" and the concept, the form "cardinal number". Now we say "the number of the cardinal numbers is smaller than the number of the real numbers" and we imagine that we could perhaps write the two series side by side (if only we weren't weak humans) and then the one series would end in endlessness, whereas the other would go on beyond it into the actual infinite. But this is all nonsense. If we can talk of a relationship which can be called by analogy "greater" and "smaller", it can only be a relationship between the forms "cardinal number" and "real number". I learn what a series is by having it explained to me and only to the extent that it is explained to me. A finite series is explained to me by examples of the type 1, 2, 3, 4, and infinite one by signs of the type "1, 2, 3, 4, and so on" or "1, 2, 3, 4..."

Page 287

It is important that I can understand (see) the rule of projection without having it in front of me in a general notation. I can detect a general rule in the series $1/1, 2/4, 3/9, 4/16$ --of course I can detect any number of others too, *but still I can detect a particular one*, and that means that this series was somehow for me the expression of that one rule.

Page 287

If you have "intuitively" understood the law of a series, e.g. the series m , so that you are able to construct an arbitrary term $m(n)$, then you've completely understood the law, just as well as anything like an algebraic formulation could convey it. That is, no such formulation can now make you understand it better, and therefore to that extent no such formulation is any more rigorous, although it may of course be easier to take in.

Page 287

We are inclined to believe that the notation that gives a series by writing down a few terms plus the sign "and so on" is essentially inexact, by contrast with the specification of the general term.

Page Break 288

Page 288

Here we forget that the general term is specified by reference to a basic series which cannot in turn be described by a general term. Thus $2n + 1$ is the general term of the odd numbers, *if* n ranges over the cardinal numbers, but it would be nonsense to say that n was the general term of the series of cardinal numbers. If you want to define that series, you can't do it by specifying "the general term n ", but of course only by a definition like "1, 1 + 1, 1 + 1 + 1 and so on". And of course there is no essential difference between that series and "1, 1 + 1 + 1, 1 + 1 + 1 + 1 and so on", which I could just as well have taken as the basic series (so that then the general term of the cardinal number series would have been $\frac{1}{2}(n-1)$.)

$$(\exists x).\phi x: \sim(\exists x, y).\phi x.\phi y$$

$$(\exists x, y).\phi x.\phi y: \sim(\exists x, y, z).\phi x.\phi y.\phi z$$

$$(\exists x, y, z).\phi x.\phi y.\phi z: \sim(\exists x, y, z, u).\phi x.\phi y.\phi z.\phi u$$

"How would we now go about writing the general form of such propositions? The question manifestly has a good sense. For if I write down only a few such propositions as examples, you understand what the *essential element* in these propositions is meant to be."

Page 288

Well, in that case the row of examples is already a notation: for understanding the series consists in our

applying the symbol, and distinguishing it from others in the same system, e.g. from

- ($\exists x$). ϕx
- ($\exists x, y, z$). $\phi x.\phi y.\phi z$
- ($\exists x, y, z, u, v$). $\phi x.\phi y.\phi z.\phi u.\phi v$

Page 288

But why shouldn't we write the general term of the first series thus:

$$(\exists x_1 \dots x_n) \cdot \prod_{x_1}^{x_n} \phi x \cdot (\exists x_1 \dots x_{n+1}) \cdot \prod_{x_1}^{x_{n+1}} \phi x \quad ?\dagger 1$$

Page 288

Is this notation inexact? It isn't supposed by itself to make anything graphic; all that matters are the rules for its use, the system in which it is used. The scruples attaching to it date from a train of thought which was concerned with the number of primitive signs in the calculus of *Principia Mathematica*.

Page Break 289

III FOUNDATIONS OF MATHEMATICS

11

The comparison between mathematics and a game

Page 289

What are we taking away from mathematics when we say it is only a game (or: it is a game)?

Page 289

A game, in contrast to what?--What are we awarding to mathematics if we say it isn't a game, its propositions have a sense?

Page 289

The sense outside the proposition.

Page 289

What concern is it of ours? Where does it manifest itself and what can we do with it? (To the question "what is the sense of this proposition?" the answer is a proposition.)

Page 289

("But a mathematical proposition does express a thought."--What thought?--.)

Page 289

Can it be expressed by another proposition? Or only by *this* proposition?--Or not at all? In that case it is no concern of ours.

Page 289

Do you simply want to distinguish mathematical propositions from other constructions, such as hypotheses? You are right to do so: there is no doubt that there is a distinction.

Page 289

If you want to say that mathematics is played like chess or patience, and the point of it is like winning or coming out, that is manifestly incorrect.

Page 289

If you say that the mental processes accompanying the use of mathematical symbols are different from those accompanying chess, I wouldn't know what to say about that.

Page 289

In chess there are some positions that are impossible although each individual piece is in a permissible position. (E.g. if all the pawns are still in their initial position, but a bishop is already in

Page Break 290

play.) But one could imagine a game in which a record was kept of the number of moves from the beginning of the game and then there would be certain positions which could not occur after n moves and yet one could not read off from a position by itself whether or not it was a possible nth position.

Page 290

What we do in games must correspond to what we do in calculating. (I mean: it's there that the correspondence must be, or again, that's the way that the two must be correlated with each other.)

Page 290

Is mathematics about signs on paper? No more than chess is about wooden pieces.

Page 290

When we talk about the sense of mathematical propositions, or what they are about, we are using a false picture. Here too, I mean, it looks as if there are inessential, arbitrary signs which have an essential element in common, namely the sense.

Page 290

Since mathematics is a calculus and hence isn't really *about* anything, there isn't any metamathematics.

Page 290

What is the relation between a chess problem and a game of chess?--It is clear that chess problems correspond to arithmetical problems, indeed that they are arithmetical problems.

Page 290

The following would be an example of an arithmetical game: We write down a four-figure number at random, e.g. 7368; we are to get as near to this number as possible by multiplying the numbers 7, 3, 6, 8 with each other in any order. The players calculate with pencil and paper, and the person who comes nearest to the number 7368 in the smallest number of steps wins. (Many mathematical puzzles, incidentally, can be turned into games of this kind.)

Page 290

Suppose a human being had been taught arithmetic only for use in an arithmetical game: would he have learnt something different from a person who learns arithmetic for its ordinary use? If he multiplies 21 by 8 in the game and gets 168, does he do something

Page Break 291

different from a person who wanted to find out how many 21×8 is?

Page 291

It will be said: the one wanted to find out a truth, but the other did not want to do anything of the sort.

Page 291

Well, we might want to compare this with a game like tennis. In tennis the player makes a particular movement which causes the ball to travel in a particular way, and we can view his hitting the ball either as an experiment, leading to the discovery of a particular truth, or else as a stroke with the sole purpose of winning the game.

Page 291

But this comparison wouldn't fit, because we don't regard a move in chess as an experiment (though that too we might do); we regard it as a step in a calculation.

Page 291

Someone might perhaps say: In the arithmetical game we do indeed do the multiplication $(21 \times 8)/168$, but the equation $21 \times 8 = 168$ doesn't occur in the game. But isn't that a superficial distinction? And why shouldn't we multiply (and of course divide) in such a way that the equations were written down as equations?

Page 291

So one can only object that in the game the equation is not a proposition. But what does that mean? How does it become a proposition? What must be added to it to make it a proposition?--Isn't it a matter of the use of the equation (or of the multiplication)?--And it is certainly a piece of mathematics when it is used in the transition from one proposition to another. And thus the specific difference between mathematics and a game gets linked up with the concept of proposition (not 'mathematical proposition') and thereby loses its actuality for us.

Page 291

But one could say that the real distinction lay in the fact that in the game there is no room for affirmation and negation. For

Page Break 292

instance, there is multiplication and $21 \times 8 = 148$ would be a false move, but " $(21 \times 8 = 148)$ ", which is a correct arithmetical proposition, would have no business in our game.

Page 292

(Here we may remind ourselves that in elementary schools they never work with inequations. The children are only asked to carry out multiplications correctly and never--or hardly ever--asked to prove an inequation.)

Page 292

When I work out 21×8 in our game the steps in the calculation, at least, are the same as when I do it in order to solve a practical problem (and we could make room in a game for inequations also). But my attitude to the sum in other respects differs in the two cases.

Now the question is: can we say of someone playing the game who reaches the position " $21 \times 8 = 168$ " that he has found out that 21×8 is 168? What does he lack? I think the only thing missing is an application for the sum.

Calling arithmetic a game is no more and no less wrong than calling moving chessmen according to chess-rules a game; for that might be a calculation too.

So we should say: No, the word "arithmetic" is not the name of a game. (That too of course is trivial)--But the meaning of the word "arithmetic" can be clarified by bringing out the relationship between arithmetic and an arithmetical game, or between a chess problem and the game of chess.

But in doing so it is *essential* to recognize that the relationship is not the same as that between a tennis problem and the game of tennis.

By "tennis problem" I mean something like the problem of returning a ball in a particular direction in given circumstances. (A billiard problem would perhaps be a clearer case.) A billiard problem isn't a mathematical problem (although its solution may be an application of mathematics). A billiard problem is a physical

problem and therefore a "problem" in the sense of physics; a chess problem is a mathematical problem and so a "problem" in a different sense, a mathematical sense.

In the debate between "formalism" and "contentful mathematics" what does each side assert? This dispute is so like the one between realism and idealism in that it will soon have become obsolete, for example, and in that both parties make unjust assertions at variance with their day-to-day practice.

Arithmetic *isn't* a game, it wouldn't occur to anyone to include arithmetic in a list of games played by human beings.

What constitutes winning and losing in a game (or success in patience)? It isn't of course, just the winning position. A special rule is needed to lay down who is the winner. ("Draughts" and "losing draughts" differ only in this rule.)

Now is the rule which says "The one who first has his pieces in the other one's half is the winner" a statement? How would it be verified? How do I know if someone has won? Because he is pleased, or something of the kind? Really what the rule says is: you must try to get your pieces as soon as possible, etc.

In this form the rule connects the game with life. And we could imagine that in an elementary school in which one of the subjects taught was chess the teacher would react to a pupil's bad moves in exactly the same way as to a sum worked out wrongly.

I would almost like to say: It is true that in the game there isn't any "true" and "false" but then in arithmetic there isn't any "winning" and "losing".

I once said that it was imaginable that wars might be fought on a kind of huge chessboard according to the rules of chess. But if everything really went simply according to the rules of chess, then you wouldn't need a battlefield for the war, it could be played on an ordinary board; and then it wouldn't be a war in the ordinary sense. But you really could imagine a battle conducted in accordance with the rules of chess--if, say, the "bishop" could fight with the "queen" only when his position in relation to her was such that he would be allowed to "take" her in chess.

Could we imagine a game of chess being played (i.e. a complete set of chess moves being carried out) in such *different surroundings* that what happened wasn't something we could call the playing of a game?

Certainly, it might be a case of the two participants collaborating to solve a *problem*. (And we could easily

construct a case on these lines in which such a task would have a utility).

Page 294

The rule about winning and losing really just makes a distinction between two poles. It is not concerned with what later happens to the winner (or loser)--whether, for instance, the loser has to pay anything.

Page 294

(And similarly, the thought occurs, with "right" and "wrong" in sums.)

Page 294

In logic the same thing keeps happening as happened in the dispute about the nature of definition. If someone says that a definition is concerned only with signs and does no more than substitute one sign for another, people resist and say that that isn't *all* a definition does, or that there are different kinds of definition and the interesting and important ones aren't the mere "verbal definitions".

Page 294

They think, that is, that if you make definition out to be a mere substitution rule for signs you take away its significance and importance. But the *significance* of a definition lies in its application, in its importance for life. The same thing is happening today in the

Page Break 295

dispute between formalism and intuitionism, etc. People cannot separate the importance, the consequences, the application of a fact from the fact itself; they can't separate the description of a thing from the description of its importance.

Page 295

We are always being told that a mathematician works by instinct (or that he doesn't proceed mechanically like a chessplayer or the like), but we aren't told what that's supposed to have to do with the nature of mathematics. If such a psychological phenomenon does play a part in mathematics we need to know how far we can speak about mathematics with complete exactitude, and how far we can only speak with the indeterminacy we must use in speaking of instincts etc.

Page 295

Time and again I would like to say: What *I* check is the *account books* of mathematicians; their mental processes, joys, depressions and instincts as they go about their business may be important in other connections, but they are no concern of mine.

Page Break 296

12

There is no metamathematics.

Page 296

No calculus can decide a philosophical problem.

Page 296

A calculus cannot give us information about the foundations of mathematics.

Page 296

So there can't be any "leading problems" of mathematical logic, if those are supposed to be problems whose solution would at long last give us the right to do arithmetic as we do.

Page 296

We can't wait for the lucky chance of the solution of a mathematical problem.

Page 296

I said earlier "calculus is not a mathematical concept"; in other words, the word "calculus" is not a chesspiece that belongs to mathematics.

Page 296

There is no need for it to occur in mathematics.--If it is used in a calculus nonetheless, that doesn't make the calculus into a metacalculus; in such a case the word is just a chessman like all the others.

Page 296

Logic isn't metamathematics either; that is, work within the logical calculus can't bring to light essential truths *about* mathematics. Cf. here the "decision problem" and similar topics in modern mathematical logic.

Page 296

(Through Russell and Whitehead, especially Whitehead, there entered philosophy a false exactitude that is the worst enemy of real exactitude. At the bottom of this there lies the erroneous opinion that a calculus could be the mathematical foundation of mathematics.)

Page 296

Number is not at all a "fundamental mathematical concept"†1.

Page Break 297

There are so many calculations in which numbers aren't mentioned.

Page 297

So far as concerns arithmetic, what we are willing to call numbers is more or less arbitrary. For the rest, what we have to do is to describe the calculus--say of cardinal numbers--that is, we must give its rules and by doing so we lay the foundations of arithmetic.

Page 297

Teach it to us, and then you have laid its foundations.

Page 297

(Hilbert sets up rules of a particular calculus as rules of metamathematics.)

Page 297

A system's being *based on* first principles is not the same as its being developed from them. It makes a difference whether it is like a house resting on its lowest walls or like a celestial body floating free in space which we have begun to build beneath although we might have built anywhere else.

Page 297

Logic and mathematics are not *based on* axioms, any more than a group is based on the elements and operations that define it. The idea that they are involves the error of treating the intuitiveness, the self-evidence, of the fundamental propositions as a criterion for correctness in logic.

Page 297

A foundation that stands on nothing is a bad foundation.

Page 297

$(p.q) \vee (p.\sim q) \vee (\sim p.q) \vee (\sim p.\sim q)$: That is my tautology, and then I go on to say that every "proposition of logic" can be brought into this form in accordance with specified rules. But that means the same as: can be derived from it. This would take us as far as the Russellian method of demonstration and all we add to it

Page Break 298

is that this initial form is not itself an independent proposition, and that like all other "laws of logic" it has the property that $p.\text{Log} = p$, $p \vee \text{Log} = \text{Log}$.

Page 298

It is indeed the essence of a "logical law" that when it is conjoined with any proposition it yields that proposition. We might even begin Russell's calculus with definitions like

$$p \supset p.q. = .q$$
$$p:p \vee q. = .p, \text{ etc.}$$

Page Break 299

Page 299

If we prove that a problem can be solved, the concept "solution" must occur somewhere in the proof. (There must be something in the mechanism corresponding to the concept.) But the concept cannot have an external description as its proxy; it must be genuinely spelt out.

Page 299

The only proof of the provability of a proposition is a proof of the proposition itself. But there is something we might call a proof of relevance: an example would be a proof convincing me that I *can* verify the equation $17 \times 38 = 456$ before I have actually done so. Well, how is it that I know that I can check $17 \times 38 = 456$, whereas I perhaps wouldn't know, merely by looking, whether I could check an expression in the integral calculus? Obviously, it is because I know that the equation is constructed in accordance with a definite rule and because I know the kind of connection between the rule for the solution of the sum and the way in which the proposition is put together. In that case a proof of relevance would be something like a formulation of the general method of doing things like multiplication sums, enabling us to recognize the general form of the propositions it makes it possible to check. In that case I can say I recognise that this method will verify the equation without having actually carried out the verification.

Page 299

When we speak of proofs of relevance (and other similar mathematical entities) it always looks as if in addition to the particular series of operations called proofs of relevance, we had a quite definite inclusive concept of such proofs or of mathematical proof in general; but in fact the word is applied with many different, more or less related, meanings. (Like words such as "people", "king", "religion", etc.; cf Spengler.) Just think of the role of examples in the explanation of such words. If I want to explain what I mean by "proof", I will have to point to examples of proofs,

Page Break 300

just as when explaining the word "apple" I point to apples. The definition of the word "proof" is in the same case as the definition of the word "number". I can define the expression "cardinal number" by pointing to examples of cardinal numbers; indeed instead of the expression I can actually use the sign "1, 2, 3, 4, and so on ad inf". I can define the word "number" too by pointing to various kinds of number; but when I do so I am not circumscribing the concept "number" as definitely as I previously circumscribed the concept cardinal number, unless I want to say that it is only the things at present called numbers that constitute the concept "number", in which case we can't say of any new construction that it constructs a kind of number. But the way we want to use the word "proof" in is one in which it isn't simply defined by a disjunction of proofs currently in use; we want to use it in cases of which at present we "can't have any idea". To the extent that the concept of proof is *sharply* circumscribed, it is only through particular proofs, or through series of proofs (like the number series), and we must keep that in mind if we want to speak absolutely precisely about proofs of relevance, of consistency etc.

Page 300

We can say: A proof of relevance *alters* the calculus containing the proposition to which it refers. It cannot *justify* a calculus containing the proposition, in the sense in which carrying out the multiplication 17×23 justifies the writing down of the equation $17 \times 23 = 391$. Not, that is, unless we expressly give the word "justify" that meaning. But in that case we mustn't believe that if mathematics lacks this justification, it is in some more general and widely established sense illegitimate or suspicious. (That would be like someone wanting to say: "the use of the expression 'pile of stones' is fundamentally illegitimate, until we have laid down officially how many stones make a pile." Such a stipulation would modify the use of the word "pile" but it wouldn't "justify" it in any generally recognized sense; and if such an official definition were given, it wouldn't mean that the use earlier made of the word would be stigmatized as incorrect.)

Page Break 301

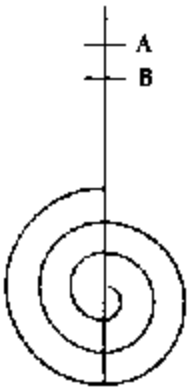

Page 301

The proof of the verifiability of $17 \times 23 = 391$ is not a "proof" in the same sense of the word as the proof of the equation itself. (A cobbler heels, a doctor heals: both...) We grasp the verifiability of the equation from its proof somewhat as we grasp the verifiability of the proposition "the points A and B are not separated by a turn of the spiral" from the figure. And we see that the proposition stating verifiability isn't a "proposition" in the same sense as the one whose verifiability is asserted. Here again, one can only say: look at the proof, and you will see *what* is proved here, what gets called "the proposition proved".

Page 301

Can one say that at each step of a proof we need a new insight? (The individuality of numbers.) Something of the following sort: if I am given a general (variable) rule, I must recognize each time afresh that this rule may be applied *here* too (that it holds for *this* case too). No act of foresight can absolve me from this act of *insight*. Since the form in which the rule is applied is in fact a new one at every step. But it is not a matter of an act of *insight*, but of an act of *decision*.

Page 301

What I called a proof of relevance does not climb the ladder to its proposition--since that *requires* that you pass every rung--but only shows that the ladder leads in the direction of that proposition.

Page Break 302

(There are no surrogates in logic). Neither is an arrow that points the direction a surrogate for going through all the stages towards a particular goal.

Page Break 303

Consistency proofs

Page 303

Something tells me that a contradiction in the axioms of a system can't really do any harm until it is revealed. We think of a hidden contradiction as like a hidden illness which does harm even though (and perhaps precisely because) it doesn't show itself in an obvious way. But two rules in a game which in a particular instance contradict each other are perfectly in order until the case turns up, and it's only then that it becomes necessary to make a decision between them by a further rule.

Page 303

Mathematicians nowadays make so much fuss about proofs of the consistency of axioms. I have the feeling that if there were a contradiction in the axioms of a system it wouldn't be such a great misfortune. Nothing easier than to remove it.

Page 303

"We may not use a system of axioms before its consistency has been proved."

Page 303

"In the rules of the game no contradictions may occur."

Page 303

Why not? "Because then one wouldn't know how to play."

Page 303

But how does it happen that our reaction to a contradiction is a doubt?

Page 303

We don't have any reaction to a contradiction. We can only say: if it's really meant like that (if the contradiction is *supposed* to be there) I don't understand it. Or: it isn't something I've learnt. I don't understand the sign. I haven't learnt what I am to do with it, whether it is a command, etc.

Page 303

Suppose someone wanted to add to the usual axioms of arithmetic the equation $2 \times 2 = 5$. Of course that would mean that the sign of equality had changed its meaning, i.e. that there would now be different rules for the equals-sign.

Page Break 304

Page 304

If I inferred "I cannot use it as a substitution sign" that would mean that its grammar no longer fitted the grammar of the word "substitute" ("substitution sign", etc.). For the word "can" in that proposition doesn't indicate a physical (physiological, psychological) possibility.

Page 304

"The rules may not contradict each other" is like "negation, when doubled, may not yield a negation". That is, it is part of the grammar of the word "rule" that if "p" is a rule, "p.~p" is not a rule.

Page 304

That means we could also say: the rules may contradict each other, if the rules for the use of the word "rule" are different--if the word "rule" has a different meaning.

Page 304

Here too we cannot give any foundation (except a biological or historical one or something of the kind); all we can do is to establish the agreement, or disagreement between the rules for certain words, and say that these words are used with these rules.

Page 304

It cannot be shown, proved, that these rules *can* be used as the rules of this activity.

Page 304

Except by showing that the grammar of the description of the activity fits the rules.

Page 304

"In the rules there *mustn't* be a contradiction" looks like an instruction: "In a clock the hand *mustn't* be loose on the shaft." We expect a reason: because otherwise... But in the first case the reason would have to be: because otherwise it wouldn't be a set of rules. Once again we have a grammatical structure that cannot be given a logical foundation.

Page 304

In the indirect proof that a straight line can have only *one* continuation through a certain point we make the supposition that a straight line could have two continuations.--If we make that

Page Break 305

supposition, then the supposition must make sense.--But what does it mean to make that supposition? It isn't making a supposition that goes against natural history, like the supposition that a lion has two tails.--It isn't making a supposition that goes against an ascertained fact. What it means is supposing a rule; and there's nothing against that except that it contradicts another rule, and for that reason I drop it.

Page 305

Suppose that in the proof there occurs the following drawing  to represent a straight line bifurcating. There is nothing absurd (contradictory) in that unless we have made some stipulation that it contradicts.

Page 305

If a contradiction is found later on, that means that hitherto the rules have not been clear and unambiguous. So the contradiction doesn't matter, because we can now get rid of it by enunciating a rule.

Page 305

In a system with a clearly set out grammar there are no hidden contradictions, because such a system must include the rule which makes the contradiction is discernible. A contradiction can only be hidden in the sense that it is in the higgledy-piggledy zone of the rules, in the unorganized part of the grammar; and there it doesn't matter since it can be removed by organizing the grammar.

Page 305

Why may not the rules contradict one another? Because otherwise they wouldn't be rules.

Page Break 306

15

Justifying arithmetic and preparing it for its applications
(Russell, Ramsey)

Page 306

One always has an aversion to giving arithmetic a foundation by saying something about its application. It appears firmly enough grounded in itself. And that of course derives from the fact that arithmetic is its own application.

Page 306

You could say: why bother to limit the application of arithmetic, that takes care of itself. (I can make a knife without bothering about what kinds of materials I will have cut with it; that will show soon enough.)

Page 306

What speaks against our demarcating a region of application is the feeling that we can understand arithmetic without having any such region in mind. Or put it like this: our instinct rebels against anything that isn't restricted to an analysis of the thoughts already before us.

Page 306

You could say arithmetic is a kind of geometry; i.e. what in geometry are constructions on paper in arithmetic are calculations (on paper). You could say, it is a more general kind of geometry.

Page 306

It is always a question of whether and how far it's possible to represent the most general form of the application of arithmetic. And here the strange thing is that in a certain sense it doesn't seem to be needed. And if in fact it isn't needed, then it's also impossible.

Page 306

The general form of its application seems to be represented by the fact that nothing is said about it. (And if that's a possible representation, then it is also *the* right one.)

Page 306

The point of the remark that arithmetic is a kind of geometry is simply that arithmetical constructions are autonomous like

geometrical ones and hence so to speak themselves guarantee their applicability.

For it must be possible to say of geometry too that it is its own application.

(In the sense in which we can speak of lines which are possible and lines which are actually drawn we can also speak of possible and actually represented numbers.)

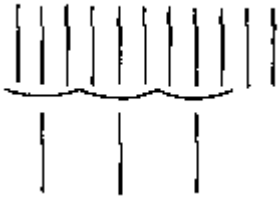

That is an arithmetical construction, and in a *somewhat* extended sense also a geometrical one.

Suppose I wish to use this calculation to solve the following problem: if I have 11 apples and want to share them among some people in such a way that each is given 3 apples how many people can there be? The calculation supplies me with the answer 3. Now suppose I were to go through the whole process of sharing and at the end 4 people each had 3 apples in their hands. Would I then say that the computation gave a wrong result? Of course not. And that of course means only that the computation was not an experiment.

It might look as though the mathematical computation entitled us to make a prediction, say, that I could give three people their share and there will be two apples left over. But that isn't so. What justifies us in making this prediction is an hypothesis of physics, which lies outside the calculation. The calculation is only a study of logical forms, of structures, and of itself can't yield anything new.

If 3 strokes on the paper are the sign for the number 3, then you can say the number 3 is to be applied in our language in the way in which the 3 strokes can be applied.

I said "One difficulty in the Fregean theory is the generality of the words 'Concept' and 'Object'. For, even if you can count

tables, tones, vibrations and thoughts, it is difficult to bracket them all together."†1 But what does "you *can* count them" mean? What it means is that it *makes sense* to apply the cardinal numbers to them. But if we know that, if we know *these* grammatical rules, why do we need to rack our brains about the other grammatical rules when we are only concerned to justify the application of cardinal arithmetic? It isn't difficult "to bracket them all together"; so far as is necessary for the present purpose they are already bracketed together.

But (as we all know well) arithmetic isn't at all concerned about this application. Its applicability takes care of itself.

Hence so far as the foundations of arithmetic are concerned all the anxious searching for distinctions between subject-predicate forms, and constructing functions 'in extension' (Ramsey) is a waste of time.

The equation 4 apples + 4 apples = 8 apples is a substitution rule which I use if instead of substituting the sign "8" for the sign "4 + 4", I substitute the sign "8 apples" for the sign "4 + 4 apples."

But we must beware of thinking that "4 apples + 4 apples = 8 apples" is the concrete equation and $4 + 4 = 8$ the abstract proposition of which the former is only a special case, so that the arithmetic of apples, though much less general than the truly general arithmetic, is valid in its own restricted domain (for apples). There isn't any "arithmetic of apples", because the equation 4 apples + 4 apples = 8 apples is not a proposition about apples. We may say that in this equation the word "apples" has no reference. (And we can always say this about a sign in a rule which helps to determine its meaning.)

How can we make preparations for the reception of something that may happen to exist--in the sense in which Russell and Ramsey always wanted to do this? We get logic ready for the existence of many-placed relations, or for the existence of an infinite number of objects, or the like.

Well, we can make preparations for the existence of a thing: e.g. I may make a casket for jewellery which may be made some time or other--But in this case I can say what the situation must be--what the situation is--for which I am preparing. It is no more difficult to describe the situation now than after it has already occurred; even, if it never occurs at all. (Solution of mathematical problems). But what Russell and Ramsey are making preparations for is a possible grammar.

On the one hand we think that the nature of the functions and of the arguments that are counted in mathematics is part of its business. But we don't want to let ourselves be tied down to the functions now known to us, and we don't know whether people will ever discover a function with 100 argument places; and so we have to make preparations and construct a function to get everything ready for a 100-place relation in case one turns up.--But what does "a 100-place relation turns up (or exists)" mean at all? What concept do we have of one? Or of a 2-place relation for that matter?--As an example of a 2-place relation we give something like the relation between father and son. But what is the significance of this example for the further logical treatment of 2-place relations? Instead of every "aRb" are we now to imagine "a is the father of b"?--If not, is this example or any example essential? Doesn't this example have the same role as an example in arithmetic, when I use 3 rows of 6 apples to explain $3 \times 6 = 18$ to somebody?

Here it is a matter of our concept of *application*.--We have an image of an engine which first runs idle, and then works a machine.

But what does the application add to the calculation? Does it

introduce a new calculus? In that case it isn't any longer *the same* calculation. Or does it give it substance in some sense which is essential to mathematics (logic)? If so, how can we abstract from the application at all, even only temporarily?

No, calculation with apples is essentially the same as calculation with lines or numbers. A machine is an extension of an engine, an application is not in the same sense an extension of a calculation.

Suppose that, in order to give an example, I say "love is a 2-place relation"--am I saying anything about love? Of course not. I am giving a rule for the use of the word "love" and I mean perhaps that we use *this* word in such and such a way.

Yet we do have the feeling that when we allude to the 2-place relation 'love' we put meaning into the husk of the calculus of relations.--Imagine a geometrical demonstration carried out using the cylinder of a lamp instead of a drawing or analytical symbols. How far is this an application of geometry? Does the use of the glass cylinder in the lamp enter into the geometrical thought? And does the use of word "love" in a declaration of love enter into my discussions of 2-place relations?

We are concerned with different uses or meanings of the word "application". "Division is an application of multiplication"; "the lamp is an application of the glass cylinder"; "the calculation is applied to these apples".

At this point we can say: arithmetic is its own application. The calculus is its own application.

In arithmetic we cannot make preparations for a grammatical application. For if arithmetic is only a game, its application too is only a game, and either the same game (in which case it takes us no further) or a different game--and in that case we could play it in pure arithmetic also.

So if the logician says that he has made preparations in arithmetic for the possible existence of 6-place relations, we may ask him: when what you have prepared finds its application, what will be added to it? A new calculus?--but that's something you haven't provided. Or something which doesn't affect the calculus?--then it doesn't interest us, and the calculus you have shown us is application enough.

Page 311

What is incorrect is the idea that the application of a calculus in the grammar of real language correlates it to a reality or gives it a reality that it did not have before.

Page 311

Here as so often in this area the mistake lies not in believing something false, but in looking in the direction of a misleading analogy.

Page 311

So what happens when the 6-place relation is found? Is it like the discovery of a metal that has the desired (and previously described) properties (the right specific weight, strength, etc.)? No; what is discovered is a word that we in fact use in our language as we used, say, the letter R. "Yes, but this word has meaning, and 'R' has none. So now we see that something can correspond to 'R'." But the meaning of the word does not consist in something's corresponding to it, except in a case like that of a name and what it names; but in our case the bearer of the name is merely an extension of the calculus, of the language. And it is *not* like saying "this story really happened, it was not pure fiction".

Page 311

This is all connected with the false concept of logical analysis that Russell, Ramsey and I used to have, according to which we are writing for an ultimate logical analysis of facts, like a chemical analysis of compounds--an analysis which will enable us really

Page Break 312

to discover a 7-place relation, like an element that really has the specific weight 7.

Page 312

Grammar is for us a pure calculus (not the application of a calculus to reality).

Page 312

"How can we make preparations for something which may or may not exist?" means: how can we hope to make an *a priori* construction to cope with all possible results while basing arithmetic upon a logic in which we are still waiting for the results of an analysis of our propositions in particular cases?--One wants to say: "we don't know whether it may not turn out that there are no functions with 4 argument places, or that there are only 100 arguments that can significantly be inserted into functions of *one* variable. Suppose, for example (the supposition does appear possible) that there is only one four-place function F and 4 arguments a, b, c, d; does it make sense in that case to say ' $2 + 2 = 4$ ' since there aren't any functions to accomplish the division into 2 and 2?" So now, one says to oneself, we will make provision for all possible cases. But of course that has no meaning. On the one hand the calculus doesn't make provision for possible existence; it constructs for itself all the existence that it needs. On the other hand what look like hypothetical assumptions about the logical elements (the logical structure) of the world are merely specifications of elements in a calculus; and of course you can make these in such a way that the calculus does not contain any $2 + 2$.

Page 312

Suppose we make preparations for the existence of 100 objects by introducing 100 names and a calculus to go with them. Then let us suppose 100 objects are really discovered. What happens now that the names have objects correlated with them which weren't correlated with them before? Does the calculus change?--What has the correlation got to do with it at all? Does it make it acquire more reality? Or did the calculus previously belong only to mathematics, and now to logic as well?--What sort of questions are "are there 3-place relations", "are there 1000 objects"? How is

Page Break 313

it to be decided?--But surely it is a fact that we can specify a 2-place relation, say love, and a 3-place one, say jealousy, but perhaps not a 27-place one!--But what does "to specify a 2-place relation" mean? It sounds as if we could point to a thing and say "you see, that is the kind of thing" (the kind of thing we described earlier). But nothing of that kind takes place (the comparison with pointing is altogether wrong). "The relation of jealousy cannot be reduced to 2-place relationships" sounds like "alcohol cannot be decomposed into water plus a solid substance". Is that something that is part of the nature of jealousy? (Let's not forget: the proposition "A is jealous of B because of C" is no more and no less reducible than the proposition "A is not jealous of B because of C".) What is pointed to is, say, the group of people A, B and C.--"But suppose that living beings at first knew only plane surfaces, but none the

less developed a 3-dimensional geometry, and that they suddenly became acquainted with 3-dimensional space!" Would this alter their geometry, would it become richer in content?--"Isn't this the way it is? Suppose at some time I had made arbitrary rules for myself prohibiting me from moving in my room in certain directions where there were no physical hindrances to get in my way; and then suppose the physical conditions changed, say furniture was put in the room, in such a way as to force me to move in accordance with the rules which I had originally imposed on myself arbitrarily. Thus, while the 3-dimensional calculus was only a game, there weren't yet three dimensions in reality because the x, y, z belonged to the rules only because I had so decided; but now that we have linked them up to the real 3 dimensions, no other movements are *possible* for them." But that is pure fiction. There isn't any question here of a connection with reality which keeps grammar on the rails. The "connection of language with reality", by means of ostensive definitions and the like, doesn't make the grammar inevitable or provide a justification for the grammar. The grammar remains a free-floating calculus which can only be extended and never supported. The "connection with

Page Break 314

reality" merely extends language, it doesn't force anything on it. We speak of discovering a 27-place relation but on the one hand no discovery can force me to use the sign or the calculus for a 27-place relation, and on the other hand I can describe the operation of the calculus itself simply by using this notation.

Page 314

When it looks in logic as if we are discussing several different universes (as with Ramsey), in reality we are considering different games. The definition of a "universe" in a case like Ramsey's would simply be a definition like

$$(\exists x).\phi x \stackrel{\text{Def}}{=} \phi a \vee \phi b \vee \phi c \vee \phi d.$$

Page Break 315

16

Ramsey's theory of identity

Page 315

Ramsey's theory of identity makes the mistake that would be made by someone who said that you could use a painting as a mirror as well, even if only for a single posture. If we say this we overlook that what is essential to a mirror is precisely that you can infer from it the posture of a body in front of it, whereas in the case of the painting you have to know that the postures tally before you can construe the picture as a mirror image.

Page 315

If Dirichlet's conception of function has a strict sense, it must be expressed in a *definition* that uses the table to define the function-signs as equivalent.

Page 315

Ramsey defines $\dagger 1$ $x = y$ as

$$(\phi_e) \bullet \phi_e x \exists \phi_e y$$

Page 315

But according to the explanations he gives of his function-sign " ϕ_e "

$(\phi_e) \bullet \phi_e x \exists \phi_e x$ is the statement: "every sentence is equivalent to itself."

$(\phi_e) \bullet \phi_e x \exists \phi_e y$ is the statement: "every sentence is equivalent to every sentence."

So all he has achieved by his definition is what is laid down by the two definitions

$$x = x. \stackrel{\text{Def}}{=} \text{Tautology}$$

$$x = y. \stackrel{\text{Def}}{=} \text{Contradiction}$$

(Here the word "tautology" can be replaced by any arbitrary tautology, and similarly with "contradiction"). So far all that has happened is that definitions have been given of the two distinct signs $x = x$ and $x = y$. These definitions could of course be replaced by two sets of definitions, e.g.

$$\left. \begin{array}{l} a = a \\ b = b \\ c = c \end{array} \right\} = \text{Taut.}$$

$$\left. \begin{array}{l} a = b \\ b = c \\ c = a \end{array} \right\} = \text{Contr.}$$

But then Ramsey writes:

" $(\exists x, y). x \neq y$ ", i.e. " $(\exists x, y). \sim(x = y)$ "--

but he has no right to: for what does the " $x = y$ " mean in this expression? It is neither the sign " $x = y$ " used in the definition above, nor of course the " $x = x$ " in the preceding definition. So it is a sign that is still unexplained. Moreover to see the futility of these definitions, you should read them (as an unbiased person would) as follows: I permit the sign "Taut", whose use we know, to be replaced by the sign " $a = a$ " or " $b = b$ ", etc.; and the sign "Contr." (" \sim Taut.") to be replaced by the sign " $a = b$ " or " $a = c$ ", etc. From which, incidentally, it follows that $(a = b) = (c = d) = (a \neq a) =$ etc.!

It goes without saying that an identity sign defined like that has no resemblance to the one we use to express a substitution rule.

Of course I can go on to define " $(\exists x, y). x \neq y$ ", say as $a \neq a. \vee. a \neq b. \vee. b \neq c. \vee. a \neq c$; but this definition is pure humbug and I should have written straightaway $(\exists x, y). x \neq y. \stackrel{\text{Def}}{=} \text{Taut}$. (That is, I would be given the sign on the left side as a new unnecessary--sign for "Taut.") For we mustn't forget that according to the definitions " $a = a$ ", " $a = b$ ", etc. are independent signs, no more connected with each other than the signs "Taut." and "Contr." themselves.

What is in question here is whether functions in extension are any use; because Ramsey's explanation of the identity sign is just such a specification by extension. Now what exactly is the specification of a function by its extension? Obviously, it is a group of definitions, e.g.

$fa = p$ Def.

$fb = q$ Def.

$fc = r$ Def.

These definitions permit us to substitute for the known propositions "p", "q", "r" the signs "fa" "fb" "fc". To say that these three definitions determine the function $f(\xi)$ is either to say nothing, or to say the same as the three definitions say.

For the signs "fa" "fb" "fc" are no more function and argument than the words "Co(m)", "Co(al)" and "Co(lt)" are. (Here it makes no difference whether or not the "arguments" "m", "al", "lt" are used elsewhere as words).

(So it is hard to see what purpose the definitions can have except to mislead us.)

To begin with, the sign " $(\exists x). fx$ " has no meaning; because here the rules for functions in the old sense of the word don't hold at all. According to them a definition like $fa = \dots$ would be nonsense. If no explicit definition is given for it, the sign " $(\exists x). fx$ " can only be understood as a rebus in which the signs have some kind of spurious meaning.

Each of the signs " $a = a$ ", " $a = c$ ", etc. in the definitions $(a = a). \stackrel{\text{Def}}{=} \text{Taut}$. etc. is a *word*.

Moreover, the purpose of the introduction of functions in extension was to analyse propositions about infinite extensions, and it fails of this purpose when a function in extension is introduced by a list of definitions.

There is a temptation to regard the form of an equation as the form of tautologies and contradictions, because it looks as if one can say that $x = x$ is self-evidently true and $x = y$ self-evidently false. The comparison between $x = x$ and a tautology is of course better than that between $x = y$ and a contradiction, because all correct (and "significant") equations of mathematics are actually of the form $x = y$. We might call $x = x$ a degenerate equation (Ramsey quite correctly called tautologies and contradictions degenerate propositions) and indeed a correct degenerate equation (the limiting case of an equation). For we use expressions of the form $x = x$ like correct

equations, and when we do so we are fully conscious that we are dealing with degenerate equations. In geometrical proofs there are propositions in the same case, such as "the angle α is equal to the angle β , the angle γ is equal to itself..."

Page 317

At this point the objection might be made that correct equations of the form $x = y$ must be tautologies, and incorrect ones contradictions, because it must be possible to prove a correct equation

Page Break 318

by transforming each side of it until an identity of the form $x = x$ is reached. But although the original equation is shown to be correct by this process, and to that extent the identity $x = x$ is the goal of the transformation, it is not its goal in the sense that the purpose of the transformation is to give the equation its correct form--like bending a crooked object straight; it is not that the equation at long last achieves its perfect form in the identity. So we can't say: a correct equation is *really* an identity. It just *isn't* an identity.

Page Break 319

17

The concept of the application of arithmetic†1 (mathematics)

Page 319

If we say "it must be essential to mathematics that it can be applied" we mean that its *applicability* isn't the kind of thing I mean of a piece of wood when I say "I will be able to find many applications for it".

Page 319

Geometry isn't the science (natural science) of geometric planes, lines and points, as opposed to some other science of gross physical lines, stripes and surfaces and *their* properties. The relation between geometry and propositions of practical life, about stripes, colour boundaries, edges and corners, etc. isn't that the things geometry speaks of, though *ideal* edges and corners, resemble those spoken of in practical propositions; it is the relation between those propositions and their grammar. Applied geometry is the grammar of statements about spatial objects. The relation between what is called a geometrical line and a boundary between two colours isn't like the relation between something fine and something coarse, but like the relation between possibility and actuality. (Think of the notion of possibility as a shadow of actuality.)

Page 319

You can describe a circular surface divided diametrically into 8 congruent parts, but it is senseless to give such a description of an elliptical surface. And that contains all that geometry says in this connexion about circular and elliptical surfaces.

Page 319

(A proposition based on a wrong calculation (such as "he cut a 3-metre board into 4 one metre parts") is nonsensical, and that throws light on what is meant by "making sense" and "meaning something by a proposition".)

Page Break 320

Page 320

What about the proposition "the sum of the angles of a triangle is 180 degrees"? At all events you can't tell by looking at it that it is a proposition of syntax.

Page 320

The proposition "corresponding angles are equal" means that if they don't appear equal when they are measured I will treat the measurement as incorrect; and "the sum of the angles of a triangle is 180 degrees" means that if it doesn't appear to be 180 degrees when they are measured I will assume there has been a mistake in the measurement. So the proposition is a postulate about the method of describing facts, and therefore a proposition of syntax.

Page Break 321

IV ON CARDINAL NUMBERS

18

Kinds of cardinal number

Page 321

What are numbers?--What numerals signify; an investigation of what they signify is an investigation of the grammar of numerals.

Page 321

What we are looking for is not a definition of the concept of number, but an exposition of the grammar of the word "number" and of the numerals.

Page 321

The reason why there are infinitely many cardinal numbers, is that *we* construct this infinite system and call it the system of cardinal numbers. There is also a number system "1, 2, 3, 4, 5, many" and even a system "1, 2, 3, 4, 5". Why shouldn't I call that too a system of cardinal numbers (a finite one)?

Page 321

It is clear that the axiom of infinity is not what Russell took it for; it is neither a proposition of logic, nor--as it stands--a proposition of physics. Perhaps the calculus to which it belongs, transplanted into quite different surroundings (with a quite different "interpretation"), might somewhere find a practical application; I do not know.

Page 321

One might say of logical concepts (e.g. of the, or a, concept of infinity) that their essence proves their existence.

Page 321

(Frege would still have said: "perhaps there are people who have not got beyond the first five in their acquaintance with the series of cardinal numbers (and see the rest of the series only in an indeterminate form or something of the kind), but this series exists independently of us". Does chess exist independently of us, or not?--)

Page 321

Here is a very interesting question about the position of the concept of number in logic: what happens to the concept of

Page Break 322

number if a society has no numerals, but for counting, calculating, etc. uses *exclusively* an abacus like a Russian abacus?

Page 322

(Nothing would be more interesting than to investigate the arithmetic of such people; it would make one really understand that here there is no distinction between 20 and 21.)

Page 322

Could we also imagine, in contrast with the cardinal numbers, a kind of number consisting of a series like the cardinal numbers without the 5? Certainly; but this kind of number couldn't be used for *any* of the things for which we use the cardinal numbers. The way in which these numbers are missing a five is not like the way in which an apple may have been taken out of a box of apples and can be put back again; it is of their essence to lack a 5; they do not *know* the 5 (in the way that the cardinal numbers do not know the number $\frac{1}{2}$). So these numbers (if you want to call them that) would be used in cases where the cardinal numbers (with the 5) couldn't meaningfully be used.

Page 322

(Doesn't the nonsensicality of the talk of the "basic intuition" show itself here?)

Page 322

When the intuitionists speak of the "basic intuition"--is this a psychological process? If so, how does it come into mathematics? Isn't what they mean only a primitive sign (in Frege's sense); an element of a calculus?

Page 322

Strange as it sounds, it is possible to know the prime numbers--let's say--only up to 7 and thus to have a finite system of prime numbers. And what we call the discovery that there are infinitely many primes is in truth the discovery of a new system with no greater rights than the other.

Page 322

If you close your eyes and see countless glimmering spots of light coming and going, as we might say, it doesn't make sense to speak of a 'number' of simultaneously seen dots. And you can't say "there is always a definite number of spots of light there, we

Page Break 323

just don't know what it is"; that would correspond to a rule applied in a case where you can speak of checking the number.

Page 323

(It makes sense to say: I divide many among many. But the proposition "I couldn't divide the many nuts among the many people" can't mean that it was logically impossible. Also you can't say "in some cases it is possible to divide many among many and in others not"; for in that case I ask: in *which* cases is this possible and in which impossible? And to that no further answer can be given in the many-system.)

Page 323

To say of a part of my visual field that it has no colour is nonsense; and of course it is equally nonsense to say that it has colour (or a colour). On the other hand it makes sense to say it has only *one* colour (is monochrome, or *uniform* in colour) or that it has at least two colours, only two colours, etc.

Page 323

So in the sentence "this square in my visual field has at least two colours" I cannot substitute "one" for "two". Or again: "the square has only one colour" does not mean--on the analogy of $(\exists x).\phi x.\sim(\exists x, y).\phi x.\phi y$ --"the square has one colour but not two colours".

Page 323

I am speaking here of the case in which it is senseless to say "that part of space has no colour". If I am counting the uniformly coloured (monochrome) patches in the square, it does incidentally make sense to say that there aren't any there at all, if the colour of the square is continually changing. In that case of course it also makes sense to say that there are one or more uniformly coloured patches in the square and also that the square has one colour and not two.--But for the moment I am disregarding that use of the sentence "the square has no colour" and am speaking of a system in which it would be called a matter of course that an area of a surface had a colour, a system, therefore, in which strictly speaking there is no such proposition. If you call the proposition self-evident you really mean something that is expressed by a grammatical rule giving the form of propositions about visual space, for

Page Break 324

instance. If you now begin the series of statements giving the number of colours in the square with the proposition "there is one colour in the square", then of course that mustn't be the proposition of grammar about the "colouredness" of space.

Page 324

What do you mean if you say "space is coloured"? (And, a very interesting question: what kind of question is this?) Well, perhaps you look around for confirmation and look at the different colours around you and feel the inclination to say: "wherever I look there is a colour", or "it's all coloured, all as it were painted." Here you are imagining colours in contrast to a kind of colourlessness, which on closer inspection turns into a colour itself. Incidentally, when you look around for confirmation you look first and foremost at static and monochromatic parts of space, rather than at unstable unclearly coloured parts (flowing water, shadows, etc.) If you then have to admit that you call just everything that you see colour, what you want to say is that being coloured is a property of space in itself, not of the parts of space. But that comes to the same as saying of chess that it is chess; and at best it can't amount to more than a description of the game. So what we must do is describe spatial propositions; but we can't justify them, as if we had to bring them into agreement with an independent reality.

Page 324

In order to confirm the proposition "the visual field is coloured" one looks round and says "that there is black, and black is a colour; that is white, and white is a colour", etc. And one regards "black is a colour" as like "iron is a metal" (or perhaps better, "gypsum is a sulphur compound").

Page 324

If I make it senseless to say that a part of the visual field has a colour, then asking for the analysis of a statement assigning the number of colours in a part of the visual space becomes very like asking for the analysis of a statement of the number of parts of a rectangle that I divide up into parts by lines.

Page 324

Here too I can regard it as senseless to say that the rectangle "consists of no parts". Hence, one cannot say that it consists of one or more parts, or that it has at least *one* part. Imagine the special case of a rectangle divided by parallel lines. It doesn't matter that this is a very special case, since we don't regard a game as less remarkable just because it has only a very limited application.

Page Break 325

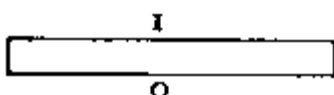
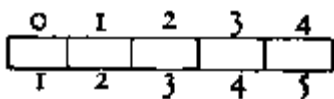

Here I can if I want count the parts in the usual manner, and then it is meaningless to say there are 0 parts. But I could also imagine a way of counting which so to say regards the first part as a matter of course and doesn't count it or counts it as 0, and counts only the parts which are added to this by division. Again, one could imagine a custom according to which, say, soldiers in rank and file were always counted by giving the number of soldiers in a line over and above the first soldier (perhaps because we wanted the number of possible combinations of the fugleman with another soldier of the rank.). But a custom might also exist of always giving the number of soldiers as 1 greater than the real one. Perhaps this happened originally in order to deceive a particular officer about the real number, and later came into general use as a way of counting soldiers. (The academic quarter).†1 The number of different colours on a surface might also be given by the number of their possible combinations in pairs and in that case the only numbers that would count would be numbers of the form $n/2(n - 1)$; it would be as senseless then to talk of the 2 or 4 colours of a surface as it now is to talk of the $\sqrt{2}$ or i colours. I want to say that it is not the case that the cardinal numbers are essentially primary and what we might call the combination numbers--1, 2, 6, 10 etc.--are secondary. We might construct an arithmetic of the combination numbers and it would be as self-contained as the arithmetic of the cardinal numbers. But equally of course there might be an arithmetic of the even numbers or of the numbers 1, 3, 4, 5, 6, 7... Of course the decimal system is ill-adapted for the writing of these kinds of number.

Page 325

Imagine a calculating machine that calculates not with beads but with colours on a strip of paper. Just as we now use our fingers, or the beads on an abacus, to count the colours on a strip

Page Break 326

so then we would use the colours on a strip to count the beads on a bar or the fingers on our hand. But how would this colour-calculating machine have to be made in order to work? We would need a sign for there being no bead on the bar. We must imagine the abacus as a practical tool and as an instrument in language. Just as we can now represent a number like 5 by the five fingers of a hand (imagine a gesture language) so we would then represent it by a strip with five colours. But I need a sign for the 0, otherwise I do not have the necessary multiplicity. Well, I can either stipulate that a black surface is to denote the 0 (this is of course arbitrary and a monochromatic red surface would do just as well): or that any one-coloured surface is to denote zero, a two-coloured surface 1, etc. It is immaterial which method of denotation I choose. Here we see how the multiplicity of the beads is projected onto the multiplicity of the colours on a surface.

Page 326

It makes no sense to speak of a black two-sided figure in a white circle; this is analogous to its being senseless to say that the rectangle consists of 0 parts (no part). Here we have something like a lower limit of counting before we reach the number one.

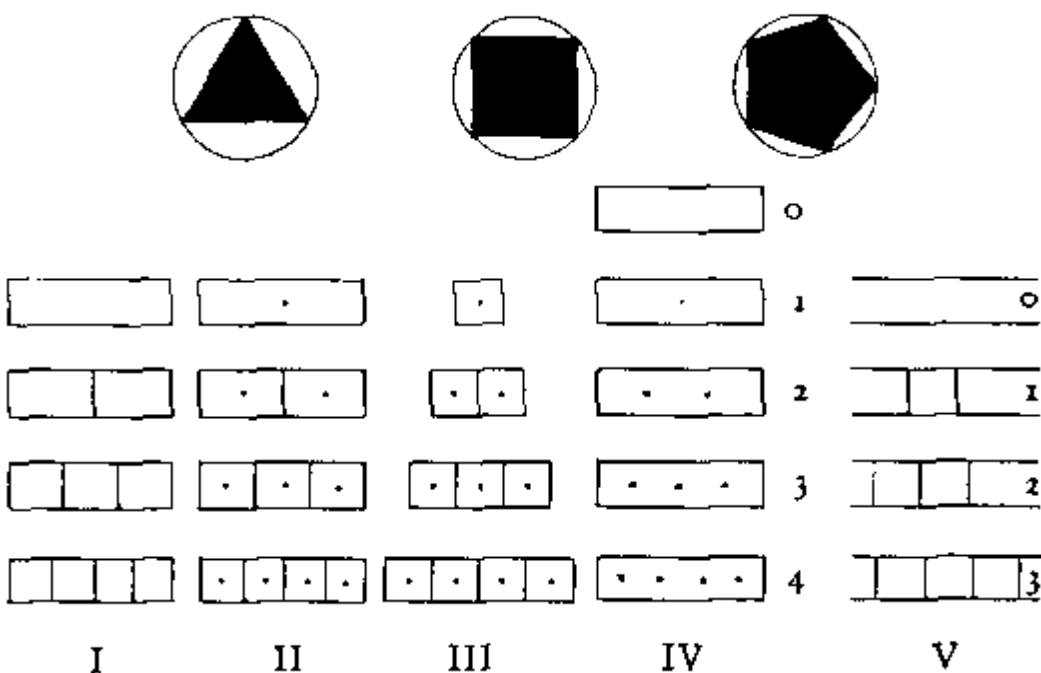

Page Break 327

Is counting parts in I the same as counting points in IV? What makes the difference? We may regard counting the parts in I as counting rectangles; but in that case one can also say: "in this row there is *no* rectangle"; and then one isn't counting *parts*. We are disturbed both by the analogy between counting the points and counting the parts, and by the breakdown of the analogy.

There is something odd in counting the undivided surface as "one"; on the other hand we find no difficulty in seeing the surface after a single division as a picture of 2. Here we would much prefer to count "0, 2, 3", etc. And this corresponds to the series of propositions "the rectangle is undivided", "the rectangle is divided into 2 parts", etc.

If it's a question of different colours, you can imagine a way of thinking in which you don't say that here we have two colours, but that here we have a distinction between colours; a style of thought which does not see 3 at all in red, green and yellow; which does indeed recognise as a series a series like: red; blue, green; yellow, black, white; etc., but doesn't connect it with the series |; ||; |||; etc., or not in such a way as to correlate | with the term red.

From the point of view from which it is 'odd' to count the undivided surface as one, it is also natural to count the singly divided one as two. That is what one does if one regards it as two rectangles, and that would mean looking at it from the standpoint from which the undivided one might well be counted as one rectangle. But if one regards the first rectangle in I as the undivided surface, then the second appears as a whole with one division (one distinction) and division here does not necessarily mean dividing line. What I am paying attention to is the distinctions, and here there is a series of an increasing number of distinctions. In that case I will count the rectangles in I "0, 1, 2, etc."

This is all right where the colours on a strip border on each other, as in the schema



But it is different if the arrangement is

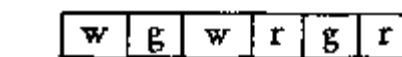

. Of course

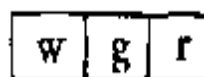

I might also correlate each of these two schemata with the schema

and correlate schemata like

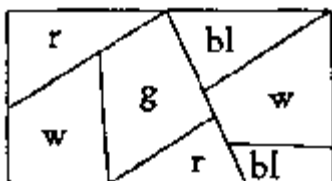

with the schema

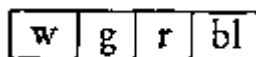

, etc. And that way of thinking though

certainly unnatural is perfectly correct.

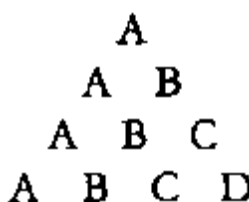

The most natural thing is to conceive the series of schemata as etc. And here we may denote the first schema by '0', the second by '1', but the third say with '3', if we think of all possible distinctions, and the fourth by '6' Or we may call the third schema '2' (if we are concerned simply with an arrangement) and the fourth '3'.

We can describe the way a rectangle is divided by saying: it is divided into five parts, or: 4 parts have been

It is the same if I am counting the lengths of sticks or the size of hats.

If I counted with strokes, I might write them thus $|, \vee, \nabla, \swarrow$, in order to show that what matters is the *distinction* between the directions and that a simple stroke corresponds to 0 (i.e. is the beginning).

Here incidentally there is a certain difficulty about the numerals (1), ((1) + 1), etc.: beyond a certain length we cannot distinguish them any further without counting the strokes, and so without translating the signs into different ones. "||||||" and "||||||" cannot be distinguished in the same sense as 10 and 11, and so they aren't in the same sense distinct signs. The same thing could also happen incidentally in the decimal system (think of the numbers 111111111 and 1111111111), and that is not without significance.

Imagine someone giving us a sum to do in a stroke-notation, say ||||| + |||||, and, while we are calculating, amusing himself by removing and adding strokes without our noticing. He would keep on saying: "but the sum isn't right", and we would keep going through it again, fooled every time.--Indeed, strictly speaking, we wouldn't have any concept of a criterion for the correctness of the calculation.

Here one might raise questions like: is it only *very probable* that $464 + 272 = 736$? And in that case isn't $2 + 3 = 5$ also only very probable? And where is the objective truth which this probability approaches? That is, how do we get a concept of $2 + 3$'s really *being* a certain number, apart from what it *seems* to us to be?

For if it were asked: what is the criterion in the stroke-notation for our having the same numeral in front of us twice?--the answer might be: "if it looks the same both times" or "if it contains the same number of lines both times". Or should it be: if a one-one correlation etc. is possible?

How can I know that ||||| and ||||| are the *same* sign? After all it is not enough that they look *alike*. For having roughly the same gestalt can't be what is to constitute the identity of the signs, but just their being the same in number.

(The problem of the distinction between $1 + 1 + 1 + 1 + 1 + 1 + 1$ and $1 + 1 + 1 + 1 + 1 + 1 + 1$ is much more fundamental than appears at first sight. It is a matter of the distinction between physical and visual number.)

$$19$$

$$2 + 2 = 4$$

A cardinal number is an internal property of a list. Are numbers essentially concerned with concepts? I believe this amounts to asking whether it makes sense to ascribe a number to objects that haven't been brought under a concept. Does it, for example, make sense to say "a, b and c are three objects"?--Admittedly we have a feeling: why talk about concepts, the number of course depends only on the *extension* of the concept, and once that has been determined the concept may drop out of the picture. The concept is only a method for determining an extension, but the extension is autonomous and, in its essence, independent of the concept; for it's quite immaterial which concept we have used to determine the extension. That is the argument for the extensional viewpoint. The immediate objection to it is: if a concept is really only an expedient for aiming at an extension, then there is no place for concepts in arithmetic; in that case we must simply divorce a class completely from the concept which happens to be associated with it. But if it isn't like that, then an extension independent of the concept is just a chimaera, and in that case it's better not to speak of it at all, but only of the concept.

The sign for the extension of a concept is a list. We might say, as an approximation, that a number is an external property of a concept and an internal property of its extension (the list of objects that fall under it). A number is a schema for the extension of a concept. That is, as Frege said, a statement of number is a statement about a concept (a predicate). It's not about the extension of a concept, i.e. a list that may be something like the extension of a concept. But a number-statement about a concept has a similarity to a proposition saying that a determinate list is the extension of the concept. I use such a list when I say "a, b, c, d, fall under the concept $F(x)$ ": "a, b, c, d," is the list. Of course this proposition

says the same as Fa.Fb.Fc.Fd; but the use of the list in writing the proposition shows its relationship to " $(\exists x, y, z, u). Fx.Fy.Fz.Fu$ " which we can abbreviate as " $(\exists |||x).F(x)$."

What arithmetic is concerned with is the schema $|||$.--But does arithmetic talk about the lines that I draw with pencil on paper?--Arithmetic doesn't talk about the lines, it *operates* with them.

A statement of number doesn't always contain a generalization or indeterminacy: "The line AB is divided into 2 (3, 4, etc.) equal parts."

If you want to know what $2 + 2 = 4$ means, you have to ask how we work it out. That means that we consider the process of calculation as the essential thing; and that's how we look at the matter in ordinary life, at least as far as concerns the numbers that we have to work out. We mustn't feel ashamed of regarding numbers and sums in the same way as the everyday arithmetic of every trader. In everyday life we don't work out $2 + 2 = 4$ or any of the rules of the multiplication table; we take them for granted like axioms and *use them* to calculate. But of course we could work out $2 + 2 = 4$ and children in fact do so by counting off. Given the sequence of numbers 1 2 3 4 5 the

1 2 1 2

calculation is 1 2 3 4

Abbreviative Definitions:

$$\begin{aligned}
 (\exists x). \phi x : \sim (\exists x, y). \phi x. \phi y & \stackrel{\text{Def}}{=} .(\epsilon x). \phi x \\
 (\exists x, y). \phi x. \phi y : \sim (\exists x, y, z). \phi x. \phi y. \phi z & \stackrel{\text{Def}}{=} .(\epsilon x, y). \phi x. \phi y, \text{ etc.} \\
 (\epsilon x). \phi x & \stackrel{\text{Def}}{=} .(\epsilon |x). \phi x \\
 (\epsilon x, y). \phi x. \phi y & \stackrel{\text{Def}}{=} .(\epsilon ||x). \phi x. \stackrel{\text{Def}}{=} .(\epsilon 2x). \phi x, \text{ etc.}
 \end{aligned}$$

It can be shewn that

$$(\epsilon ||x). \phi x. (\epsilon |||x). (\psi x). \underbrace{\sim (\exists x). \phi x. \psi x}_{\text{Ind.}} \supset .(\epsilon ||||x). \phi x \vee \psi x$$

is a tautology.

Does that prove the arithmetical proposition $2 + 3 = 5$? Of course not. It does not even show that $(\epsilon ||x). \phi x. (\epsilon |||x). \psi x. \text{Ind.} \supset .(\epsilon || + |||x). \phi x \vee \psi x$ is tautologous, because nothing was said in our definitions about a sum $(|| + |||)$. (I will write the tautology in the abbreviated form " $\epsilon ||. \epsilon |||. \supset . \epsilon ||||$ ".) Suppose the question is, given a left hand side, to find what number of lines to the right of " \supset " makes the whole a tautology. We can find the number, we can indeed discover that in the case above it is $|| + |||$; but we can equally well discover that it is $| + ||||$ or $| + ||| + |$, for it is all of these. We can also find an inductive proof that the algebraic expression

$$\epsilon n. \epsilon m. \supset . \epsilon n + m$$

is tautologous. Then I have a right to regard a proposition like

$$\epsilon 17. \epsilon 28. \supset . \epsilon (17 + 28)$$

as a tautology. But does that give us the equation $17 + 28 = 45$? Certainly not. I still have to work it out. In accordance with this general rule, it also makes sense to write $\epsilon 2. \epsilon 3. \supset . \epsilon 5$ as a tautology if, as it were, I don't yet know what $2 + 3$ yields; for $2 + 3$ only has sense in so far as it has still to be worked out.

Hence the equation $|| + ||| = ||||$ only has a point if the sign "||||" can be recognised in the same way as the sign "5", that is, independently of the equation.

The difference between my point of view and that of contemporary writers on the foundations of arithmetic is that I am not obliged to despise particular calculi like the decimal system. For me one calculus is as good as another. To look down on a particular calculus is like wanting to play chess without real pieces, because playing with pieces is too particularized and not abstract enough. If the pieces really *don't* matter then one lot is just as good as

another. And if the games are really distinct from each other, then one game is as good, i.e. as interesting, as the other. None of them is more sublime than any other.

Page Break 335

Page 335

Which proof of $\varepsilon||$. $\varepsilon|||$. \supset . $\varepsilon||||$ expresses our knowledge that this is a correct logical proposition?

Page 335

Obviously, one that makes use of the fact that one can treat $(\exists x)...$ as a logical sum. We may translate from a symbolism like $\begin{array}{|c|c|} \hline * & * \\ \hline \end{array}$ ("if there is a star in each square, then there are two in the whole rectangle") into the Russellian one. And it isn't as if the tautologies in that notation expressed an idea that is confirmed by the proof after first of all appearing merely plausible; what appears plausible to us is that this expression is a tautology (a law of logic).

Page 335

The series of propositions

$$(\exists x): aRx.xRb$$

$$(\exists x, y): aRx.xRy.yRb$$

$$(\exists x, y, z): aRx.xRy.yRz.zRb, \text{ etc.}$$

may perfectly well be expressed as follows:

Page 335

"There is one term between a and b".

Page 335

"There are two terms between a and b", etc.,

and may be written in some such way as:

$$(\exists 1x).aRxRb, (\exists 2x).aRxRb, \text{ etc.}$$

Page 335

But it is clear that in order to understand this expression we need the explanation above, because otherwise by analogy with $(\exists 2x).\phi x. = .(\exists x, y).\phi x.\phi y$ you might believe that $(\exists 2x).aRxRb$ was equivalent to the expression $(\exists x, y).aRxRb.aRyRb$.

Page 335

Of course I might also write " $(\exists 2x, y).F(x, y)$ " instead of " $(\exists x, y).F(x, y)$ ". But then the question would be: what am I to take " $(\exists 3x, y).F(x, y)$ " as meaning? But here a rule can be given; and indeed we need one that takes us further in the number series as far as we want to go. E.g.:

$$(\exists 3x, y).F(x, y). = .(\exists x, y, z):F(x, y).F(x, z).F(y, z)$$

$$(\exists 4x, y).F(x, y). = .(\exists x, y, z, u):F(x, y).F(x, z)...$$

followed by the combinations of two elements, and so on. But we might also give the following definition:

$$(\exists 3x, y).F(x, y). = .(\exists x, y, z):F(x, y).F(y, x).F(x, z).$$

$$F(z, x).F(y, z).F(x, y), \text{ and so on.}$$

Page Break 336

Page 336

" $(\exists 3 x, y).F(x, y)$ " would perhaps correspond to the proposition in word-language "F(x, y) is satisfied by 3 things"; and that proposition too would need an explanation if it was not to be ambiguous.

Page 336

Am I now to say that in these different cases the sign "3" has different meanings? Isn't it rather that the sign "3" expresses what is common to the different interpretations? Why else would I have chosen it? Certainly, in each of these contexts, the same rules hold for the sign "3". It is replaceable by $2 + 1$ as usual and so on. But at all events a proposition on the pattern of $\varepsilon||$. $\varepsilon|||$. \supset . $\varepsilon||||$ is no longer a tautology. Two men who live at peace with each other and three other men who live at peace with each other do not make five men who live at peace with each other. But that does not mean that $2 + 3$ are no longer 5; it is just that addition cannot be applied in that way. For one might say: 2 men who... and 3 men who..., each of whom lives at peace with each of the first group, = 5 men who...

Page 336

In other words, the signs of the form $(\exists 1x, y).F(x, y)$, $(\exists 2x, y). F(x, y)$ etc. have the same multiplicity as the

cardinal numbers, like the signs $(\exists 1x).\phi x$, $(\exists 2x).\phi x$, etc. and also like the signs $(\epsilon 1x).\phi x$, $(\epsilon 2x).\phi x$, etc.

Page 336

"There are only 4 red things, but they don't consist of 2 and 2, as there is no function under which they fall in pairs". That would mean regarding the proposition $2 + 2 = 4$ thus: if you can see 4 circles on a surface, every two of them always have a particular property in common; say a sign inside the circle. (In that case of course every three of the circles too will have to have a sign in common etc.) If I am to make any assumption at all about reality, why not *that*? The 'axiom of reducibility' is essentially the same kind of thing. In this sense one might say that 2 and 2 do always make 4, but 4 doesn't always consist of 2 and 2. (It is only because of the utter vagueness and generality of the axiom of reducibility that we are seduced

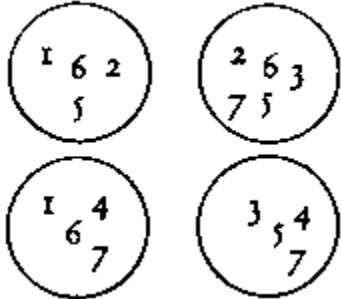

Page Break 337

into believing that--if it is a significant sentence at all--it is more than an arbitrary assumption for which there is no ground. For this reason, in this and all similar cases, it is very illuminating to drop this generality, which doesn't make the matter any more mathematical, and in its place to make very specific assumptions.)

Page 337

We feel like saying: 4 does not always have to consist of 2 and 2, but if it does consist of groups it can consist of 2 and 2, or of 3 and 1 etc.; but not of 2 and 1 or 3 and 2, etc. In that way we get everything prepared in case 4 is actually divisible into groups. But in that case arithmetic doesn't have anything to do with the actual division, but only with the possibility of division. The assertion might just as well be the assertion that any two of a group of 4 dots on paper are always joined by a line.

Page 337

Or that around every 2 such groups of 2 dots in the real world there is always a circle drawn.

Page 337

Add to this that a statement like "you can see two black circles in a white rectangle" doesn't have the form $(\exists x, y)$, etc.". For, if I give the circles names, the names refer to the precise location of the circles and I can't say of them that they are either in this rectangle or in the other. I can indeed say "there are 4 circles in both rectangles taken together" but that doesn't mean that I can say of each individual circle that it is in one rectangle or the other. For in the case supposed the sentence "this circle is in this rectangle" is senseless.

Page 337

But what does the proposition "there are 4 circles in the 2 rectangles taken *together*" mean? How do I establish that? By adding the numbers in each? In that case the number of the circles in the two rectangles *means* the result of the addition of the two numbers.--Or is it something like the result of taking a count through both rectangles? Or the number of lines I get if I correlate a line to a circle no matter whether it is in this rectangle *or* in the

Page Break 338

other? If "this circle" is individuated by its position, we can say "every line is correlated either to a circle in this rectangle or to a circle in the other rectangle" but not "this circle is either in this

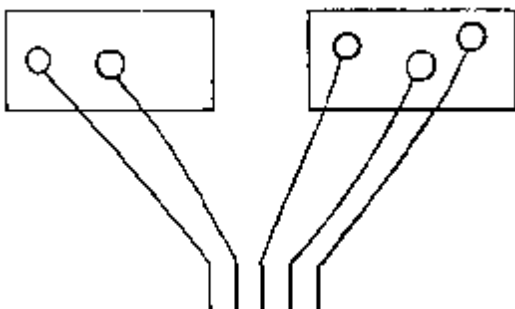

rectangle or in the other". *This* can only be *here* if "this" and "here" do not mean the same. By contrast *this* line can be correlated to a circle in this rectangle because it remains *this* line, even if it is correlated to a circle in the other

rectangle.

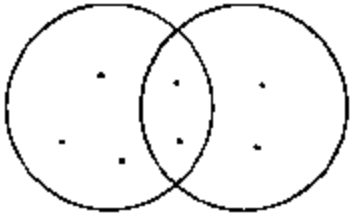

Page 338

In these two circles together are there 9 dots or 7? As one normally understands the question, 7. But must I understand it so? Why shouldn't I count twice the points that are common to both circles?

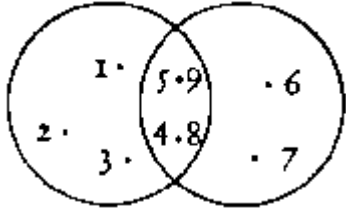

Page 338

It is a different matter if we ask "how many dots are within the black lines?" For here I can say: in the sense in which there are 5 and 4 in the circles, there are 7.

Page Break 339

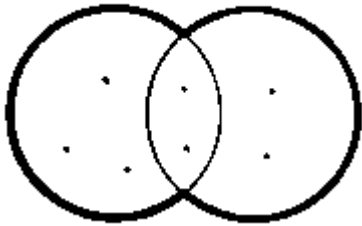

Page 339

Now we might say: by the sum of 4 and 5 I mean the number of the objects which fall under the concept $\phi x \vee \psi x$, if it is the case that $(\exists 4x) \uparrow 1. \phi x. (\exists 5x). \psi x$. Ind. That doesn't mean that the sum of 4 and 5 may only be used in the context of propositions like $(\exists 4x). \phi x$; it means: if you want to construct the sum of n and m , insert the numbers on the left hand side of " \supset " in the form $(\exists nx). \phi x. (\exists mx). \psi x$, etc., and the sum of m and n will be the number which has to go on the right hand side in order to make the whole proposition a tautology. So that is a method of addition--a very long-winded one.

Page 339

Compare: "Hydrogen and oxygen yield water", "2 dots and 3 dots yield 5 dots".

Page 339

So do e.g. 2 dots in my visual field, that I "see as 4" and not "as 2 and 2", consist of 2 and 2? Well, what does that mean? Is it asking whether in some way they are divided into groups of 2 dots each? Of course not (for in that case they would presumably have had to be divided in all other conceivable ways as well). Does it mean that they *can* be divided into groups of 2 and 2, i.e. that it *makes sense* to speak of such groups in the four?--At any rate it does correspond to the sentence $2 + 2 = 4$ that I can't say that the group of 4 dots I saw consisted of separate groups of 2 and 3. Everyone will say: that's impossible, *because* $3 + 2 = 5$. (And "impossible" here means "nonsensical".)

Page 339

"Do 4 dots consist of 2 and 2?" may be a question about a physical or visual fact; for it isn't the question in arithmetic. The

Page Break 340

arithmetical question, however, certainly could be put in the form: "Can a group of 4 dots consist of separate groups of 2?"

Page 340

"Suppose that I used to believe that there wasn't anything at all except one function and the 4 objects that satisfy it. Later I realise that it is satisfied by a fifth thing too: does this make the sign '4' become senseless?"--Well, if there is no 4 in the *calculus* then '4' is senseless.

Page 340

If you say it would be possible when adding to make use of the tautology $(\exists 2x).\phi x.(\exists 3x).\psi x.Ind. \supset.(\exists 5x).\phi x \vee \psi x...$ A) this is how it would have to be understood: first it is possible to establish according to certain rules that $(\exists x).\phi x.(\exists x).\psi x.Ind..\supset.(\exists x, y):\phi x \vee \psi x.\phi y \vee \psi y.$ is tautological. $(\exists x).\phi x$ is an abbreviation for $(\exists x).\phi x.\sim(\exists x, y).\phi x.\phi y.$ I will abbreviate further tautologies like A thus: $(E).(E).\supset.(E)$

Page 340

Therefore

$(\exists x).\phi x.(\exists x).\psi x.\supset.(\exists x, y).\phi x.\psi y.(\exists x, y).\phi x.\psi y.\supset.(\exists x, y, z).$

and other tautologies follow from the rules. I write "and other tautologies" and not "and so on ad inf." since one doesn't yet have to use that concept.

Page 340

†1 When the numbers were written out in the decimal system there were rules, namely the addition rules for every pair of numbers from 0 to 9, and, used appropriately, these sufficed for the addition of all numbers. Now which rule corresponds to these elementary

Page Break 341

rules? It is obvious that in a calculation like σ we don't have to keep as many rules in mind as in $17 + 28$. Indeed we need only *one* general rule. We don't need any rules like $3 + 2$; on the contrary, we now seem to be able to deduce, or work out, how many $3 + 2$ makes.

Page 341

We are given the sum $2 + 3 = ?$ and we write

1, 2, 3, 4, 5, 6, 7
1, 2; 1, 2, 3

Page 341

That is in fact how children calculate when they "count off". (And that calculus must be as good as any other.)

Page 341

It is clear incidentally that the problem whether $5 + (4 + 3) = (5 + 4) + 3$ can be solved in *this* way:

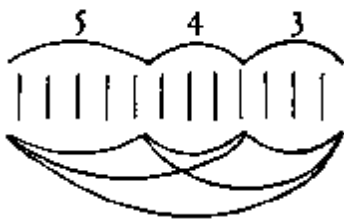

for this construction has precisely the same multiplicity as every other proof of that proposition.

A	B	C	D	E	F	G	H	I	J	K	L	MNO
A	B	C	D	E,	A	B	C	D				
A								I,	A	B	C	
A					A	B	C	D,	A	B	C	
A					A		G					
A				E,	A		G					
A							L					

Page 341

If I name each number after its last letter, that is a proof that $(E + D) + C = E + (D + C) = L$

Page 341

This is a good form of proof, because it shows clearly that the result is really worked out and because from it you can read off the general proof as well.

Page 341

It may sound odd, but it is good advice at this point: don't do philosophy here, do mathematics.

Page Break 342

Our calculus doesn't at all need to be acquainted with the construction of a series '(E x)', '(E x, y)', '(E x, y, z)' etc.; we can simply introduce two or three such signs without the "etc.". We can then introduce a calculus with a finite series of signs by laying down a sequence of certain signs, say the letters of the alphabet, and writing:

(E a).(E a). \supset .(E a, b)
 (E a, b).(E a). \supset .(E a, b, c)
 (E a, b).(E a, b). \supset .(E a, b, c, d)
 etc. up to z.

The right hand side (the side to the right of " \supset ") can then be found from the left hand side by a calculus like:

a b c d e f . . . z
 a b - - -
 - - a b c

B)

a b c d e

This calculus could be derived from the rules for the construction of tautologies as a simplification.--If I presuppose this law for constructing a fragment of the series out of two others, I can then introduce as a designation of that fragment the expression "sum of the two others", and thus give the definition:

a + a $\stackrel{\text{Def}}{=}$ ab
 a + ab $\stackrel{\text{Def}}{=}$ abc

and so on up to z.

If the rules for the calculus B had been explained by examples, we could regard those definitions too as particular cases of a general rule and then set problems like "abc + ab =?". It is now tempting to confuse the tautology

α) (E a, b). (E a, b). \supset . (E a, b, c, d)

with the equation

β) ab + ab = abcd

But the latter is a replacement rule, the former isn't a rule but just a tautology. The sign " \supset " in α in no way corresponds to the "=" in β .

We forget that the sign " \supset " in α doesn't say that the two signs to the left and right of it yield a tautology.

On the other hand we might construct a calculus in which the equation $\xi + \eta = \eta$ was obtained as a transformation of the equation

γ) (E ξ). (E η). \supset . (E ζ) = Taut.

So that I as it were get $\zeta = \xi + \eta$ if I work out ζ from the equation γ .

In these discussions, how does the concept of sum make its entry?--There is no mention of summation in the original calculus that lays down that the form

δ) (E ξ). (E η). \supset (E ζ)

is tautologous where $\xi = xy$, $y = x$ and $\zeta = xyz$.--Later we introduce into the calculus a number system (say the system a, b, c, d,... z), and finally we define the sum of two numbers as the number that solves the equation γ .

If we wrote "(E x).(E x). \supset .(E x, y)" instead of "(E x). (E x). \supset . (E x + x)" it would make no sense; unless the

notation already went, not

Page 343

ι) "(E x), etc.", "(E x, y) etc.", "(E x, y, z), etc."

but

Page 343

κ) "(E x), etc.", "(E x + x) etc.", "(E x + x + x), etc."

For why should we suddenly write

"(E x, y).(E x). ⊃.(E xy + x)" instead of "(E x, y).(E x). ⊃.(E x, y, z)"?

That would just confuse the notation.--Then we say: it will greatly simplify the writing of the tautologies if we can write in the right bracket simply the expressions in the two left brackets. But so far that notation hasn't been explained: I don't know what (E xy + x) means, or that (E xy + x) = (E x, y, z).

Page 343

But if the notation already went "(E x)", "(E x + x)", "(E x + x + x)" that would only give a sense to the expression "(E x + x + x + x + x)" and not to (E (x + x) + (x + x)).

Page 343

The notation κ is in the same case as ι. A quick way of calculating whether you get a tautology of the form δ is to draw connecting lines, thus

Page Break 344

$(E x, y) . (E x, y) . \supset . (E x, y, z, u)$

and analogously

$(E x + x) . (E x + x) . \supset . (E x \cdot x \cdot | x \cdot | x)$

Page 344

The connecting lines only correspond to the rule which we have to give in any case for checking the tautology. There is still no mention of addition; that doesn't come in until I decide--e.g.--to write "xy + yx" instead of "x, y, z, u" and adjoin a calculus with rules that allow the derivation of the replacement rule "xy + yx = xyzu".

Again, addition doesn't come in when I write in the notation κ "(E x).(E x). ⊃.(E x + x)"; it only comes in when I distinguish between "x + x" and "(x) + (x)" and write (x) + (x) = (x + x)

Page 344

I can define "the sum of ξ and η" "(ξ + η)" as the number (or "the expression" if we are afraid to use the word "number")--I can define "ξ + η" as the number ζ that makes the expression δ tautologous; but we can also define "ξ + η" (independently of the calculus of tautologies) by the calculus B and then *derive* the equation (E ξ).(E η). ⊃.(E ξ + η) = Taut.

Page 344

A question that suggests itself is this: must we introduce the cardinal numbers in connection with the notation (∃x, y,...).φx.φy...? Is the calculus of the cardinal numbers somehow bound up with the calculus of the signs "(∃x, y,...).φx.φy...? Is that kind of calculus perhaps in the nature of things the only application of the cardinal numbers? So far as concerns the "application of the cardinal numbers in the grammar", we can refer to what we said about the concept of the application of a calculus. We might put our question in this way too: in the propositions of our language--if we imagine them translated into Russell's notation--do the cardinal numbers always occur after the sign "∃"? This question

Page Break 345

is closely connected with another: Is a numeral always used in language as a characterization of a concept--a function? The answer to that is that our language does always use the numerals as attributes of concept-words--but that these concept-words belong to different grammatical systems that are so totally distinct from each other (as you see from the fact that some of them have meaning in contexts in which others are senseless), that a norm making them all concept-words is an uninteresting one. But the notation "(∃x, y...) etc." is just such a norm. It is a straight translation of a norm of our word-language, the expression "there is...", which is a form of expression into which countless grammatical forms are squeezed.

Moreover there is another sense of numeral in which numerals are not connected with " \exists ": that is, in so far as " $(\exists 3)_x \dots$ " is not contained in " $(\exists 2 + 3)_x \dots$ ".

If we disregard functions containing "=" ($x = a. \vee .x = b$, etc.), then on Russell's theory $5 = 1$ if there are no functions that are satisfied by only *one* argument, or by only 5 arguments. Of course at first this proposition seems nonsensical; for in that case how can one sensibly say that there are no such functions? Russell would have to say that the statement that there are five-functions and the statement that these are one-functions can only be separated if we have in our symbolism a five-class and a one-class. Perhaps he could say that his view is correct because without the paradigm of the class 5 in the symbolism, I can't say at all that a function is satisfied by five arguments. That is to say, from the existence of the sentence " $(\exists \phi: (\exists 1 x). \phi x$ " its truth already follows.--So you seem to be able to say: look at this sentence, and you will see that it is true. And in a sense irrelevant for our purposes that is indeed possible: think of the wall of a room on which is written in red "in this room there is something red".--

This problem is connected with the fact that in an ostensive definition I do not state anything about the paradigm (sample); I only use it to make a statement. It belongs to the symbolism and is not one of the objects to which I apply the symbolism.

For instance, suppose that "1 foot" were defined as the length of a particular rod in my room, so that instead of saying "this door is 6 ft high" I would say "this door is six times as high as *this* length" (pointing to the unit rod). In that case we couldn't say things like "the proposition 'there is an object whose length is 1 ft' proves itself, because I couldn't express the proposition at all if there were no object of that length". (That is, if I introduced the sign "*this* length" instead of "1 foot", then the statement that the unit rod is 1 foot long would mean "this rod has this length" (where I point both times to the same rod).) Similarly one cannot say of a group of strokes serving as a paradigm of 3, that it consists of 3 strokes.

"If the proposition isn't true, then the proposition doesn't exist" means: "if the proposition doesn't exist, then it doesn't exist". And one proposition can never describe the paradigm in another, unless it ceases to be a paradigm. If the length of the unit rod can be described by assigning it the length "1 foot", then it isn't the paradigm of the unit of length; if it were, every statement of length would have to be made by means of it.

If we can give any sense at all to a proposition of the form " $\sim(\exists \phi): (\exists x). \phi x$ " it must be a proposition like: "there is no circle on this surface containing only *one* black speck" (I mean: it must have that sort of *determined* sense, and not remain vague as it did in Russellian logic and in my logic in the *Tractatus*).

If it follows from the propositions

$$\rho) \sim(\exists \phi): (\exists x). \phi x$$

$$\text{and } \sigma) \sim(\exists \phi): (\exists x, y). \phi x. \phi y$$

that $1 = 2$, then here "1" and "2" don't mean what we commonly

mean by them, because in word-language the propositions ρ and σ would be "there is no function that is satisfied by only one thing" and "there is no function that is satisfied by only two things." And according to the rules of our language these are propositions with different senses.

One is tempted to say: "In order to express ' $(\exists x, y). \phi x. \phi y$ ' we need 2 signs 'x' and 'y'." But that has no meaning. What we *need* for it, is, perhaps, pen and paper; and the proposition means no more than "to express 'p' we need 'p'."

If we ask: but what then does " $5 + 7 = 12$ " mean--what kind of significance or point is left for this expression after the elimination of the tautologies, etc. from the arithmetical calculus?--the answer is: this equation is a replacement rule which is based on certain general replacement rules, the rules of addition. The content of $5 + 7 = 12$ (supposing someone didn't know it) is precisely what children find difficult when they are learning this proposition in arithmetic lessons.

No investigation of concepts, only insight into the number-calculus can tell us that $3 + 2 = 5$. That is what makes us rebel against the idea that

" $(\exists x)\phi x \cdot (\exists x)\psi x \text{ Ind.} : \supset (\exists x)\phi x \vee \psi x$ "†1

could be the proposition $3 + 2 = 5$. For what enables us to tell that this expression is a tautology cannot itself be the result of an examination of concepts, but must be recognizable from the calculus. For the grammar is a calculus. That is, nothing of what the tautology calculus contains apart from the number calculus serves to justify it and if it is number we are interested in the rest is mere decoration.

Children learn in school that $2 \times 2 = 4$, but not that $2 = 2$.

Statements of number within mathematics

What distinguishes a statement of number about a concept from one about a variable? The first is a proposition about the concept, the second a grammatical rule concerning the variable.

But can't I specify a variable by saying that its values are to be all objects satisfying a certain function? In that way I do not indeed *specify* the variable unless I *know* which objects satisfy the function, that is, if these objects are given me in another way (say by a list); and then giving the function becomes superfluous. If we do not know whether an object satisfies the function, then we do not know whether it is to be a value of the variable, and the grammar of the variable is in that case simply not expressed in this respect.

Statements of number *in* mathematics (e.g. "The equation $x^2 = 1$ has 2 roots") are therefore quite a different kind of thing from statements of number outside mathematics ("There are 2 apples on the table").

If we say that A B admits of 2 permutations, it sounds as if we had made a *general* assertion, analogous to "There are 2 men in the room" in which nothing further is said or need be known about the men. But this isn't so in the A B case. I cannot give a more general description of A B, B A and so the proposition that no permutations are possible cannot say less than that the permutations A B, B A are possible. To say that 6 permutations of 3 elements are possible cannot say less, i.e. anything more general, than is shown by the schema:

A B C
A C B
B A C
B C A
C A B
C B A

For it's *impossible* to know the number of possible permutations without knowing which they are. And if this weren't so, the theory of combinations wouldn't be capable of arriving at its general formulae. The law which we see in the formulation of the permutations is represented by the equation $p = n!$ In the same sense, I believe, as that in which a circle is given by its equation.--Of course I can correlate the number 2 with the permutations A B, B A just as I can 6 with the complete set of permutations of A, B, C, but that does not give me the theorem of combination theory.--What I see in A B, B A is an internal relation which therefore cannot be described. That is, *what* cannot be described is that which makes this class of permutations complete.--I can only count what is actually there, not possibilities. But I can e.g. work out how many rows a man must write if in each row he puts a permutation of 3 elements and goes on until he cannot go any further without repetition. And this means, he needs 6 rows to write down the permutations A B C, A C B, etc., since these just are "*the* permutations of A, B, C". But it makes no sense to say that these are all permutations of A B C.

We could imagine a combination computer exactly like the Russian abacus.

It is clear that there is a mathematical question: "How many permutations of--say--4 elements are there?", a question of precisely the same kind as "What is 25×18 ?". For in both cases there is a general method of solution.

Page 349

But still it is only with respect to this method that this question exists.

Page 349

The proposition that there are 6 permutations of 3 elements is identical with the permutation schema and thus there isn't here a proposition "There are 7 permutations of 3 elements", for no such schema corresponds to it.

Page Break 350

Page 350

You could also conceive the number 6 in this case as another kind of number, the permutation-number of A, B, C. Permutation as another kind of counting.

Page 350

If you want to know what a proposition means, you can always ask "How do I know that?" Do I know that there are 6 permutations of 3 elements in the same way in which I know that there are 6 people in this room? No. Therefore the first proposition is of a different *kind* from the second.

Page 350

You may also say that the proposition "There are 6 permutations of 3 elements" is related to the proposition "There are 6 people in this room" in precisely the same way as is " $3 + 3 = 6$ ", which you could also cast in the form "There are 6 units in $3 + 3$ ". And just as in the one case I can count the rows in the permutation schema, so in the other I can count the strokes in

|||
|||

Just as I can prove that $4 \times 3 = 12$ by means of the schema

○ ○ ○
○ ○ ○
○ ○ ○
○ ○ ○

I can also prove $3! = 6$ by means of the permutation schema.

Page 350

The proposition "the relation R links two objects", if it is to mean the same as "R is a two-place relation", is a proposition of grammar.

Page Break 351

Page 351

How should we regard the propositions "these hats are of the same size", or "these rods have the same length" or "these patches have the same colour"? Should we write them in the form " $(\exists L).La. Lb$ "? But if that is intended in the usual way, and so is used with the usual rules, it would mean that it made sense to write " $(\exists L).La$ ", i.e. "the patch has a colour", "the rod has a length". Of course I can write " $(\exists L).La.Lb$ " for "a and b have the same length" provided that I know and bear in mind that " $(\exists L).La$ " is senseless; but then the notation becomes misleading and confusing ("to have a length", "to have a father").--What we have here is something that we often express in ordinary language as follows: "If a has the length L, so does b"; but here the sentence "a has the length L" has no sense, or at least not as a statement about a; the proposition should be reworded "if we call the length of a 'L', then the length of b is L" and 'L' here is essentially a variable. The proposition incidentally has the form of an example, of a proposition that could serve as an example for the general sentence; we might go on: "for example, if the length of a is 5 metres, then the length of b is 5 metres, etc."--Saying "the rods a and b have the same length" says nothing about the length of each rod; for it doesn't even say "that each of the two has a length". So it is quite unlike "A and B have the same father" and "the name of the father of A and B is 'N'", where I simply substitute the proper name for the general description. It is not that there is a certain length of which we are at first only told that a and b both possess it, and of which '5m' is the name. If the lengths are lengths in the visual field we can say the two lengths are the same, without in general being able to "name" them with a number.--The written form of the proposition "if L is the length of a, the length of b too is L" is derived from the form of an example. And we might express the general proposition by actually enumerating

examples and adding "etc.". And If I say, "a and b are the same length; if the length of a is L, then the length of b is L; if a is 5 m long then b is 5 m long, if a is 7 m long, then b is 7 m long, etc.", I am repeating the same proposition. The third formulation shows that the "and" in the proposition doesn't stand between two forms, as it does in " $(\exists x).\phi x.\psi x$ ", where one can also write " $(\exists x).\phi x$ " and " $(\exists x).\psi x$ ".

Let us take as an example the proposition "there are the same number of apples in each of the two boxes". If we write this proposition in the form "there is a number that is the number of the apples in each of the boxes" here too we cannot construct the form "there is a number that is the number of apples in this box" or "the apples in this box have a number". If I write: $(\exists x).\phi x.\sim(\exists x, y).\phi x.\phi y. = .(\exists_n 1x).\phi x. = \phi 1$, etc. then we might write the proposition "the number of apples in both boxes is the same" as " $(\exists x).\phi n.\psi n$ ". But " $(\exists n).\phi n$ " would not be a proposition.

If you want to write the proposition "the same number of objects fall under ϕ and ψ " in a perspicuous notation, the first temptation is to write it in the form " $\phi n.\psi n$ ". And that doesn't feel as if it were a logical product of ϕn and ψn , which would mean that it made sense to write $\phi n.\psi 5$; it is essential that the same letter should follow ψ as follows ϕ , and $\phi n.\psi n$ is an abstraction from the logical products $\phi 4.\psi 4$, $\phi 5.\psi 5$, etc., rather than itself a logical product. (So ϕn doesn't follow from $\phi n.\psi n$. The relation of $\phi n \cdot \psi n$ to a logical product is more like that of a differential quotient to a quotient.) It is no more a logical product than the photograph of a family group is a group of photographs. Therefore the form " $\phi n.\psi n$ " can be misleading and perhaps we should prefer a notation of the form " $\overline{\phi n, \psi n}$ "; or even " $(\exists n).\phi n.\psi n$ ", provided that the grammar of this sign is fixed. We can then stipulate $(\exists n).\phi n = \text{Taut.}$, which is the same as $(\exists n).\phi n.p. = .p$.

Therefore $(\exists n).\phi n \vee \psi n. = \text{Taut.}$, $(\exists n).\phi n. \supset \psi n. = \text{Taut.}$, $(\exists n).\phi n|\psi n. = \text{Cont.}$, etc.

$$\begin{aligned} \phi 1.\psi 1.(\exists n).\phi n.\psi n &= .\phi 1.(\exists n).\phi n.\psi n \\ \phi 2.\psi 2.(\exists n).\phi n.\psi n &= .\phi 2.(\exists n).\phi n.\psi n \\ \text{etc. ad inf.} \end{aligned}$$

And in general the calculation rules for $(\exists n)\phi n.\psi n$ can be derived from the fact that we can write

$$(\exists n).\phi n.\psi n = \phi 0.\psi 0. \vee .\phi 1.\psi 1. \vee .\phi 2.\psi 2. \vee .\phi 3.\psi 3$$

and so on ad inf.

It is clear that this is not a logical sum, because "and so on ad inf." is not a sentence. The notation $(\exists n).\phi n.\psi n$ however is not proof against misunderstanding, because you might wonder why you shouldn't be able to put Φn instead of $\phi n.\psi n$ though if you did $(\exists n).\Phi n$ should of course be meaningless. Of course we can clear that up by going back to the notation $\sim(\exists x).\phi x$ for $\phi 0$, $(\exists x)\phi x.\sim(\exists x,y).\phi x.\phi y$ for $\phi 1$, etc., i.e. to $(\exists_n 0x).\phi x$ for $\phi 0$, $(\exists_n 1x).\phi x$ for $\phi 1$ respectively, and so on. For then we can distinguish between

$$(\exists_n 1x).\phi x(\exists_n 1x).\psi x \text{ and } (\exists_n 1x).\phi x.\psi x$$

And if we go back to $(\exists n).\phi n.\psi n$, that means $(\exists n):(\exists_n nx).\phi x.(\exists_n nx).\psi x$ (which is not nonsensical) and not $(\exists n):(\exists_n nx).\phi x.\psi x$, which is nonsensical.

The expressions "same number", "same length", "same colour", etc. have grammars which are similar but not the same. In each case it is tempting to regard the proposition as an endless logical sum whose terms have the form $\phi n.\psi n$. Moreover, each of these words has several different meanings, i.e. can itself be replaced by several words with different grammars. For "same number" does not mean the same when applied to lines simultaneously present in the visual field as in connection with the apples in two boxes; and "same length" applied in visual space is different from "same length" in Euclidean space; and the meaning of "same colour" depends on the criterion we adopt for sameness of colour.

If we are talking about patches in the visual field seen simultaneously, the expression "same length" varies in

meaning

Page Break 354

depending on whether the lines are immediately adjacent or at a distance from each other. In word-language we often get out of the difficulty by using the expression "it looks".

Page 354

Sameness of number, when it is a matter of a number of lines "that one can take in at a glance", is a different sameness from that which can only be established by counting the lines.

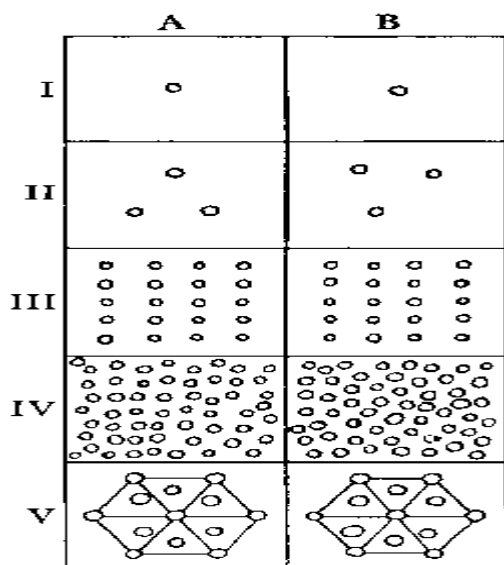

Page 354

Different criteria for sameness of number: in I and II the number that one immediately recognizes; in III the criterion of correlation; in IV we have to count both groups; in V we recognize the same pattern. (Of course these are not the only cases.)

Page 354

We want to say that equality of length in Euclidean space consists in both lines measuring the same number of cm, both 5 cm, both 10 cm etc.; but where it is a case of two lines in visual space being equally long, there is no length L that both lines have.

Page Break 355

Page 355

One wants to say: two rods must always have either the same length or different lengths. But what does that mean? What it is, of course, is a rule about modes of expression. "There must either be the same number or a different number of apples in the two boxes." The method whereby I discover whether two lines are of the same length is supposed to be the laying of a ruler against each line: but do they have the same length when the rulers are *not* applied? In that case we would say we don't know whether during that time the two lines have the same or different lengths. But we might also say that during that time they have no length, or perhaps no numerical length.

Page 355

Something similar, if not exactly the same, holds of sameness between numbers.

Page 355

When we cannot immediately see the number of dots in a group, we can sometimes keep the group in view as a whole while we count, so that it makes sense to say it hasn't altered during the counting. It is different when we have a group of bodies or patches that we cannot keep in a single view while we count them, so that we don't have the same criterion for the group's not changing while it is counted.

Page 355

Russell's definition of sameness of number is unsatisfactory for various reasons. The truth is that in mathematics we don't need any such definition of sameness of number. He puts the cart before the horse.

Page 355

What seduces us into accepting the Russellian or Fregean explanation is the thought that two classes of objects (apples in two boxes) have the same number if they *can* be correlated 1 to 1. We imagine correlation as a check of sameness of number. And here we do distinguish in thought between being correlated and being connected by a relation; and correlation becomes something that is related to connection as the "geometrical straight line" is

related to a real line, namely a kind of ideal connection that is as it were sketched in advance by Logic so that reality only has to trace it. It is possibility conceived as a shadowy actuality. This in turn is connected with the idea of $(\exists x).\phi x$ as an expression of the possibility of ϕx .

" ϕ and ψ have the same number" (I will write this " $S(\phi, \psi)$ " or simply " S ") is supposed to follow from " $\phi 5.\psi 5$ "; but it doesn't follow from $\phi 5.\psi 5$ that ϕ and ψ are connected by a 1-1 relation R (this I will write $\Pi(\phi, \psi)$ or " Π "). We get out of the difficulty by saying that in that case there is a relation like

$$"x = a.y = b. \vee .x = c.y = d.\vee., \text{ etc.}"$$

But if so, then in the first place why don't we define S without more ado as the holding of such a relation? And if you reply that this definition wouldn't include sameness of number in the case of infinite numbers, we shall have to say that this only boils down to a question of "elegance", because for finite numbers in the end I have to take refuge in "extensional" relations. But these too get us nowhere; because saying that between ϕ and ψ there holds a relation e.g. of the form $x = a.y = b. \vee .x = c.y = d$ says only that

$$(\exists x, y).\phi x.\psi y.\sim(\exists x, y, z).\phi x.\phi y.\phi z:(\exists x, y)\psi x.\psi y.\sim(\exists x, y, z).\psi x.\psi y.\psi z.$$

(Which I write in the form

$$(\exists_n 2x).\phi x.(\exists_n 2x).\psi x.)$$

And saying that between ϕ and ψ there holds *one* of the relations $x = a.y = b; x = a.y = b. \vee .x = c.y = d$; etc. etc. means only that there obtains one of the facts $\phi 1.\psi 1; \phi 2.\psi 2$ etc. etc. Then we retreat into greater generality, saying that between ϕ and ψ there holds *some* 1-1 relation, forgetting that in order to specify this generality we have to make the rule that "some relation" includes also relations of the form $x = a.y = b$, etc. By saying more one does

not avoid saying the less that is supposed to be contained in the more. Logic cannot be duped.

So in the sense of S in which S follows from $\phi 5.\psi 5$, it is not defined by Russell's definition. Instead, what we need is a series of definitions.

$$\left. \begin{array}{l} \phi_0.S = \phi_0.\psi_0 = \psi_0.S \\ \phi_1.S = \phi_1.\psi_1 = \psi_1.S \\ \text{etc. ad inf.} \end{array} \right\} \dots \alpha$$

On the other hand Π is used as a criterion of sameness of number and of course *in another sense of S* it can also be equated with S . (And then we can only say: if in a given notation $S = \Pi$, then S means the same as Π .)

Though Π does not follow from $\phi 5.\psi 5$, $\phi 5.\psi 5$ does from $\Pi.\phi 5$.

$$\Pi.\phi 5 = \Pi.\phi 5.\psi 5 = \Pi.\psi 5$$

etc.

We can therefore write:

$$\begin{array}{l} \Pi.\phi 0 = \Pi.\phi 0.\psi 0 = \Pi.\psi 0.S \\ \Pi.\phi 1 = \Pi.\phi 1.\psi 1 = \Pi.\psi 1.S \quad \dots \beta \\ \Pi.\phi 2 = \Pi.\phi 2.\psi 2 = \Pi.\psi 2.S \\ \text{and so on ad inf.} \end{array}$$

And we can express this by saying that the sameness of number follows from Π . And we can also give the rule $\Pi.S = \Pi$; it accords with the rules, or *the* rule, β and the rule α .

We could perfectly well drop the rule " S follows from Π ", that is, $\Pi.S = \Pi$; the rule β does the same job.

If we write S in the form

$\phi_0.\psi_0. \vee.\phi_1.\psi_1. \vee.\phi_2.\psi_2. \vee\dots$ ad inf.

we can easily derive $\Pi.S = \Pi$ by grammatical rules that correspond to ordinary language. For

$(\phi_0.\psi_0. \vee.\phi_1.\psi_1. \vee \text{etc. ad inf.}).\Pi = \phi_0.\psi_0.\Pi. \vee.\phi_1.\psi_1 \Pi. \vee \text{etc. ad inf.} = \phi_0.\Pi. \vee \phi_1.\Pi. \vee \phi_2.\Pi. \vee . \text{etc. ad inf.} = \Pi.(\phi_0 \vee \phi_1 \vee \phi_2 \vee \text{etc. ad inf.}) = \Pi$

The proposition " $\phi_0 \vee \phi_1 \vee \phi_2 \vee \text{etc. ad inf.}$ " must be treated as a tautology.

Page Break 358

⋮
-
▪ ▪
▪ ▪
▪ ▪
▪ ▪

We can regard the concept of sameness of number in such a way that it makes no sense to attribute sameness of number or its opposite to two groups of points except in the case of two series of which one is correlated 1-1 to at least a part of the other. Between such series all we can talk about is unilateral or mutual inclusion.

Page 358

This has really no more connection with particular numbers than equality or inequality of length in the visual field has with numerical measurement. We *can*, but need not, connect it with numbers. If we connect it with the number series, then the relation of mutual inclusion or equality of length between the rows becomes a relation of sameness of number. But then it isn't only that ψ_5 follows from $\Pi.\phi_5$. We also have Π following from $\phi_5.\psi_5$. That means that here $S = \Pi$.

Page Break 359

V MATHEMATICAL PROOF

22

In other cases, if I am looking for something, then even before it is found I can describe what finding it is; not so, if I am looking for the solution of a mathematical problem.

Mathematical Expeditions and Polar Expeditions

Page 359

How can there be conjectures in Mathematics? Or better, what sort of thing is it that looks like a conjecture in mathematics? Such as making a conjecture about the distribution of the primes.

Page 359

I might e.g. imagine that someone is writing primes in series in front of me without my knowing they are the primes--I might for instance believe he is writing numbers just as they occur to him--and I now try to detect a law in them. I might now actually form an hypothesis about this number sequence, just as I could about any sequence yielded by an experiment in physics.

Page 359

Now in what sense have I, by so doing, made an hypothesis about the distribution of the primes?

Page 359

You might say that an hypothesis in mathematics has the value that it trains your thoughts on a particular object--I mean a particular region--and we might say "we shall surely discover something interesting about these things".

Page 359

The trouble is that our language uses each of the words "question", "problem", "investigation", "discovery", to refer to such basically different things. It's the same with "inference", "proposition", "proof".

Page 359

The question again arises, what kind of verification do I count as valid for my hypothesis? Or can I *faute de mieux* allow an empirical one to hold for the time being until I have a "strict proof"? No. Until there is such a proof, there is no connection at all between my hypothesis and the "concept" of a prime number.

Page Break 360

Only the so-called proof establishes any connection between the hypothesis and the primes *as such*. And that is shown by the fact that--as I've said--until then the hypothesis can be construed as one belonging purely to physics.--On the other hand when we have supplied a proof, it doesn't prove what was conjectured at all, since I can't conjecture to infinity. I can only conjecture what can be confirmed, but experience can only confirm a finite number of conjectures, and you can't conjecture the proof until you've got it, and not then either.

Suppose that someone, without having proved Pythagoras' theorem, has been led by measuring the sides and hypoteneuses of right angled triangles to "conjecture" it. And suppose he later discovered the proof, and said that he had then proved what he had earlier conjectured. At least one remarkable question arises: at what point of the proof does what he had earlier confirmed by individual trials emerge? For the proof is essentially different from the earlier method.--Where do these methods make contact, if the proof and the tests are only different aspects of the same thing (the same generalisation) if, as alleged, there is some sense in which they give the same result?

I have said: "from a single source only one stream flows", and one might say that it would be odd if the same thing were to come from such different sources. The thought that the same thing can come from different sources is familiar from physics, i.e. from hypotheses. In that area we are always concluding from symptoms to illnesses and we know that the most different symptoms can be symptoms of the same thing.

How could one guess from statistics the very thing the proof later showed?

How can the proof produce the same generalisation as the earlier trials made probable?

I am assuming that I conjectured the generalisation without conjecturing the proof. Does the proof now prove exactly the generalisation that I conjectured?!

Suppose someone was investigating even numbers to see if they confirmed Goldbach's conjecture. Suppose he expressed the conjecture--and it can be expressed--that if he continued with this investigation, he would never meet a counterexample as long as he lived. If a proof of the theorem is then discovered, will it also be a proof of the man's conjecture? How is that possible?

Nothing is more fatal to philosophical understanding than the notion of proof and experience as two different but comparable methods of verification.

What kind of discovery did Sheffer make when he found that $p \vee q$ and $\sim p$ can be expressed by $p|q$? People had no method of looking for $p|q$, and if someone were to find one today, it wouldn't make any difference.

What was it we didn't know before the discovery? (It wasn't anything that we didn't know, it was something with which we weren't acquainted.)

You can see this very clearly if you imagine someone objecting that $p|p$ isn't at all the same as is said by $\sim p$. The reply of course is that it's only a question of the system $p|q$, etc. having the necessary multiplicity. Thus Sheffer found a symbolic system with the necessary multiplicity.

Does it count as looking for something, if I am unaware of Sheffer's system and say I would like to construct a system with only *one* logical constant? No!

Systems are certainly not all in *one* space, so that I could say: there are systems with 3 and with 2 logical constants and now I am trying to reduce the number of constants *in the same way*. There is no "*same way*" here.

Suppose prizes are offered for the solution--say--of Fermat's problem. Someone might object to me: How can you say that this problem doesn't exist? If prizes are offered for the solution, then surely the problem must exist. I would have to say: Certainly, but the people who talk about it don't understand the grammar of the expression

"mathematical problem" or of the word "solution". The prize is really offered for the solution of a scientific problem; for the *exterior* of the solution (hence also for instance we talk about a Riemannian *hypothesis*). The conditions of the problem are external conditions; and when the problem is solved, what happens corresponds to the setting of the problem in the way in which solutions correspond to problems in physics.

Page 362

If we set as a problem to find a construction for a regular pentagon, the way the construction is specified in the setting of the problem is by the physical attribute that it is to yield a pentagon that *is shown by measurement* to be regular. For we don't get the concept of *constructive division into five* (or of a *constructive pentagon*) until we get it from the construction.

Page 362

Similarly in Fermat's theorem we have an empirical structure that we interpret as a *hypothesis*, and not--of course--as the product of a construction. So in a certain sense what the problem asks for is not what the solution gives.

Page 362

Of course a proof of the contradictory of Fermat's theorem (for instance) stands in the same relation to the problem as a proof of the proposition itself. (Proof of the impossibility of a construction.)

Page 362

We can represent the impossibility of the trisection of an angle as a physical impossibility, by saying things like "don't try to divide the angle into 3 equal parts, it is hopeless!" But in so far as we can do that, it is not *this* that the "proof of impossibility" proves. That it is *hopeless* to attempt the trisection is something connected with physical facts.

Page Break 363

Page 363

Imagine someone set himself the following problem. He is to discover a game played on a chessboard, in which each player is to have 8 pieces; the two white ones which are in the outermost files at the beginning of the game (the "consuls") are to be given some special status by the rules so that they have a greater freedom of movement than the other pieces; one of the black pieces (the "general") is to have a special status; a white piece takes a black one by being put in its place (and vice versa); the whole game is to have a certain analogy with the Punic wars. Those are the conditions that the game is to satisfy.--There is no doubt that that is a problem, a problem not at all like the problem of finding out how under certain conditions white can win in chess.--But now imagine the problem: "How can white win in 20 moves in the war-game whose rules we don't yet know precisely?"--That problem would be quite analogous to the problems of mathematics (other than problems of calculation).

Page 363

What is hidden must be capable of being found. (Hidden contradictions.)

Page 363

Also, what is hidden must be completely describable before it is found, no less than if it had already been found.

Page 363

It makes good sense to say that an object is so well hidden that it is impossible to find it; but of course the impossibility [[sic]] here is not a logical one; i.e. it makes *sense* to speak of finding an object to describe the finding; we are merely denying that it will happen.

Page 363

[We might put it like this: If I am looking for something,--I mean, the North Pole, or a house in London--I can *completely* describe what I am looking for before I have found it (or have found that it isn't there) and either way this description will be logically acceptable. But when I'm "looking for" something in mathematics, unless I am doing so *within* a system, what I am looking for cannot be described, or can only apparently be described; for if I could describe it in every particular, I would already

Page Break 364

actually *have* it; and before it is *completely* described I can't be sure whether *what* I am looking for is logically acceptable, and therefore describable at all. That is to say, the incomplete description leaves out just what is necessary for something to be capable of being looked for at all. So it is only an apparent description of what is being "looked for."†1

Page 364

Here we are easily misled by the legitimacy of an incomplete description when we are looking for a real object, and here again there is an unclarity about the concepts "description" and "object". If someone says, I am

going to the North Pole and I expect to find a flag there, that would mean, on Russell's account, I expect to find something (an x) that is a flag--say of such and such a colour and size. In that case too it looks as if the expectation (the search) concerns only an indirect knowledge and not the object itself; as if that is something that I don't really know (knowledge by acquaintance) until I have it in front of me (having previously been only indirectly acquainted with it). But that is nonsense. There whatever I can perceive--to the extent that it is a fulfilment of my expectation--I can also describe in advance. And here "describe" means not saying something or other about it, but rather expressing it. That is, if I am looking for something I must be *able* to describe it *completely*.

Page 364

The question is: can one say that at present mathematics is as it were jagged--or frayed--and for that reason we shall be able to round it off? I think you can't say that, any more than you can say that reality is untidy, because there are 4 primary colours, seven notes in an octave, three dimensions in visual space, etc.

Page 364

You can't round off mathematics any more than you can say "let's round off the four primary colours to eight or ten" or "let's round off the eight tones in an octave to ten".

Page Break 365

Page 365

The comparison between a mathematical expedition and a polar expedition. There is a point in drawing this comparison and it is a very useful one.

Page 365

How strange it would be if a geographical expedition were uncertain whether it had a goal, and so whether it had any route whatsoever. We can't imagine such a thing, it's nonsense. But this is precisely what it is like in a mathematical expedition. And so perhaps it is a good idea to drop the comparison altogether.

Page 365

Could one say that arithmetical or geometrical problems can always look, or can falsely be conceived, as if they referred to objects in space whereas they refer to space itself?

Page 365

By "space" I mean what one can be *certain* of while searching.

Page Break 366

Proof and the truth and falsehood of mathematical propositions

Page 366

A mathematical proposition that has been proved has a bias towards truth in its grammar. In order to understand the sense of $25 \times 25 = 625$ I may ask: how is this proposition proved? But I can't ask how its contradictory is or would be proved, because it makes no sense to speak of a proof of the contradictory of $25 \times 25 = 625$. So if I want to raise a question which won't depend on the truth of the proposition, I have to speak of *checking* its truth, not of proving or disproving it. The method of checking corresponds to what one may call the sense of the mathematical proposition. The description of this method is a general one and brings in a system of propositions, for instance of propositions of the form $a \times b = c$.

Page 366

We can't say "I will work out *that* it is so", we have to say "*whether* it is so", i.e., whether it is *so* or otherwise.

Page 366

The method of checking the truth corresponds to the sense of a mathematical proposition. If it's impossible to speak of such a check, then the analogy between "mathematical proposition" and the other things we call propositions collapses. Thus there is a check for propositions of the form " $(\exists k)_n \dots$ " and " $\sim(\exists k)_n \dots$ " which bring in intervals.

Page 366

Now consider the question "does the equation $x^2 + ax + b = 0$ have a solution in the real numbers?". Here again there is a check and the check decides between $(\exists \dots)$, etc. and $\sim(\exists \dots)$, etc. But can I in the same sense also ask and check "whether the equation has a solution"? Not unless I include this case too in a system with others.

Page 366

(In reality the "proof of the fundamental theorem of algebra..." constructs a new kind of number.)

Equations are a kind of number. (That is, they can be treated similarly to the numbers.)

A "proposition of mathematics" that is proved by an induction is not a "proposition" in the same sense as the answer to a mathematical question unless one can look for the induction in a system of checks.

"Every equation G has a root." And suppose it has no root? Could we describe that case as we can describe its not having a rational solution? What is the criterion for an equation not having a solution? For this criterion must be given if the mathematical *question* is to have a sense and if the apparent existence proposition is to be a "proposition" in the sense of an answer to a question.

(What does the description of the contradictory consist of? What supports it? What are the examples that support it, and how are they related to particular cases of the proved contradictory? These questions are not side-issues, but absolutely essential.)

(The philosophy of mathematics consists in an exact scrutiny of mathematical proofs--not in surrounding mathematics with a vapour.)

In discussions of the provability of mathematical propositions it is sometimes said that there are substantial propositions of mathematics whose truth or falsehood must remain undecided. What the people who say that don't realize is that such propositions, *if* we can use them and want to call them "propositions", are not at all the same as what are called "propositions" in other cases; because a proof alters the grammar of a proposition. You can certainly use one and the same piece of wood first as a weathervane and then as a signpost; but you can't use it fixed as a weathervane and moving as a signpost. If some one wanted to say "There are also moving signposts" I would answer "You really mean 'There are also moving *pieces of wood*'. I don't say that a moving piece of wood can't possibly be used at all, but only that it can't be used as a signpost".

The word "proposition", if it is to have any meaning at all here, is equivalent to a calculus: to a calculus in which $p \vee \sim p$ is a tautology (in which the "law of the excluded middle" holds). When it is supposed not to hold, we have altered the concept of proposition. But that does not mean we have made a discovery (found something that is a proposition and yet doesn't obey such and such a law); it means we have made a new stipulation, or set up a new game.

If you want to know what is proved, look at the proof

Mathematicians only go astray, when they want to talk about calculi in general; they do so because they forget the particular stipulations that are the foundations of each particular calculus.

The reason why all philosophers of mathematics miss their way is that in logic, unlike natural history, one cannot justify generalizations by examples. Each particular case has maximum significance, but once you have it the story is complete, and you can't draw from it any general conclusion (or any conclusion *at all*).

There is no such thing as a logical fiction and hence you can't work with logical fictions; you have to work out each example fully.

In mathematics there can only be mathematical troubles, there can't be philosophical ones.

The philosopher only marks what the mathematician casually throws off about his activities.

The philosopher easily gets into the position of a ham-fisted director, who, instead of doing his own work and merely supervising his employees to see they do their work well, takes over their jobs until one day he finds himself overburdened with other people's work while his employees watch and criticize him. He is particularly

inclined to saddle himself with the work of the mathematician.

Page 369

If you want to know what the expression "continuity of a function" means, look at the proof of continuity; that will show what it proves. Don't look at the result as it is expressed in prose, or in the Russellian notation, which is simply a translation of the prose expression; but fix your attention on the calculation actually going

Page Break 370

on in the proof. The verbal expression of the allegedly proved proposition is in most cases misleading, because it conceals the real purport of the proof, which can be seen with full clarity in the proof itself.

Page 370

"Is the equation satisfied by any numbers?"; "It is satisfied by numbers"; "It is satisfied by all (no) numbers." Does your calculus have proofs? And what proofs? It is only from them that we will be able to gather the sense of these proportions and questions.

Page 370

Tell me *how* you seek and I will tell you *what* you are seeking.

Page 370

We must first ask ourselves: is the mathematical proposition proved? If so, how? For the proof is part of the grammar of the proposition!--The fact that this is so often not understood arises from our thinking once again along the lines of a misleading analogy. As usual in these cases, it is an analogy from our thinking in natural sciences. We say, for example, "this man died two hours ago" and if someone asks us "how can you tell that?" we can give a series of indications (symptoms). But we also leave open the possibility that medicine may discover hitherto unknown methods of ascertaining the time of death. That means that we can already describe such possible methods; it isn't their description that is discovered. What is ascertained experimentally is whether the description corresponds to the facts. For example, I may say: one method consists in discovering the quantity of haemoglobin in the blood, because this diminishes according to such and such a law in proportion to the time after death. Of course that isn't correct, but if it were correct, nothing in my imaginary description would change. If you call the medical discovery "the discovery of a proof that the man died two hours ago" you must go on to say that this discovery does not change anything in the grammar of the proposition "the man died two hours ago". The discovery is the discovery that a particular hypothesis is true (or: agrees with

Page Break 371

the facts). We are so accustomed to these ways of thinking, that we take the discovery of a proof in mathematics, sight unseen, as being the same or similar. We are wrong to do so because, to put it concisely, the mathematical proof couldn't be described before it is discovered.

Page 371

The "medical proof" didn't incorporate the hypothesis it proved into any new calculus, so it didn't give it any new sense; a mathematical proof incorporates the mathematical proposition into a new calculus, and alters its position in mathematics. The proposition with its proof doesn't belong to the same category as the proposition without the proof. (Unproved mathematical propositions--signposts for mathematical investigation, stimuli to mathematical constructions.)

Page 371

Are all the variables in the following equations variables of the same kind?

$$x^2 + y^2 + 2xy = (x + y)^2$$

$$x^2 + 3x + 2 = 0$$

$$x^2 + ax + b = 0$$

$$x^2 + xy + z = 0?$$

Page 371

That depends on the use of the equations.--But the distinction between no. 1 and no. 2 (as they are ordinarily used) is not a matter of the extension of the values satisfying them. How do you prove the proposition "No. 1 holds for all values of x and y" and how do you prove the proposition "there are values of x that satisfy No. 2?" There is no more and no less similarity between the senses of the two propositions than there is between the proofs.

Page 371

But can't I say of an equation "I know it doesn't hold for some substitutions--I've forgotten now *which*; but whether it doesn't hold in general, I don't know?" But what do you mean when you say you know that? How do you know? Behind the words "I know..." there isn't a certain state of mind to be the sense of those words. What can you do with that knowledge? That's what

will show what the knowledge consists in. Do you know a method for ascertaining that the equation doesn't hold in general? Do you remember that the equation doesn't hold for some values of x between 0 and 1000? Or did someone just show you the equation and say he had found values of x that didn't satisfy the equation, so that perhaps you don't yourself know how to establish it for a given value? etc. etc.

"I have worked out that there is no number that..."--In what system of calculation does that calculation occur?--That will show us to which proposition-system the worked-out proposition belongs. (One also asks: "how does one work out *something like that*?"")

"I have discovered that there is such a number."

"I have worked out that there is no such number."

In the first sentence I cannot substitute "no such" for "such a". What if in the second I put "such a" for "no such"? Let's suppose the result of a calculation isn't the proposition " $\sim(\exists n)$ " but " $(\exists n)$ etc." Does it then make sense to say something like "Cheer up! *Sooner or later* you must come to such a number, if only you try long enough"? That would only make sense if the result of the proof had not been " $(\exists n)$ etc." but something that sets limits to testing, and therefore a quite different result. That is, the contradictory of what we call an existence theorem, a theorem that tells us to look for a number, is not the proposition " (n) etc." but a proposition that says in such and such an interval there is no number which... What is the contradictory of what is proved?--For that you must look at the proof. We can say that the contradictory of a proved proposition is what would have been proved instead of it if a particular miscalculation had been made in the proof. If now, for instance, the proof that $\sim(\exists n)$ etc is the case is an induction that shows that however far I go such a number cannot occur, the contradictory of this proof (using this expression for the sake of argument) is not an existence proof in our sense. This case isn't like a proof that one or none of the numbers a, b, c, d has the

property ϵ ; and that is the case that one always has before one's mind as a paradigm. In that case I could make a mistake by believing that c had the property and after I had seen the error I would know that *none* of the numbers had the property. But at this point the analogy just collapses.

(This is connected with the fact that I can't eo ipso use the negations of equations in every calculus in which I use equations. For $2 \times 3 \neq 7$ doesn't mean that the equation $2 \times 3 = 7$ isn't to occur, like the equation $2 \times 3 = \text{sine}$; the negation is an exclusion within a predetermined system. I can't negate a definition as I can negate an equation derived by rules.)

If you say that in an existence proof the interval isn't essential, because another interval might have done as well, of course that doesn't mean that not specifying an interval would have done as well.--The relation of a proof of non-existence to a proof of existence is not the same as that of a proof of p to a proof of its contradictory.

One should suppose that in a proof of the contradictory of " $(\exists n)$ " it must be possible for a negation to creep in which would enable " $\sim(\exists n)$ " to be proved erroneously. Let's for once start at the other end with the proofs, and suppose we were shown them first and then asked: what do these calculations prove? Look at the proofs and *then* decide what they prove.

I don't need to *assert* that it must be possible to construct the n roots of equations of the n -th degree; I merely say that the proposition "this equation has n roots" hasn't *the same* meaning if I've proved it by enumerating the constructed roots as if I've proved it in a different way. If I find a formula for the roots of an equation, I've constructed a new calculus; I haven't filled in a gap in an old one.

Hence it is nonsense to say that the proposition isn't proved until such a construction is produced. For when we do that we construct

something new, and what we now mean by the fundamental theorem of algebra is what the present 'proof' shows us.

"Every existence proof must contain a construction of what it proves the existence of." You can only say "I won't call anything an 'existence proof' unless it contains such a construction". The mistake lies in pretending to possess a clear *concept* of existence.

Page 374

We think we can prove a something, existence, in such a way that we are then convinced of it *independently of the proof*. (The idea of proofs independent of each other--and so presumably independent of what is proved.) Really, existence is what is proved by the procedures we call "existence proofs". When the intuitionists and others talk about this they say: "This state of affairs, existence, can be proved only thus and not thus." And they don't see that by saying that they have simply defined what *they* call existence. For it isn't at all like saying "that a man is in the room can only be proved by looking inside, not by listening at the door".

Page 374

We have no concept of existence independent of our concept of an existence proof.

Page 374

Why do I say that we don't discover a proposition like the fundamental theorem of algebra, and that we merely construct it?--Because in proving it we give it a new sense that it didn't have before. Before the so-called proof there was only a rough pattern of that sense in the word-language.

Page 374

Suppose someone were to say: chess only had to be *discovered*, it was always there! Or: the *pure* game of chess was always there; we only made the material game alloyed with matter.

Page 374

If a calculus in mathematics is altered by discoveries, can't we preserve the old calculus? (That is, do we have to throw it away?)

Page Break 375

That is a very interesting way of looking at the matter. After the discovery of the North Pole we don't have two earths, one with and one without the North pole. But after the discovery of the law of the distribution of the primes, we do have two kinds of primes.

Page 375

A mathematical question must be no less exact than a mathematical proposition. You can see the misleading way in which the mode of expression of word-language represents the sense of mathematical propositions if you call to mind the multiplicity of a mathematical proof and consider that the proof belongs to the *sense* of the proved proposition, i.e. determines that sense. It isn't something that brings it about that we believe a particular proposition, but something that shows us *what* we believe--if we can talk of believing here at all. In mathematics there are concept words: cardinal number, prime number, etc. That is why it seems to make sense straight off if we ask "how many prime numbers are there?" (Human beings believe, if only they hear words...) In reality this combination of words is so far nonsense; until it's given a special syntax. Look at the proof "that there are infinitely many primes," and then at the question that it appears to answer. The result of an intricate proof can have a simple verbal expression only if the system of expressions to which this expression belongs has a multiplicity corresponding to a system of such proofs. Confusions in these matters are entirely the result of treating mathematics as a kind of natural science. And this is connected with the fact that mathematics has detached itself from natural science; for, as long as it is done in immediate connection with physics, it is clear that *it* isn't a natural science. (Similarly, you can't mistake a broom for part of the furnishing of a room as long as you use it to clean the furniture).

Page 375

The main danger is surely that the prose expression of the result of a mathematical operation may give the illusion of a calculus that doesn't exist, by bearing the outward appearance of belonging to a system that isn't there at all.

Page Break 376

Page 376

A proof is a proof of a particular proposition if it goes by a rule correlating the proposition to the proof. That is, the proposition must belong to a system of propositions, and the proof to a system of proofs. And every proposition in mathematics must belong to a calculus of mathematics. (It cannot sit in solitary glory and refuse to mix with other propositions.)

Page 376

So even the proposition "every equation of nth degree has n roots" isn't a proposition of mathematics unless it corresponds to a system of propositions and its proof corresponds to an appropriate system of proofs. For what good reason have I to correlate that chain of equations etc. (that we call the proof) to *this* prose sentence? Must it

not be clear--according to a rule--from the proof itself which proposition it is a proof of?

Page 376

Now it is a part of the nature of *what we call propositions* that they must be capable of being negated. And the negation of what is proved also must be connected with the proof; we must, that is, be able to show in what different, contrasting, conditions it would have been the result.

Page Break 377

25
*Mathematical problems,
Kinds of problem,
Search
"Projects" in mathematics*

Page 377

Where you can ask you can look for an answer, and where you cannot look for an answer you cannot ask either. Nor can you find an answer.

Page 377

Where there is no method of looking for an answer, there the question too cannot have any sense.--Only where there is a method of solution is there a question (of course that doesn't mean: "only where the solution has been found is there a question"). That is: where we can only expect the solution of the problem from some sort of revelation, there isn't even a question. To a revelation no question corresponds.

Page 377

The supposition of undecidability presupposes that there is, so to speak, an underground connection between the two sides of an equation; that though the bridge cannot be built in symbols, it does exist, because otherwise the equation would lack sense.--But the connection only exists if we have made it by symbols; the transition isn't produced by some dark speculation different in kind from what it connects (like a dark passage between two sunlit places).

Page 377

I cannot use the expression "the equation E yields the solution S" unambiguously until I have a method of solution; because "yields" refers to a structure that I cannot designate unless I am acquainted with it. For that would mean using the word "yields" without knowing its grammar. But I might also say: When I use the word "yields" in such a way as to bring in a method of solution, it doesn't have the same meaning as when this isn't the case. Here the word "yields" is like the word "win" (or "lose") when at one time the criterion for "winning" is a particular set of events in the game (in that case I must know the rules of the game in order to be able to say that someone has won) and at another by "winning"

Page Break 378

I mean something that I could express roughly by "must pay".

Page 378

If we employ "yields" in the first meaning, then "the equation yield S" means: if I transform the equation in accordance with certain rules, I get S. Just as the equation $25 \times 25 = 620$ says that I get 620 if I apply the rules for multiplication to 25×25 . But in this case these rules must already be given to me before the word "yields" has a meaning, and before the question whether the equation yields S has a sense.

Page 378

It is not enough to say "p is provable"; we should say: provable according to a particular system.

Page 378

And indeed the proposition doesn't assert that p is provable according to the system S, but according to its own system, the system that p belongs to. That p belongs to the system S cannot be asserted (that has to show itself).--We can't say, p belongs to the system S; we can't ask, to which system does p belong; we cannot search for p's system. "To understand p" means, to know its system. If p appears to cross over from one system to another, it has in fact changed its sense.

Page 378

It is impossible to make discoveries of novel rules holding of a form already familiar to us (say the sine of an angle). If they are new rules, then it is not the old form.

Page 378

If I know the rules of elementary trigonometry, I can check the proposition $\sin 2x = 2 \sin x \cdot \cos x$, but not the

proposition $\sin x = \frac{x}{3!} + \frac{x^5}{5!} \dots$ but that means that the sine function of elementary trigonometry and that of

higher trigonometry are different concepts.

Page 378

The two propositions stand as it were on two different planes. However far I travel on the first plane I will never come to the proposition on the higher plane.

Page 378

A schoolboy, equipped with the armoury of elementary trigonometry and asked to test the equation $\sin x = x - \frac{x^3}{3!}$ simply wouldn't find what he needs to tackle the problem. He not merely couldn't answer the question, he couldn't even understand it.

Page Break 379

(It would be like the task the prince set the smith in the fairy tale: fetch me a 'Fiddle-de-dee'. Busch, *Volksmärchen*).

Page 379

We call it a problem, when we are asked "how many are 25×16 ", but also when we are asked: what is $\int \sin^2 x \, dx$. We regard the first as much easier than the second, but we don't see that they are "problems" in different senses. *Of course* the distinction is not a psychological one; it isn't a question of whether the pupil can solve the problem, but whether the calculus can solve it, or which calculus can solve it.

Page 379

The distinctions to which I can draw attention are ones that are familiar to every schoolboy. Later on we look down on those distinctions, as we do on the Russian abacus (and geometrical proofs using diagrams); we regard them as inessential, instead of seeing them as essential and fundamental.

Page 379

Whether a pupil *knows a rule* for ensuring a solution to $\int \sin^2 x \, dx$ is of no interest; what does interest us is whether the *calculus* we have before us (and that he happens to be using) contains such a rule.

Page 379

What interests us is not whether the pupil can do it, but whether the calculus can do it, and *how it* does it.

Page 379

In the case of $25 \times 16 = 370$ the calculus we use prescribes every step for the checking of the equation.

Page 379

"I *succeeded* in proving this" is a remarkable expression. (That is something no one would say in the case of $25 \times 16 = 400$).

Page 379

One could lay down: "whatever one can tackle is a problem.--Only where there can be a problem, can something be asserted."

Page Break 380

Page 380

Wouldn't all this lead to the paradox that there are no difficult problems in mathematics, since if anything is difficult it isn't a problem? What follows is, that the "difficult mathematical problems", i.e. the problems for mathematical research, aren't in the same relationship to the problem " $25 \times 25 = ?$ " as a feat of acrobatics is to a simple somersault. They aren't related, that is, just as very easy to very difficult; they are 'problems' in different meanings of the word.

Page 380

"You say 'where there is a question, there is also a way to answer it', but in mathematics there are questions that we do not see any way to answer." Quite right, and all that follows from that is that in this case we are not using the word 'question' in the same sense as above. And perhaps I should have said "here there are two different forms and I want to use the word 'question' only for the first". But this latter point is a side-issue. What is important is that we are here concerned with two different forms. (And if you want to say they are just two different *kinds* of question you do not know your way about the grammar of the word "kind".)

Page 380

"I know that there is a solution for this problem, although I don't yet know what kind of solution"†1--In what symbolism do you know it?

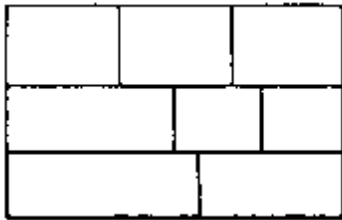

Page 380

"I know that here there must be a law." Is this knowledge an amorphous feeling accompanying the utterance of the sentence?

Page Break 381

Page 381

That does not interest us. And if it is a symbolic process--well, then the problem is to represent it in a visible symbolism.

Page 381

What does it mean to *believe* Goldbach's theorem? What does this belief consist in? In a feeling of certainty as we state or hear the theorem? That does not interest us. I don't even know how far this feeling may be caused by the proposition itself. How does the belief connect with this proposition? Let us look and see what are the consequences of this belief, where it takes us. "It makes me search for a proof of the proposition."--Very well; and now let us look and see what your searching really consists in. Then we shall know what belief in the proposition amounts to.

Page 381

We may not overlook a difference between forms--as we may overlook a difference between suits, if it is very slight.

Page 381

For us--that is, in grammar--there are in a certain sense no 'fine distinctions'. And altogether the word distinction doesn't mean at all the same as it does when it is a question of a distinction between two things.

Page 381

A philosopher feels changes in the style of a derivation which a contemporary mathematician passes over calmly with a blank face. What will distinguish the mathematicians of the future from those of today will really be a greater sensitivity, and *that* will--as it were--prune mathematics; since people will then be more intent on absolute clarity than on the discovery of new games.

Page 381

Philosophical clarity will have the same effect on the growth of mathematics as sunlight has on the growth of potato shoots. (In a dark cellar they grow yards long.)

Page 381

A mathematician is bound to be horrified by my mathematical comments, since he has always been trained to avoid indulging in

Page Break 382

thoughts and doubts of the kind I develop. He has learned to regard them as something contemptible and, to use an analogy from psycho-analysis (this paragraph is reminiscent of Freud), he has acquired a revulsion from them as infantile. That is to say, I trot out all the problems that a child learning arithmetic, etc., finds difficult, the problems that education represses without solving. I say to those repressed doubts: you are quite correct, go on asking, demand clarification!

Page Break 383

26

Euler's proof

Page 383

From the inequality

$$1 + 1/2 + 1/3 + 1/4 + \dots \neq (1 + 1/2 + 1/2^2 + 1/2^3 + \dots)(1 + 1/3 + 1/3^2 + \dots)$$

can we derive a number which is still missing from the combinations on the right hand side? Euler's proof that there are infinitely many prime numbers is meant to be an existence proof, but how is such a proof possible without a construction?

$$\sim 1 + 1/2 + 1/3 + \dots = (1 + 1/2 + 1/2^2 + \dots)(1 + 1/3 + 1/3^2 + \dots)$$

The argument goes like this: The product on the right is a series of fractions $1/n$ in whose denominators all multiples of the form $2^v 3^u$ occur; if there were no numbers besides these, then this series would necessarily be the same as the series $1 + 1/2 + 1/3 + \dots$ and in that case the sums also would necessarily be the same. But the left hand side is ∞ and the right hand side only a finite number $2/1 \cdot 3/2 = 3$, so there are infinitely many fractions missing in the right-hand series, that is, *there are* on the left hand side fractions that do not occur on the right. †1 And now the question is: is this argument correct? If it were a question of finite series, everything would be perspicuous. For then the method of summation would enable us to find out which terms occurring in the left hand series were missing from the right hand series. Now we might ask: how does it come about that the left hand series gives ∞ ? What must it contain in addition to the terms on the right to make it infinite? Indeed the question arises: does an equation, like $1 + 1/2 + 1/3 + \dots = 3$ above have any sense at all? I certainly can't find out from it *which* are the extra terms on the left. How do we know that all the terms on the right hand side also occur on the left? In the case of finite series I can't say that until I have ascertained it term by term;--and if I do so I see at the same time which are the extra ones.--Here there is no connection between the result of the sum and the terms, and only such a connection could furnish a proof. Everything becomes clearest if we imagine the business done with a finite equation:

Page Break 384

$$1 + 1/2 + 1/3 + 1/4 + 1/5 + 1/6 \neq (1 + 1/2)(1 + 1/3) = 1 + 1/2 + 1/3 + 1/6$$

Here again we have that remarkable phenomenon that we might call proof by circumstantial evidence in mathematics--something that is absolutely never permitted. It might also be called a proof by *symptoms*. The result of the summation is (or is regarded as) a symptom that there are terms on the left that are missing on the right. The connection between the symptom and what we would like to have proved is a *loose* connection. That is, no bridge has been built, but we rest content with *seeing* the other bank.

Page 384

All the terms on the right hand side occur on the left, but the sum on the left hand side is ∞ and the sum of the right hand side is only a finite number, *so there must...* but in mathematics nothing *must be* except what *is*.

Page 384

The bridge has to be built.

Page 384

In mathematics there are no symptoms: it is only in a psychological sense that there can be symptoms for mathematicians.

Page 384

We might also put it like this: in mathematics nothing can be inferred unless it can be *seen*.

Page 384

That reasoning with all its looseness no doubt rests on the confusion between a sum and the limiting value of a sum.

Page 384

We do see dearly that *however far* we continue the right-hand series we can always continue the left hand one far enough to contain all the terms of the right hand one. (And that leaves it *open* whether it then contains other terms as well).

Page 384

We might also put the question thus: if you had only this proof, what would you bet on it? If we discovered the primes up to N , could we later go on for ever looking for a further prime number--since the proof guarantees that we will find one?--Surely that is nonsense. For "if we only search long enough" has no meaning. (That goes for existence proofs in general).

Page 384

Could I add further prime numbers to the left hand side in this proof? Certainly not, because I don't know how to discover any, and that means that I have no concept of prime number; the proof

Page Break 385

hasn't given me one. I could only add arbitrary numbers (or series).

(Mathematics is dressed up in false interpretations).

("Such a number *has to* turn up" has no meaning in mathematics. That is closely connected with the fact that "in logic nothing is more general or more particular than anything else").

If the numbers were all multiples of 2 and 3 then

$$\left(\lim_{n \rightarrow \infty} \sum_{v=0}^v \frac{1}{2^v} \right) \cdot \left(\lim_{n \rightarrow \infty} \sum_{v=0}^v \frac{1}{3^v} \right) \text{ would have to yield } \lim_{n \rightarrow \infty} \sum_{n=1}^n \frac{1}{n}$$

but it does not... What follows from that? (The law excluded middle). Nothing follows, except that the limiting values of the sums are different; that is, nothing. But now we might investigate how this comes about. And in so doing we may hit on numbers that are not representable as $2^v \cdot 3^\mu$. Thus we shall hit on larger prime numbers, but we will never see that *no* number of such original numbers will suffice for the formulation of all numbers.

$$1 + 1/2 + 1/3 + \dots \neq 1 + 1/2 + 1/2^2 + 1/2^3$$

However many terms of the form $1/2^v$ I take they never add up to more than 2, whereas the first four terms of the left-hand series already add up to more than 2. (So *this* must already contain the proof.) This also gives us at the same time the construction of a number that is not a power of 2, for the rule now says: find a segment of the series that adds up to more than 2: this must contain a number that is not a power of 2.

$$(1 + 1/2 + 1/2^2 + \dots) \cdot (1 + 1/3 + 1/3^3 + \dots) \dots (1 + 1/n + 1/n^2 \dots) = n$$

If I extend the sum $1 + 1/2 + 1/3 + \dots$ until it is greater than n , this part must contain a term that doesn't occur in the right hand series, for if the right hand series contained all those terms it would yield a larger and not a smaller sum.

The condition for a segment of the series $1 + 1/2 + 1/3 + \dots$ say $1/n + 1/(n+1) + 1/(n+2) + \dots + 1/(n+v)$ being equal to or greater than 1 is as follows.

To make:

$$1/n + 1/(n+1) + 1/(n+2) + \dots + 1/(n+v) \stackrel{!}{\geq} 1.$$

transform the left hand side into:

$$\begin{aligned}
& 1 + \frac{n}{n+1} + \frac{n}{n+2} + \dots + \frac{n}{n+v} = \\
& \frac{1 + \left(1 - \frac{1}{n+1}\right) + \left(1 - \frac{2}{n+2}\right) + \dots + \left(1 - \frac{n-1}{n+(n-1)}\right) + \frac{n}{2n}}{n} + \\
& \frac{\frac{n}{2n+1} + \frac{n}{2n+2} + \dots + \frac{n}{n+v}}{n} = \\
& = \frac{n - \frac{1}{2}n(n-1) \frac{1}{n+1} + (v-n+1) \frac{n}{n+v}}{n} = 1 - \frac{n-1}{2n+2} + \\
& \frac{v-n+1}{n+v} \approx 1 \\
& \therefore 2nv + 2v - 2n^2 - 2n + 2n + 2 - n^2 - nv + n + v \approx 0 \\
& nv + 3v - 3n^2 + 2 + n \approx 0 \\
& v \approx \frac{3n^2 - (n+2)}{n+3} < 3n - 1
\end{aligned}$$

Page Break 387

The trisection of an angle, etc.

Page 387

We might say: in Euclidean plane geometry we can't look for the trisection of an angle, because there is no such thing, and we can't look for the bisection of an angle, because there is such a thing.

Page 387

In the world of Euclid's Elements I can no more ask for the trisection of an angle than I can search for it. It just isn't mentioned.

Page 387

(I can locate the problem of the trisection of an angle within a larger system but can't ask within the system of Euclidean geometry whether it's soluble. In what *language* should I ask this? In the Euclidean?--But neither can I ask in Euclidean language about the possibility of bisecting an angle within the Euclidean system. For in that language that would boil down to a question about absolute possibility, which is always nonsense.)

Page 387

Incidentally, here we must make a distinction between different sorts of question, a distinction which will show once again that what we call a "question" in mathematics is not the same as what we call by that name in everyday life. We must distinguish between the question "how does one divide an angle into two equal parts?" and the question "is *this* construction the bisection of an angle?" A question makes sense only in a calculus which gives us a method for its solution; and a calculus may well give us a method for answering the one question without giving us a method for answering the other. For instance, Euclid doesn't shew us how to look for the solutions to his problems; he gives them to us and then proves that they are solutions. And this isn't a psychological or pedagogical matter, but a mathematical one. That is, the *calculus* (the one he gives us) doesn't enable us to look for the construction. A calculus which does enable us to do that is a *different* one.

Page Break 388

(Compare methods of integration with methods of differentiation, etc.)

Page 388

In mathematics there are very different things that all get called proofs, and the differences between them are *logical* differences. The things called 'proofs' have no more internal connection with each other than the things called '*numbers*'.

What kind of *proposition* is "It is impossible to trisect an angle with ruler and compass"? The same kind, no doubt, as "There is no $F(3)$ in the series of angle-divisions $F(n)$, just as there is no 4 in the series of combination-numbers $[n.(n - 1)]/2$ ". But what kind of proposition is *that*? The same kind as "there is no $\frac{1}{2}$ in the series of cardinal numbers". That is obviously a (superfluous) rule of the game, something like: in draughts there is no piece that is called "the queen". The question whether trisection is possible is then the question whether there is such a thing in the game as trisection, whether there is a piece in draughts called "the queen" that has some kind of a role like that of the queen in chess. Of course this question could be answered simply by a stipulation; but it wouldn't set any problem or task of calculation, and so it wouldn't have the same sense as a question whose answer was: I will work out whether there is such a thing. (Something like: I will work out whether any of the numbers 5, 7, 18, 25 is divisible by 3). Now is the question about the possibility of trisecting an angle that sort of question? It is if you have a general system in the calculus for calculating the possibility of division into n equal parts.

Now why does one call *this* proof the proof of *this* proposition? A proposition isn't a name; as a proposition it belongs to a system of language. If I can say "there is no such thing as trisection" then it makes sense to say "there is no such thing as quadrisection", etc., etc. And if *this* is a proof of the first proposition (a part of its syntax), then there must be corresponding proofs (or disproofs) for the other propositions of the proposition-system, otherwise they don't belong to the same system.

I can't ask whether 4 occurs among the combination-numbers

if that is my number-system. And I can't ask whether $\frac{1}{2}$ occurs in the cardinal numbers, or show that it isn't one of them, unless by "cardinal numbers" I mean part of a system that contains $\frac{1}{2}$ as well. (Equally I can't either say or prove that 3 is one of the cardinal numbers.) The question really means something like this: "If you divide $\frac{1}{2}$ do you get whole numbers?", and that can only be asked in a system in which divisibility and indivisibility is familiar. (The *working out* must make sense.)

If we don't mean by "cardinal numbers" a subset of the rational numbers, then we can't work out whether $\frac{81}{3}$ is a cardinal number, but only whether the division $\frac{81}{3}$ comes out or not.

Instead of the problem of trisecting an angle with straightedge and compass we might investigate a parallel, and much more perspicuous problem. There is nothing to prevent us restricting the possibilities of construction with straightedge and compass still further. We might for instance lay down the condition that the angle of the compass may not be changed. And we might lay down that the only construction we know--or better: that our calculus knows--is the one used to bisect a line AB, namely

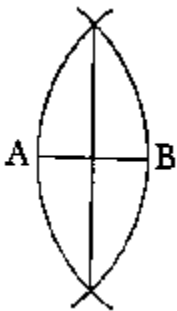

(That might actually be the primitive geometry of a tribe. I said above that the number series "1, 2, 3, 4, 5, many" has equal rights with the series of cardinal numbers†1 and that would go for this geometry too. In general it is a good dodge in our investigations to imagine the arithmetic or geometry of a primitive people.)

I will call this geometry the system α and ask: "in the system α is it possible to trisect a line?"

What kind of trisection is meant in this question?--that's obviously what the sense of the question depends on. For instance, is what is meant physical trisection--trisection, that is, by trial and error and measurement? In that case the answer is perhaps yes. Or optical trisection--trisection, that is, which yields three parts which look the same

length? It is quite easily imaginable that the parts a, b, and c might look the same length if, for instance, we were looking through some distorting medium.

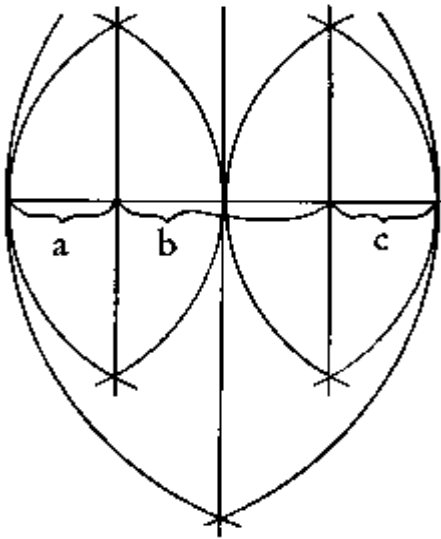

Page 390

We might represent the results of division in the system α by the numbers $2, 2^2, 2^3$, etc. in accordance with the number of the segments produced; and the question whether trisection is possible might mean: does any of the numbers in this series = 3? Of course that question can only be asked if $2, 2^2, 2^3$, etc. are imbedded in another system (say the cardinal number system); it can't be asked if these numbers are themselves our number system for in that case we, or our system, are not acquainted with the number 3. But if our question is: is one of the numbers $2, 2^2$, etc. equal to 3, then here nothing is really said about a *trisection* of the line. None the less, we might look in this manner at the question about the possibility of trisection.--We get a different view, if we adjoin to the system α a system in which lines are divided in the manner of this figure:

Page Break 391

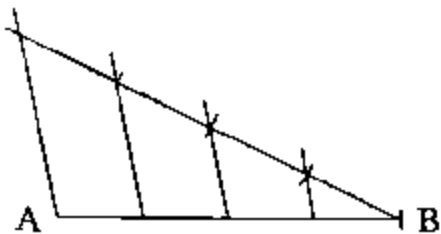

Page 391

It can then be asked: is a division into 180 sections a division of type α ? And this question might again boil down to: is 108 a power of 2? But it might also indicate a different decision procedure (have a different sense) if we connected the systems α and β to a system of geometrical constructions in such a way that it could be proved in the system that the two constructions "must yield" the same division points B, C, D.

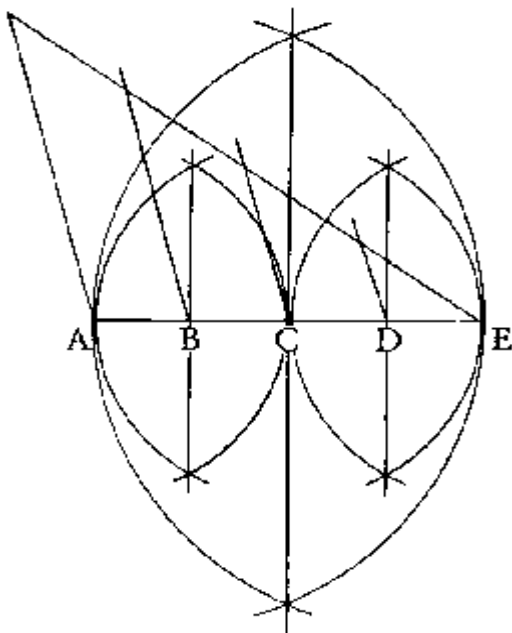

Page 391

Suppose that someone, having divided a line AB into 8 sections in the system α , groups these into the lines a, b, c, and asks: is that a trisection into 3 equal sections? (We could make the case more easily imaginable if we took a larger number of original sections,

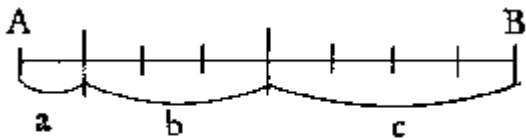

Page Break 392

which would make it possible to form groups of sections which looked the same length). The answer to that question would be a proof that 2^3 is not divisible by 3; or an indication that the sections are in the ratio 1:3:4. And now you might ask: but surely I do have a concept of trisection in the system, a concept of a division which yields the parts a, b, c, in the ratio 1:1:1? Certainly, I have now introduced a new concept of 'trisection of a line'; we might well say that by dividing the line AB into eight parts we have divided the line CB into 3 equal parts, if that is just *to mean* we have produced a line that consists of 3 equal parts.



Page 392

The perplexity in which we found ourselves in relation to the problem of trisection was roughly this: if the trisection of an angle is impossible--logically impossible--how can we ask questions about it at all? How can we describe what is logically impossible and significantly raise the question of its possibility? That is, how can one put together *logically* ill-assorted concepts (in violation of grammar, and therefore nonsensically) and significantly ask about the possibility of the combination?--But the same paradox would arise if we asked "is $25 \times 25 = 620$?"; for after all it's *logically* impossible that that equation should be correct; I certainly can't describe what it would be like if...--Well, a doubt whether $25 \times 25 = 620$ (or whether it = 625) has no more and no less sense than the method of checking gives it. It is quite correct that we don't here imagine, or describe, what it is like for 25×25 to be 620; what that means is that we are dealing with a type of question that is (logically) different from "is this street 620 or 625 metres long"?

Page 392

(We talk about a "division of a circle into 7 segments" and also of a division of a cake into 7 segments).

Page Break 393

Page 393

If you say to someone who has never tried "try to move your ears", he will first move some part of his body near his ears that he has moved before, and either his ears will move at once or they won't. You might say of this process: he is trying to move his ears. But if it can be called trying, it isn't trying in at all the same sense as trying to move your ears (or your hands) in a case where you already "know how to do it" but someone is holding them so that you can move them only with difficulty or not at all. It is the first sense of trying that corresponds to trying "to solve a mathematical problem" when there is no method for its solution. One can always ponder on the apparent problem. If someone says to me "try by sheer will power to move that jug at the other end of the room" I will look at it and perhaps make some strange movements with my face muscles; so that even in that case there seems to be such a thing as trying.

Page 393

Think of what it means to *search for* something in one's memory. Here there is certainly *something like* a search in the strict sense.

Page 393

But trying to produce a phenomenon is not the same as *searching* for it.

Page 393

Suppose I am feeling for a painful place with my hand. I am searching in touch-space not in pain-space. That means: what I find, if I find it, is really a place and not the pain. That means that even if experience shows that pressing produces a pain, pressing isn't searching for a pain, any more than turning the handle of a generator is searching for a spark.

Page Break 394

Page 394

Can one try to beat the wrong time to a melody? How does such an attempt compare with trying to lift a weight that is too heavy?

Page 394

It is highly significant that one can see the group |||| in different ways (in different groupings); but what is still more noteworthy is that one can do it at will. That is, that there is a quite definite process of producing a particular "view" at will; and correspondingly a quite definite process of unsuccessfully attempting to do so. Similarly, you can to order see the figure below in such a way that first one and then the other vertical line is the nose, and first one and then the other line becomes the mouth; in certain circumstances you can try in vain to do the one or the other.



Page 394

The essential thing here is that this attempt is the same kind of thing as trying to lift a weight with the hand; is isn't like the sort of trying where one does different things, tries out different means, in order (e.g.) to lift a weight. In the two cases the word "attempt" has quite different meanings. (An extremely significant grammatical fact.)

Page Break 395

VI INDUCTIVE PROOFS AND PERIODICITY

29

How far is a proof by induction a proof of a proposition?

Page 395

If a proof by induction is a proof of $a + (b + c) = (a + b) + c$, we must be able to say: *the calculation gives the result* that $a + (b + c) = (a + b) + c$ (and no other result).

Page 395

In that case the general method of calculating it must already be known, and we must be able to work out $a + (b + c)$ straight off in the way we can work out 25×16 . So first there is a general rule taught for working out all such problems, and later the particular cases are worked out.--But what is the general method of working out here? It must be based on general rules for signs (--say, the associative law--).

Page 395

If I negate $a + (b + c) = (a + b) + c$ it only makes sense if I mean to say something like: $a + (b + c)$ isn't $(a + b) + c$, but $(a + 2b) + c$. For the question is: In what space do I negate the proposition? If I mark it off and exclude it, what do I exclude it from?

Page 395

To check $25 \times 25 = 625$ I work out 25×25 until I get the right hand side;--can I work out $a + (b + c) = (a + b) + c$, and get the result $(a + b) + c$? Whether it is provable or not depends on whether we treat it as calculable or not. For if the proposition is a rule, a paradigm, which every calculation has to follow, then it makes no more sense to talk of working out the equation, than to talk of working out a definition.

Page 395

What makes the calculation possible is the system to which the proposition belongs; and that also determines what miscalculations can be made in the working out. E.g. $(a + b)^2$ is $a^2 + 2ab + b^2$ and not $a^2 + ab + b^2$; but $(a + b)^2 = -4$ is not a possible miscalculation in this system.

Page Break 396

Page 396

I might also say very roughly (see other remarks): " $25 \times 64 = 160, 64 \times 25 = 160$; that proves that $a \times b = b \times a$ " (this way of speaking need not be absurd or incorrect; you only have to interpret it correctly). The conclusion can be correctly drawn from that; so in *one* sense " $a.b = b.a$ " can be proved.

Page 396

And I want to say: It is *only* in the sense in which you can call working out such an example a proof of the algebraic proposition that the proof by induction is a proof of the proposition. Only to that extent is it a check of the algebraic proposition. (It is a check of its structure, not its generality).

Page 396

(Philosophy does not examine the calculi of mathematics, but only what mathematicians say about these calculi.)

Page Break 397

Recursive proof and the concept of proposition. Is the proof a proof that a proposition is true and its contradictory false?

Page 397

Is the recursive proof of

$$a + (b + c) = (a + b) + c \dots A$$

an answer to a question? If so, what question? Is it a proof that an assertion is true and its contradictory false?

Page 397

What Skolem†1 calls a recursive proof of A can be written thus;

$$\left. \begin{aligned} \mathbf{a} + (\mathbf{b} + \mathbf{1}) &= (\mathbf{a} + \mathbf{b}) + \mathbf{1} \\ \mathbf{a} + (\mathbf{b} + (\mathbf{c} + \mathbf{1})) &= \mathbf{a} + ((\mathbf{b} + \mathbf{c}) + \mathbf{1}) = (\mathbf{a} + (\mathbf{b} + \mathbf{c})) + \mathbf{1} \\ (\mathbf{a} + \mathbf{b}) + (\mathbf{c} + \mathbf{1}) &= ((\mathbf{a} + \mathbf{b}) + \mathbf{c}) + \mathbf{1} \end{aligned} \right\} \mathbf{B}$$

Page 397

In this proof the proposition proved obviously doesn't occur at all.--What we have to do is to make a general stipulation permitting the step to it. This stipulation could be expressed thus

$$\left. \begin{aligned} \alpha \quad \varphi(\mathbf{1}) &= \psi(\mathbf{1}) \\ \beta \quad \varphi(\mathbf{c} + \mathbf{1}) &= F(\varphi(\mathbf{c})) \\ \gamma \quad \psi(\mathbf{c} + \mathbf{1}) &= F(\psi(\mathbf{c})) \end{aligned} \right\} \Delta \quad \varphi(\mathbf{c}) = \psi(\mathbf{c})$$

Page 397

If three equations of the form α, β, γ are proved, we say "the equation Δ is proved for all cardinal numbers". This is a definition of this latter form of expression in terms of the first. It shows that we aren't using the word "prove" in the second case in the same way as in the first. In any case it is misleading to say that we have proved the equation Δ or A. Perhaps it is better to say that we have proved its generality, though that too is misleading in other respects.

Page 397

Now has the proof B answered a question, or proved an assertion true? And which is the proof B? Is it the

group of three equations of the form α, β, γ or the class of proofs of these equations? These equations do *assert* something (they don't prove anything in the sense in which *they* are proved). But the proofs

Page Break 398

of α, β, γ answer the question whether these three equations are correct and prove true the assertion that they are correct. All I can do is to explain: the question whether A holds for all cardinal numbers is to mean: "for the functions

$$\phi(\xi) = a + (b + \xi), \psi(\xi) = (a + b) + \xi$$

are the equations α, β, γ valid?" And then that question is answered by the recursive proof of A, if what that means is the proofs of α, β, γ (or the laying down of α and the use of it to prove β and γ).

Page 398

So I can say that the recursive proof shows that the equation A satisfies a certain condition; but it isn't the kind of condition that the equation $(a + b)^2 = a^2 + 2ab + b^2$ has to fulfil in order to be called "correct". If I call A "correct" because equations of the form α, β, γ can be proved for it, I am no longer using the word "correct" in the same way as in the case of the equations α, β, γ or $(a + b)^2 = a^2 + 2ab + b^2$.

Page 398

$$\frac{1}{3} = 0.\underline{3}$$

What does " $\frac{1}{3} = 0.\underline{3}$ " mean? Does it mean the same as " $\frac{1}{3} = 0.\underline{3}$ "?--Or is that division the proof of the first proposition? That is, does it have the same relationship to it as a calculation has to what is proved?

" $\frac{1}{3} = 0.\underline{3}$ " is not the same kind of thing as

$$\frac{1}{2} = 0.5$$

what " $\frac{1}{2} = 0.5$ " corresponds to is " $\frac{1}{3} = 0.\underline{3}$ " not

$$\frac{1}{3} = 0.\underline{3}$$

" $\frac{1}{3} = 0.\underline{3}$ "

Page 398

Instead of the notation " $\frac{1}{4} = 0.25$ " I will adopt for this occasion the following " $\frac{1}{4} = 0.\underline{25}$ " So, for

example, " $\frac{3}{8} = 0.\underline{375}$ ". Then I can say, what corresponds to this proposition is not

Page Break 399

$\frac{1}{3} = 0.\underline{3}$, but e.g. " $\frac{1}{3} = 0.\underline{333}$ " is not a result of division (quotient) in the same sense as 0.375 . For we were acquainted with the numeral " 0.375 " before the division $\frac{3}{8}$; but what does " $0.\underline{3}$ " mean when detached from the periodic division?--The assertion that the division $a:b$ gives $0.\underline{c}$ as quotient is the same as the assertion that the first place of the quotient is c and the first remainder is the same as the dividend.

Page 399

The relation of B to the assertion that A holds for all cardinal numbers is the same as that of

$$\frac{1}{3} = 0.\underline{3} \text{ to } \frac{1}{3} = 0.\underline{3}$$

Page 399

The contradictory of the assertion "A holds for all cardinal numbers" is: one of the equations α, β, γ is false. And the corresponding question isn't asking for a decision between $\forall x.f(x)$ and $\exists x.\sim f(x)$.

Page 399

The construction of the induction is not a proof, but a certain arrangement of proofs (a pattern in the sense of an ornament). And one can't exactly say either: if I prove three equations, then I prove one. Just as the movements of a suite don't amount to a single movement.

Page 399

We can also say: we have a rule for constructing, in a certain game, decimal fractions consisting only of 3's; but if you regard *this rule* as a kind of number, it can't be the result of a division; the only result would be what we

$$a/d = c$$

may call periodic division which has the form a .

Page Break 400

31

Induction. (x).φx and (∃x).φx. Does the induction prove the general proposition true and an existential proposition false?

Page 400

$$3 \times 2 = 5 + 1$$

$$3 \times (a + 1) = 3 + (3 \times a) = (5 + b) + 3 = 5 + (b + 3)$$

Page 400

Why do you call this induction the proof that $(n):n > 2 \supset 3 \times n \neq 5$? Well, don't you see that if the proposition holds for $n = 2$, it also holds for $n = 3$, and then also for $n = 4$, and that it goes on like that for ever? (What am I explaining when I explain the way a proof by induction works?) So you call it a proof of $f(2).f(3).f(4)$, etc." but isn't it rather the form of the proofs of "f(2)" and "f(3)" and "f(4)", etc.? Or does that come *to the same thing*? Well, if I call the induction the proof of *one* proposition, I can do so only if that is supposed to mean no more than that it proves every proposition of a certain form. (And my expression relies on the analogy with the relationship between the proposition "all acids turn litmus paper red" and the proposition "sulphuric acid turns litmus paper red").

Page 400

Suppose someone says "let us check whether $f(n)$ holds for all n " and begins to write the series

$$3 \times 2 = 5 + 1$$

$$3 \times (2 + 1) = (3 \times 2) + 3 = (5 + 1) + 3 = 5 + (1 + 3)$$

$$3 \times (2 + 2) = (3 \times (2 + 1)) + 3 = (5 + (1 + 3)) + 3 = 5 + ((1 + 3) + 3)$$

and then he breaks off and says "I see it holds for all n "--So he has seen an *induction*! But was he *looking for* an induction? He didn't have any method for looking for one. And if he hadn't discovered one, would he *ipso facto* have found a number which does not satisfy the condition?--The rule for checking can't be: let's see whether there is an induction or a case for which the law does not hold.--If the law of excluded middle doesn't hold, that can only mean that our expression isn't comparable to a proposition.

Page 400

When we say that the induction proves the general proposition, we think: it proves that this proposition and not its contradictory

Page Break 401

is true. But what would be the contradictory of the proposition proved? Well, that $(\exists n).\sim f(n)$ is the case. Here we combine two concepts: one derived from my current concept of the proof of $(n).f(n)$, and another taken from the analogy with $(\exists x).\phi x$. (Of course we have to remember that " $(n). f(n)$ " isn't a proposition until I have a criterion for its truth; and then it only has the sense that the criterion gives it. Although, before getting the criterion, I could look out for something like an analogy to $(x).fx \dagger 1$). What is the opposite of what the induction proves? The proof of $(a + b)^2 = a^2 + 2ab + b^2$ works out this equation in contrast to something like $(a + b)^2 = a^2 + 3ab + b^2$. What does the inductive proof work out? The equations: $3 \times 2 = 5 + 1$, $3 \times (a + 1) = (3 \times a) + 3$, $(5 + b) + 3 = 5 + (b + 3)$ as opposed to things like $3 \times 2 = 5 + 6$, $3 \times (a + 1) = (4 \times a) + 2$, etc. But this opposite does not correspond to the proposition $(\exists x).\phi x$ --Further, what does conflict with the induction is every proposition of the form $\sim f(n)$, i.e. the propositions " $\sim f(2)$ ", " $\sim f(3)$ ", etc.; that is to say, the induction is *the common element* in the working out of $f(2)$, $f(3)$, etc.; but it isn't the working out of "all propositions of the form $f(n)$ ", since of course no class of propositions occurs in the proof that I call "all propositions of the form $f(n)$ ". Each one of these calculations is a checking of a proposition of the form $f(n)$. I was able to investigate the correctness of this proposition and employ a method to check it; all the induction did was to bring this into a simple form. But if I call the induction "the proof of a general proposition", I can't ask whether that proposition is correct (any more than whether the form of the cardinal numbers is correct). Because the things I call inductive proofs give me no method of *checking* whether the general proposition is correct or incorrect; instead, the method has to show me how to work out (check) whether or not an induction can be constructed for a particular case within a system of propositions. (If I may so put it, what is checked in this way is whether all n have this or that property; not whether all of them have it, or whether there are some that don't have it.

For example, we work

Page Break 402

out that the equation $x^2 + 3x + 1 = 0$ has no rational roots (that there is no rational number that...), and the equation $x^2 + 2x + \frac{1}{2} = 0$ has none, but the equation $x^2 + 2x + 1 = 0$ does, etc.)

Page 402

Hence we find it odd if we are told that the induction is a proof of the general proposition; for we feel rightly that in the language of the induction we couldn't have posed the general question at all. It wasn't that we began with an alternative between which we had to decide. (We only seemed to, so long as we had in mind a calculus with finite classes).

Page 402

Prior to the proof asking about the general proposition made no sense at all, and so wasn't even a question, because the question would only have made sense if a general method of decision had been known *before* the particular proof was discovered.

Page 402

The proof by induction isn't something that settles a disputed question.

Page 402

If you say: "the proposition '(n).fn' follows from the induction" only means that every proposition of the form f(n) follows from the induction and "the proposition $(\exists n).\sim fn$ contradicts the induction" only means "every proposition of the form $\sim f(n)$ is disproved by the induction", then we may agree; but we shall ask: what is the correct way for us to use the expression "the proposition (n).f(n)"? What is its grammar? (For from the fact that I use it in certain contexts it doesn't follow that I use it everywhere in the same way as the expression "the proposition (x). ϕx .")

Page 402

Suppose that people argued whether the quotient of the division $1/3$ must contain only threes, but had no

$$1.0/3$$

method of deciding it. Suppose one of them noticed the inductive property of $1/3 = 0.3$ and said: now I know that there must be only threes in the quotient. The others had not thought of *that* kind of decision. I suppose that they had vaguely imagined some kind of decision by checking each step, though of course they could never have reached a decision in this way. If they hold on to their extensional

Page Break 403

viewpoint, the induction does produce a decision because in the case of each extension of the quotient it shows that it consists of nothing but threes. But if they drop their extensional viewpoint the induction decides nothing, or

$$1.0/3$$

nothing that is not decided by working out $1/3 = 0 \cdot 3$, namely that the remainder is the same as the dividend. But nothing else. Certainly, there is a valid question that may arise, namely, is the remainder left after this division the same as the dividend? This question now takes the place of the old extensional question, and of course I can keep the old wording, but it is now extremely misleading since it always makes it look as if having the induction were only a vehicle--a vehicle that can take us into infinity. (This is also connected with the fact that the sign "etc." refers to an internal property of the bit of the series that precedes it, and not to its extension.)

Page 403

Of course the question "is there a rational number that is a root of $x^2 + 3x + 1 = 0$?" is decided by an induction; but in this case I have actually constructed a method of forming inductions; and the question is only so phrased because it is a matter of constructing inductions. That is, a question is settled by an induction, if I can look for the induction in advance; if everything in its sign is settled in advance bar my acceptance or rejection of it in such a way that I can decide yes or no by calculating; as I can decide, for instance, whether in $5/7$ the remainder is equal to the dividend or not. (The employment in these cases of the expressions "all..." and "there is..." has a certain similarity with the employment of the word "infinite" in the sentence "today I bought a straightedge with an infinite radius of curvature").

Page 403

$$1/3$$

The periodicity of $1/3$ decides nothing that had been left open. Suppose someone had been looking in vain, before the discovery of the periodicity, for a 4 in the development of $1/3$, he

still couldn't significantly have put the question "is there a 4 in the development of 1/3?". That is, *independently of* the fact that he didn't actually discover any 4s, we can convince him that he doesn't have a method of deciding his question. Or we might say: quite apart from the result of his activity we could instruct him about the grammar of his question and the nature of his search (as we might instruct a contemporary mathematician about analogous problems). "But as a result of discovering the periodicity he does stop looking for a 4! So it does convince him that he will never find one."--No. The discovery of the periodicity will cure him of looking *if* he makes the appropriate adjustment. We might ask him: "Well, how about it, do you still want to look for a 4?" (Or has the periodicity so to say, changed your mind?)

The discovery of the periodicity is really the construction of a new symbol and a new calculus. For it is misleading to say that it consists in our having *realised* that the first remainder is the same as the dividend. For if we had asked someone unacquainted with periodic division whether the first remainder in this division was the same as the dividend, of course he would have answered "yes"; and so he did realise. But that doesn't mean he must have

$$a/b = c$$

realised the periodicity; that is, it wouldn't mean he had discovered the calculus with the sign **a** .

Isn't what I am saying what Kant meant, by saying that $5 + 7 = 12$ is not analytic but synthetic *a priori*?

Is there a further step from writing the recursive proof to the generalization? Doesn't the recursion schema already say all that is to be said?

We commonly say that the recursive proofs show that the algebraic equations hold for all cardinal numbers; for the time being it doesn't matter whether this expression is well or ill chosen, the point is whether it has the same clearly defined meaning in all cases.

And isn't it clear that the recursive proofs in fact show *the same* for all "proved" equations?

And doesn't that mean that between the recursive proof and the proposition it proves there is always the same (internal) relation?

Anyway it is quite clear that there must be a recursive, or better, iterative "proof" of this kind (A proof conveying the insight that "that's the way it must be with all the numbers".)

I.e. it seems clear *to me*; and it seems that by a process of iteration I could make the correctness of these theorems for the cardinal numbers intelligible to someone else.

But how do I know that $28 + (45 + 17) = (28 + 45) + 17$ without having proved it? How can a general proof give me a particular proof? I might after all go through the particular proof, and how would the two proofs meet in it? What happens if they do not agree?

In other words: suppose I wanted to show someone that the associative law is really part of the nature of number, and isn't something that only accidentally holds in this particular case; wouldn't I use a process of iteration to try to show that the law holds and must go on holding? Well--that shows us what we mean here by saying that a law must hold for all numbers.

And what is to prevent us calling this process a proof of the law?

This concept of "making something comprehensible" is a boon in a case like this.

For we might say: the criterion of whether something is a proof of a proposition is whether it could be used for making it comprehensible. (Of course here again all that is involved is an extension of our grammatical

investigation of the word "proof" and not any psychological interest in the process of making things comprehensible.)

Page 406

"This proposition is proved for all numbers by the recursive procedure." That is the expression that is so very misleading. It sounds as if here a proposition saying that such and such holds for all cardinal numbers is proved true by a particular route, and as if this route was a route through a space of conceivable routes.

Page 406

But really the recursion shows nothing but itself, just as periodicity too shows nothing but itself.

Page 406

We are not saying that when $f(1)$ holds and when $f(c + 1)$ follows from $f(c)$, the proposition $f(x)$ is *therefore* true of all cardinal numbers; but: "the proposition $f(x)$ holds for all cardinal numbers" *means* "it holds for $x = 1$, and $f(c + 1)$ follows from $f(c)$ ".

Page 406

Here the connection with generality in finite domains is quite clear, for in a finite domain that would certainly be a proof that $f(x)$ holds for all values of x , and *that* is the reason why we say in the arithmetical case that $f(x)$ holds for all numbers.

Page 406

At least I have to say that any objection that holds against the proof $B \dagger 1$ holds also e.g. against the formula $(a + b)^n = \text{etc.}$

Page 406

Here too, I would have to say, I am merely assuming an algebraic rule that agrees with the inductions of arithmetic.

Page Break 407

$$\begin{aligned} f(n) \times (a + b) &= f(n + 1) \\ f(1) &= a + b \\ \text{therefore } f(1) \times (a + b) &= (a + b)^2 = f(2) \\ \text{therefore } f(2) \times (a + b) &= (a + b)^3 = f(3), \text{ etc.} \end{aligned}$$

Page 407

So far all is clear. But then: "*therefore* $(a + b)^n = f(n)$ "!

Page 407

Is a further inference drawn here? Is there still something to be established?

Page 407

But if someone shows me the formula $(a + b)^n = f(n)$ I could ask: how have we got there? And the answer would be the group

$$\begin{aligned} f(n) \times (a + b) &= f(n + 1) \\ f(1) &= a + b \end{aligned}$$

So isn't it a proof of the algebraic proposition?--Or is it rather an answer to the question "what does the algebraic proposition mean?"

Page 407

I want to say: once you've got the induction, it's all over.

Page 407

The proposition that A holds for all cardinal numbers is really the complex B plus its proof, the proof of β and γ . But that shows that this proposition is not a proposition in the same sense as an equation, and this proof is not in the same sense a proof of a proposition.

Page 407

Don't forget that it isn't that we first of all have the concept of proposition, and then come to know that equations are mathematical propositions, and later realise that there are also other kinds of mathematical propositions.

Page Break 408

Page 408

(Editor's note: What follows between the square brackets we have taken from one of the manuscript books that Wittgenstein used for this chapter; although it is not in the typescript--"A" and "B" are given above, on p. 397.)

$$\begin{array}{l}
 \text{[(R)} \\
 \text{(I)} \\
 \left. \begin{array}{l}
 a + (b + (c + 1)) \stackrel{R}{=} a + ((b + c) + 1) = \\
 (a + b) + (c + 1) \stackrel{R}{=} ((a + b) + c) + 1
 \end{array} \right\} a + (b + c) = (a + b) + c \\
 \\
 \text{(II)} \\
 \left. \begin{array}{l}
 (a + 1) + 1 \stackrel{R}{=} (a + 1) + 1 \\
 1 + (a + 1) \stackrel{R}{=} (1 + a) + 1
 \end{array} \right\} a + 1 = 1 + a \\
 \\
 \text{(III)} \\
 \left. \begin{array}{l}
 a + (b + 1) \stackrel{R}{=} (a + b) + 1 \\
 (b + 1) + a \stackrel{R}{=} (b + (1 + a)) \stackrel{II}{=} b + (a + 1) \stackrel{R}{=} \\
 \qquad \qquad \qquad = (b + a) + 1
 \end{array} \right\} a + b = b + a \\
 \\
 \begin{array}{l}
 a \cdot 1 = a \dots \text{(D)} \\
 a \cdot (b + 1) = a \cdot b + a \text{(M)}
 \end{array} \\
 \\
 \text{(IV)} \\
 \left. \begin{array}{l}
 a \cdot (b + (c + 1)) \stackrel{R}{=} a \cdot ((b + c) + 1) \stackrel{M}{=} \\
 \qquad \qquad \qquad = a \cdot (b + c) + a \\
 a \cdot b + (a \cdot (c + 1)) \stackrel{M}{=} a \cdot b + (a \cdot c + a) \stackrel{D}{=} \\
 \qquad \qquad \qquad = (a \cdot b + a \cdot c) + a
 \end{array} \right\} a \cdot (b + c) = a \cdot b + a \cdot c
 \end{array}$$

Page 408

(A step by step investigation of this proof would be very instructive.) The first step in I, $a + (b + (c + 1)) = a + ((b + c) + 1)$, if it is made in accordance with R, shows that the variables in R are not meant in the same way as those in the equations of I; since R would otherwise allow only the replacement of $a + (b + 1)$ by $(a + b) + 1$, and not the replacement of $b + (c + 1)$ by $(b + c) + 1$.

Page Break 409

The same appears in the other steps in the proof.

Page 409

If I said that the proof of the two lines of the proof justifies me in inferring the rule $a + (b + c) = (a + b) + c$, that wouldn't mean anything, unless I had deduced that in accordance with a previously established rule. But this rule could only be

$$\left. \begin{array}{l}
 F_1(1) = F_2(1), F_1(x + 1) = f\{F_1(x)\} \\
 F_2(x + 1) = f\{F_2(x)\}
 \end{array} \right\} F_1(x) = F_2(x) \dots (\rho).$$

Page 409

But this rule is vague in respect of F_1 , F_2 and f .]

Page 409

We cannot appoint a calculation to be a proof of a proposition.

Page 409

I would like to say: Do we *have to* call the recursive calculation the proof of proposition I? That is, won't another relationship do?

Page 409

(What is infinitely difficult is to "see all round" the calculus.)

Page 409

In the one case "The step is justified" means that it can be carried out in accordance with definite forms that have been given. In the other case the justification might be that the step is taken in accordance with paradigms that themselves satisfy a certain condition.

Page 409

Suppose that for a certain board game rules are given containing only words with no "r" in them, and that I call a rule justified, if it contains no "r". Suppose someone then said, he had laid down only *one* rule for a certain game, namely, that its moves must obey rules containing no "r"s. Is that a rule of the game (in the first sense)? Isn't

the game played in accordance with the class of rules all of which have only to satisfy the first rule?

Page 409

Someone shows me the construction of B and then says that A has been proved. I ask "How? All I see is that you have used $\alpha[\rho]$ to build a construction around A". Then he says "But when that is

Page Break 410

possible, I say that A is proved". To that I answer: "That only shows me the new sense you attach to the word 'prove'."

Page 410

In one sense it means that you have used $\alpha[\rho]$ to construct the paradigm in such and such a way, in another, it means as before that an equation is in accordance with the paradigm.

Page 410

If we ask "is that a proof or not?" we are keeping to the word-language.

Page 410

Of course there can be no objection if someone says: if the terms of a step in a construction are of such and such a kind, I say that the legitimacy of the step is proved.

Page 410

What is it in me that resists the idea of B as a proof of A? In the first place I observe that in my calculation I now here use the proposition about "all cardinal numbers". I used ρ to construct the complex B and then I took the step to the equation A; in all that there was no mention of "all cardinal numbers". (This proposition is a bit of word-language accompanying the calculation, and can only mislead me.) But it isn't only that this general proposition completely drops out, it is that no other takes its place.

Page 410

So the proposition asserting the generalisation drops out; "nothing is *proved*", "nothing *follows*".

Page 410

"But the equation A follows, it is that that takes the place of the general proposition." Well, to what extent does it follow? Obviously, I'm here using "follows" in a sense quite different from the normal one, because what A follows from isn't a proposition. And that is why we feel that the word "follows" isn't being correctly applied.

Page 410

If you say "it follows from the complex B that $a + (b + c) = (a + b) + c$ ", we feel giddy. We feel that somehow or other you've said something nonsensical although outwardly it sounds correct.

Page Break 411

Page 411

That an equation follows, already has a meaning (has its own definite grammar).

Page 411

If I am told "A follows from B", I want to ask: "*what* follows?" That $a + (b + c)$ is equal to $(a + b) + c$, is something postulated, if it doesn't follow in the normal way from an equation.

Page 411

We can't fit our concept of following from to A and B; it doesn't fit.

Page 411

"I will prove to you that $a + (b + n) = (a + b) + n$." No one then expects to see the complex B. You expect to hear another rule for a, b, and n permitting the passage from one side to the other. If instead of that I am given B with the schema $\rho \dagger 1$ I can't call it a proof, because I mean something else by "proof".

Page 411

I shall very likely say something like "oh, so that's what you call a 'proof', I had imagined..."

Page 411

The proof of $17 + (18 + 5) = (17 + 18) + 5$ is certainly carried out in accordance with the schema B, and this numerical proposition is of the form A. Or again: B is a proof of the numerical proposition: but for that very reason, it isn't a proof of A.

Page 411

"I will derive A_I, A_{II}, A_{III} from a single proposition."†2--This

Page Break 412

of course makes one think of a derivation that *makes use* of these propositions--We think we shall be given smaller links of some kind to replace all these large ones in the chain.

Here we have a definite picture; and we are offered something quite different.

The inductive proof puts the equation together as it were crossways instead of lengthways.

If we work out the derivation, we finally come to the point at which the construction of B is completed. But at this point we say "therefore this equation holds"! But these words now don't mean the same as they do when we elsewhere deduce an equation from equations. The words "The equation follows from it" already have a meaning. And although an equation is constructed here, it is by a different principle.

If I say "the equation follows from the complex", then here an equation is 'following' from something that is not an equation.

We can't say: if the equation follows from B, then it does follow from a proposition, namely from $\alpha.\beta.\gamma$; for what matters is *how* I get A from that proposition; whether I do so in accordance with a rule of inference; and what the relationship is between the equation and the proposition $\alpha.\beta.\gamma$. (The rule leading to A in this case makes a kind of cross-section through $\alpha.\beta.\gamma$; it doesn't view the proposition in the same way as a rule of inference does.)

If we have been promised a derivation of A from α and now see the step from B to A, we feel like saying "oh, that isn't what was meant". It is as if someone had promised to give me something and then says: see, I'm giving you my trust.

The fact that the step from B to A is not an inference indicates also what I meant when I said that the logical product $\alpha.\beta.\gamma$ does not express the generalization.

I say that A_I, A_{II} etc. are used in proving $(a + b)^2 = \text{etc.}$ because the steps from $(a + b)^2$ to $a^2 + 2ab + b^2$ are all of the form A_I or A_{II} , etc. In this sense the step in III from $(b + 1) + a$ to $(b + a) + 1$ is also made in accordance with A_I , but the step from $a + n$ to $n + a$ isn't!

The fact that we say "*the correctness* of the equation is proved" shows that not every construction of the equation is a proof.

Someone shows me the complexes B and I say "they are not proofs of the equations A". Then he says: "You still haven't seen the system on which the complexes are constructed", and points it out to me. How could that make the Bs into proofs?

This insight makes me ascend to another, a higher, level; whereas a *proof* would have to be carried out on the lower level.

Nothing except a definite transition to an equation from other equations is a proof of that equation. Here there is no such thing, and nothing else can do anything to make B into a proof of A.

But can't I say that if I have proved this *about* A, I have thereby proved A? Wherever did I get the illusion that by doing this I had proved it? There must surely be some deep reason for this.

Well, if it is an illusion, at all events it arose from our expression in word-language "this proposition holds for *all* numbers"; for on this view the algebraic proposition is only another way of writing the proposition of word-language. And that form of expression caused us to confuse the case of *all* the numbers with the case of 'all the people in this room'. (What we do to distinguish the cases is to ask: how does one verify the one and the other?)

If I suppose the functions ϕ, ψ, F exactly defined and then write the schema for the inductive proof:

$$\begin{array}{r}
\mathbf{R} \\
\left. \begin{array}{l}
\alpha \quad \phi(1) = \psi(1) \\
\beta \quad \phi(c + 1) = F\{\phi(c)\} \\
\gamma \quad \psi(c + 1) = F\{\psi(c)\}
\end{array} \right\} \dots \phi n = \psi n \\
\mathbf{B}
\end{array}
\quad \mathbf{A}$$

Even then I can't say that the step from ϕr to ψr is taken on the basis of ρ (if the step in α, β, γ was made in accordance with ρ --in particular cases $\rho = \alpha$). It is still the equation A it is made in accordance with, and I can only say that it corresponds to the complex B if I regard that as another sign in place of the equation A.

Page 414

For of course the schema for the step had to include α, β and γ .

Page 414

In fact R isn't the schema for the inductive proof B_{III} ; that is much more complicated, since it has to include the schema B_I .

Page 414

The only time it is inadvisable to call something a 'proof' is when the ordinary grammar of the word 'proof' doesn't accord with the grammar of the object under consideration.

Page 414

What causes the profound uneasiness is in the last analysis a tiny but obvious feature of the traditional expression.

Page 414

What does it mean, that R justifies a step of the form A? No doubt it means that I have decided to allow in my calculus only steps in accordance with a schema B in which the propositions α, β, γ are derivable in accordance with ρ . (And of course that would only mean that I allowed only the steps A_I, A_{II} etc., and that those had schemata B corresponding to them).

Page 414

It would be better to write "and those schemata had the form R corresponding to them". The sentence added in brackets was intended to say that the appearance of generality--I mean the generality of the concept of the inductive method--is unnecessary,

Page Break 415

for in the end it only amounts to the fact that the particular constructions B_I, B_{II} , etc. are constructed flanking the equations A_I, A_{II} , etc. Or that in that case it is superfluous to pick out the common feature of the constructions; all that is relevant are the constructions themselves, for there is nothing there except *these* proofs, and the concept under which the proofs fall is superfluous, because we never made any use of it. Just as if I only want to say--pointing to three objects--"put that and that and that in my room", the concept chair is superfluous even though the three objects are chairs. (And if they aren't suitable furniture for sitting on, that won't be changed by someone's drawing attention to a similarity between them.) But that only means, that the individual proof needs our acceptance of it as such (if 'proof' is to mean what it means); and if it doesn't have it no discovery of an analogy with other such constructions can give it to it. The reason why it looks like a proof is that α, β, γ and A are equations, and that a general rule can be given, according to which we can construct (and in that sense derive) A from B.

Page 415

After the event we may become aware of this general rule. (But does that make us aware that the Bs are really proofs of A?) What we become aware of is a rule we might have started with and which in conjunction with α would have enabled us to construct A_I, A_{II} , etc. But no one would have called it a proof in this game.

Page 415

Whence this conflict: "That isn't a proof!" "That surely is a proof."?

Page 415

We might say that it is doubtless true, that in proving B by α I use α to trace the contours of the equation A, but not in the way I call "proving A by α ".

Page 415

The difficulty that needs to be overcome in these discussions is the difficulty of looking at the proof by induction as something new, *naively* as it were.

Page Break 416

So when we said above we could begin with R, this beginning with R is in a way a piece of humbug. It isn't like beginning a calculation by working out 526×718 . For in the latter case setting out the problem is the first step on the journey to the solution. But in the former case I immediately drop the R and have to begin again somewhere else. And when it turns out that I construct a complex of the form R, it is again immaterial whether I explicitly set it out earlier, since setting it out hasn't helped me at all mathematically, i.e. in the calculus. So what is left is just the fact that I now have a complex of the form R in front of me.

We might imagine we were acquainted only with the proof B_I and could then say: all we have is this construction--no mention of an analogy between this and other constructions, or of a general principle in carrying out the constructions.--If I then see B and A like this I'm bound to ask: but why do you call that a proof of A precisely?--(I am not asking: why do you call it a *proof* of A)! What has this complex to do with A_I ? Any reply will have to make me aware of the relation between A and B which is expressed in V.†1

Someone shows us B, and explains to us the relationship with A_I , that is, that the right side of A was obtained in such and such a manner etc. etc. We understand him; and he asks us: is that a proof of A? We would answer: certainly *not*!

Had we understood everything there was to understand about the proof? Had we seen the general form of the connection between A and B? Yes!

We might also infer from that that in this way we can construct a B from every A and *therefore conversely an A from every B as well*.

The proof is constructed on a definite plan (a plan used to construct other proofs as well). But this plan cannot make the proof a proof. For all we have here is one of the embodiments of the plan, and we can altogether disregard the plan as a general concept. The proof has to speak for itself and the plan is only embodied in it, it isn't itself a constituent part of the proof. (That is what I've been wanting to say all the time). Hence it's no use to me if someone draws my attention to the similarity between proofs in order to convince me that they are proofs.

Isn't our principle: not to use a *concept-word* where one isn't necessary?--That means, in cases where the concept word really stands for an enumeration, to say so.

When I said earlier "that isn't a proof" I meant 'proof' in an already established sense according to which it can be gathered from A and B by themselves. In this sense I can say: I understand perfectly well what B does and what relationship it has to A; all further information is superfluous and what is there isn't a proof. In this sense I am concerned only with A and B; I don't see anything beyond them, and nothing else concerns me.

If I do this, I can see clearly enough the relationship in accordance with the rule V, but it doesn't enter my head to use it as an expedient in construction. If someone told me while I was considering B and A that there is a rule according to which we could have constructed B from A (or conversely), I could only say to him "don't bother me with irrelevant trivialities." Because of course it's something that's obvious, and I see immediately that it doesn't make B a proof of A. For the general rule couldn't shew that B is a proof of A *and not of some other proposition*, unless it were

a proof in the first place. That means, that the fact that the connection between B and A is in accordance with a rule can't show that B is a *proof* of A. Any and every such connection could be used as a construction of B from A (and conversely).

So when I said "R certainly isn't used for the construction, so we have no concern with it" I should have said: I am only concerned with A and B. It is enough if I confront A and B with each other and ask: "is B a proof of A?" So I don't need to construct A from B according to a previously established rule; it is sufficient for me to place the particular As--however many there are--in confrontation with particular Bs. I don't need a previously established

construction rule (a rule needed to obtain the As).

Page 418

What I mean is: in Skolem's calculus we don't *need* any such concept, the list is *sufficient*.

Page 418

Nothing is lost if instead of saying "we have proved the fundamental laws A in this fashion" we merely show that we can coordinate with them constructions that resemble them in certain respects.

Page 418

The concept of generality (and of recursion) used in these proofs has no greater generality than can be read immediately from the proofs.

Page 418

The bracket } in R, which unites α , β , and $\gamma \dagger 1$ can't mean any more than that we regard the step in A (or a step of the form A) as justified

Page Break 419

if the terms (sides) of the steps are related to each other in the ways characterized by the schema B. B then takes the place of A. And just as before we said: the step is permitted in my calculus if it corresponds to one of the As, so we now say: it is permitted if it corresponds to one of the Bs.

Page 419

But that wouldn't mean we had gained any simplification or reduction.

Page 419

We are given the calculus of equations. In that calculus "proof" has a fixed meaning. If I now call the inductive calculation a proof, it isn't a proof that saves me checking whether the steps in the chain of equations have been taken in accordance with *these* particular rules (or paradigms). If they have been, I say that the last equation of the chain is proved, or that the chain of equations is correct.

Page 419

Suppose that we were using the first method to check the calculation $(a + b)^3 = \dots$ and at the first step someone said: "yes, that step was certainly taken in accordance with $a(b + c) = a.b + a.c$, but is *that* right?" And then we showed him the inductive derivation of that equation.--

Page 419

The question "Is the equation G right? $\dagger 1$ " means in one meaning: can it be derived in accordance with the paradigms?--In the other case it means: can the equations α , β , γ be derived in accordance with the paradigm (or the paradigms?)--And here we have put the two meanings of the question (or of the word "proof") on the same level (expressed them in a single system) and can now compare them (and see that they are not the same).

Page 419

And indeed the new proof doesn't give you what you might expect: it doesn't base the calculus on a smaller foundation--as happens if we replace $p \vee q$ and $\sim p$ by $p|q$, or reduce the number of axioms, or something similar. For if we now say that all the basic equations A have been derived from ρ alone, the word "derived" here means something quite different. (After this promise we expect

Page Break 420

the big links in the chain to be replaced by smaller ones, not by two half links. $\dagger 1$) And in one sense these derivations leave everything as it was. For in the new calculus the links of the old one essentially continue to exist as links. The old structure is *not* taken to pieces. So that we have to say the proof goes on in the same way as before. And in the *old* sense the irreducibility remains.

Page 420

So we can't say that Skolem has put the algebraic system on to a smaller foundation, for he hasn't 'given it foundations' in the same sense as is used in algebra.

Page 420

In the inductive proof doesn't α show a connection between the As? And doesn't this show that we are here concerned with proofs?--The connection shown is not the one that breaking up the A steps into ρ steps would establish. And *one* connection between the As is already visible before any proof.

Page 420

I can write the rule R like *this*

$$\left. \begin{array}{l} \mathbf{a} + (\mathbf{1} + \mathbf{1}) = (\mathbf{a} + \mathbf{1}) + \mathbf{1} \\ \mathbf{a} + (\boldsymbol{\xi} + \mathbf{1}) = (\mathbf{a} + \boldsymbol{\xi}) + \mathbf{1} \\ \mathbf{a} + ((\boldsymbol{\xi} + \mathbf{1}) + \mathbf{1}) = (\mathbf{a} + (\boldsymbol{\xi} + \mathbf{1})) + \mathbf{1} \end{array} \right\} \mathbf{S}$$

or like this

$$\mathbf{a} + (\mathbf{b} + \mathbf{1}) = (\mathbf{a} + \mathbf{b}) + \mathbf{1}$$

if I take R or S as a definition or substitute for that form†2.

Page 420

Page Break 421

Page 421

If I then say that the steps in accordance with the rule R are justified thus:

$$\left. \begin{array}{l} \boldsymbol{\alpha} \quad \mathbf{a} + (\mathbf{b} + \mathbf{1}) = (\mathbf{a} + \mathbf{b}) + \mathbf{1} \\ \boldsymbol{\beta} \quad \mathbf{a} + (\mathbf{b} + (\mathbf{c} + \mathbf{1})) = \mathbf{a} + ((\mathbf{b} + \mathbf{c}) + \mathbf{1}) = (\mathbf{a} + (\mathbf{b} + \mathbf{c})) + \mathbf{1} \\ \boldsymbol{\gamma} \quad (\mathbf{a} + \mathbf{b}) + (\mathbf{c} + \mathbf{1}) = ((\mathbf{a} + \mathbf{b}) + \mathbf{c}) + \mathbf{1} \end{array} \right\} \mathbf{B}$$

you can reply: "If that's what you call a justification, then you have justified the steps. But you haven't told us any more than if you had just drawn our attention to the rule R and its formal relationship to α (or to α , β , and γ)."

Page 421

So I might also have said: I take the rule R in such and such a way as a paradigm for my steps.

Page 421

Suppose now that Skolem, following his proof of the associative law, takes the step to:

$$\left. \begin{array}{l} \mathbf{a} + \mathbf{1} = \mathbf{1} + \mathbf{a} \\ \mathbf{a} + (\mathbf{b} + \mathbf{1}) = (\mathbf{a} + \mathbf{b}) + \mathbf{1} \\ (\mathbf{b} + \mathbf{1}) + \mathbf{a} = \mathbf{b} + (\mathbf{1} + \mathbf{a}) = \mathbf{b} + (\mathbf{a} + \mathbf{1}) = (\mathbf{b} + \mathbf{a}) + \mathbf{1} \end{array} \right\} \mathbf{C}$$

If he says the first and third steps in the third line are justified according to the already proved associative law, that tells us no more than if he said the steps were taken in accordance with the paradigm $\mathbf{a} + (\mathbf{b} + \mathbf{c}) = (\mathbf{a} + \mathbf{b}) + \mathbf{c}$ (i.e. they correspond to the paradigm) and a schema α , β , γ was derived by steps according to the paradigm α .--"But does B justify these steps, or not?"--"What do you mean by the word 'justify'?--"Well, the step is

Page Break 422

justified if a theorem really has been proved that holds for all numbers"--But in what case would that have happened? What do you call a proof that a theorem holds for all cardinal numbers? How do you know whether a theorem is really valid for all cardinal numbers, since you can't test it? Your *only* criterion is the proof itself. So you *stipulate* a form and call it the form of the proof that a proposition holds for all cardinal numbers. In that case we really gain nothing by being first shown the general form of these proofs; for that doesn't show that the individual proof really gives us what we want from it; because, I mean, it doesn't justify the proof or demonstrate that it is a proof of a theorem for all cardinal numbers. Instead, the recursive proof has to be its own justification. If we really want to justify our proof procedure as a proof of a generalisation of this kind, we do something different: we give a series of examples and then we are satisfied by the examples and the law we recognize in them, and we say: yes our proof really gives us what we want. But we must remember that by giving this series of examples we have only translated the notations B and C into a different notation. (For the series of examples is not an incomplete application of the general form, but another expression of the law.) An explanation in word-language of the proof (of what it proves) only translates the proof into another form of expression: because of this we can drop the explanation altogether. And if we do so, the mathematical relationships become much clearer, no longer obscured by the equivocal expressions of word-language. For example, if I put B right beside A, without interposing any expression of word-language like "for all cardinal numbers, etc." then the misleading appearance of a proof of A by B cannot arise. We then see quite soberly how far the relationships between B and A and $\mathbf{a} + \mathbf{b} = \mathbf{b} + \mathbf{a}$ extend and where they stop. Only thus do we learn the real structure and important features of that relationship, and escape the confusion caused by the form of word-language, which makes everything uniform.

Here we see first and foremost that we are interested in the tree

of the structures B, C, etc., and that in it is visible on all sides, like a particular kind of branching, the following form

$$\begin{aligned}\phi(1) &= \psi(1) \\ \phi(n+1) &= F(\phi n) \\ \psi(n+1) &= F(\psi n)\end{aligned}$$

These forms turn up in different arrangements and combinations but they are not elements of the construction in the same sense as the paradigms in the proof of $(a + (b + (c + 1))) = (a + (b + c)) + 1$ or $(a + b)^2 = a^2 + 2ab + b^2$. The aim of the "recursive proofs" is of course to connect the algebraic calculus with the calculus of numbers. And the tree of the recursive proofs doesn't "justify" the algebraic calculus unless that is supposed to mean that it connects it with the arithmetical one. It doesn't justify it in the sense in which the list of paradigms justifies the algebraic calculus, i.e. the steps in it.

So tabulating the paradigms for the steps makes sense in the cases where we are interested in showing that such and such transformations are all made by means of those transition forms, arbitrarily chosen as they are. But it doesn't make sense where the calculation is to be justified in another sense, where mere looking at the calculation--independently of any comparison with a table of previously established norms--must shew us whether we are to allow it or not. Skolem did not have to promise us any proof of the associative and commutative laws; he could simply have said he would show us a connection between the paradigms of algebra and the calculation rules of arithmetic. But isn't this hair-splitting? Hasn't he reduced the number of paradigms? Hasn't he, for instance, replaced very pair of laws with a single one, namely, $a + (b + 1) = (a + b) + 1$? No. When we prove e.g. $(a + b)^4 = \text{etc.}$ (k) we can while doing so make use of the previously proved proposition $(a + b)^2 = \text{etc.}$ (l). But in that case the steps in k which are justified by l can also be justified by the rules used to prove l. And then the relation of l to those first rules is the same as that of a sign introduced by definition to the primary signs used to define it: we can always eliminate the definitions and go back to the primary signs. But when we take a step in C that is justified by B,

we can't take the same step with $a + (b + 1) = (a + b) + 1$ alone. What is called proof here doesn't break a step in to smaller steps but does something quite different.

The recursive proof does not reduce the number of fundamental laws

So here we don't have a case where a group of fundamental laws is proved by a smaller set while everything else in the proofs remains the same. (Similarly in a system of fundamental concepts nothing is altered in the later development if we use definitions to reduce the number of fundamental concepts.)

(Incidentally, how very dubious is the analogy between "fundamental laws" and "fundamental concepts"!)

It is something like this: all that the proof of a *ci-devant* fundamental proposition does is to continue the system of proofs backwards. But the recursive proofs don't continue backwards the system of algebraic proofs (with the old fundamental laws); they are a new system, that seems only to run parallel with the first one.

It is a strange observation that in the inductive proofs the irreducibility (independence) of the fundamental rules must show itself after the proof no less than before. Suppose we said the same thing about the case of normal proofs (or definitions), where fundamental rules *are* further reduced, and a new relationship between them is discovered (or constructed).

If I am right that the independence remains intact after the recursive proof, that sums up everything I have to say against the concept of recursive "proof".

The inductive proof doesn't break up the step in A. Isn't it that that makes me baulk at calling it a proof? It's that that tempts me to say that whatever it does--even if it is constructed by R and α --it can't do more than show something *about* the step.

If we imagine a mechanism constructed from cogwheels made simply out of uniform wedges held together by a ring, it is still the cogwheels that remain in a certain sense the units of the mechanism.

It is like this: if the barrel is made of hoops and wattles, it is these, combined as they are (as a complex) that hold the liquid and form new units as containers.

Imagine a chain consisting of links which can each be replaced by two smaller ones. Anything which is anchored by the chain can also be anchored entirely by the small links instead of by the large ones. But we might also imagine every link in the chain being made of two parts, each perhaps shaped like half a ring, which together formed a link, but could not individually be used as links.

Then it wouldn't mean at all the same to say, on the one hand: the anchoring done by the large links can be done entirely by small links--and on the other hand: the anchoring can be done entirely by half large links. What is the difference?

One proof replaces a chain with large links by a chain with small links, the other shows how one can put together the old large links from several parts.

The similarity as well as the difference between the two cases is obvious.

Of course the comparison between the proof and the chain is a logical comparison and therefore a completely exact expression of what it illustrates.

Recurring decimals

$$1/3 = 0.\dot{3}$$

We regard the periodicity of a fraction, e.g. of 1/3 as consisting in the fact that something called the extension of the infinite decimal contains only threes; we regard the fact that in this division the remainder is the same as the dividend as a mere *symptom* of this property of the infinite extension. Or else we correct this view by saying that it isn't an infinite extension that has this property, but an infinite series of finite extensions; and it is *of this* that the property of the division is a symptom. We may then say: the extension taken to *one* term is 0.3, to two terms 0.33, to three terms 0.333 and so on. That is a *rule* and the "and so on" refers to the regularity; the rule might also be

$$1/3 = 0.3$$

written " $0.3, 0.\xi, 0.\xi3$ " But what is proved by the division $1/3 = 0.\dot{3}$ is *this* regularity in contrast to another, not

$$1/3 = 0.3$$

$$1/3 = 0.3$$

regularity in contrast to irregularity. The periodic division $1/3 = 0.\dot{3}$ (in contrast to $1/3 = 0.3$) proves a periodicity in the quotient, that is it *determines* the rule (the repetend), it lays it down; it isn't a symptom that a regularity is "already there". *Where* is it already? In things like the particular expansions that I have written on this paper. But they aren't "*the* expansions". (Here we are misled by the idea of unwritten ideal extensions, which are a phantasm like those ideal, undrawn, geometric straight lines of which the actual lines we draw are mere tracings.) When I said "the 'and so on' refers to the regularity" I was distinguishing it from the 'and so on' in "he read all the letters of the alphabet: a, b, c and so on". When I say "the extensions of 1/3 are 0.3, 0.33, 0.333 and so on" I give three *three*

$$1/3 = 0.3$$

extensions and--a rule. That is the only thing that is infinite, and only in the same way as the division $1/3 = 0.\dot{3}$

One can say of the sign $0.\dot{3}$ that it is not an abbreviation.

And the sign " $|0\cdot3, 0\cdot\xi, 0\cdot\xi3|$ " isn't a substitute for an extension, but the undevalued sign itself; and " $0.\dot{3}$ "

does just as well. It should give us food for thought, that a sign like " $0.\dot{3}$ " is *enough* to do what we need. It isn't a mere substitute in the calculus there are no substitutes.

Page 428

$$1/3 = 0.\dot{3}$$

If you think that the peculiar property of the division $\frac{1}{3}$ is a symptom of the periodicity of the infinite decimal fraction, or *the* decimal fractions of the expansion, it is indeed a sign that something *is* regular, but *what?* The extensions that I have constructed? But there aren't any others. It would be a most absurd manner of speaking to say: the property of the division is an indication that the result has the form " $|0\cdot a, 0\cdot\xi, 0\cdot\xi a|$ "; that is like

wanting to say that a division was an indication that the result was a number. The sign " $0.\dot{3}$ " does not express its meaning from any greater distance than " $0\cdot333\dots$ ", because this sign gives an extension of three terms and a rule; the extension $0\cdot333$ is inessential for our purposes and so there remains only the rule, which is given just as well by " $|0\cdot3, 0\cdot\xi, 0\cdot\xi3|$ ". The proposition "After the first place the division is periodic" just means "The first remainder is the same as the dividend". Or again: the proposition "After the first place the division will yield the same number to infinity", *means* "The first remainder is the same as the dividend", just as the proposition "This straightedge has an infinite radius" means it is straight.

Page 428

We might now say: the places of a quotient of $1/3$ are *necessarily*

Page Break 429

all 3s, and all that could mean would be again that the first remainder is like the dividend and the first place of the quotient is 3. The negation of the first proposition is therefore equivalent to the negation of the second. So the opposite of "necessarily all" isn't what one might call "accidentally all"; "necessarily all" is as it were one word. I only have to ask: what is the criterion of the necessary generalization, and what would be the criterion of the accidental generalization (the criterion for all numbers accidentally having the property ϵ)?

Page Break 430

The recursive proof as a series of proofs

Page 430

A "recursive proof" is the general term of a series of proofs. So it is a law for the construction of proofs. To the question how this general form can save me the proof of a particular proposition, e.g. $7 + (8 + 9) = (7 + 8) + 9$, the answer is that it merely gets everything ready for the proof of the proposition, it doesn't prove it (indeed the proposition doesn't occur in it). The proof consists rather of the general form plus the proposition.

Page 430

Our normal mode of expression carries the seeds of confusion right into its foundations, because it uses the word "series" both in the sense of "extension", and in the sense of "law". The relationship of the two can be illustrated by a machine for making coiled springs, in which a wire is pushed through a *helically* shaped

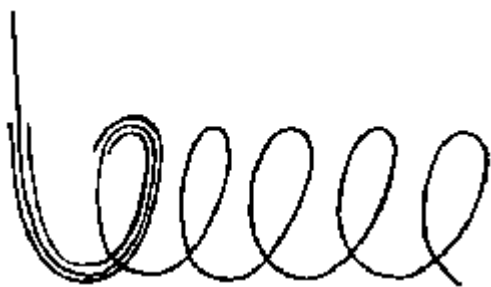

passage to make as many coils as are desired. What is called an infinite helix need not be anything like a finite piece of wire, or something that that approaches the longer it becomes; it is the law of the helix, as it is embodied in the short passage. Hence the expression "infinite helix" or "infinite series" is misleading.

Page 430

So we can always write out the recursive proof as a limited series with "and so on" without its losing any of its rigour. At the same time this notation shows more clearly its relation to the equation A. For then the recursive proof no longer looks at all like a justification of A in the sense of an algebraic proof--like the proof

of $(a + b)^2 = a^2 + 2ab + b^2$. That proof with algebraic calculation rules is quite like calculation with numbers.

$$\begin{aligned} 5 + (4 + 3) &= 5 + (4 + (2 + 1)) = 5 + ((4 + 2) + 1) = \\ &= (5 + (4 + 2)) + 1 = (5 + (4 + (1 + 1))) + 1 = \\ &= (5 + ((4 + 1) + 1)) + 1 = ((5 + (4 + 1)) + 1) + 1 = \\ &= (((5 + 4) + 1) + 1) + 1 = ((5 + 4) + 2) + 1 = (5 + 4) + 3 \dots (L) \end{aligned}$$

Page 431

That is a proof of $5 + (4 + 3) = (5 + 4) + 3$, but we can also let it count, i.e. use it, as a proof of $5 + (4 + 4) = (5 + 4) + 4$, etc.

Page 431

If I say that L is the proof of the proposition $a + (b + c) = (a + b) + c$, the oddness of the step from the proof to the proposition becomes much more obvious.

Page 431

Definitions merely introduce practical abbreviations; we could get along without them. But is that true of recursive definitions?

Page 431

Two different things might be called applications of the rule $a + (b + 1) = (a + b) + 1$: in one sense $4 + (2 + 1) = (4 + 2) + 1$ is an application, in another sense $4 + (2 + 1) = ((4 + 1) + 1) + 1 = (4 + 2) + 1$ is.

Page 431

The recursive definition is a rule for constructing replacement rules, or else the general term of a series of definitions. It is a signpost that shows the *same* way to all expressions of a certain form.

Page 431

As we said, we might write the inductive proof without using letters at all (with no loss of rigour). Then the recursive definition $a + (b + 1) = (a + b) + 1$ would have to be written as a series of definitions. As things are, this series is concealed in the explanation of its use. Of course we can keep the letters in the definition for the sake of convenience, but in that case in the explanation we have to bring in a sign like " $|1, (1) + 1, ((1) + 1) + 1$ and so on", or, what boils down to the same thing, " $|1, \xi, \xi + 1|$ ". But here we mustn't believe that this sign should really be " $(\xi).|1, \xi, \xi + 1|$ "!

Page 432

The point of our formulation is of course that the concept "all numbers" is given only by a structure like " $|1, \xi, \xi + 1|$ ". The generality is *set out* in the symbolism by this structure and cannot be *described* by an $(x).fx$.

Page 432

Of course the so-called "recursive definition" isn't a definition in the customary sense of the word, because it isn't an equation, since the equation " $a + (b + 1) = (a + b) + 1$ " is only a part of it. Nor is it a logical product of equations. Instead, it is a law for the construction of equations; just as $|1, \xi, \xi + 1|$ isn't a number but a law etc. (The bewildering thing about the proof of $a + (b + c) = (a + b) + c$ is of course that it's supposed to come out of the definition alone. But α isn't a definition, but a general rule for addition).

Page 432

$$1/3 = 0.3$$

On the other hand the generality of this rule is no different from that of the periodic division $1/3$. That means, there isn't anything that the rule leaves open or in need of completion or the like.

Page 432

Let us not forget: the sign " $|1, \xi, \xi + 1|$ "... N interests us not as a striking expression for the general term of the series of cardinal numbers, but only in so far as it is contrasted with signs of similar construction. *Nas opposed to* something like $|2, \xi, \xi + 3|$; in short, as a sign, or an instrument, in a calculus. And of course the same holds for $1/3 = 0.3$

1 . (The only thing left open in the rule is its application.)

$$\begin{aligned} 1 + (1 + 1) &= (1 + 1) + 1, \quad 2 + (1 + 1) = (2 + 1) + 1, \quad 3 + (1 + 1) = (3 + 1) + 1 \dots \text{and so on} \\ 1 + (2 + 1) &= (1 + 2) + 1, \quad 2 + (2 + 1) = (2 + 2) + 1, \quad 3 + (2 + 1) = (3 + 2) + 1 \dots \text{and so on} \\ 1 + (3 + 1) &= (1 + 3) + 1, \quad 2 + (3 + 1) = (2 + 3) + 1, \quad 3 + (3 + 1) = (3 + 3) + 1 \dots \text{and so on} \\ &\text{and so on.} \end{aligned}$$

We might write the rule " $a + (b + 1) = (a + b) + 1$ ", thus.†1

$$\left| \begin{array}{l} a + (1 + 1) = (a + 1) + 1 \\ \downarrow \qquad \qquad \downarrow \\ a + (\xi + 1) \quad (a + \xi) + 1 \\ a + ((\xi + 1) + 1) \quad ((a + \xi) + 1) + 1 \end{array} \right| \mathbf{R}$$

In the application of the rule R (and the description of the application is of course an inherent part of the sign for the rule), a ranges over the series $|1, \xi, \xi + 1|$; and of course that might be expressly stated by an additional sign, say " $a \rightarrow N$ ". (We might call the second and third lines of the rule R taken together the operation, like the second and third term of the sign N.) Thus too the explanation of the use of the recursive definition " $a + (b + 1) = (a + b) + 1$ " is a part of that rule itself; or if you like a repetition of the rule in another form; just as " $1, 1 + 1, 1 + 1 + 1$ and so on" means the *same* as (i.e. is translatable into) " $|1, \xi, \xi + 1|$ ". The translation into word-language *casts light on* the calculus with the new signs, because we have already mastered the calculus with the signs of word-language.

The sign of a rule, like any other sign, is a sign belonging to a calculus; its job isn't to hypnotize people into accepting an application, but to be used in the calculus in accordance with a system. Hence the exterior form is no more essential than that of an arrow \rightarrow ; what is essential is the system in which the sign for the rule is employed. The system of contraries--so to speak--from which the sign is distinguished etc.

What I am here calling the description of the application is itself of course something that contains an "and so on", and so it can itself be no more than a supplement to or substitute for the rule-sign.

What is the contradictory of a general proposition like $a + (b + (1 + 1)) = a + ((b + 1) + 1)$? What is the system of propositions within which this proposition is negated? Or again, how, and in what form, can this proposition come into contradiction with others? What question does it answer? Certainly not the question

whether $(n).fn$ or $(\exists n).\sim fn$ is the case, because it is the rule R that contributes to the generality of the proposition. The generality of a rule is *eo ipso* incapable of being brought into question.

Now imagine the general rule written as a series

- P11, P12, P13...
- P21, P22, P23...
- P31, P32, P33...
-

and then negated. If we regard it as $(x).fx$, then we are treating it as a logical product and its opposite is the logical sum of the denials of p_{11}, p_{12} etc. This disjunction can be combined with any random product $p_{11} \cdot p_{21} \cdot p_{22} \cdot \dots \cdot p_{mn}$. (Certainly if you compare the proposition with a logical product, it becomes infinitely significant and its opposite void of significance). (But remember that the "and so on" in the proposition comes after a comma, not after an "and" (".") The "and so on" is not a sign of *incompleteness*.)

Is the rule R infinitely significant? Like an enormously long logical product?

That one can run the number series though the rule is a form that is given; nothing is affirmed about it and nothing can be denied about it.

Running the stream of numbers through is not something which I can say I can prove. I can only prove something about the form, or pattern, through which I run the numbers.

But can't we say that the general number rule $a + (b + c) = (a + b) + c \dots$ A) has the same generality as $a + (1 +$

1) = (a + 1) + 1 (in that the latter holds for every cardinal number and the former for every triple of cardinal numbers) and that the inductive proof of A justifies the rule A? Can we say that we can give the rule A, since the

$$\frac{1}{3} = 0.3$$

proof shows that it is always right? Does **I** justify the rule

$$\frac{1}{3} = 0.3, \frac{1}{3} = 0.333, \frac{1}{3} = 0.333 \dots$$

and so on?"...P) A is a completely intelligible rule; just like the replacement rule P. But I can't give such a rule, for the reason that I can already

Page Break 435

calculate the particular instances of A by another rule; just as I cannot give P as a rule if I have given a rule whereby I

can calculate $\frac{1}{3} = 0.3$ etc.

Page 435

How would it be if someone wanted to lay down "25 × 25 = 625" as a rule in addition to the multiplication rules. (I don't say "25 × 25 = 624"!)-25 × 25 = 625 only makes sense if the kind of calculation to which the equation belongs is already known, and it only makes sense in connection with that calculation. A only makes sense in connection with A's own kind of calculation. For the first question here would be: is that a stipulation, or a derived proposition? If 25 × 25 = 625 is a stipulation, then the multiplication sign does not mean the same as it does, e.g. in reality (that is, we are dealing with a different kind of calculation). And if A is a stipulation, it doesn't define addition in the same way as if it is a derived proposition. For in that case the stipulation is of course a definition of the addition sign, and the rules of calculation that allow A to be worked out are a different definition of the same sign. Here I mustn't forget that α, β, γ isn't the proof of A, but only the form of the proof, or of what is proved; so α, β, γ is a definition of A.

Page 435

Hence I can only say "25 × 25 = 625 is proved" if the method of proof is fixed independently of the specific proof. For it is this method that settles the meaning of "ξ × η" and so settles what is proved. So to that extent the

$$a \cdot b = c$$

form **a** belongs to the method of proof that explains the sense of c. Whether I have calculated correctly is another question. And similarly α, β, γ belong to the method of proof that defines the sense of the proposition A.

Page 435

Arithmetic is complete without a rule like A; without it it doesn't lack anything. The proposition A is introduced into arithmetic with the discovery of a periodicity, with the construction of a new calculus. Before this discovery or construction a question about the correctness of that proposition would have as little sense as a question about the correctness of "1/3 = 0.3, 1/3 = 0.33... ad inf."

Page Break 436

Page 436

The stipulation of P is not the same thing as the proposition "1/3 = 0.3" and in that sense "a + (b + **c**) = (a + b) + **c**" is different from a rule (stipulation) such as A. The two belong to different calculi. The proof of α, β, γ is a proof or justification of a rule like A only in so far as it is the general form of the proof of arithmetical propositions of the form A.

Page 436

Periodicity is not a sign (symptom) of a decimal's recurring; the expression "it goes on like that for ever" is only a translation of the sign for periodicity into another form of expression. (If there was something other than the periodic sign of which periodicity was only a symptom, that something would have to have a specific expression, which could be nothing less than the complete expression of that something.)

Page Break 437

Seeing or viewing a sign in a particular manner. Discovering an aspect of a mathematical expression. "Seeing an expression in a particular way". Marks of emphasis.

Page 437

Earlier I spoke of the use of connection lines, underlining etc. to bring out the corresponding, homologous, parts of

the equations of a recursion proof. In the proof

$$\begin{array}{l}
 a + (b + \overset{\gamma}{1}) = (a + b) + \overset{\alpha}{1} \\
 a + (b + (\underbrace{c + 1}_{\delta})) = (a + (b + c)) + \overset{\beta}{1} \\
 (a + b) + (\underbrace{c + 1}_{\xi}) = ((a + b) + c) + \overset{\epsilon}{1}
 \end{array}$$

the one marked α for example corresponds not to β but to c in the next equation; and β corresponds not to δ but to ϵ ; and γ not to δ but to $c + \delta$, etc.

Or in

$$\begin{array}{l}
 \overset{\alpha}{(a + 1)} + \overset{\beta}{1} = (\overset{\kappa}{a} + \overset{\lambda}{1}) + \overset{\zeta}{1} \\
 \overset{\gamma}{1} + (\overset{\delta}{a + 1}) = (\overset{\mu}{1} + \overset{\eta}{a}) + \overset{\theta}{1}
 \end{array}$$

ι doesn't correspond to κ and ϵ doesn't correspond to λ ; it is β that ι corresponds to; and β does not correspond to ξ , but ξ corresponds to θ and α to δ and β to γ and γ to μ , not to θ , and so on.

Page 437

What about a calculation like

$$(5 + 3)^2 = (5 + 3) \cdot (5 + 3) = 5 \cdot (5 + 3) + 3 \cdot (5 + 3) = 5 \cdot 5 + 5 \cdot 3 + 3 \cdot 5 + 3 \cdot 3 = 5^2 + 2 \cdot 5 \cdot 3 + 3^2 \dots R$$

from which we can also read a general rule for the squaring of a binomial?

Page 437

We can as it were look at this calculation arithmetically or algebraically.

Page Break 438

Page 438

This difference between the two ways of looking at it would have been brought out e.g. if the example had been written

$$(5 + 2)^2 = 5^2 + \overset{\alpha}{2} \cdot \overset{\beta}{2} \cdot 5 + \overset{\beta}{2}^2$$

In the algebraic way of looking at it we would have to distinguish the 2 in the position marked α from the 2s in the positions marked β but in the arithmetical one they would not need to be distinguished. We are--I believe--using a different calculus in each case.

Page 438

According to one but not the other way of looking at it the calculation above, for instance, would be a proof of $(7 + 8)^2 = 8^2 + 2 \cdot 7 \cdot 8 + 8^2$.

Page 438

We might work out an example to make sure that $(a + b)^2$ is equal to $a^2 + b^2 + 2ab$, not to $a^2 + b^2 + 3ab$ --if we had forgotten it for instance; but we couldn't check in that sense whether the formula holds *generally*. But of course there is *that sort of* check too, and in the calculation

$$(5 + 3)^2 = \dots = 5^2 + 2 \cdot 5 \cdot 3 + 3^2$$

I might check whether the 2 in the second summand is a general feature of the equation or something that depends

on the particular numbers occurring in the example.

I turn $(5 + 2)^2 = 5^2 + 2 \cdot 2 \cdot 5$ into another sign, if I write

$$\overset{\alpha}{(5 + 2)}^2 = \overset{\alpha}{5}^2 + \overset{\beta}{2} \cdot \overset{\alpha}{2} \cdot \overset{\beta}{5} + \overset{\beta}{2}^2$$

and thus "indicate which features of the right hand side originate from the particular numbers on the left" etc.

Page 438

(Now I realize the importance of this process of coordination. It expresses a new way of looking at the calculation and therefore a way of looking at a new calculation.)

Page 438

In order to prove A'--we could say--I first of all have to draw attention to quite definite features of B. (As in

$$1 \cdot 0 / 3 = 0 \cdot 3$$

the division $1 \quad \quad \quad$).

Page Break 439

Page 439

(And α had no suspicion, so to speak, of what I see if I do.)

Page 439

Here the relationship between generality and proof of generality is like the relationship between existence and proof of existence.

Page 439

When α, β, γ are proved, the general calculus has still to be discovered.

Page 439

Writing " $a + (b + c) = (a + b) + c$ " in the induction series seems to us a matter of course, because we don't see that by doing so we are starting a totally new calculus. (A child just learning to do sums would see dearer than we do in this connection.)

Page 439

Certain features are brought out by the schema R; they could be specially marked thus: $\dagger 1$

$$\overbrace{a + (b + 1)}^{f_1(1)} = \overbrace{(a + b) + 1}^{f_2(1)}$$

$$\overbrace{a + (b + (c + 1))}^{f_1(c + 1)} = \overbrace{(a + (b + c)) + 1}^{f_1(c) + 1}$$

$$\overbrace{(a + b) + (c + 1)}^{f_2(c + 1)} = \overbrace{((a + b) + c) + 1}^{f_2(c) + 1}$$

Of course it would also have: been enough (i.e. it would have been a symbol of the same multiplicity) if we had written B and added

$$f_1 \xi = a + (b + \xi), f_2 \xi = (a + b) + \xi$$

Page 439

(Here we must also remember that *every* symbol--however explicit--*can* be misunderstood.)

Page 439

The first person to draw attention to the fact that B can be seen in that way introduces a new sign whether or not he goes on to attach special marks to B or to write the schema R beside it. In

Page Break 440

the latter case R itself is the new sign, or, if you prefer, B plus R. It is the way in which he draws attention to it that produces the new sign.

Page 440

We might perhaps say that here the lower equation is used as $a + b = b + a$; or similarly that here B is used as A, by being as it were read sideways. Or: B was used as A, but the new proposition was built up from $\alpha.\beta.\gamma$, in such a way that though A is now read out of B, $\alpha.\beta.\gamma$ don't appear in the sort of abbreviation in which the premisses turn up in the conclusion.

Page 440

What does it mean to say: "I am drawing your attention to the fact that the same sign occurs here in both function signs (perhaps you didn't notice it)"? Does that mean that he didn't understand the proposition?--After all, what he didn't notice was something which belonged essentially to the proposition; it wasn't as if it was some external property of the proposition he hadn't noticed (Here again we see what kind of thing is called "understanding a proposition".)

Page 440

Of course the picture of reading a sign lengthways and sideways is once again a *logical* picture, and for that reason it is a perfectly exact expression of a grammatical relation. We mustn't say of it "it's a mere metaphor, who knows what the facts are really like?"

Page 440

When I said that the new sign with the marks of emphasis must have been derived from the old one without the marks, that was meaningless, because of course I can consider the sign with the marks without regard to its origin. In that case it presents itself to me as three equations [Frege]†1, that is as the shape of three equations with certain underlinings, etc.

Page Break 441

Page 441

It is certainly significant that this shape is quite similar to the three equations without the underlinings; it is also significant that the cardinal number 1 and the rational number 1 are governed by similar rules; but that does not prevent what we have here from being a new sign. What I am now doing with this sign is something quite new.

Page 441

Isn't this like the supposition I once made that people might have operated the Frege-Russell calculus of truth-functions with the signs "~" and "." combined into "~p.~q" without anyone noticing, and that Sheffer, instead of giving a new definition, had merely drawn attention to a property of the signs already in use.

Page 441

We might have gone on dividing without ever becoming aware of recurring decimals. When we have seen them, we have seen something new.

Page 441

But couldn't we extend that and say "I might have multiplied numbers together without ever noticing the special case in which I multiply a number by itself; and that means x^2 is not simply $x.x$ "? We might call the invention of the sign ' x^2 ' the expression of our having become aware of that special case. Or, we might have gone on

multiplying a by b and dividing it by c without noticing that we could write " $\frac{a.b}{c}$ " as "a.(b|c)" or that the latter is similar to a.b. Or again, this is like a savage who doesn't yet see the analogy between |||| and |||||, or between || and |||||.

$$[a + (b + 1) \underline{\underline{\alpha}} (a + b) + 1] \& [a + (b + (c + 1)) \underline{\underline{\beta}} (a + (b + c)) + 1] \& [(a + b) + (c + 1) \underline{\underline{\gamma}} ((a + b) + c) + 1].$$

Def
 $\underline{\underline{=}} .a + (b + c).\exists.(a + b) + c... U)$

and in general:

$$[f_1(1) \underline{\underline{\rho}} f_2(1)] \& [f_1(c + 1) \underline{\underline{\beta}} f_1(c) + 1] \& [f_2(c + 1) \underline{\underline{\gamma}} = f_2(c) + 1]. \underline{\underline{Def}} .f_1(c).\exists.f_2(c)... V)$$

Page Break 442

Page 442

You might see the definition U, without knowing why I use that abbreviation.

Page 442

You might see the definition without understanding its point.--But its point is something new, not something already contained in it as a specific replacement rule.

Page 442

Of course, " \mathfrak{S} " isn't an equals-sign in the same sense as the ones occurring in α , β , γ .

Page 442

But we can easily show that " \mathfrak{S} " has certain formal properties in common with $=$.

Page 442

It would be incorrect--according to the postulated rules--to use the equals-sign like this:

$$\begin{aligned} \Delta \dots |(a + b)^2 = a.(a + b) + b.(a + b) = \dots = \\ = a^2 + 2ab + b^2|. = .|(a + b)^2 = a^2 + 2ab + b^2| \end{aligned}$$

if that is supposed to mean that the left hand side is the proof of the right.

Page 442

But mightn't we imagine this equation regarded as a definition? For instance, if it had always been the custom to write out the whole chain instead of the right hand side, and we introduced the abbreviation.

Page 442

Of course Δ can be regarded as a definition! Because the sign on the left hand side is in fact used, and there's no reason why we shouldn't abbreviate it according to this convention. Only in that case either the sign on the right or the sign on the left is used in a way different from the one now usual.

Page 442

It can never be sufficiently emphasized that *totally different* kinds of sign-rules get written in the form of an equation.

Page 442

The 'definition' $x.x = x^2$ might be regarded as merely allowing us to replace the sign " $x.x$ " by the sign " x^2 ," like the definition " $1 + 1 = 2$ "; but it can also be regarded (and in fact is regarded) as allowing us to put a^2 instead of $a.a$, and $(a + b)^2$ instead of $(a + b).(a + b)$ and in such a way that any arbitrary number can be substituted for the x .

Page Break 443

Page 443

A person who discovers that a proposition p follows from one of the form $q \supset p.q$ constructs a new sign, the sign for that rule. (I am assuming that a calculus with p , q , \supset , has already been in use, and that this rule is now added to make it a new calculus.)

Page 443

It is true that the notation " x^2 " takes away the possibility of replacing one of the factors x by another number. Indeed, we could imagine two stages in the discovery (or construction) of x^2 . At first, people might have written " $x.x$ " instead of " x^2 ", before it occurred to them that there was a system $x.x$, $x.x.x$, etc.; later, they might have hit upon that too. Similar things have occurred in mathematics countless times. (In Liebig's sign for an oxide oxygen did not appear as an element in the same way as what was oxidized. Odd as it sounds, we might even today, with all the data available to us, give oxygen a similarly privileged position--only, of course, in the *form of representation*--by adopting an incredibly artificial interpretation, i.e. grammatical construction.)

Page 443

The definitions $x.x = x^2$, $x.x.x = x^3$ don't bring anything into the world except the signs " x^2 " and " x^3 " (and thus so far it isn't necessary to write numbers as exponents).

[The process of generalization creates a new sign-system.]

Page 443

Of course Sheffer's discovery is not the discovery of the definition $\sim p.\sim q = p|q$. Russell might well have given that definition without being in possession of Sheffer's system, and on the other hand Sheffer might have built up his system without the definition. His system is contained in the use of the signs " $\sim p.\sim p$ " for " $\sim p$ " and " $\sim(\sim p.\sim q).\sim(\sim p.\sim q)$ " for " $p \vee q$ " and all " $p|q$ " does is to permit an *abbreviation*. Indeed, we can say that someone could well have been acquainted with the use of the sign " $\sim(\sim p.\sim q).\sim(\sim p.\sim q)$ " for " $p \vee q$ " without recognizing the system $p|q$.| $p|q$ in it.

Page Break 444

Page 444

It makes matters clearer if we adopt Frege's two primitive signs " \sim " and " $.$ ". The discovery isn't lost if the definitions are written $\sim p.\sim p = \sim p$ and $\sim(\sim p.\sim p).\sim(\sim q.\sim q) = p.q$. Here apparently nothing at all has been altered in the original signs.

But we might also imagine someone's having written the whole Fregean or Russellian logic in this system, and yet, like Frege, calling "~" and "." his primitive signs, because he did not see the other system in his proposition.

It is clear that the discovery of Sheffer's system in $\sim.p.\sim p = \sim p$ and $\sim(\sim p.\sim p).\sim(\sim q.\sim q) = p.q$ corresponds to the discovery that $x^2 + ax + a^2/4$ is a specific instance of $a^2 + 2ab + b^2$.

We don't see that something can be looked at in a certain way until it is so looked at.

We don't see that an aspect is possible until it is there.

That sounds as if Sheffer's discovery wasn't capable of being represented in signs at all. (Periodic division.) But that is because we can't smuggle the *use* of the sign into its introduction (the rule is and remains a sign, separated from its application).

Of course I can only apply the general rule for the induction proof when I discover the substitution that makes it applicable. So it would be possible for someone to see the equations

$$(a + 1) + 1 = (a + 1) + 1$$

$$1 + (a + 1) = (1 + a) + 1$$

without hitting on the substitution

$$a = x, F_1(x) = x + 1, F_1(x + 1) = (x + 1) + 1,$$

$$F_2(x + 1) = 1 + (x + 1), F_2(x) = 1 + x$$

Moreover, if I say that I *understand* the equations as particular cases of the rule, my understanding has to be the understanding that shows itself in the explanations of the relations between the rule and the equations, i.e. what we express by the substitutions. If I don't regard that as an expression of what I understand, then nothing is an expression of it; but in that case it makes no sense either to speak of understanding or to say that I understand something definite. For it only makes sense to speak of understanding in cases where we understand *one* thing as opposed to another. And it is this contrast that signs express.

Indeed, seeing the internal relation must in its turn be seeing something that can be described, something of which one can say: "I see that such and such is the case"; it has to be really something of the same kind as the correlation-signs (like connecting lines, brackets, substitutions, etc.). Everything else has to be contained in the application of the sign of the general rule in a particular case.

It is as if we had a number of material objects and discovered they had surfaces which enabled them to be placed in a continuous row. Or rather, as if we discovered that such and such surfaces, which we had seen before, enabled them to be placed in a continuous row. That is the way many games and puzzles are solved.

The person who discovers periodicity invents a new calculus. The question is, how does the calculus with periodic division differ from the calculus in which periodicity is unknown?

(We might have operated a calculus with cubes without having had the idea of putting them together to make prisms.)

Appendix†1

(On: The process of generalization creates a new sign-system)

It is a very important observation that the c in A is not the same variable as the c in β and γ . So the way I wrote out the proof was not quite correct in a respect which is very important for us. In A we could substitute n for c , whereas the c s in β and γ are identical.

Page 446

But another question arises: can I derive from A that $i + (k + c) = (i + k) + c$? If so, why can't I derive it in the same way from B ? Does that mean that a and b in A are not identical with a and b in α , β and γ ?

Page 446

We see clearly that the variable c in B isn't identical with the c in A if we put a number instead of it. Then B is something like

$$\left. \begin{array}{l} \alpha \quad 4 + (5 + 1) = (4 + 5) + 1 \\ \beta \quad 4 + (5 + (6 + 1)) = (4 + (5 + 6)) + 1 \\ \gamma \quad (4 + 5) + (6 + 1) = ((4 + 5) + 6) + 1 \end{array} \right\} \dots W$$

but that doesn't have corresponding to it an equation like $A_W: 4 + (5 + 6) = (4 + 5) + 6!$

Page 446

What makes the induction proof different from a proof of A is expressed in the fact that the c in B is not identical with the one in A , so that we could use different letters in the two places.

Page 446

All that is meant by what I've written above is that the reason it looks like an algebraic proof of A is that we think we meet the same variables a , b , c in the equations A as in α , β , γ and so we

Page Break 447

regard A as the result of a transformation of those equations. (Whereas of course in reality I regard the signs α , β , γ in quite a different way, which means that the c in β and γ isn't used as a variable in the same way as a and b . Hence one can express this new view of B , by saying that the c does not occur in A .)

Page 447

What I said about the new way of regarding α , β , γ might be put like this: α is used to build up β and γ in exactly the same way as the fundamental algebraic equations are used to build up an equation like $(a + b)^2 = a^2 + 2ab + b^2$. But if that is the way they are derived, we are regarding the complex $\alpha \beta \gamma$ in a new way when we give the variable c a function which differs from that of a and b (c becomes the hole through which the stream of numbers has to flow).

Page Break 448

Proof by induction, arithmetic and algebra

Page 448

Why do we need the commutative law? Not so as to be able to write the equation $4 + 6 = 6 + 4$, because that equation is justified by its own particular proof. Certainly the proof of the commutative law can also be used to prove it, but in that case it becomes just a particular arithmetical proof. So the reason I need the law, is to apply it when using letters.

Page 448

And it is this justification that the inductive proof cannot give me.

Page 448

However, one thing is clear: if the recursive proof gives us the right to calculate algebraically, then so does the arithmetical proof $L \dagger 1$.

Page 448

Again: the recursive proof is--of course--essentially concerned with numbers. But what use are numbers to me when I want to operate purely algebraically? Or again, the recursion proof is only of use to me when I want to use it to justify a step in a number-calculation.

Page 448

But someone might ask: do we need *both* the inductive proof *and* the associative law, since the latter cannot provide a foundation for calculation with numbers, and the former cannot provide one for transformations in algebra?

Page 448

Well, before Skolem's proof was the associative law, for example, just accepted without anyone's being able

to work out the corresponding step in a numerical calculation? That is, were we previously unable to work out $5 + (4 + 3) = (5 + 4) + 3$, and did we treat it as an axiom?

Page 448

If I say that the periodic calculation proves the proposition that justifies me in those steps, what would the proposition have been

Page Break 449

like if it had been assumed as an axiom instead of being proved?

Page 449

What would a proposition be like that permitted one to put $5 + (7 + 9) = (5 + 7) + 9$ without being able to prove it? It is obvious that there never has been such a proposition.

Page 449

But couldn't we also say that the associative law isn't used at all in arithmetic and that we work only with particular number calculations?

Page 449

Even when algebra uses arithmetical notation, it is a *totally different* calculus, and cannot be derived from the arithmetical one.

Page 449

To the question "is $5 \times 4 = 20$ "? one might answer: "let's check whether it is in accord with the basic rules of arithmetic" and similarly I might say: let's check whether A is in accord with the basic rules. But with which rules? Presumably with α .

Page 449

But before we can bring α and A together we need to stipulate what we want to call "agreement" here.

Page 449

That means that α and A are separated by the gulf between arithmetic and algebra,†1 and if B is to count as a proof of A, this gulf has to be bridged over by a stipulation.

Page 449

It is quite clear that we do use an idea of this kind of agreement when, for instance, we quickly work out a numerical example to check the correctness of an algebraic proposition.

Page 449

And in this sense I might e.g. calculate

$$\begin{array}{r} 25 \times 16 \\ \hline 25 \\ 150 \\ \hline 400 \end{array} \qquad \begin{array}{r} 16 \times 25 \\ \hline 32 \\ 80 \\ \hline 400 \end{array}$$

Page Break 450

and say: "yes, it's right, a.b is equal to b.a"--if I imagine that I have forgotten.

Page 450

Considered as a rule for algebraic calculation, A cannot be proved recursively. We would see that especially dearly if we wrote down the "recursive proof" as a series of arithmetical expressions. Imagine them written down (i.e. a fragment of the series plus "and so on") without any intention of "proving" anything, and then suppose someone asks: "does that prove $a + (b + c) = (a + b) + c$ ". We would ask in astonishment "How can it prove anything of the kind? The series contains only numbers, it doesn't contain any letters".--But no doubt we might say: if I introduce A as a rule for calculation with letters, that brings this calculus in a certain sense into unison with the calculus of the cardinal numbers, the calculus I established by the law for the rules of addition (the recursive definition $a + (b + 1) = (a + b) + 1$).

Page Break 451

VII INFINITY IN MATHEMATICS: THE EXTENSIONAL VIEWPOINT

"What is the sense of such a proposition as ' $(\exists n).3 + n = 7$ '?" Here we are in an odd difficulty: on the one hand we feel it to be a problem that the proposition has the choice between infinitely many values of n , and on the other hand the sense of the proposition seems guaranteed in itself and only needing further research on our part, because after all we "know 'what $(\exists x) \phi x$ ' means". If someone said he didn't know what was the sense of " $(\exists n).3 + n = 7$ ", he would be answered "but you do know what this proposition says: $3 + 0 = 7$. $\vee 3 + 1 = 7$. $\vee 3 + 2 = 7$ and so on!" But to that one can reply "Quite correct--so the proposition isn't a logical sum, because a logical sum doesn't end with 'and so on'. What I am not clear about is this propositional form ' $\phi(0) \vee \phi(1) \vee \phi(2) \vee$ and so on'--and all you have done is to substitute a second unintelligible kind of proposition for the first one, while pretending to give me something familiar, namely a disjunction."

That is, if we believe that we do understand " $(\exists n)$ etc." in some absolute sense, we have in mind as a justification other uses of the notation " $(\exists \dots)$..." or of the ordinary-language expression "There is..." But to that one can only say: So you are *comparing* the proposition " $(\exists n)$..." with the proposition "There is a house in this city which..." or "There are two foreign words on this page". But the occurrence of the words "there is" in those sentences doesn't suffice to determine the grammar of this generalization, all it does is to indicate a certain analogy in the rules. And so we can still investigate the grammar of the generalisation " $(\exists n)$ etc." with an open mind, that is, without letting the meaning of " $(\exists \dots)$..." in other cases get in our way.

"Perhaps all numbers have the property ε ". Again the question is:

what is the grammar of this general proposition? Our being acquainted with the use of the expression "all..." in other grammatical systems is not enough. If we say "you do know what it means: it means $\varepsilon(0).\varepsilon(1).\varepsilon(2)$ and so on", again nothing is explained except that the proposition is *not* a logical product. In order to understand the grammar of the proposition we ask: how is the proposition used? What is regarded as the criterion of its truth? What is its verification?--If there is no method provided for deciding whether the proposition is true or false, then it is pointless, and that means senseless. But then we delude ourselves that there is indeed a method of verification, a method which cannot be employed, but only because of human weakness. This verification consists in checking all the (infinitely many) terms of the product $\varepsilon(0).\varepsilon(1).\varepsilon(2)$... Here there is confusion between physical impossibility and what is called 'logical impossibility'. For we think we have given sense to the expression "checking of the infinite product" because we take the expression "infinitely many" for the designation of an enormously large number. And when we hear of "the impossibility of checking the infinite number of propositions" there comes before our mind the impossibility of checking a very large number of propositions, say when we don't have sufficient time.

Remember that in the sense in which it is impossible to check an infinite number of propositions it is also impossible to try to do so.--If we are using the words "But you do know what 'all' means" to appeal to the cases in which this mode of speech is used, we cannot regard it as a matter of indifference if we observe a distinction between these cases and the case for which the use of the words is to be explained.--Of course we know what is meant by "checking a number of propositions for correctness", and it is this understanding that we are appealing to when we claim that one should understand also the expression "... infinitely many propositions". But doesn't the sense of the first expression depend on the specific experiences that correspond to it? And these experiences are lacking in the employment (the calculus) of the second expression; if any experiences at all are correlated to it they are fundamentally different ones.

Ramsey once proposed to express the proposition that infinitely many objects satisfied a function $f(\xi)$ by the denial of all propositions like

$\sim(\exists x).fx$
 $(\exists x).fx.\sim(\exists x, y).fx.fy$
 $(\exists x, y).fx.fy.\sim(\exists x, y, z).fx.fy.fz$
 and so on.

But this denial would yield the series

$(\exists x).fx$

$(\exists x, y).fx.fy$
 $(\exists x, y, z)...., etc., etc.$

Page 453

But this series too is quite superfluous: for in the first place the last proposition at any point surely contains all the previous ones, and secondly even it is of no use to us, because it isn't about an infinite number of objects. So in reality the series boils down to the proposition:

" $(\exists x, y, z... \text{ ad inf.}).fx.fy.fz... \text{ ad inf.}$ "

and we can't make anything of that sign unless we know its grammar. But one thing is clear: what we are dealing with isn't a sign of the form " $(\exists x, y, z).fx.fy.fz$ " but a sign whose similarity to that looks purposely deceptive.

Page 453

I can certainly define " $m > n$ " as $(\exists x):m - n = x$, but by doing so I haven't in any way analysed it. You think, that by using the symbolism " $(\exists...)...$ " you establish a connection between " $m > n$ " and other propositions of the form "there is... "; what you forget is that that can't do more than stress a certain analogy, because the sign " $(\exists...)...$ " is used in countless many different 'games'. (Just as there is a 'king' in chess and draughts.) So we have to know the rules governing its use *here*; and as soon as we do that it immediately becomes clear that these rules are connected with the rules for subtraction. For if

Page Break 454

we ask the usual question "how do I know--i.e. where do I get it from--that there is a number x that satisfies the condition $m - n = x$?" it is the rules for subtraction that provide the answer. And then we see that we haven't gained very much by our definition. Indeed we might just as well have given as an explanation of ' $m > n$ ' the rules for checking a proposition of that kind--e.g. ' $32 > 17$ '.

Page 454

If I say: "given any n there is a δ for which the function is less than n ", I am *ipso facto* referring to a general arithmetical criterion that indicates when $F(\delta) < n$.

Page 454

If in the nature of the case I cannot write down a number independently of a number system, that must be reflected in the general treatment of number. A number system is not something inferior--like a Russian abacus--that is only of interest to elementary schools while a more lofty general discussion can afford to disregard it.

Page 454

Again, I don't lose anything of the generality of my account if I give the rules that determine the correctness and incorrectness (and thus the sense) of ' $m > n$ ' for a particular system like the decimal system. After all I need *a* system, and the generality is preserved by giving the rules according to which one system can be translated into another.

Page 454

A proof in mathematics is general if it is generally applicable. You can't demand some other kind of generality in the name of rigour. *Every* proof rests on *particular* signs, produced on a particular occasion. All that can happen is that one type of generality may appear more elegant than another. ((Cf. the employment of the decimal system in proofs concerning δ and η)).

Page 454

"Rigorous" means: clear.†1

Page Break 455

"We may imagine a mathematical proposition as a creature which itself knows whether it is true or false (in contrast with propositions of experience).

Page 455

A mathematical proposition itself knows that it is true or that it is false. If it is about all numbers, it must also survey all the numbers. "Its truth or falsity must be contained in it as is its sense."

Page 455

"It's as though the generality of a proposition like ' $(n).\varepsilon(n)$ ' were only a pointer to the genuine, actual, mathematical generality, and not the generality itself. As if the proposition formed a sign only in a purely external way and you still needed to give the sign a sense from within."

Page 455

"We feel the generality possessed by the mathematical assertion to be different from the generality of the proposition proved."

"We could say: a mathematical proposition is an allusion to a proof."†1

What would it be like if a proposition itself did not quite grasp its sense? As if it were, so to speak, too grand for itself? That is really what logicians suppose.

A proposition that deals with all numbers cannot be thought of as verified by an endless striding, for, if the striding is endless, it does not lead to any goal.

Imagine an infinitely long row of trees, and, so that we can inspect them, a path beside them. All right, the path must be endless. But if it is endless, then that means precisely that you can't walk to the end of it. That is, it does *not* put me in a position to survey the row. That is to say, the endless path does not have an end 'infinitely far away', it has no end.

Nor can you say: "A proposition cannot deal with all the numbers one by one, so it has to deal with them by means of the concept of number" as if this were a *pis aller*: "Because we can't do it like *this*, we have to do it another way." But it is indeed possible to deal with the numbers one by one, only that *doesn't*

lead to the totality. That *doesn't* lie on the path on which we go step by step, not even at the infinitely distant end of that path. (This all only means that " $\epsilon(0).\epsilon(1).\epsilon(2)$ and so on" is not the sign for a logical product.)

"It cannot be a contingent matter that all numbers possess a property; if they do so it must be essential to them."--The proposition "men who have red noses are good-natured" does not have the same sense as the proposition "men who drink wine are goodnatured" even if the men who have red noses are the same as the men who drink wine. On the other hand, if the numbers m, n, o are the extension of a mathematical concept, so that is the case that $f_m.f_n.f_o$, then the proposition that the numbers that satisfy f have the property ϵ has the same sense as " $\epsilon(m).\epsilon(n).\epsilon(o)$ ". This is because the propositions " $f(m).f(n).f(o)$ " and " $\epsilon(m).\epsilon(n).\epsilon(o)$ " can be transformed into each other without leaving the realm of grammar.

Now consider the proposition: "all the n numbers that satisfy the condition $F(\xi)$ happen by chance to have the property ϵ ". Here what matters is whether the condition $F(\xi)$ is a mathematical one. If it is, then I can indeed derive $\epsilon(x)$ from $F(x)$, if only via the disjunction of the n values of $F(\xi)$. (For what we have in this case is in fact a disjunction). So I won't call this chance.--On the other hand if the condition is a non-mathematical one, we can speak of chance. For example, if I say: all the numbers I saw today on buses happened to prime numbers. (But, of course, we can't say: the numbers 17, 3, 5, 31 happen to be prime numbers" any more than "the number 3 happens to be a prime number"), "By chance" is indeed the opposite of "in accordance with a general rule", but however odd it sounds one can say that the proposition "17, 3, 5, 31 are prime numbers" is derivable by a general rule just like the proposition $2 + 3 = 5$.

If we now return to the first proposition, we may ask again: How is the proposition "all numbers have the property ϵ " supposed to be meant? How is one supposed to be able to know? For to settle its sense you must settle that too! The expression "by chance" indicates a verification by successive tests, and that is contradicted by the fact that we are not speaking of a finite series of numbers.

In mathematics description and object are equivalent. "The fifth number of the number series has these properties" says *the same* as "5 has these properties". The properties of a house do not *follow* from its position in a row of houses; but the properties of a number are the properties of a position.

You might say that the properties of a particular number cannot be foreseen. You can only see them when you've got there.

What is general is the repetition of an operation. Each stage of the repetition has its own individuality. But it isn't as if I use the operation to move from one individual to another so that the operation would be the means for

getting from one to the other--like a vehicle stopping at every number which we can then study: no, applying the operation $+ 1$ three times yields and *is* the number 3.

Page 457

(In the calculus process and result are equivalent to each other.)

Page 457

But before deciding to speak of "all these individualities" or "the totality of these individualities" I had to consider carefully what stipulations I wanted to make here for the use of the expressions "all" and "totality".

Page 457

It is difficult to extricate yourself completely from the extensional viewpoint: You keep thinking "Yes, but there must still be an internal relation between $x^3 + y^3$ and z^3 since at least extensions of these expressions if I only knew them would have to show the result of such a relation". Or perhaps: "It must surely be either *essential* to *all* numbers to have the property or not, even if I can't know it."

Page Break 458

Page 458

"If I run through the number series, I either eventually come to a number with the property ϵ or I never do." The expression "to run through the number series" is nonsense; unless a sense is *given* to it which removes the suggested analogy with "running through the numbers from 1 to 100".

Page 458

When Brouwer attacks the application of the law of excluded middle in mathematics, he is right in so far as he is directing his attack against a process analogous to the proof of empirical propositions. In mathematics you can never prove something like *this*: I saw two apples lying on the table, and now there is only *one* there, so A has eaten an apple. That is, you can't by excluding certain possibilities prove a new one which isn't already contained in the exclusion because of the rules we have laid down. To that extent there are no genuine alternatives in mathematics. If mathematics was the investigation of empirically given aggregates, one could use the exclusion of a part to describe what was not excluded, and in that case the non-excluded part would not be equivalent to the exclusion of the others.

Page 458

The whole approach that if a proposition is valid for one region of mathematics it need not necessarily be valid for a second region as well, is quite out of place in mathematics, completely contrary to its essence. Although many authors hold just this approach to be particularly subtle and to combat prejudice.

Page 458

It is only if you investigate the relevant propositions and their proofs that you can recognize the nature of the generality of the propositions of mathematics that treat not of "all cardinal numbers" but e.g. of "all real numbers".

Page 458

How a proposition is verified is what it says. Compare generality in arithmetic with the generality of non-arithmetical propositions.

Page Break 459

It is differently verified and so is of a different kind. The verification is not a mere token of the truth, but determines the sense of the proposition. (Einstein: how a magnitude is measured is what it is.)

Page Break 460

Page 460

A misleading picture: "The rational points lie close together on the number-line."

Page 460

Is a space thinkable that contains all rational points, but not the irrational ones? Would this structure be too coarse for our space, since it would mean that we could only reach the irrational points approximately? Would it mean that our net was not fine enough? No. What we would lack would be the laws, not the extensions.

Page 460

Is a space thinkable that contains all rational points but not the irrational ones?

Page 460

That only means: don't the rational numbers set a precedent for the irrational numbers?

Page 460

No more than draughts sets a precedent for chess.

There isn't any gap left open by the rational numbers that is filled up by the irrationals.

We are surprised to find that "between the everywhere dense rational points", there is still room for the irrationals. (What balderdash!) What does a construction like that for $\sqrt{2}$ show? Does it show how there is yet room for this point in between all the rational points? It shows that the point *yielded* by the construction, yielded by *this* construction, is *not rational*.--And what corresponds to this construction in arithmetic? A sort of number which manages *after all* to squeeze in between the rational numbers? A law that is not a law of the nature of a rational number.

The explanation of the Dedekind cut pretends to be clear when it says: there are 3 cases: either the class R has a first member and L no last member, etc. In fact two of these 3 cases cannot be imagined, unless the words "class", "first member", "last member", altogether change the everyday meanings they [[sic]] are supposed to have retained.

That is, if someone is dumbfounded by our talk of a class of points that lie to the right of a given point and have no beginning, and says: give us an example of such a class--we trot out the class of rational numbers; but that isn't a class of points in the original sense.

The point of intersection of two curves isn't the common member of two classes of points, it's the meeting of two laws. Unless, very misleadingly, we use the second form of expression to define the first.

After all I have already said, it may sound trivial if I now say that the mistake in the set-theoretical approach consists time and again in treating laws and enumerations (lists) as essentially the same kind of thing and arranging them in parallel series so that one fills in gaps left by another.

The symbol for a class is a list.

Here again, the difficulty arises from the formation of mathematical pseudo-concepts. For instance, when we say that we can arrange the cardinal numbers, but not the rational numbers, in a series according to their size, we are unconsciously presupposing that the concept of an ordering by size does have a sense *for rational numbers*, and that it turned out on investigation that the ordering was impossible (which presupposes that the *attempt* is thinkable).--Thus one thinks that it is possible to attempt to arrange *the real numbers* (as if that were a concept of the same kind as 'apple on this table') in a series, and now it turned out to be impracticable.

For its form of expression the calculus of sets relies as far as possible on the form of expression of the calculus of cardinal numbers. In some ways that is instructive, since it indicates certain formal similarities, but it is also misleading, like calling something a knife that has neither blade nor handle. (Lichtenberg.)

(The only point there can be to elegance in a mathematical proof is to reveal certain analogies in a particularly striking manner, when that is what is wanted; otherwise it is a product of stupidity and its only effect is to obscure what ought to be clear and manifest. The stupid pursuit of elegance is a principal cause of the mathematicians' failure to understand their own operations; or perhaps the lack of understanding and the pursuit of elegance have a common origin.)

Human beings are entangled all unknowing in the net of language.

"There is a point where the two curves intersect." How do you know that? If you tell me, I will know what sort of sense the proposition "there is..." has.

If you want to know what the expression "the maximum of a curve" means, ask yourself: how does one find it?--If something is found in a different way it is a different thing. We define the maximum as the point on the curve higher than all the others, and from that we get the idea that it is only our human weakness that prevents us from

sifting through the points of the curve one by one and selecting the highest of them. And this leads to the idea that the highest point among a finite number of points is essentially the same as the highest point of a curve, and that we are simply finding out the same thing by two different methods, just as we find out in two different ways that there is no one in the next room; one way if the door is shut and we aren't strong enough to open it, and another way if we can get inside. But, as I said, it isn't human weakness that's in question where the alleged description of the action "that we cannot perform" is senseless. Of course it does no harm, indeed it's very interesting, to see the analogy between the maximum of a curve and the maximum (in another sense) of a class of points, provided that the analogy doesn't instil the prejudice that in each case we have fundamentally the same thing.

Page Break 463

Page 463

It's the same defect in our syntax which presents the geometrical proposition "a length may be divided by a point into two parts" as a proposition of the same form as "a length may be divided for ever"; so that it looks as if in both cases we can say "Let's suppose the possible division to have been carried out". "Divisible into two parts" and "infinitely divisible" have quite different grammars. We mistakenly treat the word "infinite" as if it were a number word, because in everyday speech both are given as answers to the question "how many?"

Page 463

"But after all the maximum is higher than any other arbitrary points of the curve." But the curve is not composed of points, it is a law that points obey, or again, a law according to which points can be constructed. If you now ask: "which points?" I can only say, "well, for instance, the points P, Q, R, etc." On the one hand we can't give a number of points and say that they are all the points that lie on the curve, and on the other hand we can't speak of a totality of points as something describable which although we humans cannot count them might be called the totality of all the points of the curve--a totality too big for us human beings. On the one hand there is a law, and on the other points on the curve;--but not "all the points of the curve". The maximum is higher than any point of the curve that happens to be constructed, but it isn't higher than a totality of points, unless the criterion for that, and thus the sense of the assertion, is once again simply construction according to the law of the curve.

Page 463

Of course the web of errors in this region is a very complicated one. There is also e.g. the confusion between two different meanings of the word "kind". We admit, that is, that the infinite numbers are a different *kind* of number from the finite ones, but then we misunderstand what the difference between different kinds amounts to in this case. We don't realise, that is, that it's not a matter of distinguishing between objects by their properties in the way we distinguish between red and yellow apples, but a matter of different logical forms.--Thus Dedekind tried to *describe* an infinite class

Page Break 464

by saying that it is a class which is similar to a proper subclass of itself. Here it looks as if he has given a property that a class must have in order to fall under the concept "infinite class" (Frege).†1 Now let us consider how this definition is applied. I am to investigate in a particular case whether a class is finite or not, whether a certain row of trees, say, is finite or infinite. So, in accordance with the definition, I take a subclass of the row of trees and investigate whether it is similar (i.e. can be co-ordinated one-to-one) to the whole class! (Here already the whole thing has become laughable.) It hasn't any meaning; for, if I take a "finite class" as a sub-class, the attempt to coordinate it one-to-one with the whole class must *eo ipso* fail: and if I make the attempt with an infinite class--but already that is a piece of nonsense, for if it is infinite, I cannot make an attempt to co-ordinate it.--What we call 'correlation of all the members of a class with others' in the case of a finite class is something quite different from what we, e.g., call a correlation of all cardinal numbers with all rational numbers. The two correlations, or what one means by these words in the two cases, belong to different logical types. An infinite class is not a class which contains more members than a finite one, in the ordinary sense of the word "more". If we say that an infinite number is greater than a finite one, that doesn't make the two comparable, because in that statement the word "greater" *hasn't the same meaning* as it has say in the proposition $5 > 4$!

Page 464

That is to say, the definition pretends that whether a class is finite or infinite follows from the success or failure of the attempt to correlate a proper subclass with the whole class; whereas there just isn't any such decision procedure.--'Infinite class' and 'finite class' are different logical categories; what can be significantly

Page Break 465

asserted of the one category cannot be significantly asserted of the other.

With regard to finite classes the proposition that a class is not similar to its sub-classes is not a truth but a tautology. It is the grammatical rules for the generality of the general implication in the proposition "k is a subclass of K" that contain what is said by the proposition that K is an infinite class.

A proposition like "there is no last cardinal number" is offensive to naive--and correct--common sense. If I ask "Who was the last person in the procession?" and am told "There wasn't a last person" I don't know what to think; what does "There wasn't a last person" mean? Of course, if the question had been "Who was the standard bearer?" I would have understood the answer "There wasn't a standard bearer"; and of course the bewildering answer is modelled on an answer of that kind. That is, we feel, correctly, that where we can speak at all of a last one, there can't be "No last one". But of course that means: The proposition "There isn't a last one" should rather be: it makes no sense to speak of a "last cardinal number", that expression is ill-formed.

"Does the procession have an end?" might also mean: is the procession a compact group? And now someone might say: "There, you see, you can easily imagine a case of something not having an end; so why can't there be other such cases?"--But the answer is: The "cases" in this sense of the word are grammatical cases, and it is they that determine the sense of the question. The question "Why can't there be other such cases?" is modelled on: "Why can't there be other minerals that shine in the dark"; but the latter is about cases where a statement is true, the former about cases that determine the sense.

The form of expression " $m = 2n$ correlates a class with one of its proper subclasses" uses a misleading analogy to clothe a trivial sense in a paradoxical form. (And instead of being ashamed of

this paradoxical form as something ridiculous, people plume themselves on a victory over all prejudices of the understanding). It is exactly as if one changed the rules of chess and said it had been shown that chess could also be played quite differently. Thus we first mistake the word "number" for a concept word like "apple", then we talk of a "number of numbers" and we don't see that in this expression we shouldn't use the same word "number" twice; and finally we regard it as a discovery that the number of the even numbers is equal to the number of the odd and even numbers.

It is less misleading to say " $m = 2n$ allows the possibility of correlating every time with another" than to say " $m = 2n$ correlates all numbers with others". But here too the grammar of the meaning of the expression "possibility of correlation" has to be learnt.

(It's almost unbelievable, the way in which a problem gets completely barricaded in by the misleading expressions which generation upon generation throw up for miles around it, so that it becomes virtually impossible to get at it.)

If two arrows point in the same direction, isn't it in such a case absurd to call these directions equally *long*, because whatever lies in the direction of the one arrow, also lies in that of the other?--The generality of $m = 2n$ is an arrow that points along the series generated by the operation. And you can even say that the arrow points to infinity; but does that mean that there is something--infinity--at which it points, as at a thing?--It's as though the arrow designates the possibility of a position in its direction. But the word "possibility" is misleading, since someone will say: let what is possible now become actual. And in thinking this we always think of a temporal process, and infer from the fact that mathematics has nothing to do with time, that in its case possibility is already actuality.

The "infinite series of cardinal numbers" or "the concept of cardinal number" is only such a possibility--as emerges clearly

from the symbol " $|0, \xi, \xi + 1|$ ". This symbol is itself an arrow with the "0" as its tail and the " $\xi + 1$ " as its tip. It is possible to speak of things which lie in the direction of the arrow, but misleading or absurd to speak of all possible positions for things lying in the direction of the arrow as an equivalent for the arrow itself. If a searchlight sends out light into infinite space it illuminates everything in its direction, but you can't say it illuminates infinity.

It is always right to be extremely suspicious when proofs in mathematics are taken with greater generality

than is warranted by the known application of the proof. This is always a case of the mistake that sees general concepts and particular cases in mathematics. In set theory we meet this suspect generality at every step.

Page 467

One always feels like saying "let's get down to brass tacks".

Page 467

These general considerations only make sense when we have a particular region of application in mind.

Page 467

In mathematics there isn't any such thing as a generalization whose application to particular cases is still unforeseeable. That's why the general discussions of set theory (if they aren't viewed as *calculi*) always sound like empty chatter, and why we are always astounded when we are shown an application for them. We feel that what is going on isn't properly connected with real things.

Page 467

The distinction between the general truth that one can know, and the particular that one doesn't know, or between the known description of the object, and the object itself that one hasn't seen, is another example of something that has been taken over into logic from the physical description of the world. And that too is where we get the idea that our reason can recognize questions but not their answers.

Page Break 468

Page 468

Set theory attempts to grasp the infinite at a more general level than the investigation of the laws of the real numbers. It says that you can't grasp the actual infinite by means of mathematical symbolism at all and therefore it can only be described and not represented. The description would encompass it in something like the way in which you carry a number of things that you can't hold in your hand by packing them in a box. They are then invisible but we still know we are carrying them (so to speak, indirectly). One might say of this theory that it buys a pig in a poke. Let the infinite accommodate itself in this box as best it can.

Page 468

With this there goes too the idea that we can use language to *describe* logical forms. In a description of this sort the structures are presented in a package and so it does look as if one could speak of a structure without reproducing it in the proposition itself. Concepts which are packed up like this may, to be sure, be used, but our signs derive their meaning from definitions which package the concepts in this way; and if we follow up these definitions, the structures are uncovered again. (Cf. Russell's definition of "R*".)

Page 468

When "all apples" are spoken of, it isn't, so to speak, any concern of logic how many apples there are. With numbers it is different; logic is responsible for each and every one of them.

Page 468

Mathematics consists entirely of calculations.

Page 468

In mathematics *everything* is algorithm and *nothing* is meaning; even when it doesn't look like that because we seem to be using *words* to talk *about* mathematical things. Even these words are used to construct an algorithm.

Page 468

In set theory what is calculus must be separated off from what attempts to be (and of course cannot be) *theory*. The rules of the game have to be separated off from inessential statements about the chessmen.

Page 468

In Cantor's alleged definition of "greater", "smaller", "+", "-"

Page Break 469

Page 469

Frege replaced the signs with new words to show the definition wasn't really a definition.†1 Similarly in the whole of mathematics one might replace the usual words, especially the word "infinite" and its cognates, with entirely new and hitherto meaningless expressions so as to see what the calculus with these signs really achieves and what it fails to achieve. If the idea was widespread that chess gave us information about kings and castles, I would propose to give the pieces new shapes and different names, so as to demonstrate that everything belonging to chess has to be contained in the rules.

Page 469

What a geometrical proposition means, what kind of generality it has, is something that must show itself when we see how it is applied. For even if someone succeeded in meaning something intangible by it it wouldn't help him, because he can only apply it in a way which is quite open and intelligible to every one.

Similarly, if someone imagined the chess king as something mystical it wouldn't worry us since he can only move him on the 8×8 squares of the chess board.

We have a feeling "There can't be possibility and actuality in mathematics. It's all on *one* level. And is in a certain sense, *actual*.--And that is correct. For mathematics is a calculus; and the calculus does not say of any sign that it is merely *possible*, but is concerned only with the signs with which it *actually* operates. (Compare the foundations of set theory with the assumption of a possible calculus with infinite signs).

When set theory appeals to the human impossibility of a direct symbolisation of the infinite it brings in the crudest imaginable misinterpretation of its own calculus. It is of course this very misinterpretation that is responsible for the invention of the calculus. But of course that doesn't show the calculus in itself to

be something incorrect (it would be at worst uninteresting) and it is odd to believe that this part of mathematics is imperilled by any kind of philosophical (or mathematical) investigations. (As well say that chess might be imperilled by the discovery that wars between two armies do not follow the same course as battles on the chessboard.) What set theory has to lose is rather the atmosphere of clouds of thought surrounding the bare calculus, the suggestion of an underlying imaginary symbolism, a symbolism which isn't employed in its calculus, the apparent description of which is really nonsense. (In mathematics anything can be imagined, except for a part of our calculus.)

The extensional conception of the real numbers

Like the enigma of time for Augustine, the enigma of the continuum arises because language misleads us into applying to it a picture that doesn't fit. Set theory preserves the inappropriate picture of something discontinuous, but makes statements about it that contradict the picture, under the impression that it is breaking with prejudices; whereas what should really have been done is to point out that the picture just doesn't fit, that it certainly can't be stretched without being torn, and that instead of it one can use a new picture in certain respects similar to the old one.

The confusion in the concept of the "actual infinite" arises from the unclear concept of irrational number, that is, from the fact that logically very different things are called "irrational numbers" without any clear limits being given to the concept. The illusion that we have a firm concept rests on our belief that in signs of the the [sic] form "o.abcd... ad infinitum" we have a pattern to which they (the irrational numbers) have to conform whatever happens.

"Suppose I cut a length at a place where there is no rational point (no rational number)." But can you do that? What sort of a length are you speaking of? "But if my measuring instruments were fine enough, at least I could approximate without limit to a certain point by continued bisection"!--No, for I could never tell whether my point was a point of this kind. All I could tell would always be that I hadn't reached it. "But if I carry out the construction of $\sqrt{2}$ with absolutely exact drawing instruments, and then by bisection approximate to the point I get, I *know* that this process will never reach the constructed point." But it would be odd if one construction could as it were prescribe something to the others in this way! And indeed that isn't the way it is. It is very possible that

the point I get by means of the 'exact' construction of $\sqrt{2}$ is reached by the bisection after say 100 steps;--but in that case we could say: our space is not Euclidean.

The "cut at the irrational point" is a picture, and a misleading picture.

A cut is a *principle* of division into greater and smaller.

Does a cut through a length determine in advance the results of all bisections meant to approach the point of the cut? No.

In the previous example†1 in which I threw dice to guide me in the successive reduction of an interval by the bisection of a length I might just as well have thrown dice to guide me in the writing of a decimal. Thus the description "endless process of choosing between 1 and 0" does not determine a law in the writing of a decimal. Perhaps you feel like saying: the prescription for the endless choice between 0 and 1 in this case could be

reproduced by a symbol like " $0.\overset{000}{111} \dots$ ad. inf.". But if I adumbrate a law thus ' $0.001001001 \dots$ ad inf.', what I want to show is not the finite section of the series as a specimen of the infinite series, but rather the kind of regularity to be perceived in it. But in " $0.\overset{000}{111} \dots$ ad. inf." I don't perceive *any* law,--on the contrary, precisely that a law is absent.

Page 472

(What criterion is there for the irrational numbers being complete? Let us look at an irrational number: it runs through a series of rational approximations. When does it leave this series behind? Never. But then, the series also never comes to an end.

Page 472

Suppose we had the totality of all irrational numbers with one single exception. How would we feel the lack of this one? And--if

Page Break 473

it were to be added--how would it fill the gap? Suppose that it's π . If an irrational number is given through the totality of its approximations, then up to *any* point taken at random there is a series coinciding with that of π . Admittedly for each such series there is a point where they diverge. But this point can lie arbitrarily far 'out', so that for any series agreeing with π I can find one agreeing with it still further. And so if I have the totality of all irrational numbers except π , and now insert π I cannot cite a point at which π is now really needed. At *every* point it has a companion agreeing with it from the beginning on.

Page 473

To the question "how would we feel the lack of π " our answer must be "if π were an extension, we would never feel the lack of it". i.e. it would be impossible for us to observe a gap that it filled. But if someone asked us 'But have you then an infinite decimal expansion with the figure m in the r-th place and n in the s-th place, etc?' we could always oblige him.)

Page 473

"The decimal fractions developed in accordance with a law still need supplementing by an infinite set of irregular infinite decimal fractions that would be 'brushed under the carpet' if we were to *restrict* ourselves to those *generated by a law*." Where is there such an infinite decimal that is generated by no law? And how would we notice that it was missing? Where is the gap it is needed to fill?

Page 473

What is it like if someone so to speak checks the various laws for the construction of binary fractions by means of the set of finite combinations of the numerals 0 and 1?--The results of a law run through the finite combinations and hence the laws are complete as far as their extensions are concerned, once *all* the finite combinations have been gone through.

Page 473

If one says: two laws are identical in the case where they yield the same result at every stage, this looks like a quite general rule. But in reality the proposition has different senses depending on

Page Break 474

what is the criterion for their yielding the same result at every stage. (For of course there's no such thing as the supposed generally applicable method of infinite checking!) Thus under a mode of speaking derived from an analogy we conceal the most various meanings, and then believe that we have united the most various cases into a single system.

Page 474

(The laws corresponding to the irrational numbers all belong to the same type to the extent that they must all ultimately be recipes for the successive construction of decimal fractions. In a certain sense the common decimal notation gives rise to a common type.)

Page 474

We could also put it thus: *every* point in a length can be approximated to by *rational* numbers by repeated bisection. There is no point that can only be approximated to by irrational steps of a specified type. Of course, that is

only a way of clothing in different words the explanation that by irrational numbers we mean endless decimal fractions; and that explanation in turn is only a rough explanation of the decimal notation, plus perhaps an indication that we distinguish between laws that yield recurring decimals and laws that don't.

Page 474

The incorrect idea of the word "infinite" and of the role of "infinite expansion" in the arithmetic of the real numbers gives us the false notion that there is a uniform notation for irrational numbers (the notation of the infinite extension, e.g. of infinite decimal fractions).

Page 474

The proof that for every pair of cardinal numbers x and y $(x/y)^2 \neq 2$ does not correlate $\sqrt{2}$ with a *single* type of number--called "the irrational numbers". It is not as if this type of number was constructed before I construct it; in other words, I don't know any more about this new type of number than I tell myself.

Page Break 475

Kinds of irrational numbers

Page 475

π' is a rule for the formation of decimal fractions: the expansion of π' is the same as the expansion of π except where the sequence 777 occurs in the expansion of π ; in that case instead of the sequence 777 there occurs the sequence 000. There is no method known to our calculus of discovering where we encounter such a sequence in the expansion of π .

Page 475

P is a rule for the construction of binary fractions. At the n th place of the expansion there occurs a 1 or a 0 according to whether n is prime or not.

Page 475

F is a rule for the construction of binary fractions. At the n th place there is a 0 unless a triple x, y, z from the first 100 cardinal numbers satisfies the equation $x^n + y^n = z^n$.

Page 475

I'm tempted to say, the individual digits of the expansion (of π for example) are always only the results, the bark of the fully grown tree. What counts, or what something new can still grow from, is the inside of the trunk, where the tree's vital energy is. Altering the surface doesn't change the tree at all. To change it, you have to penetrate the trunk which is still living.

Page 475

I call " π_n " the expansion of π up to the n th place. Then I can say: I understand what π'_{100} means, but not what π' means, since π has no places, and I can't substitute others for none. It would be different if I e.g. defined the

division $\overset{5 \rightarrow 3}{a/b}$ as a rule for the formation of decimals by division and the replacements of every 5 in the quotient

by a 3. In this case I am acquainted, for instance, with the number $\overset{5 \rightarrow 3}{1/7}$. --And if our calculus contains a method, a law, to calculate the position of 777 in the expansion of π , then the law of π includes a mention of 777 and the law can be altered by the substitution of 000 for 777. But in that case π' isn't the same as what

Page Break 476

I defined above; it has a different grammar from the one I supposed. In our calculus there is no question whether π is π' or not, no such equation or inequality. π' is not comparable with π . And one can't say "not *yet* comparable", because if at some time I construct something similar to π' that is comparable to π , then for that very reason it will no longer be π' . For π' like π is a way of denoting a game, and I cannot say that draughts is not *yet* played with as many pieces as chess, on the grounds that it might develop into a game with 16 pieces. In that case it will no longer be what we call "draughts" (unless by this word I mean not a game, but a characteristic of several games or something similar; and this rider can be applied to π and π' too). But since being comparable with other numbers is a fundamental characteristic of a number, the question arises whether one is to call π' a number, and a real number; but whatever it is *called* the essential thing is that π' is not a number in the same sense as π . I can also call an interval a point and on occasion it may even be practical to do so; but does it become more like a point if I forget that I have used the word "point" with two different meanings?

Here it is clear that the possibility of the decimal expansion does not make π' a number in the same sense as π . Of course the rule for this expansion is unambiguous, as unambiguous as that for π or $\sqrt{2}$; but that is no proof that π' is a real number, if one takes comparability with rational numbers as an essential mark of real numbers. One can indeed abstract from the distinction between the rational and irrational numbers, but that does not make the distinction disappear. Of course, the fact that π' is an unambiguous rule for decimal fractions naturally signifies a similarity between π' and π or $\sqrt{2}$; but equally an interval has a similarity with a point etc. All the errors that have been made in this chapter of the philosophy of mathematics are based on the confusion between internal properties of a form (a rule as one among a list of rules) and what we call "properties" in everyday life (red as a property

of this book). We might also say: the contradictions and unclarities are brought about by people using a single word, e.g. "number", to mean at one time a definite set of rules, and at another time a variable set, like meaning by "chess" on one occasion the definite game we play today, and on another occasion the substratum of a particular historical development.

"How far must I expand π in order to have some acquaintance with it?"--Of course that is nonsense. We are already acquainted with it without expanding it at all. And in the same sense I might say that I am not acquainted with π' at all. Here it is quite clear that π' belongs to a different system from π ; that is something we recognize if we keep our eyes on the nature of the laws instead of comparing "the expansions" of both.

Two mathematical forms, of which one but not the other can be compared in my calculus with every rational number, are not numbers in the same sense of the word. The comparison of a number to a point on the number-line is valid only if we can say for every two numbers a and b whether a is to the right of b or b to the right of a.

It is not enough that someone should--supposedly--determine a point ever more closely by narrowing down its whereabouts. We must be able to construct *it*. To be sure, continued throwing of a die indefinitely restricts the possible whereabouts of a point, but it doesn't determine a point. After *every* throw (or every choice) the point is still infinitely indeterminate--or, more correctly, after every throw it is infinitely indeterminate. I think that we are here misled by the *absolute* size of the objects in our visual field; and on the other hand, by the ambiguity of the expression "to approach a point". We can say of a line in the visual field that by shrinking it is approximating more and more to a point--that is, it is becoming more and more similar to a point. On the other hand when a Euclidean line shrinks it does *not* become any more like a point; it always remains totally dissimilar, since its length, so to say,

never gets anywhere near a point. If we say of a Euclidean line that it is approximating to a point by shrinking, that only makes sense if there is an already designated point which its ends are approaching; it cannot mean that by shrinking it *produces* a point. To approach a point has two meanings: in one case it means to come spatially nearer to it, and in that case the point must already be there, because in this sense I cannot approach a man who doesn't exist; in the other case, it means "to become more like a point", as we say for instance that the apes as they developed approached the stage of being human, their development produced human beings.

To say "two real numbers are identical if their expansions coincide in *all* places" only has sense in the case in which, by producing a method of establishing the coincidence, I have *given* a sense to the expression "to coincide in all places". And the same naturally holds for the proposition "they do not coincide if they disagree in *any one* place".

But conversely couldn't one treat π' as the original, and therefore as the first assumed point, and then be in doubt about the justification of π ? As far as concerns their extension, they are naturally on the same level; but what causes us to call π a point on the number-line is its comparability with the rational numbers.

If I view π , or let's say $\sqrt{2}$, as a rule for the construction of decimals, I can naturally produce a modification of this rule by saying that every 7 in the development of $\sqrt{2}$ is to be replaced by a 5; but this modification is of quite a different *nature* from one which is produced by an alteration of the radicant or the exponent of the radical sign or the like. For instance, in the modified law I am including a reference to the number system of the expansion which wasn't in the original rule for $\sqrt{2}$. The alternation of the law is of a much more fundamental kind than might

at first appear.

Page Break 479

Of course, if we have the incorrect picture of the infinite extension before our minds, it can appear as if appending the substitution rule $7 \rightarrow 5$ to $\sqrt{2}$ alters it much less than altering $\sqrt{2}$ into $\sqrt{2 \cdot 1}$, because the expansions of $\sqrt{2}$ are very similar to those of $\sqrt{2}$, whereas the expansion of $\sqrt{2 \cdot 1}$ deviates from that of $\sqrt{2}$ from the second place onwards.

Page 479

Suppose I give a rule ρ for the formation of extensions in such a way that my calculus knows no way of predicting what is the maximum number of times an apparently recurring stretch of the extension can be repeated. That differs from a real number because in certain cases I can't compare $\rho - a$ with a rational number, so that the expression $\rho - a = b$ becomes nonsensical. If for instance the expansion of ρ so far known to me is $3 \cdot 14$ followed by an open series of ones ($3 \cdot 141111\dots$), it wouldn't be possible to say of the difference $\rho - 3 \cdot 14\bar{1}$ whether it was greater or less than 0; so in this sense it can't be compared with 0 or with a point on the number axis and it and ρ can't be called number in the same sense as one of these points.

Page 479

[The extension of a concept of number, or of the concept 'all', etc. seems quite harmless to us; but it stops being harmless as soon as we forget that we have in fact changed our concept.]

Page 479

[So far as concerns the irrational numbers, my investigation says only that it is incorrect (or misleading) to speak of irrational numbers in such a way as to contrast them with cardinal numbers and rational numbers as a different kind of number; because what are called "irrational numbers" are species of number that are really different--as different from each other as the rational numbers are different from each of them.]

Page 479

"Can God know all the places of the expansion of π ?" would have been a good question for the schoolmen to ask.

Page Break 480

Page 480

In these discussions we are always meeting something that could be called an "arithmetical experiment". Admittedly the data determine the result, but I can't see *in what way* they determine it. That is how it is with the occurrences of the 7s in the expansion of π ; the primes likewise are yielded as the result of an experiment. I can ascertain that 31 is a prime number, but I do not see the connection between it (its position in the series of cardinal numbers) and the condition it satisfies.--But this perplexity is only the consequence of an incorrect expression. The connection that I think I do not see does not exist. There is not an--as it were irregular--occurrence of 7s in the expansion of π , because there isn't any series that is called *the* expansion of π . There are expansions of π , namely those that have been worked out (perhaps 1000) and in those the 7s don't occur "irregularly" because their occurrence can be described. (The same goes for the "distribution of the primes". If you give as a law for this distribution, you give us a *new* number series, *new* numbers.) (A law of the calculus that I do not know is not a law.) (Only what I *see* is a law; not what I *describe*. That is the only thing standing in the way of my expressing more in my signs that I can understand.)

Page 480

Does it make no sense to say, even after Fermat's last theorem has been proved, that $F = 0 \cdot 11$? (If, say I were to read about it in the papers.) I will indeed then say, "so now we can write ' $F = 0 \cdot 11$ '." That is, it is tempting to adopt the sign "F" from the earlier calculus, in which it didn't denote a rational number, into the new one and now to denote $0 \cdot 11$ with it.

Page 480

F was supposed to be a number of which we did not know whether it was rational or irrational. Imagine a number, of which we do not know whether it is a cardinal number or a rational number. A description in the calculus is worth just as much as this particular set of words and it has nothing to do with an object given by description which may someday be found.

Page Break 481

Page 481

What I mean could also be expressed in the words: one cannot discover any connection between parts of mathematics or logic that was already there without one knowing.

Page 481

In mathematics there is no "not yet" and no "until further notice" (except in the sense in which we can say that we haven't yet multiplied two 1000 digit numbers together.)

Page 481

"Does the operation yield a rational number for instance?"--How can that be asked, if we have no method for deciding the question? For it is only in an established calculus that the operation *yields* results. I mean: "yields" is essentially timeless. It doesn't mean "yields, given time"--but: yields in accordance to the rules already known and established.

Page 481

"The position of all primes must somehow be predetermined. We work them out only successively, but they are all already determined. God, as it were, knows them all. And yet for all that it seems possible that they are not determined by a law."--Always this picture of the meaning of a word as a full box which is given us with its contents packed in it all ready for us to investigate.--What *do* we know about the prime numbers? How is the concept of them given to us at all? Don't we ourselves make the decisions about them? And how odd that we assume that there must have been decisions taken about them that we haven't taken ourselves! But the mistake is understandable. For we use the expression "prime number" and it sounds similar to "cardinal number", "square number", "even number" etc. So we think it will be used in the same way, and we forget that for the expression "prime number" we have given quite different rules--rules *different in kind*--and we find ourselves at odds with ourselves in a strange way.--But how is that possible? After all the prime numbers are familiar cardinal numbers--how can one say that the concept of prime number is not a number concept in the same sense as the concept of cardinal number? But here again we are tricked by the image of an "infinite extension" as an analogue to the familiar "finite "extension. Of course the concept 'prime number'

Page Break 482

is defined by means of the concept 'cardinal number', but "the prime numbers" aren't defined by means of "the cardinal numbers", and the way *we* derived the concept 'prime number' from the concept 'cardinal number' is essentially different from that in which we derived, say, the concept 'square number'. (So we cannot be surprised if it behaves differently.) One might well imagine an arithmetic which--as it were--didn't stop at the concept 'cardinal number' but went straight on to that of square numbers. (Of course that arithmetic couldn't be applied in the same way as ours.) But then the concept "square number" wouldn't have the characteristic it has in our arithmetic of being essentially a part-concept, with the square numbers essentially a sub-class of the cardinal numbers; in that case the square numbers would be a complete series with a complete arithmetic. And now imagine the same done with the prime numbers! That will make it clear that they are not "numbers" in the same sense as e.g. the square numbers or the cardinal numbers.

Page 482

Could the calculations of an engineer yield the result that the strength of a machine part in proportion to regularly increasing loads must increase in accordance with the series of primes?

Page Break 483

43

Irregular infinite decimals

Page 483

"Irregular infinite decimals". We always have the idea that we only have to bring together the words of our everyday language to give the combinations a sense, and all we then have to do is to inquire into it--supposing it's not quite clear right away. It is as if words were ingredients of a chemical compound, and we shook them together to make them combine with each other, and then had to investigate the properties of the compound, If someone said he didn't understand the expression "irregular infinite decimals" he would be told "that's not true, you understand it very well: don't you know what the words "irregular", "infinite", and "decimal" mean?--well, then, you understand their combination as well." And what is meant by "understanding" here is that he knows how to apply these words in certain cases, and say *connects an image with them*. In fact, someone who puts these words together and asks "what does it mean" is behaving rather like small children who cover a paper with random scribbles, show it to grown-ups, and ask "what is that?"

Page 483

"Infinitely complicated law", "infinitely complicated construction" ("Human beings believe, if only they hear words, there must be something that can be thought with them").

How does an infinitely complicated law differ from the lack of any law?

(Let us not forget: mathematicians' discussions of the infinite are clearly finite discussions. By which I mean, they come to an end.)

"One can imagine an irregular infinite decimal being constructed by endless dicing, with the number of pips in each case being a decimal place." But, if the dicing goes on for ever, no final result ever comes out.

"It is only the human intellect that is incapable of grasping it, a higher intellect could do so!" Fine, then describe to me the grammar of the expression "higher intellect"; what can such an intellect grasp and what can't it grasp and in what cases (in experience) do I say that an intellect grasps something? You will then see that describing grasping is itself grasping. (Compare: the solution of a mathematical problem.)

Suppose we throw a coin heads and tails and divide an interval AB in accordance with the following rule: "Heads" means: take the left half and divide it in the way the next throw prescribes. "Tails" says "take the right half, etc." By repeated throws I then

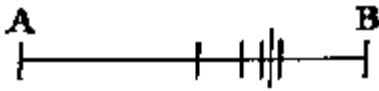

get dividing-points that move in an ever smaller interval. Does it amount to a description of the position of a point if I say that it is the one infinitely approached by the cuts as prescribed by the repeated tossing of the coin? Here one believes oneself to have determined a point corresponding to an irregular infinite decimal. But the description doesn't determine *any* point *explicitly*; unless one says that the words "point on this line" also "determine a point"! Here we are confusing the recipe for throwing with a mathematical rule like that for producing decimal places of $\sqrt{2}$. Those mathematical rules *are* the points. That is, you can find relations between those rules that resemble in their grammar the relations "larger" and "smaller" between two lengths, and that is why they are referred to by these words. The rule for working out places of $\sqrt{2}$ is itself the numeral for the irrational number; and the reason I here speak of a "number" is that I can calculate with these signs (certain rules for the construction of rational numbers) just as I can with rational numbers themselves. If I want to say similarly

that the recipe for endless bisection according to heads and tails determines a point, that would have to mean that this recipe could be used as a numeral, i.e. in the same way as other numerals. But of course that is not the case. If the recipe were to correspond to a numeral at all, it would at best correspond to the indeterminate numeral "some", for all it does is to leave a number open. In a word, it corresponds to nothing except the original interval.

Note in Editing

In June 1931 Wittgenstein wrote a parenthesis in his manuscript book: "(My book might be called: Philosophical Grammar. This title would no doubt have the smell of a textbook title but that doesn't matter, for behind it there is the book.)" In the next four manuscript volumes after this he wrote nearly everything that is in the present work. The second of these he called "Remarks towards Philosophical Grammar" and the last two "Philosophical Grammar".

The most important source for our text is a large typescript completed probably in 1933, perhaps some of it 1932. Our "Part II" makes up roughly the second half of this typescript. In most of the first half of it Wittgenstein made repeated changes and revisions--between the lines and on the reverse sides of the typed sheets--and probably in the summer of 1933 he began a "Revision" in a manuscript volume (X and going over into XI). This, with the "Second Revision" (which I will explain), is the text of our Part I up to the Appendix.--Wittgenstein simply wrote "*Umarbeitung*" (Revision) as a heading, without a date; but he clearly wrote it in 1933 and the early weeks of 1934.

He did not write the "second revision" in the manuscript volume but on large folio sheets. He He crossed out the text that this was to replace, and showed in margins which parts went where. But it is a revision of only a *part*, towards the beginning, of the first and principal "Revision". The passages from the second revision are, in our text, §§1-13 and §§ 23-43. The second revision is not dated either, but obviously it is later than the passages it replaces; probably not later than 1934.

Page 487

So we may take it that he wrote part of this work somewhat earlier, and part at the same time as his dictation of *The Blue Book*. Many things in the *Blue Book* are here (and they are better expressed). There are passages also which are in the *Philosophical Remarks* and others later included in the *Investigations*. It would be easy to give the reference and page number for each of these. We decided not to. This book should be compared with Wittgenstein's earlier and later writings. But this means: the method and the development

Page Break 488

of his discussion here should be compared with the *Philosophical Remarks* and again with the *Investigations*. The footnotes would be a hindrance and, as often as not, misleading. When Wittgenstein writes a paragraph here that is also in the *Remarks*, this does not mean that he is just repeating what he said there. The paragraph may have a different importance, it may belong to the discussion in a different way. (We know there is more to be said on this question.)

Page 488

Wittgenstein refers to "my book" at various times in his manuscripts from the start of 1929 until the latest passages of the *Investigations*. It is what his writing was to produce. The first attempt to form the material into a book was the typescript volume he made in the summer of 1930--the *Philosophical Remarks* (published in German in 1964). The large typescript of 1933--the one we mentioned as a source of this volume--looks like a book. Everyone who sees it first thinks it is. But it is unfinished; in a great many ways. And Wittgenstein evidently looked on it as one stage in the ordering of his material. (Cf. the simile of arranging books on the shelves of a library, in *Blue Book* p. 44-45.)

Page 488

Most of the passages which make up the text of the 1933 typescript (called "213" in the catalogue) he had written in manuscript volumes between July 1930 and July 1932; but not in the order they have in the typescript. From the manuscript volumes he dictated two typescripts, one fairly short and the other much longer--about 850 pages together. There was already a typescript made from manuscripts written *before* July 1930--not the typescript which *was* the *Philosophical Remarks* but a typescript which he cut into parts and sifted and put together in a different way to *make* the *Philosophical Remarks*. He now used an intact copy of this typescript together with the two later ones in the same way, cutting them into strips: small strips sometimes with just one paragraph or one sentence, sometimes groups of paragraphs; and arranging them in the order he saw they ought to have. Groups of slips in their order were clipped together to form 'chapters', and he gave each chapter a title. He then brought the chapters together--in a definite order--to form 'sections'. He gave each section a title and arranged them also in a definite order. In this order the whole was finally typed.--Later he made a table of contents out of the titles of sections and chapter headings.

Page Break 489

Page 489

Certain chapters, especially, leave one feeling that he cannot have thought the typing of the consecutive copy had finished the work barring clerical details. He now wrote, over and over again, between the lines of typescript or in the margin: "Does not belong here", "Belongs on page... above", "Belongs to 'Meaning', § 9", "Goes with 'What is an empirical proposition?'" "Belongs with § 14, p. 58 or § 89 p. 414", and so on. But more than this, about 350 pages--most of the first half of the typescript--are so written over with changes, additions, cancellations, questions and new versions, that no one could ever find the 'correct' text here and copy it--saving the author himself should write it over to include newer versions and make everything shorter.

Page 489

He now makes no division into chapters and sections. He has left out paragraph numbers and any suggestion of a table of contents. We do not know why. (We do not find chapters or tables of contents anywhere else in Wittgenstein's writings. He may have found disadvantages in the experiment he tried here.)--The extra spaces between paragraphs and groups of paragraphs are his own; and he thought these important. He would have numbered paragraphs, probably, as he did in the *Investigations*. But the numbers in Part I here are the editor's, not Wittgenstein's. Neither is the division in chapters Wittgenstein's, nor the table of contents.--On the other hand, Part II has kept the chapters and the table of contents which Wittgenstein gave this part of the typescript. Perhaps this

makes it look as though Part I and Part II were not one work. But we could not make them uniform in this (division and arrangement of chapters) without moving away from Wittgenstein's way of presenting what he wrote. Anyone who reads both parts will see connections.

Page 489

And the appendix may make it plainer. Appendices 5, 6, 7, 8 and the first half of 4 are chapters of 'typescript 213'. Appendix I, *Fact and Complex*, is also an appendix in *Philosophical Remarks*. But Wittgenstein had fastened it together with appendices 2 and 3 and given them a consecutive paging as one essay; with what intention we do not know. Each one of the eight appendices here discusses something connected with 'proposition' and with 'sense of a proposition'. The whole standpoint is somewhat earlier (the manuscripts often bear earlier dates) than that of

Page Break 490

Part I here, but later than the *Philosophical Remarks*.--But the appendices also discuss questions directly connected with the themes of 'generality' and 'logical inference' in Part II.

Page 490

Part I is concerned with the generality of certain expressions or concepts, such as 'language', 'proposition' and 'number'. For instance, § 70, page 113:

Page 490

"Compare the concept of proposition with the concept 'number' and then on the other hand with the concept of cardinal number. We count as numbers cardinal numbers, rational numbers, irrational numbers, complex numbers; whether we call other constructions numbers because of their similarities with these, or draw a definitive boundary here or elsewhere, depends on us. In this respect the concept of number is like the concept of proposition. On the other hand the concept of cardinal number $|1, \xi, \xi + 1|$ can be called a rigorously circumscribed concept, that's to say it's a concept in a different sense of the word."

Page 490

This discussion is closely related to the chapter on '*Kinds of Cardinal Numbers*' and on ' $2 + 2 = 4$ ' in Part II; and with the section on *Inductive Proof*. These are the most important things in Part II.

London, 1969

Page 490

Page Break 491

Translator's Note

Page 491

Many passages in the *Philosophical Grammar* appear also in the *Philosophical Remarks*, the *Philosophical Investigations*, and the *Zettel*. In these cases I have used the translations of Mr Roger White and Professor G. E. M. Anscombe, so that variations between the styles of translators should not be mistaken for changes of mind on Wittgenstein's part. Rare departures from this practice are marked in footnotes. Passages from the *Philosophical Grammar* appear also in *The Principles of Linguistic Philosophy* of F. Waismann (Macmillan 1965): in these cases I have not felt obliged to follow the English text verbatim, but I am indebted to Waismann's translator.

Page 491

Three words or groups of words constantly presented difficulties in translation.

Page 491

The German word "*Satz*" may be translated "proposition" or "sentence" or (in mathematical and logical contexts) "theorem". I have tried to follow what appears to have been Wittgenstein's own practice when writing English, by using the word "proposition" when the syntactical or semantic properties of sentences were in question, and the word "sentence" when it was a matter of the physical properties of sounds or marks. But it would be idle to pretend that this rule provides a clear decision in every case, and sometimes I have been obliged to draw attention in footnotes to problems presented by the German word.

Page 491

From the *Tractatus* onward Wittgenstein frequently compared a proposition to a *Maßstab*. The German word means a rule or measuring rod: when Wittgenstein used it is clear that he had in mind a rigid object with calibrations. Finding the word "rule" too ambiguous, and the word "measuring-rod" too cumbersome, I have followed the translators of the *Tractatus* in using the less accurate but more natural word "ruler".

Page 491

Translators of Wittgenstein have been criticised for failing to adopt a uniform translation of the word "*übersehen*" and its derivatives, given the importance of the notion of "*übersichtliche Darstellung*" in Wittgenstein's later conception of philosophy. I have

Page Break 492

been unable to find a natural word to meet the requirement of uniformity, and have translated the word and its cognates as seemed natural in each context.

Page 492

Like other translators of Wittgenstein I have been forced to retain a rather Germanic style of punctuation to avoid departing too far from the original. For instance, Wittgenstein often introduced *oratio recta* by a colon instead of by inverted commas. This is not natural in English, but to change to inverted commas would involve making a decision--often a disputable one--about where the quotation is intended to end.

Page 492

I have translated the text of the Suhrkamp-Blackwell edition of 1969 as it stands, with the exception of the passages listed below in which I took the opportunity to correct in translation errors of transcription or printing which had crept into the German text. The pagination of the translation, so far as practicable, matches that of the original edition.

Page 492

I am greatly indebted to Professor Ernst Tugendhat, who assisted me in the first draft of my translation; and to Mr John Thomas, Dr Peter Hacker, Mr Brian McGuinness, Professor G. E. M. Anscombe, Professor Norman Malcolm, Professor G. H. von Wright, Mr Roger White, Dr Anselm Müller, Mr and Mrs J. Tiles and Mr R. Heinaman who assisted me on particular points. My greatest debt is to Mr Rush Rhees, who went very carefully through large sections of a draft version and saved me from many errors while improving the translation in many ways. The responsibility for remaining errors is entirely mine.

Page 492

I am grateful to the British Academy for a Visiting Fellowship which supported me while writing the first draft translation.

Oxford 1973

Page 492

Page Break 493

Corrections to the 1969 German Edition

Page 493

page 17 line 31 For "Gedanken" read "Gedanke".

Page 493

24 15 For "selten" read "seltsam".

Page 493

25 17 For "Vom Befehl" read "Von der Erwartung".

Page 493

43 23 For "Carroll's" read "Carroll's Gedicht".

Page 493

44 15 For "was besagt" read "was sagt".

Page 493

52 13 For "uns da" read "uns da etwas".

Page 493

52 27 For "geben" read "ergeben".

Page 493

61 22 For "kann" read "kann nun".

Page 493

72 4 There should be no space between the paragraphs.

Page 493

75 28 For "übergrenzt" read "überkreuzt".

Page 493

88 9 For "gezeichnet haben" read "bezeichnet haben, sie schon zur Taufe gehalten haben".

Page 493

92 27 For "nun" read "nun nicht".

Page 493

97 7 For "Jedem" read "jedem".

Page 493

107 5 For "sie" read "sie von".

Page 493

108 17 For "Körperlos" read "körperlos".

Page 493

- 119 8 For "nun" read "um".
Page 493
- 123 16 There should be no space between the paragraphs.
Page 493
- 147 21 For "daß" read "das".
Page 493
- 148 1 For "Zeichen" read "Zeichnen".
Page 493
- 151 21 For "schreibt" read "beschreibt".
Page 493
- 152 19 For "Auszahlungen" read "Auszahlungen".
Page 493
- 152 30 For "hervorgerufen" read "hervorzurufen".
Page 493
- 160 21 There should be a space between the paragraphs.
Page 493
- 160 15 For "Ciffre" read "Chiffre".
Page 493
- 163 30 There should be no space between the paragraphs.
Page 493
- 171 12 For "systematischen" read "schematischen".
Page 493
- 178 3 For "lügen:" read "lügen".
Page 493
- 205 9 For "in der" read "der".
Page 493
- 215 3 For "Buches" read "Buches uns".
Page 493
- 221 8 For "Erkenntis" read "Erkenntnis".
Page Break 494
- Page 494
- page 244 line 20 For "folgen" read "Folgen".
Page 494
- 244 23 For "etwa" read "es dazu".
Page 494
- 244 24 For "den" read "dem".
Page 494
- 245 19 For "fy" read "fx".
Page 494
- 251 12 For "dem" read "den".
Page 494
- 251 13 For "mit" read "mir".
Page 494
- 253 The "t1" in the figure is misplaced.
Page 494
- 256 23 For "folge" read "folgte".
Page 494
- 260 23 For "weh" read "nicht weh".
Page 494
- 261 12 For "ist" read "ist da".
Page 494
- 268 1ff For 'f' read 'ϕ' *passim*.
Page 494
- 278 31 For "Fall von $f(\exists)$ ist," read "Fall von $f(\exists)$ ist. Und nun kann mans uns entgegenhalten: Wenn er sieht, dass $f(a)$ ein Fall von $f(\exists)$ ist,"
Page 494

- 286 6 For "0.3" read "0.3̇".
- Page 494
- 288 11 For "1 + 1 + 1 + 1" read "1 + 1 + 1 + 1 + 1".
- Page 494
- 288 30 For " ψx " read " ϕx ".
- Page 494
- 292 5 For "wird" read "wird. Vom Kind nur die richtige Ausführung der Multiplikation verlangt wird".
- Page 494
- 294 13 For "uns" read "nun uns".
- Page 494
- 296 12 For "Ich habe gesagt" read "Ich sagte oben".
- Page 494
- 305 12 Insert new paragraph: "Wenn nachträglich ein Widerspruch gefunden wird, so waren vorher die Regeln noch nicht klar und eindeutig. Der Widerspruch macht also nichts denn er ist dann durch das Aussprechen einer Regel zu entfernen."
- Page 494
- 313 8 For "Hiweisen" read "Hinweisen".
- Page 494
- 316 21 For "unnötiges Zeichen für "Taut." geben" read "unnötiges--Zeichen für "Taut." gegeben".
- Page 494
- 317 6 For "den" read "dem".
- Page 494
- 317 15 For "Def." read " **Def** = ".
- Page 494
- 317 29 For "Sätze)." read "Sätze) und zwar eine richtige degenerierte Gleichung (den Grenzfall einer Gleichung)."
- Page 494
- 325 21 For "könne" read "könnte".
- Page Break 495
- Page 495
- page 325 line 27 For "nenne" read "nennen".
- Page 495
- 328 9 For "Schma" read "Schema".
- Page 495
- 344 1 For "(x" read "(E x".
- Page 495
- 344 9 For "(x)" read "(E x)".
- Page 495
- 353 2 For "Cont." read "Kont."
- Page 495
- 353 13 For "(\exists)" read "($\exists n$)".
- Page 495
- 383 22 For "nur" read "nun".
- Page 495
- 386 13 For "3n" read "3n²".
- Page 495
- 388 11 For "the" read "der".
- Page 495
- 393 13 For "keine" read "eine".
- Page 495
- 393 27 For "Schreibmaschine" read "Schreibweise".
- Page 495
- 398 25 For "1:2" read " **1 : 2** \bigcirc ".

- Page 495
405 1 Seventh to tenth words of title should be roman.
- Page 495
405 5 For "die Kardinalzahlen" read "alle Kardinalzahlen".
- Page 495
411 fn2 For "→" read "S.414".
- Page 495
415 27 For "können." read "können. Niemand aber würde sie in diesem Spiel einen Beweis gennant haben!".
- Page 495
416 fn4 For "(b + 1" read "(b + 1)".
- Page 495
431 20 For "((4 + 1) + 1" read "((4 + 1) + 1)".
- Page 495
441 16 For "gesehn" read "gesehen".
- Page 495
441 33 For "ρ||" read "ρ".
- Page 495
451 4 For "3n + 7" read "3 + n = 7".
- Page 495
453 32 For "(...)" read "(...)".
- Page 495
456 35 For "Kann nicht" read "kann".
- Page 495
460 7 For "könnten?" read "könnten? Unser Netz wäre also nicht fein genug?".
- Page 495
461 13 For "listen" read "Listen".
- Page 495
465 28 For "andere Mineralien" read "auch andere Fälle".
- Page 495
471 29 For "erhöhten" read "erhaltenen".
- Page 495
472 19 The symbol should read: " $\circ, \overset{\circ}{111}, \dots$ ".
- Page 495
481 27 For "Quadratzahlen", gerade Zahlen" read ""Quadratzehlen", "gerade Zahlen".
- Page 495
481 30 For "primzahl" read "Primzahl".

FOOTNOTES

- Page 56
†1. Sophist, 261E, 262A. [I have replaced "kinds of word" which appears in the translation of the parallel passages in *Philosophical Investigations* § 1 with "parts of speech", which appears to have been Wittgenstein's preferred translation. I am indebted for this information to Mr. R. Rhees. Trs.]
- Page 78
†1. Cf. p. 165f (Ed.)
- Page 106
†1. The parallel passage in *Zettel* 606 is translated in a way that does not fit this context (Trs.)
- Page 111
†1. Cf. p. 94
- Page 112
†1. The same German word corresponds to "sentence" as to "proposition" (Tr.)
- Page 128
†1. Cf. *Philosophical Investigations* § 521 (Ed.)
- Page 137

†1. Plato: Theaetetus 189A. (I have translated Wittgenstein's German rather than the Greek original. Trs.)

Page 140

†1. A line has dropped out of the translation of the corresponding passage in *Zettel* (§63).

Page 141

†1. Philebus, 40A. (The Greek word in the context means rather "a word", "a proposition". Tr.)

Page 156

†1. p. 143 above.

Page 164

†1. Theaetetus, 189A (immediately before the passage quoted in §90).

Page 177

†1. Cf. *Philosophical Investigations*, I, §537 (Trs.)

Page 182

†1. [Earlier draft of the parenthesis]. (Something very similar to this is the problem of the nature and flow of time).

Page 184

†1. In pencil in the MS: [Perhaps apropos of the paradox that mathematics consists of rules.]

Page 185

†1. A tells B that he has hit the jackpot in the lottery; he saw a box lying in the street with the numbers 5 and 7 on it. He worked out that $5 \times 7 = 64$ --and took the number 64.

Page 185

B: But 5×7 isn't 64!

Page 185

A: I've hit the jackpot and he wants to give me lessons!

Page 202

†1. There appears to be something wrong with the German text here. Possibly Wittgenstein meant to write "let this man be called 'N'" and inadvertently wrote a version which is the same as the one he is correcting. (Trs.)

Page 205

†1. I have here corrected an inadvertent transposition of "I" and "II" in Wittgenstein's German. (Trs.)

Page 210

†1. From the 1932(?) typescript where it appears as a chapter by itself.

Page 211

†1. From a later MS note book, probably written in summer 1936, some two years after the main text of this volume.

Page 212

†1. Cf. p. 163.

Page 213

†1. Cf. Tractatus 2. 1513 (Editor).

Page 246

†1. Cf. Tractatus 5. 132 (Ed.).

Page 288

†1. Perhaps Wittgenstein inadvertently omitted a negation sign before the second quantifier. (Trs.)

Page 296

†1. According to Dr. C. Lewy Wittgenstein wrote in the margin of F. P. Ramsey's copy of the *Tractatus* at 6.02: "Number is *the* fundamental idea of calculus and must be introduced as such." This was, Lewy thinks, in the year 1923. See *Mind*, July 1967, p. 422.

Page 308

†1. *Philosophical Remarks*, p. 119.

Page 315

†1. F. P. Ramsey, *The Foundations of Mathematics*, London 1931, p. 53.

Page 319

†1. The section does not mention arithmetic. It may be conjectured that it was never completed. (Ed.)

Page 325

†1. This is an allusion to the German academic custom of announcing a lecture for, say, 11.15 by scheduling it "11.00 c.t." (Trs.)

Page 339

†1. For the explanation of this notation, see below, p. 343 f.

Page 340

†1. In the manuscript this paragraph is preceded by the remark: I can work out $17 + 28$ according to the rules, I don't need to give $17 + 28 = 45$ (α) as a rule. So if in a proof there occurs the step from $f(17 + 28)$ to $f(45)$ I don't need to say it took place according to (α); I can cite other rules of the addition table.

Page 340

But what is this like in the $((((1) + 1) + 1) + 1)$ notation? Can I say I could work out e.g. $2 + 3$ in it? And according to which rules? It would go like this:

Page 340

$$\{(1) + 1\} + \{((1) + 1) + 1\} = \{((1) + 1) + 1\} = \{(((1) + 1) + 1) + 1\} \dots \sigma$$

Page 347

†1. Thus according to the typescript. The manuscript reads " $(\exists 3x).\phi x.(\exists 2x).\psi x.$ Ind.: $\supset.(\exists 5x).\phi x \vee \psi x$ ".

Page 364

†1. This paragraph is crossed out in the typescript.

Page 380

†1. Perhaps the problem is to find the number of ways in which we can trace the joins in this wall without interruption, omission or repetition. Cf. *Remarks on the Foundations of Mathematics* p. 174.

Page 383

†1. Here and at one point further down, I have corrected a confusion in Wittgenstein's typescript between "left" and "right" (Tr.).

Page 389

†1. p. 321.

Page 397

†1. *Begründung der Elementaren Arithmetik* von Th. Skolem, Skrifter utg. av. Vid.-Selsk i Kristiana 1923. I Mat.-nat. K. No. 6. p. 5. Translated in van Heijenoort, *From Frege to Gödel*, Harvard University Press, 1967, pp. 302-333.

Page 398

†1. The dash underneath emphasizes that the remainder is equal to the dividend. So the expression becomes the symbol for periodic division. (Ed.)

Page 401

†1. $? (x).\phi x.$ (Ed.)

Page 406

†1. Above, p. 397.

Page 408

†1. See the appendix on p. 446. Cf. also *Philosophical Remarks*, p. 194 n.

Page 411

†1. "The schema ρ "--or: the group of equations α , β and γ on p. 397. A little further on Wittgenstein refers to the same group as "R", p. 414 below. Later on p. 433, he speaks again of "the rule R" as here on p. 408, where it is: $a + (b + 1) = (a + b) + 1$. (Ed.)

Page 411

†2. This, probably, refers to those equations on p. 408 to the right of the brackets, that is: $a + (b + c) = (a + b) + c$, $a + 1 = 1 + a$, $a + b = b + a$. $B_I, B_{II}, B_{III} \dots$ will then be the complexes of equations left of the brackets. On the meaning of the brackets, see below (Ed.)

Page 416

†1. "V" denotes a definition which will be given below, p. 441. In the manuscript that passage comes somewhat earlier than the remark above. The passage runs: "And if we now settle by definition:

$$\begin{aligned} & [a + (b + 1) \stackrel{\alpha}{=} (a + b) + 1] \ \& \ [a + (b + (c + 1)) \stackrel{\beta}{=} (a + (b + c)) + 1] \ \& \\ & \& \ [(a + b) + (c + 1) \stackrel{\gamma}{=} \\ & = ((a + b) + c) + 1]. \stackrel{\text{Def}}{=} a + (b + c). \mathfrak{S}. (a + b) + c \dots U) \\ & \text{and in general: } [f_1(1) \stackrel{\rho}{=} f_2(1)] \ \& \ [f_1(c + 1) \stackrel{\beta}{=} f_1(c) + 1] \ \& \\ & \& \ [f_2(c + 1) \stackrel{\gamma}{=} f_2(c) + 1]. \stackrel{\text{Def}}{=} (f_1(c). \mathfrak{S}. f_2(c) \dots V)'' \end{aligned}$$

" \mathfrak{S} " is mentioned in the context below. V here is a definition of \mathfrak{S}). (Ed.)

Page 418

†1. The schema R above, p. 414. In the manuscript shortly after this schema there follows the remark:

"I have put a bracket } between α , β , γ and A, as if it was self-evident what this bracket meant. One might conjecture that the bracket meant the same as an equals sign. Such a bracket, incidentally, might be put

between " $1 \cdot 0/3 = 0 \cdot 3$ " and " $1 : 3 = 0 \cdot 3$ ".

Page 419

†1. Earlier version:... the question "is that too right?"

Page 420

†1. See below, p. 426.

Page 420

†2. Compare the form of the rule R on p. 433 below. In the manuscript Wittgenstein introduced this formulation thus: "Perhaps the matter will become clearer, if we give the following rule for addition instead of the recursive rule 'a + (b + 1) = (a + b) + 1'

$$\begin{aligned}
 a + (1 + 1) &= (a + 1) + 1 \\
 a + (1 + 1) + 1 &= ((a + 1) + 1) + 1 \text{ [[sic, missing (]]} \\
 a + (((1 + 1) + 1) + 1) &= (((a + 1) + 1) + 1) + 1 \\
 &\dots \text{ etc....}
 \end{aligned}$$

Footnote Page Break 421

$$\left| \begin{array}{ccc}
 a + (a + 1) = (a + 1) + 1 & & \\
 \downarrow & & \downarrow \\
 a + (\xi + 1) & (a + \xi) + 1 & \\
 a + ((\xi + 1) + 1) & ((a + \xi) + 1) + 1 &
 \end{array} \right| \mathbf{R}$$

We write this rule in the form, |1, ξ , $\xi + 1$ | thus
 In the application of the rule R... a ranges over the series |1, ξ , $\xi + 1$ |."

Page 421

He then says of *this* rule that it can be written also in the form S or in the form a + (b + 1) = (a + b) + 1.

Page 433

†1. Cf. footnote, p. 420.

Page 439

†1. The schema R as above on p. 414. Cf B on p. 397. (Ed.)

Page 440

†1. Cf. perhaps: *Grundgesetze der Arithmetik*, II, p. 114, 115 §§ 107, 108. Waismann cited excerpts from these §§. (*Wittgenstein und der Wiener Kreis*, pp. 150-151). Cf here Wittgenstein's remarks on them (*ibid.* pp. 151-157). (Ed.)

Page 446

†1. Remarks taken from the Manuscript volume. We must not forget that Wittgenstein omitted them. Even in the MS they are not set out together as they are here. (Ed.)

Page 448

†1. Above, p. 431.

Page 449

†1. To repeat, α is: a + (b + 1) = (a + b) + 1

A is: a + (b + c) = (a + b) + c. (Ed.)

Page 454

†1. (Remark in the margin in pencil.) A defence, against Hardy, of the decimal system in proofs, etc.

Page 455

†1. *Philosophical Remarks*, 122, pp. 143-145.

Page 464

†1. Cf. *The Foundations of Arithmetic*, §84. (Ed.)

Page 469

†1. *Grundgesetze d. Arithmetik*, II, § 83, pp. 93, 94.

Page 472

†1. See below, p. 484

THE BLUE AND THE BROWN BOOKS

Page i

Page Break ii

Page ii

Ludwig Wittgenstein from Blackwell Publishers

The Wittgenstein Reader
Edited by Anthony Kenny

Zettel
Second Edition
Edited by G.E.M. Anscombe and G.H. von Wright

Remarks on Colour
Edited by G.E.M. Anscombe

Remarks on the Foundations of Mathematics
Third Edition
Edited by G.H. von Wright, Rush Rhees and G.E.M. Anscombe

Philosophical Remarks
Edited by Rush Rhees

Philosophical Grammar
Edited by Rush Rhees

On Certainty
Edited by G.E.M. Anscombe and G.H. von Wright

Lectures and Conversations
Edited by Cyril Barrett

Culture and Value
Edited by G.H. von Wright

The Blue and Brown Books
Preliminary Studies for the *Philosophical Investigations*

Remarks on the Philosophy of Psychology, Vol. I
Edited by G.E.M. Anscombe and G.H. von Wright

Remarks on the Philosophy of Psychology, Vol. II
Edited by G.E.M. Anscombe and Heikki Nyman

Last Writings on the Philosophy of Psychology, Vol. I
Edited by G.H. von Wright and Heikki Nyman

Last Writings on the Philosophy of Psychology, Vol. II
Edited by G.H. von Wright and Heikki Nyman

Philosophical Investigations (German-English edition)
Translated by G.E.M. Anscombe

Page Break iii

Titlepage

Page iii

Generally known as
THE BLUE AND BROWN BOOKS

By
LUDWIG WITTGENSTEIN



BLACKWELL
Oxford UK & Cambridge USA

Page Break iv

Copyright page

Page iv

Copyright © Blackwell Publishers Ltd, 1958
Second Edition 1969
Reprinted 1972, 1975, 1978, 1980, 1984, 1987, 1989, 1992, 1993, 1994, 1997, 1998

Blackwell Publishers Ltd
108 Cowley Road
Oxford OX4 1JF, UK

ISBN 0-631-14660-1

Note on the Second Impression

There are a few alterations, taken from the text of the Blue Book in the possession of Mr. P. Sraffa. With the exception of changes on pp. 1 and 17 they make no difference to the sense, being mostly improvements in punctuation or grammar.

We rejected such changes as were no improvement.

The text of the Second Edition remains unaltered, but an index has been added.

All rights reserved. Except for the quotation of short passages for the purposes of criticism and review, no part of this publication may be reproduced, stored in a retrieval system, or transmitted, in any form or by any means, electronic, mechanical, photocopying, recording or otherwise, without the prior permission of the publisher.

Except in the United States of America, this book is sold subject to the condition that it shall not, by way of trade or otherwise, be lent, re-sold, hired out, or otherwise circulated without the publisher's prior consent in any form of binding or cover other than that in which it is published and without a similar condition including this condition being imposed on the subsequent purchaser.

Printed and bound in Great Britain by Athenæum Press Ltd, Gateshead, Tyne & Wear
This book is printed on acid-free paper

Page Break v

PREFACE

Page v

WITTGENSTEIN dictated the "Blue Book" (though he did not call it that) to his class in Cambridge during the session 1933-34, and he had stencilled copies made. He dictated the "Brown Book" to two of his pupils (Francis Skinner and Alice Ambrose) during 1934-35. He had only three typed copies made of this, and he showed them only to very close friends and pupils. But people who borrowed them made their own copies, and there was a trade in them. If Wittgenstein had named these dictations, he might have called them "Philosophical Remarks" or

"Philosophical Investigations". But the first lot was bound in blue wrappers and the second in brown, and they were always spoken of that way.

Page v

He sent a copy of the Blue Book to Lord Russell later on, with a covering note.

DEAR RUSSELL,

Two years ago, or so, I promised to send you a manuscript of mine. Now the one I am sending you to-day isn't *that* manuscript. I'm still pottering about with it, and God knows whether I will ever publish it, or any of it. But two years ago I held some lectures in Cambridge and dictated some notes to my pupils so that they might have something to carry home with them, in their hands if not in their brains. And I had these notes duplicated. I have just been correcting misprints and other mistakes in some of the copies and the idea came into my mind whether you might not like to have a copy. So I'm sending you one. I don't wish to suggest that you should read the lectures; but *if* you should have nothing better to do and *if* you should get some mild enjoyment out of them I should be very pleased indeed. (I think it's very difficult to understand them, as so many points are just hinted at. They are meant only for the people who heard the lectures.) As I say, if you don't read them *it doesn't matter at all*.

Yours ever,

LUDWIG WITTGENSTEIN.

Page v

That was all the Blue Book was, though: a set of notes. The Brown Book was rather different, and for a time he thought of it as a draft of something he might publish. He started more than once to make revisions of a German version of it. The last was in August, 1936. He brought this, with some minor changes and insertions, to the beginning of the discussion of voluntary action--about page 154 in

Page Break vi

our text. Then he wrote, in heavy strokes, "Dieser ganze 'Versuch einer Umarbeitung' vom (Anfang) bis hierher ist *nichts wert*". ("This whole attempt at a revision, from the start right up to this point, is *worthless*.") That was when he began what we now have (with minor revisions) as the first part of the *Philosophical Investigations*.

Page vi

I doubt if he would have published the Brown Book in English, whatever happened. And anyone who can read his German will see why. His English style is often clumsy and full of Germanisms. But we have left it that way, except in a very few cases where it marred the sense and the correction was obvious. What we are printing here are notes he gave to his pupils, and a draft for his own use; that is all.

Page vi

Philosophy was a method of investigation, for Wittgenstein, but his conception of the method was changing. We can see this in the way he uses the notion of "language games", for instance. He used to introduce them in order to shake off the idea of a necessary form of language. At least that was one use he made of them, and one of the earliest. It is often useful to imagine different language games. At first he would sometimes write "different forms of language"--as though that were the same thing; though he corrected it in later versions, sometimes. In the Blue Book he speaks sometimes of imagining different language games, and sometimes of imagining different *notations*--as though that were what it amounted to. And it looks as though he had not distinguished clearly between being able to speak and understanding a notation.

Page vi

He speaks of coming to understand what people mean by having someone explain the meanings of the words, for instance. As though "understanding" and "explaining" were somehow correlative. But in the Brown Book he emphasizes that learning a language game is something prior to that. And what is needed is not explanation but *training*--comparable with the training you would give an animal. This goes with the point he emphasizes in the *Investigations*, that being able to speak and understand what is said--knowing what it means--does not mean that you can *say* what it means; nor is that what you have learned. He says there too (*Investigations*, par. 32) that "Augustine describes the learning of human language as if the child came into a strange country and did not understand the language of the country; that is, as if it already had a language, only not this one". You might see whether the child knows French by asking him what the expressions mean. But that is not how you tell whether a child can speak. And it is not what he learns when he learns to speak.

Page Break vii

Page vii

When the Brown Book speaks of different language games as "systems of communication" (Systeme menschlicher Verständigung), these are not just different notations. And this introduces a notion of understanding, and of the relation of understanding and language, which does not come to the front in the Blue Book at all. In the Brown Book he is insisting, for example, that "understanding" is not one thing; it is as various as the language games

themselves are. Which would be one reason for saying that when we do imagine different language games, we are not imagining parts or possible parts of any general system of language.

Page vii

The Blue Book is less clear about that. On page 17 he says that "the study of language games is the study of primitive forms of language or primitive languages". But then he goes on, "If we want to study the problems of truth and falsehood, of the agreement and disagreement of propositions with reality, of the nature of assertion, assumption and question, we shall with great advantage look at primitive forms of language in which these forms of thinking appear without the confusing background of highly complicated processes of thought. When we look at such simple forms of language, the mental mist which seems to enshroud our ordinary use of language disappears. We see activities, reactions, which are clear-cut and transparent. On the other hand we recognize in these simple processes forms of language not separated by a break from our more complicated ones. We see that we can build up the complicated forms from the primitive ones by gradually adding new forms."

Page vii

That almost makes it look as though we were trying to give something like an analysis of our ordinary language. As though we wanted to discover something that goes on in our language as we speak it, but which we cannot see until we take this method of getting through the mist that enshrouds it. And as if "the nature of assertion, assumption and question" were the same there; we have just found a way of making it transparent. Whereas the Brown Book is denying that. That is why he insists in the Brown Book (p. 81) that he is "not regarding the language games which we describe as incomplete parts of a language, but as languages complete in themselves". So that, for instance, certain grammatical functions in one language would not have any counterpart in another at all. And "agreement or disagreement with reality" would be something different in the different languages--so that the study of it in that language might not show you much about what it is in this one. That is why he asks in the

Page Break viii

Brown Book whether "Brick" means the same in the primitive language as it does in ours; this goes with his contention that the simpler language is not an incomplete form of the more complicated one. That discussion of whether we have to do here with an elliptical sentence is an important part of his account of what different language games are. But there is not even an anticipation of it in the Blue Book.

Page viii

In one of Wittgenstein's note-books there is a remark about language games, which he must have written at the beginning of 1934. I suspect it is later than the one I have quoted from page 17; anyway, it is different. "Wenn ich bestimmte einfache Sprachspiele beschreibe, so geschieht es nicht, um mit ihnen nach und nach die Vorgänge der ausgebildeten Sprache--oder des Denkens--aufzubauen, was nur zu Ungerechtigkeiten führt (Nicod und Russell),--sondern ich stelle die Spiele als solche hin, und lasse sie ihre aufklärende Wirkung auf die besonderen Probleme ausstrahlen." ("When I describe certain simple language games, this is not in order to construct from them gradually the processes of our developed language--or of thinking--which only leads to injustices (Nicod and Russell). I simply set forth the games as what they are, and let them shed their light on the particular problems.")

Page viii

I think that would be a good description of the method in the first part of the Brown Book. But it also points to the big difference between the Brown Book and the *Investigations*.

Page viii

In the Brown Book the account of the different language games is not directly a discussion of particular philosophical problems, although it is intended to throw light on them. It throws light on various aspects of language, especially--aspects to which we are often blinded just by the tendencies that find their sharpest expression in the problems of philosophy. And in this way the discussion does suggest where it is that the difficulties arise which give birth to those problems.

Page viii

For instance, in what he says about "can", and the connection between this and "seeing what is common", he is raising the question of what it is that you learn when you learn the language; or of what you know when you know what something means. But he is also raising the question of what it would mean to ask how the language *can* be developed--"Is that still something that has sense? Are you still speaking now, or is it gibberish?" And this may lead on to the question of "What can be said", or again of "How we should know it was a proposition"; or what a proposition is, or what language is. The way in which he describes the language games here is intended

Page Break ix

to show that one *need* not be led into asking those questions, and that it would be a misunderstanding if one were. But the trouble is that we are left wondering why people constantly *are*. And in this the *Investigations* is different.

The language games there (in the *Investigations*) are not stages in the exposition of a more complicated language, any more than they are in the Brown Book; less so, if anything. But they are stages in a discussion leading up to the "big question" of what language is (in par. 65).

He brings them in--in the *Investigations* and in the Brown Book too--to throw light on the question about the relation of words and what they stand for. But in the *Investigations* he is concerned with "the philosophical conception of meaning" which we find in Augustine, and he shows that this is the expression of a tendency which comes out most plainly in that theory of logically proper names which holds that the only *real* names are the demonstratives *this* and *that*. He calls this "a tendency to sublime the logic of our language" (die Logik unserer Sprache zu sublimieren) (par. 38)--partly because, in comparison with the logically proper names, "anything else we might call a name was one only in an inexact, approximate sense". It is this tendency which leads people to talk about the ultimate nature of language, or the logically correct grammar. But why should people fall into it? There is no simple answer, but Wittgenstein begins an answer here by going on to discuss the notions of "simple" and "complex" and the idea of logical analysis. (He does not do this in the Brown Book at all; and if all he wanted were to throw light on the functioning of language, there would be no need to.)

The whole idea of a logical analysis of language, or the logical analysis of propositions, is a queer and confused one. And in setting forth his language games Wittgenstein was not trying to give any analysis at all. If we call them "more primitive" or "simpler" languages, that does not mean that they reveal anything like the elements which a more complicated language must have. (Cf. *Investigations*, par. 64.) They are different languages--not elements or aspects of "Language". But then we may want to ask what there is about them that makes us say that they *are* all languages. What makes anything a language, anyway? And that is the "big question" (par. 65) about the nature of language or the nature of the proposition, which has lain behind the whole discussion up to this point.

We might even say that the discussion up to this point in the *Investigations* has been an attempt to bring out the sense of treating philosophical

problems by reference to language games at all. Or perhaps better: to show how the use of language games can make clear what a philosophical problem is.

In the Brown Book, on the other hand, he passes from examples of different sorts of naming to a discussion of various ways of "comparing with reality". This is still a discussion of the relations of words and what they stand for, no doubt. But he is not trying here to bring out the tendency behind that way of looking at words which has given trouble in philosophy.

In the *Investigations* he goes on then to a discussion of the relations of logic and language, but he does not do that in the Brown Book--although it is closely connected with what he says there. I mean especially what he says there about "can", and the connection of that with the idea of what can be said. ("When do we say that this is still language? When do we say it is a proposition?") For the temptation then is to think of a calculus, and of what can be said in it. But Wittgenstein would call that a misunderstanding of what a rule of language is, and of what using language is. When we speak as we generally do, we are not using precisely definable concepts, nor precise rules either. And the intelligibility is something different from intelligibility in a calculus.

It was because people thought of "what can be said" as "what is allowed in a calculus" ("For what other sense of 'allowed' is there?")--it was for that reason that logic was supposed to govern the *unity* of language: what belongs to language and what does not; what is intelligible and what is not; what is a proposition and what is not. In the Brown Book Wittgenstein is insisting that language does not have *that* kind of unity. Nor that kind of intelligibility. But he does not really discuss why people have wanted to suppose that it has.

You might think he had done that earlier, in the Blue Book, but I do not think he did. I do not think he sees the question about logic and language there which the Brown Book is certainly bringing out, even if it does not make quite clear what kind of difficulty it is. On page 25 of the Blue Book he says that "in general we don't use language according to strict rules--it hasn't been taught us by means of strict rules, either. *We*, in our discussions on the other hand, constantly compare language with a calculus proceeding according to exact rules." When he asks (at the bottom of the page) *why* we do this, he replies simply, "The answer is that the puzzles which we try to remove

always spring from just this attitude towards language". And

Page Break xi

you might wonder whether that *is* an answer. His point, as he puts it on page 27, for instance, is that "the man who is philosophically puzzled sees a law in the way a word is used, and, trying to apply this law consistently, comes up against... paradoxical results". And at first that looks something like what he said later, in the *Investigations*, about a tendency to sublime the logic of our language. But here in the Blue Book he does not bring out what there is about the use of language or the understanding of language that *leads* people to think of words in that way. Suppose we say that it is because philosophers look on language metaphysically. All right; but when we ask what makes them do *that*, Wittgenstein answers in the Blue Book that it is because of a craving for generality, and because "philosophers constantly see the method of science before their eyes, and are irresistibly tempted to ask and answer questions in the way science does" (p. 18). In other words, he does not find the source of metaphysics in anything specially connected with language. That is one very important point here, and it means that he was not anything like as clear about the character of philosophical puzzlement as he was when he wrote the *Investigations*. But in any case, it is not that tendency--to ask and answer questions in the way science does--or it is not primarily that, which leads philosophers to think of an ideal language or of a logically correct grammar when they are puzzled about language or about understanding. That comes in a different way.

Page xi

Wittgenstein is quite clear in the Blue Book that we do not use language according to strict rules, and that we do not use words according to laws like the laws that science speaks of. But he is not quite clear about the notions of "knowing the meaning" or of "understanding"; and that means that he is still unclear about a great deal in the notion of "following a rule" too. And for that reason he does not altogether recognize the kind of confusions that there may be when people say that knowing the language is knowing what *can* be said.

Page xi

"What does the *possibility* of the meanings of our words depend on?" That is what is behind the idea of meaning that we find in the theory of logically proper names and of logical analysis. And it goes with a question of what you learn when you learn the language; or of what learning the language is. Wittgenstein makes it plain in the Blue Book that words have the meanings we give them, and that it would be a confusion to think of an investigation into their *real* meanings. But he has not yet seen clearly the difference between learning a

Page Break xii

language game and learning a notation. And for that reason he cannot quite make out the character of the confusion he is opposing.

Page xii

In other words, in the Blue Book Wittgenstein had not seen clearly what the question about the requirements of language or the intelligibility of language is. That is why he can say, on page 28, that "ordinary language is all right". Which is like saying "it is a language, all right". And that seems to mean that it satisfies the requirements. But when he speaks like that, he is himself in the sort of confusion that he later brought out. And it seems to me to obscure the point of ideal languages--to obscure what those who spoke of them were trying to do--if one speaks, as Wittgenstein does here, as though "making up ideal languages" were what he was doing when he made up language games. He would not have spoken that way later.

Page xii

It may be this same unclarity, or something akin to it, that leads Wittgenstein to speak more than once in the Blue Book of "the calculus of language" (e.g. p. 42, top paragraph; or, better, p. 65, middle paragraph and last line)--although he has also said that it is only in very rare cases that we use language as a calculus. If you have not distinguished between a language and a notation, you may hardly see any difference between following a language and following a notation. But in that case you may well be unclear about the difficulties in connection with the relation between language and logic.

Page xii

Those difficulties become much clearer in the Brown Book, even though he does not explicitly refer to them there. We might say that they are the principal theme of the *Investigations*.

Page xii

For that is the theme that underlies the discussions of "seeing something as something" as well as the earlier parts. And once again we find that Wittgenstein in the *Investigations* is making these discussions into an exposition of the philosophical difficulties, in a way that he has not done in the Brown Book.

Page xii

At one time Wittgenstein was interested in the question of what it is to "recognize it as a proposition" (even

though it may be entirely unfamiliar), or to recognize something as language--to recognize that that is something written there, for instance--independently of your recognition of what it says. The second part of the Brown Book bears on this. And it shows that when such "recognitions" are rightly seen, they should not lead to the kinds of questions that philosophers have asked. The analogies that he draws between understanding a sentence and understanding a musical theme, for instance; or between wanting to say that this sentence means something and wanting to

Page Break xiii

say that this colour pattern says something--show clearly that it is not as though you were recognizing any *general* character (of intelligibility, perhaps) and that you ought to be able to tell us what that is, any more than it would make sense for you to ask me what the colour pattern does say.

Page xiii

But why *have* people wanted to speak of "meta-logic" in this connection, for instance? The Brown Book does something to explain that, and hints at more. But there is something about the way in which we use language, and in the connection of language and thinking--the force of an argument, and the force of expressions generally--which makes it seem as though recognizing it as a language were very different even from recognizing it as a move in a game. (As though understanding were something outside the signs; and as though to be a language it needs something that does not appear in the system of signs themselves.) And in the last sections of the *Investigations* he is trying to take account of this.

Page xiii

He had spoken of "operating with signs". And someone might say, "You make it look just like operating a mechanism; like any other mechanism. And if that is all there is to it--just the mechanism--then it is not a language." Well, there is no short answer to that. But it is an important question. So is the question of what we mean by "thinking *with* signs", for instance. What is that? And is the reference to making pencil strokes on paper really helpful?

Page xiii

Much of all this can be answered by emphasizing that speaking and writing belong to intercourse with other people. The signs get their life there, and that is why the language is not just a mechanism.

Page xiii

But the objection is that someone might do all that, make the signs correctly in the "game" with other people and get along all right, even if he were "meaning-blind". Wittgenstein used that expression in analogy with "colour-blind" and "tone-deaf". If I say an ambiguous word to you, like "board", for instance, I may ask you what meaning you think of when you hear it, and you may say that you think of a committee like the Coal Board, or perhaps you do not but think of a plank. Well, could we not imagine someone who could make no sense of such a question? If you just said a word to him like that, it gave him no meaning. And yet he could "react with words" to the sentences and other utterances he encountered, and to situations too, and react correctly. Or can we *not* imagine that? Wittgenstein was not sure, I think. If a man were "meaning-blind", would that make

Page Break xiv

any difference to his use of language? Or does the perception of meaning fall outside the use of language?

Page xiv

There is something wrong about that last question; something wrong about *asking* it. But it seems to show that there is still something unclear in our notion of "the use of language".

Page xiv

Or again, if we simply emphasize that signs belong to intercourse with people, what are we going to say about the role of "insight" in connection with mathematics and the discovery of proofs, for instance?

Page xiv

So long as there are such difficulties, people will still think that there must be something like an interpretation. They will still think that if it is language then it must mean something to *me*. And so on. And for this reason--in order to try to understand the kinds of difficulties these are--it was necessary for Wittgenstein to go into the whole complicated matter of "seeing something as something" in the way he was doing.

Page xiv

And the method has to be somewhat different there. One cannot do so much with language games.

R. R.

March, 1958

Page Break xv

THE BLUE BOOK

Page xv

Page Break xvi

Page Break 1

Page 1

THE BLUE BOOK

Page 1

WHAT is the meaning of a word?

Page 1

Let us attack this question by asking, first, what is an explanation of the meaning of a word; what does the explanation of a word look like?

Page 1

The way this question helps us is analogous to the way the question "how do we measure a length?" helps us to understand the problem "what is length?"

Page 1

The questions "What is length?", "What is meaning?", "What is the number one?" etc., produce in us a mental cramp. We feel that we can't point to anything in reply to them and yet ought to point to something. (We are up against one of the great sources of philosophical bewilderment: a substantive makes us look for a thing that corresponds to it.)

Page 1

Asking first "What's an explanation of meaning?" has two advantages. You in a sense bring the question "what is meaning?" down to earth. For, surely, to understand the meaning of "meaning" you ought also to understand the meaning of "explanation of meaning". Roughly: "let's ask what the explanation of meaning is, for whatever that explains will be the meaning." Studying the grammar of the expression "explanation of meaning" will teach you something about the grammar of the word "meaning" and will cure you of the temptation to look about you for some object which you might call "the meaning".

Page 1

What one generally calls "explanations of the meaning of a word" can, *very roughly*, be divided into verbal and ostensive definitions. It will be seen later in what sense this division is only rough and provisional (and that it is, is an important point). The verbal definition, as it takes us from one verbal expression to another, in a sense gets us no further. In the ostensive definition however we seem to make a much more real step towards learning the meaning.

Page 1

One difficulty which strikes us is that for many words in our language there do not seem to be ostensive definitions; e.g. for such words as "one", "number", "not", etc.

Page 1

Question: Need the ostensive definition itself be understood?--Can't the ostensive definition be misunderstood?

Page Break 2

Page 2

If the definition explains the meaning of a word, surely it can't be essential that you should have heard the word before. It is the ostensive definition's business to *give* it a meaning. Let us then explain the word "tove" by pointing to a pencil and saying "this is tove". (Instead of "this is tove" I could here have said "this is called 'tove' ". I point this out to remove, once and for all, the idea that the words of the ostensive definition predicate something of the defined; the confusion between the sentence "this is red", attributing the colour red to something, and the ostensive definition "this is called 'red'".) Now the ostensive definition "this is tove" can be interpreted in all sorts of ways. I will give a few such interpretations and use English words with well established usage. The definition then can be interpreted to mean:

"This is a pencil",
"This is round",
"This is wood",
"This is one",
"This is hard", etc. etc.

Page 2

One might object to this argument that all these interpretations presuppose another word-language. And this

objection is significant if by "interpretation" we only mean "translation into a word-language".--Let me give some hints which might make this clearer. Let us ask ourselves what is our criterion when we say that someone has interpreted the ostensive definition in a particular way. Suppose I give to an Englishman the ostensive definition "this is what the Germans call 'Buch'". Then, in the great majority of cases at any rate, the English word "book" will come into the Englishman's mind. We may say he has interpreted "Buch" to mean "book". The case will be different if e.g. we point to a thing which he has never seen before and say: "This is a banjo". Possibly the word "guitar" will then come into his mind, possibly no word at all but the image of a similar instrument, possibly nothing at all. Supposing then I give him the order "now pick a banjo from amongst these things." If he picks what we call a "banjo" we might say "he has given the word 'banjo' the correct interpretation"; if he picks some other instrument--"he has interpreted 'banjo' to mean 'string instrument'".

Page 2

We say "he has given the word 'banjo' this or that interpretation", and are inclined to assume a definite act of interpretation besides the act of choosing.

Page Break 3

Page 3

Our problem is analogous to the following:

Page 3

If I give someone the order "fetch me a red flower from that meadow", how is he to know what sort of flower to bring, as I have only given him a *word*?

Page 3

Now the answer one might suggest first is that he went to look for a red flower carrying a red image in his mind, and comparing it with the flowers to see which of them had the colour of the image. Now there is such a way of searching, and it is not at all essential that the image we use should be a mental one. In fact the process may be this: I carry a chart co-ordinating names and coloured squares. When I hear the order "fetch me etc." I draw my finger across the chart from the word "red" to a certain square, and I go and look for a flower which has the same colour as the square. But this is not the only way of searching and it isn't the usual way. We go, look about us, walk up to a flower and pick it, without comparing it to anything. To see that the process of obeying the order can be of this kind, consider the order "*imagine* a red patch". You are not tempted in this case to think that *before* obeying you must have imagined a red patch to serve you as a pattern for the red patch which you were ordered to imagine.

Page 3

Now you might ask: do we *interpret* the words before we obey the order? And in some cases you will find that you do something which might be called interpreting before obeying, in some cases not.

Page 3

It seems that there are *certain definite* mental processes bound up with the working of language, processes through which alone language can function. I mean the processes of understanding and meaning. The signs of our language seem dead without these mental processes; and it might seem that the only function of the signs is to induce such processes, and that these are the things we ought really to be interested in. Thus, if you are asked what is the relation between a name and the thing it names, you will be inclined to answer that the relation is a psychological one, and perhaps when you say this you think in particular of the mechanism of association.--We are tempted to think that the action of language consists of two parts; an inorganic part, the handling of signs, and an organic part, which we may call understanding these signs, meaning them, interpreting them, thinking. These latter activities seem to take place in a queer kind of medium, the mind; and the mechanism of the mind, the nature of which, it seems, we don't quite understand, can bring about effects which no material mechanism could. Thus e.g. a thought (which is such a mental

Page Break 4

process) can agree or disagree with reality; I am able to think of a man who isn't present; I am able to imagine him, 'mean him' in a remark which I make about him, even if he is thousands of miles away or dead. "What a queer mechanism," one might say, "the mechanism of wishing must be if I can wish that which will never happen".

Page 4

There is one way of avoiding at least partly the occult appearance of the processes of thinking, and it is, to replace in these processes any working of the imagination by acts of looking at real objects. Thus it may seem essential that, at least in certain cases, when I hear the word "red" with understanding, a red image should be before my mind's eye. But why should I not substitute seeing a red bit of paper for imagining a red patch? The visual image will only be the more vivid. Imagine a man always carrying a sheet of paper in his pocket on which the names of colours are co-ordinated with coloured patches. You may say that it would be a nuisance to carry such a table of

samples about with you, and that the mechanism of association is what we always use instead of it. But this is irrelevant; and in many cases it is not even true. If, for instance, you were ordered to paint a particular shade of blue called "Prussian Blue", you might have to use a table to lead you from the word "Prussian Blue" to a sample of the colour, which would serve you as your copy.

Page 4

We could perfectly well, for our purposes, replace every process of imagining by a process of looking at an object or by painting, drawing or modelling; and every process of speaking to oneself by speaking aloud or by writing.

Page 4

Frege ridiculed the formalist conception of mathematics by saying that the formalists confused the unimportant thing, the sign, with the important, the meaning. Surely, one wishes to say, mathematics does not treat of dashes on a bit of paper. Frege's idea could be expressed thus: the propositions of mathematics, if they were just complexes of dashes, would be dead and utterly uninteresting, whereas they obviously have a kind of life. And the same, of course, could be said of any proposition: Without a sense, or without the thought, a proposition would be an utterly dead and trivial thing. And further it seems clear that no adding of inorganic signs can make the proposition live. And the conclusion which one draws from this is that what must be added to the dead signs in order to make a live proposition is something immaterial, with properties different from all mere signs.

Page 4

But if we had to name anything which is the life of the sign, we should have to say that it was its *use*.

Page Break 5

Page 5

If the meaning of the sign (roughly, that which is of importance about the sign) is an image built up in our minds when we see or hear the sign, then first let us adopt the method we just described of replacing this mental image by some outward object seen, e.g. a painted or modelled image. Then why should the written sign plus this painted image be alive if the written sign alone was dead?—In fact, as soon as you think of replacing the mental image by, say, a painted one, and as soon as the image thereby loses its occult character, it ceases to seem to impart any life to the sentence at all. (It was in fact just the occult character of the mental process which you needed for your purposes.)

Page 5

The mistake we are liable to make could be expressed thus: We are looking for the use of a sign, but we look for it as though it were an object *co-existing* with the sign. (One of the reasons for this mistake is again that we are looking for a "thing corresponding to a substantive.")

Page 5

The sign (the sentence) gets its significance from the system of signs, from the language to which it belongs. Roughly: understanding a sentence means understanding a language.

Page 5

As a part of the system of language, one may say, the sentence has life. But one is tempted to imagine that which gives the sentence life as something in an occult sphere, accompanying the sentence. But whatever accompanied it would for us just be another sign.

Page 5

It seems at first sight that that which gives to thinking its peculiar character is that it is a train of mental states, and it seems that what is queer and difficult to understand about thinking is the processes which happen in the medium of the mind, processes possible only in this medium. The comparison which forces itself upon us is that of the mental medium with the protoplasm of a cell, say, of an amoeba. We observe certain actions of the amoeba, its taking food by extending arms, its splitting up into similar cells, each of which grows and behaves like the original one. We say "of what a queer nature the protoplasm must be to act in such a way", and perhaps we say that no physical mechanism could behave in this way, and that the mechanism of the amoeba must be of a totally different kind. In the same way we are tempted to say "the mechanism of the mind must be of a most peculiar kind to be able to do what the mind does". But here we are making two mistakes. For what struck *us* as being queer about thought and thinking was not at all that it had curious effects which

Page Break 6

we were not yet able to explain (causally). Our problem, in other words, was not a scientific one; but a muddle felt as a problem.

Page 6

Supposing we tried to construct a mind-model as a result of psychological investigations, a model which, as

we should say, would explain the action of the mind. This model would be part of a psychological theory in the way in which a mechanical model of the ether can be part of a theory of electricity. (Such a model, by the way, is always part of the *symbolism* of a theory. Its advantage may be that it can be taken in at a glance and easily held in the mind. It has been said that a model, in a sense, dresses up the pure theory; that the *naked* theory is sentences or equations. This must be examined more closely later on.)

Page 6

We may find that such a mind-model would have to be very complicated and intricate in order to explain the observed mental activities; and on this ground we might call the mind a queer kind of medium. But this aspect of the mind does not interest us. The problems which it may set are psychological problems, and the method of their solution is that of natural science.

Page 6

Now if it is not the causal connections which we are concerned with, then the activities of the mind lie open before us. And when we are worried about the nature of thinking, the puzzlement which we wrongly interpret to be one about the nature of a medium is a puzzlement caused by the mystifying use of our language. This kind of mistake recurs again and again in philosophy; e.g. when we are puzzled about the nature of time, when time seems to us a *queer thing*. We are most strongly tempted to think that here are things hidden, something we can see from the outside but which we can't look into. And yet nothing of the sort is the case. It is not new facts about time which we want to know. All the facts that concern us lie open before us. But it is the use of the substantive "time" which mystifies us. If we look into the grammar of that word, we shall feel that it is no less astounding that man should have conceived of a deity of time than it would be to conceive of a deity of negation or disjunction.

Page 6

It is misleading then to talk of thinking as of a "mental activity". We may say that thinking is essentially the activity of operating with signs. This activity is performed by the hand, when we think by writing; by the mouth and larynx, when we think by speaking; and if we think by imagining signs or pictures, I can give you no agent that thinks. If then you say that in such cases the mind thinks, I would only draw your attention to the fact that you are using a metaphor, that here

Page Break 7

the mind is an agent in a different sense from that in which the hand can be said to be the agent in writing.

Page 7

If again we talk about the locality where thinking takes place we have a right to say that this locality is the paper on which we write or the mouth which speaks. And if we talk of the head or the brain as the locality of thought, this is using the expression "locality of thinking" in a different sense. Let us examine what are the reasons for calling the head the place of thinking. It is not our intention to criticize this form of expression, or to show that it is not appropriate. What we must do is: understand its working, its grammar, e.g. see what relation this grammar has to that of the expression "we think with our mouth", or "we think with a pencil on a piece of paper".

Page 7

Perhaps the main reason why we are so strongly inclined to talk of the head as the locality of our thoughts is this: the existence of the words "thinking" and "thought" alongside of the words denoting (bodily) activities, such as writing, speaking, etc., makes us look for an activity, different from these but analogous to them, corresponding to the word "thinking". When words in our ordinary language have *prima facie* analogous grammars we are inclined to try to interpret them analogously; i.e. we try to make the analogy hold throughout.--We say, "The thought is not the same as the sentence; for an English and a French sentence, which are utterly different, can express the same thought". And now, as the sentences are *somewhere*, we look for a place for the thought. (It is as though we looked for the place of the king of which the rules of chess treat, as opposed to the places of the various bits of wood, the kings of the various sets.)--We say, "surely the thought is *something*; it is not nothing"; and all one can answer to this is, that the word "thought" has its *use*, which is of a totally different kind from the use of the word "sentence".

Page 7

Now does this mean that it is nonsensical to talk of a locality where thought takes place? Certainly not. This phrase has sense' if we give it sense. Now if we say "thought takes place in our heads", what is the sense of this phrase soberly understood? I suppose it is that certain physiological processes correspond to our thoughts in such a way that if we know the correspondence we can, by observing these processes, find the thoughts. But in what sense can the physiological processes be said to correspond to thoughts, and in what sense can we be said to get the thoughts from the observation of the brain?

Page 7

I suppose we imagine the correspondence to have been verified experimentally. Let us imagine such an experiment crudely. It

consists in looking at the brain while the subject thinks. And now you may think that the reason why my explanation is going to go wrong is that of course the experimenter gets the thoughts of the subject only *indirectly* by being told them, the subject *expressing* them in some way or other. But I will remove this difficulty by assuming that the subject is at the same time the experimenter, who is looking at his own brain, say by means of a mirror. (The crudity of this description in no way reduces the force of the argument.)

Then I ask you, is the subject-experimenter observing one thing or two things? (Don't say that he is observing one thing both from the inside and from the outside; for this does not remove the difficulty. We will talk of inside and outside later.†1) The subject-experimenter is observing a correlation of two phenomena. One of them he, perhaps, calls the *thought*. This may consist of a train of images, organic sensations, or on the other hand of a train of the various visual, tactual and muscular experiences which he has in writing or speaking a sentence.--The other experience is one of seeing his brain work. Both these phenomena could correctly be called "expressions of thought"; and the question "where is the thought itself?" had better, in order to prevent confusion, be rejected as nonsensical. If however we do use the expression "the thought takes place in the head", we have given this expression its meaning by describing the experience which would justify the *hypothesis* that the thought takes place in our heads, by describing the experience which we wish to call "observing thought in our brain".

We easily forget that the word "locality" is used in many different senses and that there are many different kinds of statements about a thing which in a particular case, in accordance with general usage, we may call specifications of the locality of the thing. Thus it has been said of visual space that its place is in our head; and I think one has been tempted to say this, partly, by a grammatical misunderstanding.

I can say: "in my visual field I see the image of the tree to the right of the image of the tower" or "I see the image of the tree in the middle of the visual field". And now we are inclined to ask "and where do you see the visual field?" Now if the "where" is meant to ask for a locality in the sense in which we have specified the locality of the image of the tree, then I would draw your attention to the fact that you have not yet given this question sense; that is, that you have been

proceeding by a grammatical analogy without having worked out the analogy in detail.

In saying that the idea of our visual field being located in our brain arose from a grammatical misunderstanding, I did not mean to say that we could not give sense to such a specification of locality. We could, e.g., easily imagine an experience which we should describe by such a statement. Imagine that we looked at a group of things in this room, and, while we looked, a probe was stuck into our brain and it was found that if the point of the probe reached a particular point in our brain, then a particular small part of our visual field was thereby obliterated. In this way we might co-ordinate points of our brain to points of the visual image, and this might make us say that the visual field was seated in such and such a place in our brain. And if now we asked the question "Where do you see the image of this book?" the answer could be (as above) "To the right of that pencil", or "In the left hand part of my visual field", or again: "Three inches behind my left eye".

But what if someone said "I can assure you I feel the visual image to be two inches behind the bridge of my nose"; what are we to answer him? Should we say that he is not speaking the truth, or that there cannot be such a feeling? What if he asks us "do you know all the feelings there are? How do you know there isn't such a feeling?"

What if the diviner tells us that when he holds the rod he *feels* that the water is five feet under the ground? or that he *feels* that a mixture of copper and gold is five feet under the ground? Suppose that to our doubts he answered: "You can estimate a length when you see it. Why shouldn't I have a different way of estimating it?"

If we understand the idea of such an estimation, we shall get clear about the nature of our doubts about the statements of the diviner, and of the man who said he felt the visual image behind the bridge of his nose.

There is the statement: "this pencil is five inches long", and the statement, "I feel that this pencil is five inches long", and we must get clear about the relation of the grammar of the first statement to the grammar of the second.

To the statement "I feel in my hand that the water is three feet under the ground" we should like to answer: "I don't know what this *means*". But the diviner would say: "Surely you know what it means. You know what 'three feet under the ground' means, and you know what 'I feel' means!" But I should answer him: I know what a word means *in certain contexts*. Thus I

Page Break 10

understand the phrase, "three feet under the ground", say, in the connections "The measurement has shown that the water runs three feet under the ground", "If we dig three feet deep we are going to strike water", "The depth of the water is three feet by the eye". But the use of the expression "a feeling in my hands of water being three feet under the ground" has yet to be explained to me.

Page 10

We could ask the diviner "how did you learn the meaning of the word 'three feet'? We suppose by being shown such lengths, by having measured them and such like. Were you also taught to talk of a feeling of water being three feet under the ground, a feeling, say, in your hands? For if not, what made you connect the word 'three feet' with a feeling in your hand?" Supposing we had been estimating lengths by the eye, but had never spanned a length. How could we estimate a length in inches by spanning it? I.e., how could we interpret the experience of spanning in inches? The question is: what connection is there between, say, a tactual sensation and the experience of measuring a thing by means of a yard rod? This connection will show us what it means to 'feel that a thing is six inches long'. Supposing the diviner said "I have never learnt to correlate depth of water under the ground with feelings in my hand, but when I have a certain feeling of tension in my hands, the words 'three feet' spring up in my mind." We should answer "This is a perfectly good explanation of what you mean by 'feeling the depth to be three feet', and the statement that you feel this will have neither more, nor less, meaning than your explanation has given it. And if experience shows that the actual depth of the water always agrees with the words '*n* feet' which come into your mind, your experience will be very useful for determining the depth of water".--But you see that the meaning of the words "I feel the depth of the water to be *n* feet" had to be explained; it was not known when the meaning of the words "*n* feet" in the ordinary sense (i.e. in the ordinary contexts) was known.--We don't say that the man who tells us he feels the visual image two inches behind the bridge of his nose is telling a lie or talking nonsense. But we say that we don't understand the meaning of such a phrase. It combines well-known words, but combines them in a way we don't yet understand. The grammar of this phrase has yet to be explained to us.

Page 10

The importance of investigating the diviner's answer lies in the fact that we often think we have given a meaning to a statement P if only we assert "I *feel* (or I believe) that P is the case." (We shall talk at a later

Page Break 11

occasion†1 of Prof. Hardy saying that Goldbach's theorem is a proposition because he can believe that it is true.) We have already said that by merely explaining the meaning of the words "three feet" in the usual way we have not yet explained the sense of the phrase "feeling that water is three feet etc." Now we should not have felt these difficulties had the diviner said that he had *learnt* to estimate the depth of the water, say, by digging for water whenever he had a particular feeling and in this way correlating such feelings with *measurements* of depth. Now we must examine the relation of the process of *learning to estimate* with the act of estimating. The importance of this examination lies in this, that it applies to the relation between learning the meaning of a word and making use of the word. Or, more generally, that it shows the different possible relations between a rule given and its application.

Page 11

Let us consider the process of estimating a length by the eye: It is extremely important that you should realise that there are a great many different processes which we call "estimating by the eye".

Page 11

Consider these cases:--

Page 11

- (1) Someone asks "How did you estimate the height of this building?" I answer: "It has four storeys; I suppose each storey is about fifteen feet high; so it must be about sixty feet."
- (2) In another case: "I roughly know what a yard at that distance looks like; so it must be about four yards long."
- (3) Or again: "I can imagine a tall man reaching to about this point; so it must be about six feet above the ground."
- (4) Or: "I don't know; it just looks like a yard."

Page 11

This last case is likely to puzzle us. If you ask "what happened in this case when the man estimated the length?" the correct answer may be: "he *looked* at the thing and *said* 'it looks one yard long'." This may be all that has happened.

Page 11

We said before that we should not have been puzzled about the diviner's answer if he had told us that he had *learnt* how to estimate depth. Now learning to estimate may, broadly speaking, be seen in two different relations to the act of estimating; either as a cause of the phenomenon of estimating, or as supplying us with a rule (a table, a chart, or some such thing) which we make use of when we estimate.

Page 11

Supposing I teach someone the use of the word "yellow" by repeatedly pointing to a yellow patch and pronouncing the word.

Page Break 12

On another occasion I make him apply what he has learnt by giving him the order, "choose a yellow ball out of this bag". What was it that happened when he obeyed my order? I say "possibly just this: he heard my words and took a yellow ball from the bag". Now you may be inclined to think that this couldn't possibly have been all; and the *kind* of thing that you would suggest is that he imagined something yellow when he *understood* the order, and then chose a ball according to his image. To see that this is not *necessary* remember that I could have given him the order, "Imagine a yellow patch". Would you still be inclined to assume that he first imagines a yellow patch, just *understanding* my order, and then imagines a yellow patch to match the first? (Now I don't say that this is not possible. Only, putting it in this way immediately shows you that it need not happen. This, by the way, illustrates the method of philosophy.)

Page 12

If we are taught the meaning of the word "yellow" by being given some sort of ostensive definition (a rule of the usage of the word) this teaching can be looked at in two different ways.

Page 12

A. The teaching is a drill. This drill causes us to associate a yellow image, yellow things, with the word "yellow". Thus when I gave the order "Choose a yellow ball from this bag" the word "yellow" might have brought up a yellow image, or a feeling of recognition when the person's eye fell on the yellow ball. The drill of teaching could in this case be said to have built up a psychical mechanism. This, however, would only be a hypothesis or else a metaphor. We could *compare* teaching with installing an electric connection between a switch and a bulb. The parallel to the connection going wrong or breaking down would then be what we call forgetting the explanation, or the meaning, of the word. (We ought to talk further on about the meaning of "forgetting the meaning of a word"†1).

Page 12

In so far as the teaching brings about the association, feeling of recognition, etc. etc., it is the *cause* of the phenomena of understanding, obeying, etc.; and it is a hypothesis that the process of teaching should be needed in order to bring about these effects. It is conceivable, in this sense, that *all* the processes of understanding, obeying, etc., should have happened without the person ever having been taught the language. (This, just now, seems extremely paradoxical.)

Page 12

B. The teaching may have supplied us with a rule which is itself involved in the processes of understanding, obeying, etc.; "involved",

Page Break 13

however, meaning that the expression of this rule forms part of these processes.

Page 13

We must distinguish between what one might call "a process being *in accordance with* a rule", and, "a process involving a rule" (in the above sense).

Page 13

Take an example. Some one teaches me to square cardinal numbers; he writes down the row

1 2 3 4,

and asks me to square them. (I will, in this case again, replace any processes happening 'in the mind' by processes of calculation on the paper.) Suppose, underneath the first row of numbers, I then write:

1 4 9 16.

What I wrote is in accordance with the general rule of squaring; but it obviously is also in accordance with any number of other rules; and amongst these it is not more in accordance with one than with another. In the sense in which before we talked about a rule being involved in a process, *no* rule was involved in this. Supposing that in order to get to my results I calculated 1×1 , 2×2 , 3×3 , 4×4 (that is, in this case wrote down the calculations); these

would again be in accordance with any number of rules. Supposing, on the other hand, in order to get to my results I had written down what you may call "the rule of squaring", say algebraically. In this case this rule was involved in a sense in which no other rule was.

Page 13

We shall say that the rule is *involved* in the understanding, obeying, etc., if, as I should like to express it, the symbol of the rule forms part of the calculation. (As we are not interested in where the processes of thinking, calculating, take place, we can for our purpose imagine the calculations being done entirely on paper. We are not concerned with the difference: internal, external.)

Page 13

A characteristic example of the case B would be one in which the teaching supplied us with a table which we actually make use of in understanding, obeying, etc. If we are taught to play chess, we may be taught rules. If then we play chess, these rules need not be involved in the act of playing. But they may be. Imagine, e.g., that the rules were expressed in the form of a table; in one column the shapes of the chessmen are drawn, and in a parallel column we find diagrams showing the 'freedom' (the legitimate moves) of the pieces. Suppose now that the way the game is played involves making the transition from

Page Break 14

the shape to the possible moves by running one's finger across the table, and then making one of these moves.

Page 14

Teaching as the hypothetical history of our subsequent actions (understanding, obeying, estimating a length, etc.) drops out of our considerations. The rule which has been taught and is subsequently applied interests us only so far as it is involved in the application. A rule, so far as it interests us, does not act at a distance.

Page 14

Suppose I pointed to a piece of paper and said to someone: "this colour I call 'red'". Afterwards I give him the order: "now paint me a red patch". I then ask him: "why, in carrying out my order, did you paint just this colour?" His answer could then be: "This colour (pointing to the sample which I have given him) was called red; and the patch I have painted has, as you see, the colour of the sample". He has now given me a reason for carrying out the order in the way he did. Giving a reason for something one did or said means showing a way which leads to this action. In some cases it means telling the way which one has gone oneself; in others it means describing a way which leads there and is in accordance with certain accepted rules. Thus when asked, "why did you carry out my order by painting just this colour?" the person could have described the way he had actually taken to arrive at this particular shade of colour. This would have been so if, hearing the word "red", he had taken up the sample I had given him, labelled "red", and had *copied* that sample when painting the patch. On the other hand he might have painted it 'automatically' or from a memory image, but when asked to give the reason he might still point to the sample and show that it matched the patch he had painted. In this latter case the reason given would have been of the second kind; i.e. a justification *post hoc*.

Page 14

Now if one thinks that there could be no understanding and obeying the order without a previous teaching, one thinks of the teaching as supplying a *reason* for doing what one did; as supplying the road one walks. Now there is the idea that if an order is understood and obeyed there must be a reason for our obeying it as we do; and, in fact, a chain of reasons reaching back to infinity. This is as if one said: "Wherever you are, you must have got there from somewhere else, and to that previous place from another place; and so on *ad infinitum*". (If, on the other hand, you had said, "wherever you are, you *could* have got there from another place ten yards away; and to that other place from a third, ten yards further away, and so on *ad infinitum*", if you had said this you would have stressed the infinite *possibility* of making a step.

Page Break 15

Thus the idea of an infinite chain of reasons arises out of a confusion similar to this: that a line of a certain length consists of an infinite number of parts because it is indefinitely divisible; i.e., because there is no end to the possibility of dividing it.)

Page 15

If on the other hand you realize that the chain of *actual* reasons has a beginning, you will no longer be revolted by the idea of a case in which there is *no* reason for the way you obey the order. At this point, however, another confusion sets in, that between reason and cause. One is led into this confusion by the ambiguous use of the word "why". Thus when the chain of reasons has come to an end and still the question "why?" is asked, one is inclined to give a cause instead of a reason. If, e.g., to the question, "why did you paint just this colour when I told you to paint a red patch?" you give the answer: "I have been shown a sample of this colour and the word 'red' was

pronounced to me at the same time; and therefore this colour now always comes to my mind when I hear the word 'red' ", then you have given a cause for your action and not a reason.

Page 15

The proposition that your action has such and such a cause, is a hypothesis. The hypothesis is well-founded if one has had a number of experiences which, roughly speaking, agree in showing that your action is the regular sequel of certain conditions which we then call causes of the action. In order to know the reason which you had for making a certain statement, for acting in a particular way, etc., no number of agreeing experiences is necessary, and the statement of your reason is not a hypothesis. The difference between the grammars of "reason" and "cause" is quite similar to that between the grammars of "motive" and "cause". Of the cause one can say that one can't *know* it but can only *conjecture* it. On the other hand one often says: "Surely *I* must know why I did it" talking of the *motive*. When I say: "we can only *conjecture* the cause but we *know* the motive" this statement will be seen later on to be a grammatical one. The "can" refers to a *logical* possibility.

Page 15

The double use of the word "why", asking for the cause and asking for the motive, together with the idea that we can know, and not only conjecture, our motives, gives rise to the confusion that a motive is a cause of which we are immediately aware, a cause 'seen from the inside', or a cause experienced.--Giving a reason is like giving a calculation by which you have arrived at a certain result.

Page 15

Let us go back to the statement that thinking essentially consists in operating with signs. My point was that it is liable to mislead us

Page Break 16

if we say 'thinking is a mental activity'. The question what kind of an activity thinking is is analogous to this: "Where does thinking take place?" We can answer: on paper, in our head, in the mind. None of these statements of locality gives *the* locality of thinking. The use of all these specifications is correct, but we must not be misled by the similarity of their linguistic form into a false conception of their grammar. As, e.g., when you say: "Surely, the *real* place of thought is in our head". The same applies to the idea of thinking as an activity. It is correct to say that thinking is an activity of our writing hand, of our larynx, of our head, and of our mind, so long as we understand the grammar of these statements. And it is, furthermore, extremely important to realize how, by misunderstanding the grammar of our expressions, we are led to think of one in particular of these statements as giving the *real* seat of the activity of thinking.

Page 16

There is an objection to saying that thinking is some such thing as an activity of the hand. Thinking, one wants to say, is part of our 'private experience'. It is not material, but an event in private consciousness. This objection is expressed in the question: "Could a machine think?" I shall talk about this at a later point,†1 and now only refer you to an analogous question: "Can a machine have toothache?" You will certainly be inclined to say: "A machine can't have toothache". All I will do now is to draw your attention to the use which you have made of the word "can" and to ask you: "Did you mean to say that all our past experience has shown that a machine never had toothache?" The impossibility of which you speak is a logical one. The question is: What is the relation between thinking (or toothache) and the subject which thinks, has toothache, etc.? I shall say no more about this now.

Page 16

If we say thinking is essentially operating with signs, the first question you might ask is: "What are signs?"--Instead of giving any kind of general answer to this question, I shall propose to you to look closely at particular cases which we should call "operating with signs". Let us look at a simple example of operating with words. I give someone the order: "fetch me six apples from the grocer", and I will describe a way of making use of such an order: The words "six apples" are written on a bit of paper, the paper is handed to the grocer, the grocer compares the word "apple" with labels on different shelves. He finds it to agree with one of the labels, counts from 1 to the number written on the slip of paper, and for every number counted

Page Break 17

takes a fruit off the shelf and puts it in a bag.--And here you have a case of the use of words. I shall in the future again and again draw your attention to what I shall call language games. These are ways of using signs simpler than those in which we use the signs of our highly complicated everyday language. Language games are the forms of language with which a child begins to make use of words. The study of language games is the study of primitive forms of language or primitive languages. If we want to study the problems of truth and falsehood, of the agreement and disagreement of propositions with reality, of the nature of assertion, assumption, and question, we shall with great

advantage look at primitive forms of language in which these forms of thinking appear without the confusing background of highly complicated processes of thought. When we look at such simple forms of language the mental mist which seems to enshroud our ordinary use of language disappears. We see activities, reactions, which are clear-cut and transparent. On the other hand we recognize in these simple processes forms of language not separated by a break from our more complicated ones. We see that we can build up the complicated forms from the primitive ones by gradually adding new forms.

Page 17

Now what makes it difficult for us to take this line of investigation is our craving for generality.

Page 17

This craving for generality is the resultant of a number of tendencies connected with particular philosophical confusions. There is

Page 17

(a) The tendency to look for something in common to all the entities which we commonly subsume under a general term.--We are inclined to think that there must be something in common to all games, say, and that this common property is the justification for applying the general term "game" to the various games; whereas games form a *family* the members of which have family likenesses. Some of them have the same nose, others the same eyebrows and others again the same way of walking; and these likenesses overlap. The idea of a general concept being a common property of its particular instances connects up with other primitive, too simple, ideas of the structure of language. It is comparable to the idea that *properties* are *ingredients* of the things which have the properties; e.g. that beauty is an ingredient of all beautiful things as alcohol is of beer and wine, and that we therefore could have pure beauty, unadulterated by anything that is beautiful.

Page 17

(b) There is a tendency rooted in our usual forms of expression,

Page Break 18

to think that the man who has learnt to understand a general term, say, the term "leaf", has thereby come to possess a kind of general picture of a leaf, as opposed to pictures of particular leaves. He was shown different leaves when he learnt the meaning of the word "leaf"; and showing him the particular leaves was only a means to the end of producing 'in him' an idea which we imagine to be some kind of general image. We say that he sees what is in common to all these leaves; and this is true if we mean that he can on being asked tell us certain features or properties which they have in common. But we are inclined to think that the general idea of a leaf is something like a visual image, but one which only contains what is common to all leaves. (Galtonian composite photograph.) This again is connected with the idea that the meaning of a word is an image, or a thing correlated to the word. (This roughly means, we are looking at words as though they all were proper names, and we then confuse the bearer of a name with the meaning of the name.)

Page 18

(c) Again, the idea we have of what happens when we get hold of the general idea 'leaf', 'plant', etc. etc., is connected with the confusion between a mental state, meaning a state of a hypothetical mental mechanism, and a mental state meaning a state of consciousness (toothache, etc.).

Page 18

(d) Our craving for generality has another main source: our preoccupation with the method of science. I mean the method of reducing the explanation of natural phenomena to the smallest possible number of primitive natural laws; and, in mathematics, of unifying the treatment of different topics by using a generalization. Philosophers constantly see the method of science before their eyes, and are irresistibly tempted to ask and answer questions in the way science does. This tendency is the real source of metaphysics, and leads the philosopher into complete darkness. I want to say here that it can never be our job to reduce anything to anything, or to explain anything. Philosophy really *is* 'purely descriptive'. (Think of such questions as "Are there sense data?" and ask: What method is there of determining this? Introspection?)

Page 18

Instead of "craving for generality" I could also have said "the contemptuous attitude towards the particular case". If, e.g., someone tries to explain the concept of number and tells us that such and such a definition will not do or is clumsy because it only applies to, say, finite cardinals I should answer that the mere fact that he could have given such a limited definition makes this definition extremely important to

Page Break 19

us. (Elegance is *not* what we are trying for.) For why should what finite and transfinite numbers have in common be more interesting to us than what distinguishes them? Or rather, I should not have said "why should it be more

interesting to us?"--it *isn't*; and this characterizes our way of thinking.

Page 19

The attitude towards the more general and the more special in logic is connected with the usage of the word "kind" which is liable to cause confusion. We talk of kinds of numbers, kinds of propositions, kinds of proofs; and, also, of kinds of apples, kinds of paper, etc. In one sense what defines the kind are properties, like sweetness, hardness, etc. In the other the different kinds are different grammatical structures. A treatise on pomology may be called incomplete if there exist kinds of apples which it doesn't mention. Here we have a standard of completeness in nature. Supposing on the other hand there was a game resembling that of chess but simpler, no pawns being used in it. Should we call this game incomplete? Or should we call a game more complete than chess if it in some way contained chess but added new elements? The contempt for what seems the less general case in logic springs from the idea that it is incomplete. It is in fact confusing to talk of cardinal arithmetic as something special as opposed to something more general. Cardinal arithmetic bears no mark of incompleteness; nor does an arithmetic which is cardinal and finite. (There are no subtle distinctions between logical forms as there are between the tastes of different kinds of apples.)

Page 19

If we study the grammar, say, of the words "wishing", "thinking", "understanding", "meaning", we shall not be dissatisfied when we have described various cases of wishing, thinking, etc. If someone said, "surely this is not all that one calls 'wishing'", we should answer, "certainly not, but you can build up more complicated cases if you like." And after all, there is not one definite class of features which characterize all cases of wishing (at least not as the word is commonly used). If on the other hand you wish to give a definition of wishing, i.e., to draw a sharp boundary, then you are free to draw it as you like; and this boundary will never entirely coincide with the actual usage, as this usage has no sharp boundary.

Page 19

The idea that in order to get clear about the meaning of a general term one had to find the common element in all its applications has shackled philosophical investigation; for it has not only led to no result, but also made the philosopher dismiss as irrelevant the concrete cases, which alone could have helped him to understand the usage of

Page Break 20

the general term. When Socrates asks the question, "what is knowledge?" he does not even regard it as a *preliminary* answer to enumerate cases of knowledge.†1 If I wished to find out what sort of thing arithmetic is, I should be very content indeed to have investigated the case of a finite cardinal arithmetic. For

Page 20

(a) this would lead me on to all the more complicated cases,

Page 20

(b) a finite cardinal arithmetic is not incomplete, it has no gaps which are then filled in by the rest of arithmetic.

Page 20

What happens if from 4 till 4.30 A expects B to come to his room? In one sense in which the phrase "to expect something from 4 to 4.30" is used it certainly does not refer to one process or state of mind going on throughout that interval, but to a great many different activities and states of mind. If for instance I expect B to come to tea, what happens *may* be this: At four o'clock I look at my diary and see the name "B" against today's date; I prepare tea for two; I think for a moment "does B smoke?" and put out cigarettes; towards 4.30 I begin to feel impatient; I imagine B as he will look when he comes into my room. All this is called "expecting B from 4 to 4.30". And there are endless variations to this process which we all describe by the same expression. If one asks what the different processes of expecting someone to tea have in common, the answer is that there is no single feature in common to all of them, though there are many common features overlapping. These cases of expectation form a family; they have family likenesses which are not clearly defined.

Page 20

There is a totally different use of the word "expectation" if we use it to mean a particular sensation. This use of the words like "wish", "expectation", etc., readily suggests itself. There is an obvious connection between this use and the one described above. There is no doubt that in many cases if we expect some one, in the first sense, some, or all, of the activities described are accompanied by a peculiar feeling, a tension; and it is natural to use the word "expectation" to mean this experience of tension.

Page 20

There arises now the question: is this sensation to be called "the sensation of expectation", or "the sensation of expectation that B will come"? In the first case to say that you are in a state of expectation admittedly does not fully describe the situation of expecting that so-and-so will happen. The second case is often rashly suggested as an

explanation of the use of the phrase "expecting that so-and-so will happen", and you may even think that with this explanation you are

Page Break 21

on safe ground, as every further question is dealt with by saying that the sensation of expectation is indefinable.

Page 21

Now there is no objection to calling a particular sensation "the expectation that B will come". There may even be good practical reasons for using such an expression. Only mark:--if we have explained the meaning of the phrase "expecting that B will come" in this way no phrase which is derived from this by substituting a different name for "B" is thereby explained. One might say that the phrase "expecting that B will come" is not a value of a function "expecting that x will come". To understand this compare our case with that of the function "I eat x ". We understand the proposition "I eat a chair" although we weren't specifically taught the meaning of the expression "eating a chair".

Page 21

The role which in our present case the name "B" plays in the expression "I expect B" can be compared with that which the name "Bright" plays in the expression "Bright's disease". †1 Compare the grammar of this word, when it denotes a particular kind of disease, with that of the expression "Bright's disease" when it means the disease which Bright has. I will characterize the difference by saying that the word "Bright" in the first case is an index in the complex *name* "Bright's disease"; in the second case I shall call it an argument of the function " x 's disease". One may say that an index *alludes* to something, and such an allusion may be justified in all sorts of ways. Thus calling a sensation "the expectation that B will come" is giving it a complex name and "B" possibly alludes to the man whose coming had regularly been preceded by the sensation.

Page 21

Again we may use the phrase "expectation that B will come" not as a name but as a characteristic of certain sensations. We might, e.g., explain that a certain tension is said to be an expectation that B will come if it is relieved by B's coming. If this is how we use the phrase then it is true to say that we don't know what we expect until our expectation has been fulfilled (cf. Russell). But no one can believe that this is the only way or even the most common way of using the word "expect". If I ask someone "whom do you expect?" and after receiving the answer ask again "Are you sure that you don't expect someone else?" then, in most cases, this question would be regarded as absurd, and the answer will be something like "Surely, I must know whom I expect".

Page 21

One may characterize the meaning which Russell gives to the word

Page Break 22

"wishing" by saying that it means to him a kind of hunger.--It is a hypothesis that a particular feeling of hunger will be relieved by eating a particular thing. In Russell's way of using the word "wishing" it makes no sense to say "I wished for an apple but a pear has satisfied me". †1 But we do sometimes say this, using the word "wishing" in a way different from Russell's. In this sense we can say that the tension of wishing was relieved without the wish being fulfilled; and also that the wish was fulfilled without the tension being relieved. That is, I may, in this sense, become satisfied without my wish having been satisfied.

Page 22

Now one might be tempted to say that the difference which we are talking about simply comes to this, that in some cases we know what we wish and in others we don't. There are certainly cases in which we say, "I feel a longing, though I don't know what I'm longing for" or, "I feel a fear, but I don't know what I'm afraid of", or again: "I feel fear, but I'm not afraid of anything in particular".

Page 22

Now we may describe these cases by saying that we have certain sensations not referring to objects. The phrase "not referring to objects" introduces a grammatical distinction. If in characterizing such sensations we use verbs like "fearing", "longing", etc., these verbs will be intransitive; "I fear" will be analogous to "I cry". We may cry about something, but what we cry about is not a constituent of the process of crying; that is to say, we could describe all that happens when we cry without mentioning what we are crying about.

Page 22

Suppose now that I suggested we should use the expression "I feel fear", and similar ones, in a transitive way only. Whenever before we said "I have a sensation of fear" (intransitively) we will now say "I am afraid of something, but I don't know of what". Is there an objection to this terminology?

We may say: "There isn't, except that we are then using the word 'to know' in a queer way". Consider this case:--we have a general undirected feeling of fear. Later on, we have an experience which makes us say, "Now I know what I was afraid of. I was afraid of so-and-so happening". Is it correct to describe my first feeling by an intransitive verb, or should I say that my fear had an object although I did not know that it had one? Both these forms of description can be used. To understand this examine the following example: It might be found practical to call a certain state of decay in a tooth, not accompanied by what we commonly call toothache, "unconscious

toothache" and to use in such a case the expression that we have toothache, but don't know it. It is in just this sense that psychoanalysis talks of unconscious thoughts, acts of volition, etc. Now is it wrong in this sense to say that I have toothache but don't know it? There is nothing wrong about it, as it is just a new terminology and can at any time be retranslated into ordinary language. On the other hand it obviously makes use of the word "to know" in a new way. If you wish to examine how this expression is used it is helpful to ask yourself "what in this case is the process of getting to know like?" "What do we call 'getting to know' or, 'finding out'?"

It isn't wrong, according to our new convention, to say "I have unconscious toothache". For what more can you ask of your notation than that it should distinguish between a bad tooth which doesn't give you toothache and one which does? But the new expression misleads us by calling up pictures and analogies which make it difficult for us to go through with our convention. And it is extremely difficult to discard these pictures unless we are constantly watchful; particularly difficult when, in philosophizing, we contemplate what we *say* about things. Thus, by the expression "unconscious toothache" you may either be misled into thinking that a stupendous discovery has been made, a discovery which in a sense altogether bewilders our understanding; or else you may be extremely puzzled by the expression (the puzzlement of philosophy) and perhaps ask such a question as "How is unconscious toothache possible?" You may then be tempted to deny the possibility of unconscious toothache; but the scientist will tell you that it is a proved fact that there is such a thing, and he will say it like a man who is destroying a common prejudice. He will say: "Surely it's quite simple; there are other things which you don't know of, and there can also be toothache which you don't know of. It is just a new discovery". You won't be satisfied, but you won't know what to answer. This situation constantly arises between the scientist and the philosopher.

In such a case we may clear the matter up by saying: "Let's see how the word 'unconscious', 'to know', etc. etc., is used in this case, and how it's used in others". *How far does the analogy between these uses go?* We shall also try to construct new notations, in order to break the spell of those which we are accustomed to.

We said that it was a way of examining the grammar (the use) of the word "to know", to ask ourselves what, in the particular case we are examining, we should call "getting to know". There is a temptation

to think that this question is only vaguely relevant, if relevant at all, to the question: "what is the meaning of the word 'to know'?" We seem to be on a side-track when we ask the question "What is it like in this case 'to get to know'?" But this question really is a question concerning the grammar of the word "to know", and this becomes clearer if we put it in the form: "What do we *call* 'getting to know'?" It is part of the grammar of the word "chair" that *this* is what we call "to sit on a chair", and it is part of the grammar of the word "meaning" that *this* is what we call "explanation of a meaning"; in the same way to explain my criterion for another person's having toothache is to give a grammatical explanation about the word "toothache" and, in this sense, an explanation concerning the meaning of the word "toothache".

When we learnt the use of the phrase "so-and-so has toothache" we were pointed out certain kinds of behaviour of those who were said to have toothache. As an instance of these kinds of behaviour let us take holding your cheek. Suppose that by observation I found that in certain cases whenever these first criteria told me a person had toothache, a red patch appeared on the person's cheek. Supposing I now said to someone "I see A has toothache, he's got a red patch on his cheek". He may ask me "How do you know A has toothache when you see a red patch?" I should then point out that certain phenomena had always coincided with the appearance of the red patch.

Now one may go on and ask: "How do you know that he has got toothache when he holds his cheek?" The

answer to this might be, "I say, *he* has toothache when he holds his cheek because I hold my cheek when I have toothache". But what if we went on asking:--"And why do you suppose that toothache corresponds to his holding his cheek just because your toothache corresponds to your holding your cheek?" You will be at a loss to answer this question, and find that here we strike rock bottom, that is we have come down to conventions. (If you suggest as an answer to the last question that, whenever we've seen people holding their cheeks and asked them what's the matter, they have answered, "I have toothache",-remember that this experience only co-ordinates holding your cheek with saying certain words.)

Page 24

Let us introduce two antithetical terms in order to avoid certain elementary confusions: To the question "How do you know that so-and-so is the case?", we sometimes answer by giving '*criteria*' and sometimes

Page Break 25

by giving '*symptoms*'. If medical science calls angina an inflammation caused by a particular bacillus, and we ask in a particular case "why do you say this man has got angina?" then the answer "I have found the bacillus so-and-so in his blood" gives us the criterion, or what we may call the defining criterion of angina. If on the other hand the answer was, "His throat is inflamed", this might give us a symptom of angina. I call "symptom" a phenomenon of which experience has taught us that it coincided, in some way or other, with the phenomenon which is our defining criterion. Then to say "A man has angina if this bacillus is found in him" is a tautology or it is a loose way of stating the definition of "angina". But to say, "A man has angina whenever he has an inflamed throat" is to make a hypothesis.

Page 25

In practice, if you were asked which phenomenon is the defining criterion and which is a symptom, you would in most cases be unable to answer this question except by making an arbitrary decision *ad hoc*. It may be practical to define a word by taking one phenomenon as the defining criterion, but we shall easily be persuaded to define the word by means of what, according to our first use, was a symptom. Doctors will use names of diseases without ever deciding which phenomena are to be taken as criteria and which as symptoms; and this need not be a deplorable lack of clarity. For remember that in general we don't use language according to strict rules-it hasn't been taught us by means of strict rules, either. *We*, in our discussions on the other hand, constantly compare language with a calculus proceeding according to exact rules.

Page 25

This is a very one-sided way of looking at language. In practice we very rarely use language as such a calculus. For not only do we not think of the rules of usage--of definitions, etc.--while using language, but when we are asked to give such rules, in most cases we aren't able to do so. We are unable clearly to circumscribe the concepts we use; not because we don't know their real definition, but because there is no real 'definition' to them. To suppose that there *must* be would be like supposing that whenever children play with a ball they play a game according to strict rules.

Page 25

When we talk of language as a symbolism used in an exact calculus, that which is in our mind can be found in the sciences and in mathematics. Our ordinary use of language conforms to this standard of exactness only in rare cases. Why then do we in philosophizing constantly compare our use of words with one following exact rules?

Page Break 26

The answer is that the puzzles which we try to remove always spring from just this attitude towards language.

Page 26

Consider as an example the question "What is time?" as Saint Augustine and others have asked it. At first sight what this question asks for is a definition, but then immediately the question arises: "What should we gain by a definition, as it can only lead us to other undefined terms?" And why should one be puzzled just by the lack of a definition of time, and not by the lack of a definition of "chair"? Why shouldn't we be puzzled in all cases where we haven't got a definition? Now a definition often clears up the *grammar* of a word. And in fact it is the grammar of the word "time" which puzzles us. We are only expressing this puzzlement by asking a slightly misleading question, the question: "What is...?" This question is an utterance of unclarity, of mental discomfort, and it is comparable with the question "Why?" as children so often ask it. This too is an expression of a mental discomfort, and doesn't necessarily ask for either a cause or a reason. (Hertz, *Principles of Mechanics*.) Now the puzzlement about the grammar of the word "time" arises from what one might call apparent contradictions in that grammar.

Page 26

It was such a "contradiction" which puzzled Saint Augustine when he argued: How is it possible that one should measure time? For the past can't be measured, as it is gone by; and the future can't be measured because it

has not yet come. And the present can't be measured for it has no extension.

Page 26

The contradiction which here seems to arise could be called a conflict between two different usages of a word, in this case the word "measure". Augustine, we might say, thinks of the process of measuring a *length*: say, the distance between two marks on a travelling band which passes us, and of which we can only see a tiny bit (the present) in front of us. Solving this puzzle will consist in comparing what we mean by "measurement" (the grammar of the word "measurement") when applied to a distance on a travelling band with the grammar of that word when applied to time. The problem may seem simple, but its extreme difficulty is due to the fascination which the analogy between two similar structures in our language can exert on us. (It is helpful here to remember that it is sometimes almost impossible for a child to believe that one word can have two meanings.)

Page 26

Now it is clear that this problem about the concept of time asks for an answer given in the form of strict rules. The puzzle is about rules.--Take another example: Socrates' question "What is knowledge?"

Page Break 27

Here the case is even clearer, as the discussion begins with the pupil giving an example of an exact definition, and then analogous to this a definition of the word "knowledge" is asked for. As the problem is put, it seems that there is something wrong with the ordinary use of the word "knowledge". It appears we don't know what it means, and that therefore, perhaps, we have no right to use it. We should reply: "There is no one exact usage of the word 'knowledge'; but we can make up several such usages, which will more or less agree with the ways the word is actually used".

Page 27

The man who is philosophically puzzled sees a law in the way a word is used, and, trying to apply this law consistently, comes up against cases where it leads to paradoxical results. Very often the way the discussion of such a puzzle runs is this: First the question is asked "What is time?" This question makes it appear that what we want is a definition. We mistakenly think that a definition is what will remove the trouble (as in certain states of indigestion we feel a kind of hunger which cannot be removed by eating). The question is then answered by a wrong definition; say: "Time is the motion of the celestial bodies". The next step is to see that this definition is unsatisfactory. But this only means that we don't use the word "time" synonymously with "motion of the celestial bodies". However in saying that the first definition is wrong, we are now tempted to think that we must replace it by a different one, the correct one.

Page 27

Compare with this the case of the definition of number. Here the explanation that a number is the same thing as a numeral satisfies that first craving for a definition. And it is very difficult not to ask: "Well, if it isn't the numeral, *what is it?*"

Page 27

Philosophy, as we use the word, is a fight against the fascination which forms of expression exert upon us.

Page 27

I want you to remember that words have those meanings which we have given them; and we give them meanings by explanations. I may have given a definition of a word and used the word accordingly, or those who taught me the use of the word may have given me the explanation. Or else we might, by the explanation of a word, mean the explanation which, on being asked, we *are* ready to give. That is, if we are ready to give any explanation; in most cases we aren't. Many words in this sense then don't have a strict meaning. But this is not a defect. To think it is would be like saying that the light of my reading lamp is no real light at all because it has no sharp boundary.

Page 27

Philosophers very often talk about investigating, analysing, the

Page Break 28

meaning of words. But let's not forget that a word hasn't got a meaning given to it, as it were, by a power independent of us, so that there could be a kind of scientific investigation into what the word *really* means. A word has the meaning someone has given to it.

Page 28

There are words with several clearly defined meanings. It is easy to tabulate these meanings. And there are words of which one might say: They are used in a thousand different ways which gradually merge into one another. No wonder that we can't tabulate strict rules for their use.

Page 28

It is wrong to say that in philosophy we consider an ideal language as opposed to our ordinary one. For this

makes it appear as though we thought we could improve on ordinary language. But ordinary language is all right. Whenever we make up 'ideal languages' it is not in order to replace our ordinary language by them; but just to remove some trouble caused in someone's mind by thinking that he has got hold of the exact use of a common word. That is also why our method is not merely to enumerate actual usages of words, but rather deliberately to invent new ones, some of them because of their absurd appearance.

Page 28

When we say that by our method we try to counteract the misleading effect of certain analogies, it is important that you should understand that the idea of an analogy being misleading is nothing sharply defined. No sharp boundary can be drawn round the cases in which we should say that a man was misled by an analogy. The use of expressions constructed on analogical patterns stresses analogies between cases often far apart. And by doing this these expressions may be extremely useful. It is, in most cases, impossible to show an exact point where an analogy begins to mislead us. Every particular notation stresses some particular point of view. If, e.g., we call our investigations "philosophy", this title, on the one hand, seems appropriate, on the other hand it certainly has misled people. (One might say that the subject we are dealing with is one of the heirs of the subject which used to be called "philosophy".) The cases in which particularly we wish to say that someone is misled by a form of expression are those in which we would say: "he wouldn't talk as he does if he were aware of this difference in the grammar of such-and-such words, or if he were aware of this other possibility of expression" and so on. Thus we may say of some philosophizing mathematicians that they are obviously not aware of the difference between the many different usages of the word "proof"; and that they are not clear about

Page Break 29

the difference between the uses of the word "kind", when they talk of kinds of numbers, kinds of proofs, as though the word "kind" here meant the same thing as in the context "kinds of apples". Or, we may say, they are not aware of the different *meanings* of the word "discovery", when in one case we talk of the discovery of the construction of the pentagon and in the other case of the discovery of the South Pole.

Page 29

Now when we distinguished a transitive and an intransitive use of such words as "longing", "fearing", "expecting", etc., we said that some one might try to smooth over our difficulties by saying: "The difference between the two cases is simply that in one case we know what we are longing for and in the other we don't". Now who says this, I think, obviously doesn't see that the difference which he tried to explain away reappears when we carefully consider the use of the word "to know" in the two cases. The expression "the difference is simply..." makes it appear as though we had analysed the case and found a simple analysis; as when we point out that two substances with very different names hardly differ in composition.

Page 29

We said in this case that we might use both expressions: "we feel a longing" (where "longing" is used intransitively) and "we feel a longing and don't know what we are longing for". It may seem queer to say that we may correctly use either of two forms of expression which seem to contradict each other; but such cases are very frequent.

Page 29

Let us use the following example to clear this up. We say that the equation $x^2 = -1$ has the solution $\pm \sqrt{-1}$. There was a time when one said that this equation had no solution. Now this statement, whether agreeing or disagreeing, with the one which told us the solutions, certainly hasn't its multiplicity. But we can easily give it that multiplicity by saying that an equation $x^2 + ax + b = 0$ hasn't got a solution but comes α near to the nearest solution which is β . Analogously we can say either "A straight line always intersects a circle; sometimes in real, sometimes in complex points", or, "A straight line either intersects a circle, or it doesn't and is α far from doing so". These two statements mean exactly the same. They will be more or less satisfactory according to the way a man wishes to look at it. He may wish to make the difference between intersecting and not intersecting as inconspicuous as possible. Or on the other hand he may wish to stress it; and either tendency may be justified, say, by his particular practical purposes. But this may not be the reason at all why he prefers one form of expression to the other. Which form he

Page Break 30

prefers, and whether he has a preference at all, often depends on general, deeply rooted, tendencies of his thinking.

Page 30

(Should we say that there are cases when a man despises another man and doesn't know it; or should we describe such cases by saying that he doesn't despise him but unintentionally behaves towards him in a way--speaks to him in a tone of voice, etc.--which in general would go together with despising him? Either form of expression is

correct; but they may betray different tendencies of the mind.)

Page 30

Let us revert to examining the grammar of the expressions "to wish", "to expect", "to long for", etc., and consider that most important case in which the expression, "I wish so and so to happen" is the direct description of a conscious process. That is to say, the case in which we should be inclined to answer the question "Are you sure that it is this you wish?" by saying: "Surely I must know what I wish". Now compare this answer to the one which most of us would give to the question: "Do you know the ABC?" Has the emphatic assertion that you know it a sense analogous to that of the former assertion? Both assertions in a way brush aside the question. But the former doesn't wish to say "Surely I know such a simple thing as this" but rather: "The question which you asked me makes nonsense". We might say: We adopt in this case a wrong method of brushing aside the question. "Of course I know" could here be replaced by "Of course, there is no doubt" and this interpreted to mean "It makes, in this case, no sense of talk of a doubt". In this way the answer "Of course I know what I wish" can be interpreted to be a grammatical statement.

Page 30

It is similar when we ask, "Has this room a length?", and someone answers: "Of course it has". He might have answered, "Don't ask nonsense".. On the other hand "The room has length" can be used as a grammatical statement. It then says that a sentence of the form "The room is feet long" makes sense.

Page 30

A great many philosophical difficulties are connected with that sense of the expressions "to wish", "to think", etc., which we are now considering. These can all be summed up in the question: "How can one think what is not the case?"

Page 30

This is a beautiful example of a philosophical question. It asks "How can one...?" and while this puzzles us we must admit that nothing is easier than to think what is not the case. I mean, this shows us again that the difficulty which we are in does not arise through our inability to imagine how thinking something is done; just as the

Page Break 31

philosophical difficulty about the measurement of time did not arise through our inability to imagine how time was actually measured. I say this because sometimes it almost seems as though our difficulty were one of remembering exactly what happened when we thought something, a difficulty of introspection, or something of the sort; whereas in fact it arises when we look at the facts through the medium of a misleading form of expression.

Page 31

"How can one think what is not the case? If I think that King's College is on fire when it is not on fire, the fact of its being on fire does not exist. Then how can I think it? How can we hang a thief who doesn't exist?" Our answer could be put in this form: "I can't hang him when he doesn't exist; but I can look for him when he doesn't exist".

Page 31

We are here misled by the substantives "object of thought" and "fact", and by the different meanings of the word "exist".

Page 31

Talking of the fact as a "complex of objects" springs from this confusion (cf. *Tractatus Logico-philosophicus*). Supposing we asked: "How can one *imagine* what does not exist?" The answer seems to be: "If we do, we imagine non-existent combinations of existing elements". A centaur doesn't exist, but a man's head and torso and arms and a horse's legs do exist. "But can't we imagine an object utterly different from any one which exists?"--We should be inclined to answer: "No; the elements, individuals, must exist. If redness, roundness and sweetness did not exist, we could not imagine them".

Page 31

But what do you mean by "redness exists"? My watch exists, if it hasn't been pulled to pieces, if it hasn't been *destroyed*. What would we call "destroying redness"? We might of course mean destroying all red objects; but would this make it impossible to imagine a red object? Supposing to this one answered: "But surely, red objects must have existed and you must have seen them if you are able to imagine them"?--But how do you know that this is so? Suppose I said "Exerting a pressure on your eye-ball produces a red image". Couldn't the way by which you first became acquainted with red have been this? And why shouldn't it have been just imagining a red patch? (The difficulty which you may feel here will have to be discussed at a later occasion. †1)

Page 31

We may now be inclined to say: "As the *fact* which would make our thought true if it existed does not always exist, it is not the fact which we think". But this just depends upon how I wish to use the word

Page Break 32

"fact". Why shouldn't I say: "I believe the fact that the college is on fire"? It is just a clumsy expression for saying: "I believe that the college is on fire". To say "It is not the fact which we believe", is itself the result of a confusion. We think we are saying something like: "It isn't the sugar-cane which we eat but the sugar", "It isn't Mr. Smith who hangs in the gallery, but his picture".

Page 32

The next step we are inclined to take is to think that as the object of our thought isn't the fact it is a shadow of the fact. There are different names for this shadow, e.g. "proposition", "sense of the sentence".

Page 32

But this doesn't remove our difficulty. For the question now is: "How can something be the shadow of a fact which doesn't exist?"

Page 32

I can express our trouble in a different form by saying: "How can we know what the shadow is a shadow of?"--The shadow would be some sort of portrait; and therefore I can restate our problem by asking: "What makes a portrait a portrait of Mr. N?" The answer which might first suggest itself is: "The similarity between the portrait and Mr. N". This answer in fact shows what we had in mind when we talked of the shadow of a fact. It is quite clear, however, that similarity does not constitute our idea of a portrait; for it is in the essence of this idea that it should make sense to talk of a good or a bad portrait. In other words, it is essential that the shadow should be capable of representing things as in fact they are not.

Page 32

An obvious, and correct, answer to the question "What makes a portrait the portrait of so-and-so?" is that it is the *intention*. But if we wish to know what it means "intending this to be a portrait of so-and-so" let's see what actually happens when we intend this. Remember the occasion when we talked of what happened when we expect some one from four to four-thirty. To intend a picture to be the portrait of so-and-so (on the part of the painter, e.g.) is neither a particular state of mind nor a particular mental process. But there are a great many combinations of actions and states of mind which we should call "intending..." It might have been that he was told to paint a portrait of N, and sat down before N, going through certain actions which we call "copying N's face". One might object to this by saying that the essence of copying is the intention to copy. I should answer that there are a great many different processes which we call "copying something". Take an instance. I draw an ellipse on a sheet of paper and ask you to copy it. What characterizes the process of copying? For it is clear that it isn't the fact that you draw a similar

Page Break 33

ellipse. You might have tried to copy it and not succeeded; or you might have drawn an ellipse with a totally different intention, and it happened to be like the one you should have copied. So what do you do when you try to copy the ellipse? Well, you look at it, draw something on a piece of paper, perhaps measure what you have drawn, perhaps you curse if you find it doesn't agree with the model; or perhaps you say "I am going to copy this ellipse" and just draw an ellipse like it. There are an endless variety of actions and words, having a family likeness to each other, which we call "trying to copy".

Page 33

Suppose we said "that a picture is a portrait of a particular object consists in its being derived from that object in a particular way". Now it is easy to describe what we should call processes of deriving a picture from an object (roughly speaking, processes of projection). But there is a peculiar difficulty about admitting that any such process is what we call "intentional representation". For describe whatever process (activity) of projection we may, there is a way of reinterpreting this projection. Therefore--one is tempted to say--such a process can never be the intention itself. For we could always have intended the opposite by reinterpreting the process of projection. Imagine this case: We give someone an order to walk in a certain direction by pointing or by drawing an arrow which points in the direction. Suppose drawing arrows is the language in which generally we give such an order. Couldn't such an order be interpreted to mean that the man who gets it is to walk in the direction opposite to that of the arrow? This could obviously be done by adding to our arrow some symbols which we might call "an *interpretation*". It is easy to imagine a case in which, say to deceive someone, we might make an arrangement that an order should be carried out in the sense opposite to its normal one. The symbol which adds the interpretation to our original arrow could, for instance, be another arrow. Whenever we interpret a symbol in one way or another, the interpretation is a new symbol added to the old one.

Page 33

Now we might say that whenever we give someone an order by showing him an arrow, and don't do it 'mechanically' (without thinking), we *mean* the arrow in one way or another. And this process of meaning, of whatever kind it may be, can be represented by another arrow (pointing in the same or the opposite sense to the first). In this picture which we make of 'meaning and saying' it is essential that we should imagine the processes of saying and meaning to take place in two different spheres.

Page Break 34

Page 34

Is it then correct to say that no arrow could be the meaning, as every arrow could be meant the opposite way?--Suppose we write down the scheme of saying and meaning by a column of arrows one below the other.

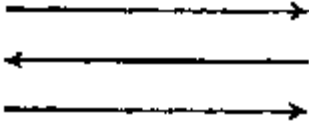

Then if this scheme is to serve our purpose at all, it must show us which of the three levels is the level of meaning. I can, e.g., make a scheme with three levels, the bottom level always being the level of meaning. But adopt whatever model or scheme you may, it will have a bottom level, and there will be no such thing as an interpretation of that. To say in this case that every arrow can still be interpreted would only mean that I *could* always make a different model of saying and meaning which had one more level than the one I am using.

Page 34

Let us put it in this way:--What one wishes to say is: "Every sign is capable of interpretation; but the *meaning* mustn't be capable of interpretation. It is the last interpretation." Now I assume that you take the meaning to be a process accompanying the saying, and that it is translatable into, and so far equivalent to, a further sign. You have therefore further to tell me what you take to be the distinguishing mark between *a sign* and *the meaning*. If you do so, e.g., by saying that the meaning is the arrow which you *imagine* as opposed to any which you may draw or produce in any other way, you thereby say that you will call no further arrow an interpretation of the one which you have imagined.

Page 34

All this will become clearer if we consider what it is that really happens when we say a thing and mean what we say.--Let us ask ourselves: If we say to someone "I should be delighted to see you" and mean it, does a conscious process run alongside these words, a process which could itself be translated into spoken words? This will hardly ever be the case.

Page 34

But let us imagine an instance in which it does happen. Supposing I had a habit of accompanying every English sentence which I said aloud by a German sentence spoken to myself inwardly. If then, for some reason or other, you call the silent sentence the meaning of the one spoken aloud, the process of meaning accompanying the process of saying would be one which could itself be translated into outward signs. Or, *before* any sentence which we say aloud we say its meaning

Page Break 35

(whatever it may be) to ourselves in a kind of aside. An example at least similar to the case we want would be saying one thing and at the same time seeing a picture before our mind's eye which is the meaning and agrees or disagrees with what we say. Such cases and similar ones exist, but they are not at all what happens as a rule when we say something and mean it, or mean something else. There are, of course, real cases in which what we call meaning is a definite conscious process accompanying, preceding, or following the verbal expression and itself a verbal expression of some sort or translatable into one. A typical example of this is the 'aside' on the stage.

Page 35

But what tempts us to think of the meaning of what we say as a process essentially of the kind which we have described is the analogy between the forms of expression:

"to say something"
"to mean something",

which seem to refer to two parallel processes.

Page 35

A process accompanying our words which one might call the "process of meaning them" is the modulation

of the voice in which we speak the words; or one of the processes similar to this, like the play of facial expression. These accompany the spoken words not in the way a German sentence might accompany an English sentence, or writing a sentence accompany speaking a sentence; but in the sense in which the tune of a song accompanies its words. This tune corresponds to the 'feeling' with which we say the sentence. And I wish to point out that this feeling is the expression with which the sentence is said, or something similar to this expression.

Page 35

Let us revert to our question: "What is the object of a thought?" (e.g. when we say, "I think that King's College is on fire").

Page 35

The question as we put it is already the expression of several confusions. This is shown by the mere fact that it almost sounds like a question of physics; like asking: "What are the ultimate constituents of matter?" (It is a typically metaphysical question; the characteristic of a metaphysical question being that we express an unclarity about the grammar of words in the *form* of a scientific question.)

Page 35

One of the origins of our question is the two-fold use of the propositional function "I think x ". We say, "I think that so-and-so will happen" or "that so-and-so is the case", and also "I think just the same *thing* as he"; and we say "I expect him", and also "I expect that he will come". Compare "I expect him" and "I shoot him". We can't

Page Break 36

shoot him if he isn't there. This is how the question arises: "How can we expect something that is not the case?", "How can we expect a fact which does not exist?"

Page 36

The way out of this difficulty seems to be: what we expect is not the fact, but a shadow of the fact; as it were, the next thing to the fact. We have said that this is only pushing the question one step further back. There are several origins to this idea of a shadow. One of them is this: we say "Surely two sentences of different languages can have the same sense"; and we argue, "therefore the sense is not the same as the sentence", and ask the question "What is the sense?" And we make of 'it' a shadowy being, one of the many which we create when we wish to give meaning to substantives to which no material objects correspond.

Page 36

Another source of the idea of a shadow being the object of our thought is this: We imagine the shadow to be a picture the intention of which *cannot be questioned*, that is, a picture which we don't interpret in order to understand it, but which we understand without interpreting it. Now there are pictures of which we should say that we interpret them, that is, translate them into a different kind of picture, in order to understand them; and pictures of which we should say that we understand them immediately, without any further interpretation. If you see a telegram written in cipher, and you know the key to this cipher, you will, in general, not say that you understand the telegram before you have translated it into ordinary language. Of course you have only replaced one kind of symbols by another; and yet if now you read the telegram in your language no further process of interpretation will take place.--Or rather, you may now, in certain cases, again translate this telegram, say into a picture; but then too you have only replaced one set of symbols by another.

Page 36

The shadow, as we think of it, is some sort of a picture; in fact, something very much like an image which comes before our mind's eye; and this again is something not unlike a painted representation in the ordinary sense. A source of the idea of the shadow certainly is the fact that in some cases saying, hearing, or reading a sentence brings images before our mind's eye, images which more or less strictly correspond to the sentence, and which are therefore, in a sense, translations of this sentence into a pictorial language.--But it is absolutely essential for the picture which we imagine the shadow to be that it is what I shall call a "picture by similarity". I don't mean by this that it is a picture similar to what it is intended to

Page Break 37

represent, but that it is a picture which is correct only when it is similar to what it represents. One might use for this kind of picture the word "copy". Roughly speaking, copies are good pictures when they can easily be mistaken for what they represent.

Page 37

A plane projection of one hemisphere of our terrestrial globe is not a picture by similarity or a copy in this sense. It would be conceivable that I portrayed some one's face by projecting it in some queer way, though correctly according to the adopted rule of projection, on a piece of paper, in such a way that no one would normally call the projection "a good portrait of so-and-so" because it would not look a bit like him.

If we keep in mind the possibility of a picture which, though correct, has no similarity with its object, the interpolation of a shadow between the sentence and reality loses all point. For now the sentence itself can serve as such a shadow. The sentence is just such a picture, which hasn't the slightest similarity with what it represents. If we were doubtful about how the sentence "King's College is on fire" can be a picture of King's College on fire, we need only ask ourselves: "How should we explain what the sentence means?" Such an explanation might consist of ostensive definitions. We should say, e.g., "this is King's College" (pointing to the building), "this is a fire" (pointing to a fire). This shews you the way in which words and things may be connected.

The idea that that which we wish to happen must be present as a shadow in our wish is deeply rooted in our forms of expression. But, in fact, we might say that it is only the next best absurdity to the one which we should really like to say. If it weren't too absurd we should say that the fact which we wish for must be present in our wish. For how can we wish *just this* to happen if just this isn't present in our wish? It is quite true to say: The mere shadow won't do; for it stops short before the object; and we want the wish to contain the object itself.--We want that the wish that Mr. Smith should come into this room should wish that just *Mr. Smith*, and no substitute, should do the *coming*, and no substitute for that, *into my room*, and no substitute for that. But this is exactly what we said.

Our confusion could be described in this way: Quite in accordance with our usual form of expression we think of the fact which we wish for as a thing which is not yet here, and to which, therefore, we cannot point. Now in order to understand the grammar of our expression "object of our wish" let's just consider the answer which we give

to the question: "What is the object of your wish?" The answer to this question of course is "I wish that so-and-so should happen". Now what would the answer be if we went on asking: "And what is the object of this wish?" It could only consist in a repetition of our previous expression of the wish, or else in a translation into some other form of expression. We might, e.g., state what we wished in other words or illustrate it by a picture, etc., etc. Now when we are under the impression that what we call the object of our wish is, as it were, a man who has not yet entered our room, and therefore can't yet be seen, we imagine that any explanation of what it is we wish is only the next best thing to the explanation which would show *the actual fact*--which, we are afraid, can't yet be shown as it has not yet entered.--It is as though I said to some one "I am expecting Mr. Smith", and he asked me "Who is Mr. Smith?", and I answered, "I can't show him to you now, as he isn't there. All I can show you is a picture of him". It then seems as though I could never entirely explain what I wished until it had actually happened. But of course this is a delusion. The truth is that I needn't be able to give a better explanation of what I wished after the wish was fulfilled than before; for I might perfectly well have shown Mr. Smith to my friend, and have shown him what "coming in" means, and have shown him what my room is, before Mr. Smith came into my room.

Our difficulty could be put this way: We think about things,--but how do these things enter into our thoughts? We think about Mr. Smith; but Mr. Smith need not be present. A picture of him won't do; for how are we to know whom it represents? In fact no substitute for hint will do. Then how can he himself be an object of our thoughts? (I am here using the expression "object of our thought" in a way different from that in which I have used it before. I mean now a thing I am thinking *about*, not 'that which I am thinking'.)

We said the connection between our thinking, or speaking, about a man and the man himself was made when, in order to explain the meaning of the word "Mr. Smith" we pointed to him, saying "this is Mr. Smith". And there is nothing mysterious about this connection. I mean, there is no queer mental act which somehow conjures up Mr. Smith in our minds when he really isn't here. What makes it difficult to see that this is the connection is a peculiar form of expression of ordinary language, which makes it appear that the connection between our thought (or the expression of our thought) and the thing we think about must have subsisted *during* the act of thinking.

"Isn't it queer that in Europe we should be able to mean someone who is in America?"--If someone had said "Napoleon was crowned in 1804", and we asked him "Did you mean the man who won the battle of Austerlitz?" he might say "Yes, I meant him". And the use of the past tense "meant" might make it appear as though the idea of Napoleon having won the battle of Austerlitz must have been present in the man's mind when he said that Napoleon was crowned in 1804.

Someone says, "Mr. N. will come to see me this afternoon"; I ask "Do you mean him?" pointing to someone present, and he answers "Yes". In this conversation a connection was established between the word "Mr. N." and Mr. N. But we are tempted to think that while my friend said, "Mr. N. will come to see me", and meant what he said, his mind must have made the connection.

Page 39

This is partly what makes us think of meaning or thinking as a peculiar *mental activity*; the word "mental" indicating that we mustn't expect to understand how these things work.

Page 39

What we said of thinking can also be applied to imagining. Someone says, he imagines King's College on fire. We ask him: "How do you know that it's *King's College* you imagine on fire? Couldn't it be a different building, very much like it? In fact, is your imagination so absolutely exact that there might not be a dozen buildings whose representation your image could be?"--And still you say: "There's no doubt I imagine King's College and no other building". But can't saying this be making the very connection we want? For saying it is like writing the words "Portrait of Mr. So-and-so" under a picture. It might have been that *while* you imagined King's College on fire you said the words "King's College is on fire". But in very many cases you certainly don't speak explanatory words in your mind while you have the image. And consider, even if you do, you are not going the whole way from your image to King's College, but only to the words "King's College". The connection between these words and King's College was, perhaps, made at another time.

Page 39

The fault which in all our reasoning about these matters we are inclined to make is to think that images and experiences of all sorts, which are in some sense closely connected with each other, must be present in our mind at the same time. If we sing a tune we know by heart, or say the alphabet, the notes or letters seem to hang together, and each seems to draw the next after it, as though they were a string of

Page Break 40

pearls in a box, and by pulling out one pearl I pulled out the one following it.

Page 40

Now there is no doubt that, having the visual image of a string of beads being pulled out of a box through a hole in the lid, we should be inclined to say: "These beads must all have been together in the box before". But it is easy to see that this is making a hypothesis. I should have had the same image if the beads had gradually come into existence in the hole of the lid. We easily overlook the distinction between stating a conscious mental event, and making a hypothesis about what one might call the mechanism of the mind. All the more as such hypotheses or pictures of the working of our mind are embodied in many of the forms of expression of our everyday language. The past tense "meant" in the sentence "I meant the man who won the battle of Austerlitz" is part of such a picture, the mind being conceived as a place in which what we remember is kept, stored, before we express it. If I whistle a tune I know well and am interrupted in the middle, if then someone asks me "did you know how to go on?" I should answer "yes, I did". What sort of process is this *knowing how to go on*? It might appear as though the whole continuation of the tune had to be present while I knew how to go on.

Page 40

Ask yourself such a question as: "How long does it take to know how to go on?" Or is it an instantaneous process? Aren't we making a mistake like mixing up the existence of a gramophone record of a tune with the existence of the tune? And aren't we assuming that whenever a tune passes through existence there must be some sort of a gramophone record of it from which it is played?

Page 40

Consider the following example: A gun is fired in my presence and I say: "This crash wasn't as loud as I had expected". Someone asks me: "How is this possible? Was there a crash, louder than that of a gun, in your imagination?" I must confess that there was nothing of the sort. Now he says: "Then you didn't really expect a louder crash-but perhaps the shadow of one.--And how did you know that it was the shadow of a louder crash?"--Let's see what, in such a case, might really have happened. Perhaps in waiting for the report I opened my mouth, held on to something to steady myself, and perhaps I said: "This is going to be terrible". Then, when the explosion was over: "It wasn't so loud after all".--Certain tensions in my body relax. But what is the connection between these tensions, opening my mouth, etc., and a real louder crash? Perhaps this connection

Page Break 41

was made by having heard such a crash and having had the experiences mentioned.

Page 41

Examine expressions like "having an idea in one's mind", "analysing the idea before one's mind". In order not

to be misled by them see what really happens when, say, in writing a letter you are looking for the words which correctly express the idea which is "before your mind". To say that we are trying to express the idea which is before our mind is to use a metaphor, one which very naturally suggests itself; and which is all right so long as it doesn't mislead us when we are philosophizing. For when we recall what really happens in such cases we find a great variety of processes more or less akin to each other.--We might be inclined to say that in all such cases, at any rate, we are *guided* by something before our mind. But then the words "guided" and "thing before our mind" are used in as many senses as the words "idea" and "expression of an idea".

Page 41

The phrase "to express an idea which is before our mind" suggests that what we are trying to express in words is already expressed, only in a different language; that this expression is before our mind's eye; and that what we do is to translate from the mental into the verbal language. In most cases which we call "expressing an idea, etc." something very different happens. Imagine what it is that happens in cases such as this: I am groping for a word. Several words are suggested and I reject them. Finally one is proposed and I say: "That is what I meant!"

Page 41

(We should be inclined to say that the proof of the impossibility of trisecting the angle with ruler and compasses analyses our idea of the trisection of an angle. But the proof gives us a new idea of trisection, one which we didn't have before the proof constructed it. The proof led us a road *which we were inclined to go*; but it led us away from where we were, and didn't just show us clearly the place where we had been all the time.)

Page 41

Let us now revert to the point where we said that we gained nothing by assuming that a shadow must intervene between the expression of our thought and the reality with which our thought is concerned. We said that if we wanted a picture of reality the sentence itself *is* such a picture (though not a picture by similarity).

Page 41

I have been trying in all this to remove the temptation to think that there '*must* be' what is called a mental process of thinking, hoping, wishing, believing, etc., independent of the process of expressing a thought, a hope, a wish, etc. And I want to give you the following

Page Break 42

rule of thumb: If you are puzzled about the nature of thought, belief, knowledge, and the like, substitute for the thought the expression of the thought, etc. The difficulty which lies in this substitution, and at the same time the whole point of it, is this: the expression of belief, thought, etc., is just a sentence;--and the sentence has sense only as a member of a system of language; as one expression within a calculus. Now we are tempted to imagine this calculus, as it were, as a permanent background to every sentence which we say, and to think that, although the sentence as written on a piece of paper or spoken stands isolated, in the mental act of thinking the calculus is there--all in a lump. The mental act seems to perform in a miraculous way what could not be performed by any act of manipulating symbols. Now when the temptation to think that in some sense the whole calculus must be present at the same time vanishes, there is no more point in *postulating* the existence of a peculiar kind of mental act alongside of our expression. This, of course, doesn't mean that we have shown that peculiar acts of consciousness do not accompany the expressions of our thoughts! Only we no longer say that they *must* accompany them.

Page 42

"But the expression of our thoughts can always lie, for we may say one thing and mean another". Imagine the many different things which happen when we say one thing and mean another!--Make the following experiment: say the sentence "It is hot in this room", and mean: "it is cold". Observe closely what you are doing.

Page 42

We could easily imagine beings who do their private thinking by means of 'asides' and who manage their lies by saying one thing aloud, following it up by an aside which says the opposite.

Page 42

"But meaning, thinking, etc., are private experiences. They are not activities like writing, speaking, etc."--But why shouldn't they be the specific private experiences of writing--the muscular, visual, tactile sensations of writing or speaking?

Page 42

Make the following experiment: say and mean a sentence, e.g.: "It will probably rain tomorrow". Now think the same thought again, mean what you just meant, but without saying anything (either aloud or to yourself). If thinking that it will rain tomorrow accompanied saying that it will rain tomorrow, then just do the first activity and leave out the second.--If thinking and speaking stood in the relation of the words and the melody of a song, we could leave out the speaking and do the thinking just as we can sing the tune without the words.

But can't one at any rate speak and leave out the thinking? Certainly--but observe what sort of thing you are doing if you speak without thinking. Observe first of all that the process which we might call "speaking and meaning what you speak" is not necessarily distinguished from that of speaking thoughtlessly by what happens *at the time when you speak*. What distinguishes the two may very well be what happens before or after you speak.

Suppose I tried, deliberately, to speak without thinking;--what in fact would I do? I might read out a sentence from a book, trying to read it automatically, that is, trying to prevent myself from following the sentence with images and sensations which otherwise it would produce. A way of doing this would be to concentrate my attention on something else while I was speaking the sentence, e.g., by pinching my skin hard while I was speaking.--Put it this way: Speaking a sentence without thinking consists in switching on speech and switching off certain accompaniments of speech. Now ask yourself: Does thinking the sentence without speaking it consist in turning over the switch (switching on what we previously switched off and vice versa); that is: does thinking the sentence without speaking it now simply consist in keeping on what accompanied the words but leaving out the words? Try to think the thoughts of a sentence without the sentence and see whether this is what happens.

Let us sum up: If we scrutinize the usages which we make of such words as "thinking", "meaning", "wishing", etc., going through this process rids us of the temptation to look for a peculiar act of thinking, independent of the act of expressing our thoughts, and stowed away in some peculiar medium. We are no longer prevented by the established forms of expression from recognizing that the experience of thinking *may* be just the experience of saying, or may consist of this experience plus others which accompany it. (It is useful also to examine the following case: Suppose a multiplication is part of a sentence; ask yourself what it is like to say the multiplication $7 \times 5 = 35$, thinking it, and, on the other hand, saying it without thinking.) The scrutiny of the grammar of a word weakens the position of certain fixed standards of our expression which had prevented us from seeing facts with unbiassed eyes. Our investigation tried to remove this bias, which forces us to think that the facts *must* conform to certain pictures embedded in our language.

"Meaning" is one of the words of which one may say that they have odd jobs in our language. It is these words which cause most

philosophical troubles. Imagine some institution: most of its members have certain regular functions, functions which can easily be described, say, in the statutes of the institution. There are, on the other hand, some members who are employed for odd jobs, which nevertheless may be extremely important.--What causes most trouble in philosophy is that we are tempted to describe the use of important 'odd-job' words as though they were words with regular functions.

The reason I postponed talking about personal experience was that thinking about this topic raises a host of philosophical difficulties which threaten to break up all our commonsense notions about what we should commonly call the objects of our experience. And if we were struck by these problems it might seem to us that all we have said about signs and about the various objects we mentioned in our examples may have to go into the melting-pot.

The situation in a way is typical in the study of philosophy; and one sometimes has described it by saying that no philosophical problem can be solved until all philosophical problems are solved; which means that as long as they aren't all solved every new difficulty renders all our previous results questionable. To this statement we can only give a rough answer if we are to speak about philosophy in such general terms. It is, that every new problem which arises may put in question the *position* which our previous partial results are to occupy in the final picture. One then speaks of having to reinterpret these previous results; and we should say: they have to be placed in a different surrounding.

Imagine we had to arrange the books of a library. When we begin the books lie higgledy-piggledy on the floor. Now there would be many ways of sorting them and putting them in their places. One would be to take the books one by one and put each on the shelf in its right place. On the other hand we might take up several books from the floor and put them in a row on a shelf, merely in order to indicate that these books ought to go together in this order. In the course of arranging the library this whole row of books will have to change its place. But it would be wrong to say that therefore putting them together on a shelf was no step towards the final result. In this case, in

fact, it is pretty obvious that having put together books which belong together was a definite achievement, even though the whole row of them had to be shifted. But some of the greatest achievements in philosophy could only be compared with taking up some books which seemed to belong together, and putting them on different

Page Break 45

shelves; nothing more being final about their positions than that they no longer lie side by side. The onlooker who doesn't know the difficulty of the task might well think in such a case that nothing at all had been achieved.--The difficulty in philosophy is to say no more than we know. E.g., to see that when we have put two books together in their right order we have not thereby put them in their final places.

Page 45

When we think about the relation of the objects surrounding us to our personal experiences of them, we are sometimes tempted to say that these personal experiences are the material of which reality consists. How this temptation arises will become clearer later on.

Page 45

When we think in this way we seem to lose our firm hold on the objects surrounding us. And instead we are left with a lot of separate personal experiences of different individuals. These personal experiences again seem vague and seem to be in constant flux. Our language seems not to have been made to describe them. We are tempted to think that in order to clear up such matters philosophically our ordinary language is too coarse, that we need a more subtle one.

Page 45

We seem to have made a discovery--which I could describe by saying that the ground on which we stood and which appeared to be firm and reliable was found to be boggy and unsafe.--That is, this happens when we philosophize; for as soon as we revert to the standpoint of common sense this *general* uncertainty disappears.

Page 45

This queer situation can be cleared up somewhat by looking at an example; in fact a kind of parable illustrating the difficulty we are in, and also showing the way out of this sort of difficulty: We have been told by popular scientists that the floor on which we stand is not solid, as it appears to common sense, as it has been discovered that the wood consists of particles filling space so thinly that it can almost be called empty. This is liable to perplex us, for in a way of course we know that the floor is solid, or that, if it isn't solid, this may be due to the wood being rotten but not to its being composed of electrons. To say, on this latter ground, that the floor is not solid is to misuse language. For even if the particles were as big as grains of sand, and as close together as these are in a sandheap, the floor would not be solid if it were composed of them in the sense in which a sandheap is composed of grains. Our perplexity was based on a misunderstanding; the picture of the thinly filled space had been wrongly *applied*. For this picture of the structure of matter was meant to explain the very phenomenon of solidity.

Page 45

As in this example the word "solidity" was used wrongly and it

Page Break 46

seemed that we had shown that nothing really was solid, just in this way, in stating our puzzles about the *general vagueness* of sense-experience, and about the flux of all phenomena, we are using the words "flux" and "vagueness" wrongly, in a typically metaphysical way, namely without an antithesis; whereas in their correct and everyday use vagueness is opposed to clearness, flux to stability, inaccuracy to accuracy, and *problem* to *solution*. The very word "problem", one might say, is misapplied when used for our philosophical troubles. These difficulties, as long as they are seen as problems, are tantalizing, and appear insoluble.

Page 46

There is a temptation for me to say that only my own experience is real: "I know that I see, hear, feel pains, etc., but not that anyone else does. I can't know this, because I am I and they are they."

Page 46

On the other hand I feel ashamed to say to anyone that my experience is the only real one; and I know that he will reply that he could say exactly the same thing about his experience. This seems to lead to a silly quibble. Also I am told: "If you pity someone for having pains, surely you must at least *believe* that he has pains". But how can I even *believe* this? How can these words make sense to me? How could I even have come by the idea of another's experience if there is no possibility of any evidence for it?

Page 46

But wasn't this a queer question to ask? *Can't* I believe that someone else has pains? Is it not quite easy to believe this?--Is it an answer to say that things are as they appear to common sense?--Again, needless to say, we don't feel these difficulties in ordinary life. Nor is it true to say that we feel them when we scrutinize our experiences

by introspection, or make scientific investigations about them. But somehow, when we look at them in a certain way, our expression is liable to get into a tangle. It seems to us as though we had either the wrong pieces, or not enough of them, to put together our jigsaw puzzle. But they *are* all there, only all mixed up; and there is a further analogy between the jig-saw puzzle and our case: It's no use trying to apply force in fitting pieces together. All we should do is to look at them *carefully* and arrange them.

Page 46

There are propositions of which we may say that they describe facts in the material world (external world). Roughly speaking, they treat of physical objects: bodies, fluids, etc. I am not thinking in particular of the laws of the natural sciences, but of any such proposition as "the tulips in our garden are in full bloom", or "Smith will come in any moment". There are on the other hand propositions

Page Break 47

describing personal experiences, as when the subject in a psychological experiment describes his sense-experiences; say his visual experience, independent of what bodies are actually before his eyes and, *n.b.*, independent also of any processes which might be observed to take place in his retina, his nerves, his brain, or other parts of his body. (That is, independent of both physical and physiological facts.)

Page 47

At first sight it may appear (but why it should can only become clear later) that here we have two kinds of worlds, worlds built of different materials; a mental world and a physical world. The mental world in fact is liable to be imagined as gaseous, or rather, aethereal. But let me remind you here of the queer role which the gaseous and the aethereal play in philosophy,--when we perceive that a substantive is not used as what in general we should call the name of an object, and when therefore we can't help saying to ourselves that it is the name of an aethereal object. I mean, we already know the idea of 'aethereal objects' as a subterfuge, when we are embarrassed about the grammar of certain words, and when all we know is that they are not used as names for material objects. This is a hint as to how the problem of the two materials, *mind* and *matter*, is going to dissolve.

Page 47

It seems to us sometimes as though the phenomena of personal experience were in a way phenomena in the upper strata of the atmosphere as opposed to the material phenomena which happen on the ground. There are views according to which these phenomena in the upper strata arise when the material phenomena reach a certain degree of complexity. E.g., that the mental phenomena, sense experience, volition, etc., emerge when a type of animal body of a certain complexity has been evolved. There seems to be some obvious truth in this, for the amoeba certainly doesn't speak or write or discuss, whereas we do. On the other hand the problem here arises which could be expressed by the question: "Is it possible for a machine to think?" (whether the action of this machine can be described and predicted by the laws of physics or, possibly, only by laws of a different kind applying to the behaviour of organisms). And the trouble which is expressed in this question is not really that we don't yet know a machine which could do the job. The question is not analogous to that which someone might have asked a hundred years ago: "Can a machine liquefy a gas?" The trouble is rather that the sentence, "A machine thinks (perceives, wishes)": seems somehow nonsensical. It is as though we had asked "Has the number 3 a colour?" ("What colour could it be, as it obviously has none of the colours known to

Page Break 48

us?") For in one aspect of the matter, personal experience, far from being the *product* of physical, chemical, physiological processes, seems to be the very *basis* of all that we say with any sense about such processes. Looking at it in this way we are inclined to use our idea of a building-material in yet another misleading way, and to say that the whole world, mental and physical, is made of one material only.

Page 48

When we look at everything that we know and can say about the world as resting upon personal experience, then what we know seems to lose a good deal of its value, reliability, and solidity. We are then inclined to say that it is all "subjective"; and "subjective" is used derogatorily, as when we say that an opinion is *merely* subjective, a matter of taste. Now, that this aspect should seem to shake the authority of experience and knowledge points to the fact that here our language is tempting us to draw some misleading analogy. This should remind us of the case when the popular scientist appeared to have shown us that the floor which we stand on is not really solid because it is made up of electrons.

Page 48

We are up against trouble caused by our way of expression.

Page 48

Another such trouble, closely akin, is expressed in the sentence: "I can only know that I have personal

experiences, not that anyone else has".--Shall we then call it an unnecessary hypothesis that anyone else has personal experiences?--But is it an hypothesis at all? For how can I even make the hypothesis if it transcends all possible experience? How could such a hypothesis be backed by meaning? (Is it not like paper money, not backed by gold?)--It doesn't help if anyone tells us that, though we don't know whether the other person has pains, we certainly believe it when, for instance, we pity him. Certainly we shouldn't pity him if we didn't believe that he had pains; but is this a philosophical, a metaphysical belief? Does a realist pity me more than an idealist or a solipsist?--In fact the solipsist asks: "How *can* we believe that the other has pain; what does it mean to believe this? How can the expression of such a supposition make sense?"

Page 48

Now the answer of the common-sense philosopher--and that, *n.b.*, is not the commonsense man, who is as far from realism as from idealism--the answer of the common-sense philosopher is that surely there is no difficulty in the idea of supposing, thinking, imagining that someone else has what I have. But the trouble with the realist is always that he does not solve but skip the difficulties which his adversaries see, though they too don't succeed in solving them. The

Page Break 49

realist answer, for us, just brings out the difficulty; for who argues like this overlooks the difference between different usages of the words "to have", "to imagine". "A has a gold tooth" means that the tooth is in A's mouth. This may account for the fact that I am not able to see it. Now the case of his toothache, of which I say that I am not able to feel it because it is in his mouth, is not analogous to the case of the gold tooth. It is the apparent analogy, and again the lack of analogy, between these cases which causes our trouble. And it is this troublesome feature in our grammar which the realist does not notice. It is conceivable that I feel pain in a tooth in another man's mouth; and the man who says that he cannot feel the other's toothache is not denying *this*. The grammatical difficulty which we are in we shall only see clearly if we get familiar with the idea of feeling pain in another person's body. For otherwise, in puzzling about this problem, we shall be liable to confuse our metaphysical proposition "I can't feel his pain" with the experiential proposition, "We can't have (haven't as a rule) pains in another person's tooth". In this proposition the word "can't" is used in the same way as in the proposition "An iron nail can't scratch glass". (We could write this in the form "experience teaches that an iron nail *doesn't* scratch glass", thus doing away with the "can't".) In order to see that it is conceivable that one person should have pain in another person's body, one must examine what sort of facts we call criteria for a pain being in a certain place. It is easy to imagine the following case: When I see my hands I am not always aware of their connection with the rest of my body. That is to say, I often see my hand moving but don't see the arm which connects it to my torso. Nor do I necessarily, at the time, check up on the arm's existence in any other way. Therefore the hand may, for all I know, be connected to the body of a man standing beside me (or, of course, not to a human body at all). Suppose I feel a pain which on the evidence of the pain alone, e.g., with closed eyes, I should call a pain in my left hand. Someone asks me to touch the painful spot with my right hand. I do so and looking round perceive that I am touching my neighbour's hand (meaning the hand connected to my neighbour's torso).

Page 49

Ask yourself: How do we know where to point to when we are asked to point to the painful spot? Can this sort of pointing be compared with pointing to a black spot on a sheet of paper when someone says: "Point to the black spot on this sheet"? Suppose someone said "You point to this spot because you know before you point that the

Page Break 50

pains are there"; ask yourself "What does it mean to *know* that the pains are there?" The word "there" refers to a locality;--but in what space, i.e., a 'locality' in what sense? Do we know the place of pain in Euclidean space, so that when we know where we have pains we know how far away from two of the walls of this room, and from the floor? When I have pain in the tip of my finger and touch my tooth with it, is my pain now both a toothache and a pain in my finger? Certainly, in one sense the pain can be said to be located on the tooth. Is the reason why in this case it is wrong to say I have toothache, that in order to be in the tooth the pain should be one sixteenth of an inch away from the tip of my finger? Remember that the word "where" can refer to localities in many different senses. (Many different grammatical games, resembling each other *more* or *less*, are played with this word. Think of the different uses of the numeral "1".) I may know where a thing is and then point to it by virtue of that knowledge. The knowledge tells me where to point to. We here conceived this knowledge as the condition for deliberately pointing to the object. Thus one can say: "I can point to the spot you mean because I see it", "I can direct you to the place because I know where it is; first turning to the right, etc." Now one is inclined to say "I must know where a thing is before I can point to it". Perhaps you will feel less happy about saying: "I must know where a thing is before I can

look at it". Sometimes of course it is correct to say this. But we are tempted to think that there is one particular psychical state or event, the knowledge of the place, which must precede every deliberate act of pointing, moving towards, etc. Think of the analogous case: "One can only obey an order after having understood it".

Page 50

If I point to the painful spot on my arm, in what sense can I be said to have known where the pain was before I pointed to the place? Before I pointed I could have said "The pain is in my left arm". Supposing my arm had been covered with a meshwork of lines numbered in such a way that I could refer to any place on its surface. Was it necessary that I should have been able to describe the painful spot by means of these coordinates before I could point to it? What I wish to say is that the act of pointing *determines* a place of pain. This act of pointing, by the way, is not to be confused with that of finding the painful spot by probing. In fact the two may lead to different results.

Page 50

An innumerable variety of cases can be thought of in which we should say that someone has pains in another person's body; or, say,

Page Break 51

in a piece of furniture, or in any empty spot. Of course we mustn't forget that a pain in a particular part of our body, e.g., in an upper tooth, has a peculiar tactile and kinaesthetic neighbourhood. Moving our hand upward a little distance we touch our eye; and the word "little distance" here refers to tactile distance or kinaesthetic distance, or both. (It is easy to imagine tactile and kinaesthetic distances correlated in ways different from the usual. The distance from our mouth to our eye might seem very great 'to the muscles of our arm' when we move our finger from the mouth to the eye. Think how large you imagine the cavity in your tooth when the dentist is drilling and probing it.)

Page 51

When I said that if we moved our hand upward a little, we touch our eye, I was referring to tactile evidence only. That is, the criterion for my finger touching my eye was to be only that I had the particular feeling which would have made me say that I was touching my eye, even if I had no visual evidence for it, and even if, on looking into a mirror, I saw my finger not touching my eye, but, say, my forehead. Just as the 'little distance' I referred to was a tactile or kinaesthetic one, so also the places of which I said, "they lie a little distance apart" were tactile places. To say that my finger in tactile and kinaesthetic space moves from my tooth to my eye then means that I have those tactile and kinaesthetic experiences which we normally have when we say "my finger moves from my tooth to my eye". But what we regard as evidence for this latter proposition is, as we all know, by no means only tactile and kinaesthetic. In fact if I had the tactile and kinaesthetic sensations referred to, I might still deny the proposition "my finger moves etc...." because of what I saw. That proposition is a proposition about physical objects. (And now don't think that the expression "physical objects" is meant to distinguish one kind of object from another.) The grammar of propositions which we call propositions about physical objects admits of a variety of evidences for every such proposition. It characterizes the grammar of the proposition "my finger moves, etc." that I regard the propositions "I see it move", "I feel it move", "He sees it move", "He tells me that it moves", etc. as evidences for it. Now if I say "I see my hand move", this at first sight seems to presuppose that I agree with the proposition "my hand moves". But if I regard the proposition "I see my hand move" as one of the evidences for the proposition "my hand moves", the truth of the latter is, of course, not presupposed in the truth of the former. One might therefore suggest the expression "It looks as

Page Break 52

though my hand were moving" instead of "I see my hand moving". But this expression, although it indicates that my hand may appear to be moving without really moving, might still suggest that after all there must be a hand in order that it should appear to be moving; whereas we could easily imagine cases in which the proposition describing the visual evidence is true and at the same time other evidences make us say that I have no hand. Our ordinary way of expression obscures this. We are handicapped in ordinary language by having to describe, say, a tactile sensation by means of terms for physical objects such as the word "eye", "finger", etc., when what we want to say does not entail the existence of an eye or finger, etc.. We have to use a roundabout description of our sensations. This of course does not mean that ordinary language is insufficient for our special purposes, but that it is slightly cumbersome and sometimes misleading. The reason for this peculiarity of our language is of course the regular coincidence of certain sense experiences. Thus when I feel my arm moving I mostly also can see it moving. And if I touch it with my hand, also that hand feels the motion, etc. (The man whose foot has been amputated will describe a particular pain as pain in his foot.) We feel in such cases a strong need for such an expression as: "a sensation travels from my tactual cheek to my tactual eye". I said all this because, if you are aware of the tactual and kinaesthetic environment of a pain, you may find a difficulty in imagining that one could have toothache anywhere else than in one's own teeth. But if we imagine such a case, this simply means that we imagine a correlation between visual, tactual, kinaesthetic,

etc., experiences different from the ordinary correlation. Thus we can imagine a person having the sensation of toothache plus those tactual and kinaesthetic experiences which are normally bound up with seeing his hand travelling from *his* tooth to his nose, to his eyes, etc., but correlated to the visual experience of his hand moving to those places in another person's face. Or again, we can imagine a person having the kinaesthetic sensation of moving his hand, and the tactual sensation, in his fingers and face, of his fingers moving over his face, whereas his kinaesthetic and visual sensations should have to be described as those of his fingers moving over his knee. If we had a sensation of toothache plus certain tactual and kinaesthetic sensations usually characteristic of touching the painful tooth and neighbouring parts of our face, and if these sensations were accompanied by seeing my hand touch, and move about on, the edge of my table, we should feel doubtful whether to call this

Page Break 53

experience an experience of toothache in the table or not. If, on the other hand, the tactual and kinaesthetic sensations described were correlated to the visual experience of seeing my hand touch a tooth and other parts of the face of another person, there is no doubt that I would call this experience "toothache in another person's tooth".

Page 53

I said that the man who contended that it was impossible to feel the other person's pain did not thereby wish to deny that one person could feel pain in another person's body. In fact, he would have said: "I may have toothache in another man's tooth, but not his toothache".

Page 53

Thus the propositions "A has a gold tooth" and "A has toothache" are not used analogously. They differ in their grammar where at first sight they might not seem to differ.

Page 53

As to the use of the word "imagine"-one might say: "Surely there is quite a definite act of imagining the other person to have pain". Of course we don't deny this, or any other statement about facts. But let us see: If we make an image of the other person's pain, do we apply it in the same way in which we apply the image, say, of a black eye, when we imagine the other person having one? Let us again replace imagining, in the ordinary sense, by making a painted image. (This could quite well be *the* way certain beings did their imagining.) Then let a man imagine in this way that A has a black eye. A very important application of this picture will be comparing it with the real eye to see if the picture is correct. When we vividly imagine that someone suffers pain, there often enters in our image what one might call a shadow of a pain felt in the locality corresponding to that in which we say his pain is felt. But the sense in which an image is an image is determined by the way in which it is compared with reality. This we might call the method of projection. Now think of comparing an image of A's toothache with his toothache. How would you compare them? If you say, you compare them 'indirectly' via his bodily behaviour, I answer that this means you *don't* compare them as you compare the picture of his behaviour with his behaviour.

Page 53

Again, when you say, "I grant you that you can't *know* when A has pain, you can only conjecture it", you don't see the difficulty which lies in the different uses of the words "conjecturing" and "knowing". What sort of impossibility were you referring to when you said you *couldn't* know? Weren't you thinking of a case analogous to that when one couldn't know whether the other man had a gold tooth in his mouth because he had his mouth shut? Here what you didn't know you could nevertheless imagine knowing; it made sense to say that you

Page Break 54

saw that tooth although you didn't see it; or rather, it makes sense to say that you don't see his tooth and therefore it also makes sense to say that you do. When on the other hand, you granted me that a man can't *know* whether the other person has pain, you do not wish to say that as a matter of fact people didn't know, but that it made no sense to say they knew (and therefore no sense to say they don't know). If therefore in this case you use the term "conjecture" or "believe", you don't use it as opposed to "know". That is, you did not state that knowing was a goal which you could not reach, and that you have to be contented with conjecturing; rather, there is no goal in this game. Just as when one says "You can't count through the whole series of cardinal numbers", one doesn't state a fact about human frailty but about a convention which we have made. Our statement is not comparable, though always falsely compared, with such a one as "it is impossible for a human being to swim across the Atlantic"; but it *is* analogous to a statement like "there is no goal in an endurance race". And this is one of the things which the person feels dimly who is not satisfied with the explanation that though you can't know... you can conjecture....

Page 54

If we are angry with someone for going out on a cold day with a cold in his head, we sometimes say: "I won't feel your cold". And this can mean: "I don't suffer when you catch a cold". This is a proposition taught by experience. For we could imagine a, so to speak, wireless connection between the two bodies which made one

person feel pain in his head when the other had exposed his to the cold air. One might in this case argue that the pains are mine because they are felt in my head; but suppose I and someone else had a part of our bodies in common, say a hand. Imagine the nerves and tendons of my arm and A's connected to this hand by an operation. Now imagine the hand stung by a wasp. Both of us cry, contort our faces, give the same description of the pain, etc. Now are we to say we have the same pain or different ones? If in such a case you say: "We feel pain in the same place, in the same body, our descriptions tally, but still my pain can't be his", I suppose as a reason you will be inclined to say: "because my pain is my pain and his pain is his pain". And here you are making a grammatical statement about the use of such a phrase as "the same pain". You say that you don't wish to apply the phrase, "he has got my pain" or "we both have the same pain", and instead, perhaps, you will apply such a phrase as "his pain is exactly like mine". (It would be no argument to say that the two couldn't have the same pain

Page Break 55

because one might anaesthetize or kill one of them while the other still felt pain.) Of course, if we exclude the phrase "I have his toothache" from our language, we thereby also exclude "I have (or feel) *my* toothache". Another form of our metaphysical statement is this: "A man's sense data are private to himself". And this way of expressing it is even more misleading because it looks still more like an experiential proposition; the philosopher who says this may well think that he is expressing a kind of scientific truth.

Page 55

We use the phrase "two books have the *same* colour", but we could perfectly well say: "They can't have the *same* colour, because, after all, this book has its own colour, and the other book has its own colour too". This also would be stating a grammatical rule—a rule, incidentally, not in accordance with our ordinary usage. The reason why one should think of these two different usages at all is this: We compare the case of sense data with that of physical bodies, in which case we make a distinction between: "this is the same chair that I saw an hour ago" and "this is not the same chair, but one exactly like the other". Here it makes sense to say, and it is an experiential proposition: "A and B couldn't have seen the same chair, for A was in London and B in Cambridge; they saw two chairs exactly alike". (Here it will be useful if you consider the different criteria for what we call the "identity of these objects". How do we apply the statements: "This is the same day...", "This is the same word...", "This is the same occasion...", etc.?)

Page 55

What we did in these discussions was what we always do when we meet the word "can" in a metaphysical proposition. We show that this proposition hides a grammatical rule. That is to say, we destroy the outward similarity between a metaphysical proposition and an experiential one, and we try to find the form of expression which fulfils a certain craving of the metaphysician which our ordinary language does not fulfil and which, as long as it isn't fulfilled, produces the metaphysical puzzlement. Again, when in a metaphysical sense I say "I *must* always know when I have pain", this simply makes the word "know" redundant; and instead of "I know that I have pain", I can simply say "I have pain". The matter is different, of course, if we give the phrase "unconscious pain" sense by fixing experiential criteria for the case in which a man has pain and doesn't know it, and if then we say (rightly or wrongly) that as a matter of fact nobody has ever had pains which he didn't know of.

Page 55

When we say "I can't feel his pain", the idea of an insurmountable

Page Break 56

barrier suggests itself to us. Let us think straight away of a similar case: "The colours green and blue can't be in the same place simultaneously". Here the picture of physical impossibility which suggests itself is, perhaps, not that of a barrier; rather we feel that the two colours are in each other's way. What is the origin of this idea?—We say three people can't sit side by side on this bench; they have no room. Now the case of the colours is not analogous to this; but it is somewhat analogous to saying: "3 × 18 inches won't go into 3 feet". This is a grammatical rule and states a logical impossibility. The proposition "three men can't sit side by side on a bench a yard long" states a physical impossibility; and this example shows clearly why the two impossibilities are confused. (Compare the proposition "He is 6 inches taller than I" with "6 foot is 6 inches longer than 5 foot 6". These propositions are of utterly different kinds, but look exactly alike.) The reason why in these cases the idea of physical impossibility suggests itself to us is that on the one hand we decide against using a particular form of expression, on the other hand we are strongly tempted to use it, since (a) it sounds English, or German, etc., all right, and (b) there are closely similar forms of expression used in other departments of our language. We have decided against using the phrase "They are in the same place"; on the other hand this phrase strongly recommends itself to us through the analogy with other phrases, so that, in a sense, we have to turn this form of expression out by force. And this is why we seem to ourselves to be rejecting a universally false proposition. We make a picture like that of the two colours being in each other's way, or

that of a barrier which doesn't allow one person to come closer to another's experience than to the point of observing his behaviour; but on looking closer we find that we can't apply the picture which we have made.

Page 56

Our wavering between logical and physical impossibility makes us make such statements as this: "If what I feel is always *my* pain only, what can the supposition mean that someone else has pain?" The thing to do in such cases is always to look how the words in question *are actually used in our language*. We are in all such cases thinking of a use different from that which our ordinary language makes of the words. Of a use, on the other hand, which just then for some reason strongly recommends itself to us. When something seems queer about the grammar of our words, it is because we are alternately tempted to use a word in several different ways. And it is particularly difficult to discover that an assertion which the metaphysician makes expresses

Page Break 57

discontentment with our grammar when the words of this assertion can also be used to state a fact of experience. Thus when he says "only my pain is real pain", this sentence might mean that the other people are only pretending. And when he says "this tree doesn't exist when nobody sees it", this might mean: "this tree vanishes when we turn our backs to it". The man who says "only my pain is real", doesn't mean to say that he has found out by the common criteria--the criteria, i.e., which give our words their common meanings--that the others who said they had pains were cheating. But what he rebels against is the use of *this* expression in connection with *these* criteria. That is, he objects to using this word in the particular way in which it is commonly used. On the other hand, he is not aware that he is objecting to a convention. He sees a way of dividing the country different from the one used on the ordinary map. He feels tempted, say, to use the name "Devonshire" not for the county with its conventional boundary, but for a region differently bounded. He could express this by saying: "Isn't it absurd to make *this* a county, to draw the boundaries *here*?" But what he says is: "The *real* Devonshire is this". We could answer: "What you want is only a new notation, and by a new notation no facts of geography are changed". It is true, however, that we may be irresistibly attracted or repelled by a notation. (We easily forget how much a notation, a form of expression, may mean to us, and that changing it isn't always as easy as it often is in mathematics or in the sciences. A change of clothes or of names may mean very little and it may mean a great deal.)

Page 57

I shall try to elucidate the problem discussed by realists, idealists, and solipsists by showing you a problem closely related to it. It is this: "Can we have unconscious thoughts, unconscious feelings, etc.?" The idea of there being unconscious thoughts has revolted many people. Others again have said that these were wrong in supposing that there could only be conscious thoughts, and that psychoanalysis had discovered unconscious ones. The objectors to unconscious thought did not see that they were not objecting to the newly discovered psychological reactions, but to the way in which they were described. The psychoanalysts on the other hand were misled by their own way of expression into thinking that they had done more than discover new psychological reactions; that they had, in a sense, discovered conscious thoughts which were unconscious. The first could have stated their objection by saying "We don't wish to use the phrase 'unconscious thoughts'; we wish to reserve the word '*thought*' for

Page Break 58

what you call 'conscious thoughts'". They state their case wrongly when they say: "There can only be conscious thoughts and no unconscious ones". For if they don't wish to talk of "unconscious thought" they should not use the phrase "conscious thought", either.

Page 58

But is it not right to say that in any case the person who talks both of conscious and unconscious thoughts thereby uses the word "thoughts" in two different ways?--Do we use a hammer in two different ways when we hit a nail with it and, on the other hand, drive a peg into a hole? And do we use it in two different ways or in the same way when we drive this peg into this hole and, on the other hand, another peg into another hole? Or should we only call it different uses when in one case we drive something into something and in the other, say, we smash something? Or is this all using the hammer in one way and is it to be called a different way only when we use the hammer as a paper weight?--In which cases are we to say that a word is used in two different ways and in which that it is used in one way? To say that a word is used in two (or more) different ways does in itself not yet give us any idea about its use. It only specifies a way of looking at this usage by providing a schema for its description with two (or more) subdivisions. It is all right to say: "I do *two* things with this hammer: I drive a nail into this board and one into that board". But I could also have said: "I am doing only one thing with this hammer; I am driving a nail into this board and one into that board". There can be two kinds of discussions as to whether a word is used in one way or in two ways: (a) Two people may discuss whether the English word "cleave" is only used for chopping up something or also for joining things together. This is a discussion about the facts of a certain actual usage. (b) They

may discuss whether the word "altus", standing for both "deep" and "high", is *thereby* used in two different ways. This question is analogous to the question whether the word "thought" is used in two ways or in one when we talk of conscious and unconscious thought. The man who says "surely, these are two different usages" has already decided to use a two-way schema, and what he said expressed this decision.

Page 58

Now when the solipsist says that only his own experiences are real, it is no use answering him: "Why do you tell us this if you don't believe that we really hear it?" Or anyhow, if we give him this answer, we mustn't believe that we have answered his difficulty. There is no common sense answer to a philosophical problem. One can defend common sense against the attacks of philosophers only by solving

Page Break 59

their puzzles, i.e., by curing them of the temptation to attack common sense; not by restating the views of common sense. A philosopher is not a man out of his senses, a man who doesn't see what everybody sees; nor on the other hand is his disagreement with common sense that of the scientist disagreeing with the coarse views of the man in the street. That is, his disagreement is not founded on a more subtle knowledge of fact. We therefore have to look round for the *source* of his puzzlement. And we find that there is puzzlement and mental discomfort, not only when our curiosity about certain facts is not satisfied or when we can't find a law of nature fitting in with all our experience, but also when a notation dissatisfies us--perhaps because of various associations which it calls up. Our ordinary language, which of all possible notations is the one which pervades all our life, holds our mind rigidly in one position, as it were, and in this position sometimes it feels cramped, having a desire for other positions as well. Thus we sometimes wish for a notation which stresses a difference more strongly, makes it more obvious, than ordinary language does, or one which in a particular case uses more closely similar forms of expression than our ordinary language. Our mental cramp is loosened when we are shown the notations which fulfil these needs. These needs can be of the greatest variety.

Page 59

Now the man whom we call a solipsist and who says that only his own experiences are real, does not thereby disagree with us about any practical question of fact, he does not say that we are simulating when we complain of pains, he pities us as much as anyone else, and at the same time he wishes to restrict the use of the epithet "real" to what we should call his experiences; and perhaps he doesn't want to call our experiences "experiences" at all (again without disagreeing with us about any question of fact). For he would say that it was *inconceivable* that experiences other than his own were real. He ought therefore to use a notation in which such a phrase as "A has real toothache" (where A is not he) is meaningless, a notation whose rules exclude this phrase as the rules of chess exclude a pawn's making a knight's move. The solipsist's suggestion comes to using such a phrase as "there is real toothache" instead of "Smith (the solipsist) has toothache". And why shouldn't we grant him this notation? I needn't say that in order to avoid confusion he had in this case better not use the word "real" as opposed to "simulated" at all; which just means that we shall have to provide for the distinction "real"/"simulated" in some other way. The solipsist who says

Page Break 60

"only I feel real pain", "only I really see (or hear)" is not stating an opinion; and that's why he is so sure of what he says. He is irresistibly tempted to use a certain form of expression; but we must yet find *why* he is.

Page 60

The phrase "only I really see" is closely connected with the idea expressed in the assertion "we never know what the other man really sees when he looks at a thing" or this, "we can never know whether he calls the same thing 'blue' which we call 'blue' ". In fact we might argue: "I can never know what he sees or that he sees at all, for all I have is signs of various sorts which he gives me; therefore it is an unnecessary hypothesis altogether to say that he sees; what seeing is I only know from seeing myself; I have only learnt the word 'seeing' to mean what *I* do". Of course this is just not true, for I have definitely learned a different and much more complicated use of the word "to see" than I here profess. Let us make clear the tendency which guided me when I did so, by an example from a slightly different sphere: Consider this argument: "How can we wish that this paper were red if it isn't red? Doesn't this mean that I wish that which doesn't exist at all? Therefore my wish can only contain something *similar* to the paper's being red. Oughtn't we therefore to use a different word instead of 'red' when we talk of wishing that something were red? The imagery of the wish surely shows us something less definite, something hazier, than the reality of the paper being red. I should therefore say, instead of 'I wish this paper were red', something like 'I wish a pale red for this paper' ". But if in the usual way of speaking he had said, "I wish a pale red for this paper," we should, in order to fulfil his wish, have painted it a pale red--and this wasn't what he wished. On the other hand there is no objection to adopting the form of expression which he suggests as long as we know that he uses the phrase "I wish a pale *x* for this paper", always to mean what ordinarily we express by "I wish this paper had the colour *x*".

What he said really recommended his notation, in the sense in which a notation can be recommended. But he did not tell us a new truth and did not show us that what we said before was false. (All this connects our present problem with the problem of negation. I will only give you a hint, by saying that a notation would be possible in which, to put it roughly, a quality had always two names, one for the case when something is said to have it, the other for the case when something is said not to have it. The negation of "This paper is red" could then be, say, "This paper is not rode". Such a notation would actually fulfil some of the

Page Break 61

wishes which are denied us by our ordinary language and which sometimes produce a cramp of philosophical puzzlement about the idea of negation.)

Page 61

The difficulty which we express by saying "I can't know what he sees when he (truthfully) says that he sees a blue patch" arises from the idea that "knowing what he sees" means: "seeing that which he also sees"; not, however, in the sense in which we do so when we both have the same object before our eyes: but in the sense in which the object seen would be an object, say, in his head, or in *him*. The idea is that the same object may be before his eyes and mine, but that I can't stick my head into his (or my mind into his, which comes to the same) so that the *real* and *immediate* object of his vision becomes the real and immediate object of my vision too. By "I don't know what he sees" we really mean "I don't know what he looks at", where 'what he looks at' is hidden and he can't show it to me; it is *before his mind's eye*. Therefore, in order to get rid of this puzzle, examine the grammatical difference between the statements "I don't know what he sees" and "I don't know what he looks at", as they are actually used in our language.

Page 61

Sometimes the most satisfying expression of our solipsism seems to be this: "When anything is seen (really *seen*), it is always I who see it".

Page 61

What should strike us about this expression is the phrase "always I". Always *who?*--For, queer enough, I don't mean: "always L. W." This leads us to considering the criteria for the identity of a person. Under what circumstances do we say: "This is the same person whom I saw an hour ago"? Our actual use of the phrase "the same person" and of the name of a person is based on the fact that many characteristics which we use as the criteria for identity coincide in the vast majority of cases. I am as a rule recognized by the appearance of my body. My body changes its appearance only gradually and comparatively little, and likewise my voice, characteristic habits, etc. only change slowly and within a narrow range. We are inclined to use personal names in the way we do, only as a consequence of these facts. This can best be seen by imagining unreal cases which show us what different 'geometries' we would be inclined to use if facts were different. Imagine, e.g., that all human bodies which exist looked alike, that on the other hand, different sets of characteristics seemed, as it were, to change their habitation among these bodies. Such a set of characteristics might be, say, mildness, together with a high pitched voice, and slow movements, or a choleric temperament, a deep voice, and jerky movements, and such like. Under such circumstances, although

Page Break 62

it would be possible to give the bodies names, we should perhaps be as little inclined to do so as we are to give names to the chairs of our dining-room set. On the other hand, it might be useful to give names to the sets of characteristics, and the use of these names would now *roughly* correspond to the personal names in our present language.

Page 62

Or imagine that it were usual for human beings to have two characters, in this way: People's shape, size and characteristics of behaviour periodically undergo a complete change. It is the usual thing for a man to have two such states, and he lapses suddenly from one into the other. It is very likely that in such a society we should be inclined to christen every man with two names, and perhaps to talk of the pair of persons in his body. Now were Dr. Jekyll and Mr. Hyde two persons or were they the same person who merely changed? We can say whichever we like. We are not forced to talk of a double personality.

Page 62

There are many uses of the word "personality" which we may feel inclined to adopt, all more or less akin. The same applies when we define the identity of a person by means of his memories. Imagine a man whose memories on the even days of his life comprise the events of all these days, skipping entirely what happened on the odd days. On the other hand, he remembers on an odd day what happened on previous odd days, but his memory then skips the even days without a feeling of discontinuity. If we like we can also assume that he has alternating

appearances and characteristics on odd and even days. Are we bound to say that here two persons are inhabiting the same body? That is, is it right to say that there are, and wrong to say that there aren't, or vice versa? Neither. For the ordinary use of the word "person" is what one might call a composite use suitable under the ordinary circumstances. If I assume, as I do, that these circumstances are changed, the application of the term "person" or "personality" has thereby changed; and if I wish to preserve this term and give it a use analogous to its former use, I am at liberty to choose between many uses, that is, between many different kinds of analogy. One might say in such a case that the term "personality" hasn't got one legitimate heir only. (This kind of consideration is of importance in the philosophy of mathematics. Consider the use of the words "proof", "formula", and others. Consider the question: "Why should what we do here be called 'philosophy'? Why should it be regarded as the only legitimate heir of the different activities which had this name in former times?")

Page Break 63

Page 63

Now let us ask ourselves what sort of identity of personality it is we are referring to when we say "when anything is seen, it is always I who see". What is it I want all these cases of seeing to have in common? As an answer I have to confess to myself that it is not my bodily appearance. I don't always see part of my body when I see. And it isn't essential that my body, if seen amongst the things I see, should always look the same. In fact I don't mind how much it changes. And I feel the same way about all the properties of my body, the characteristics of my behaviour, and even about my memories.--When I think about it a little longer I see that what I wished to say was: "Always when anything is seen, something is seen". I.e., that of which I said it continued during all the experiences of seeing was not any particular entity "I", but the experience of seeing itself. This may become clearer if we imagine the man who makes our solipsistic statement to point to his eyes while he says "I". (Perhaps because he wishes to be exact and wants to say expressly which eyes belong to the mouth which says "I" and to the hands pointing to his own body). But what is he pointing to? These particular eyes with the identity of physical objects? (To understand this sentence, you must remember that the grammar of words of which we say that they stand for physical objects is characterized by the way in which we use the phrase "the same so-and-so", or "the identical so-and-so", where "so-and-so" designates the physical object.) We said before that he did not wish to point to a particular physical object at all. The idea that he had made a significant statement arose from a confusion corresponding to the confusion between what we shall call "the geometrical eye" and "the physical eye". I will indicate the use of these terms: If a man tries to obey the order "Point to your eye", he may do many different things, and there are many different criteria which he will accept for having pointed to his eye. If these criteria, as they usually do, coincide, I may use them alternately and in different combinations to show me that I have touched my eye. If they don't coincide, I shall have to distinguish between different senses of the phrase "I touch my eye" or "I move my finger towards my eye". If, e.g., my eyes are shut, I can still have the characteristic kinaesthetic experience in my arm which I should call the kinaesthetic experience of raising my hand to my eye. That I had succeeded in doing so, I shall recognize by the peculiar tactile sensation of touching my eye. But if my eye were behind a glass plate fastened in such a way that it prevented me from exerting a pressure on my eye with my

Page Break 64

finger, there would still be a criterion of muscular sensation which would make me say that now my finger was in front of my eye. As to visual criteria, there are two I can adopt. There is the ordinary experience of seeing my hand rise and come towards my eye, and this experience, of course, is different from seeing two things meet, say, two finger tips. On the other hand, I can use as a criterion for my finger moving towards my eye, what I see when I look into a mirror and see my finger nearing my eye. If that place on my body which, we say, 'sees' is to be determined by moving my finger towards my eye, according to the second criterion, then it is conceivable that I may see with what according to other criteria is the tip of my nose, or places on my forehead; or I might in this way point to a place lying outside my body. If I wish a person to point to his eye (or his eyes) according to the second criterion *alone*, I shall express my wish by saying: "Point to your geometrical eye (or eyes)". The grammar of the word "geometrical eye" stands in the same relation to the grammar of the word "physical eye" as the grammar of the expression "the visual sense datum of a tree" to the grammar of the expression "the physical tree". In either case it confuses everything to say "the one is a *different kind* of object from the other"; for those who say that a sense datum is a different kind of object from a physical object misunderstand the grammar of the word "kind", just as those who say that a number is a different kind of object from a numeral. They think they are making such a statement as "A railway train, a railway station, and a railway car are different kinds of objects", whereas their statement is analogous to "A railway train, a railway accident, and a railway law are different kinds of objects".

Page 64

What tempted me to say "it is always I who see when anything is seen", I could also have yielded to by

saying: "whenever anything is seen, it is *this* which is seen", accompanying the word "this" by a gesture embracing my visual field (but not meaning by "this" the particular objects which I happen to see at the moment). One might say, "I am pointing at the visual field as such, not at anything in it". And this only serves to bring out the senselessness of the former expression.

Page 64

Let us then discard the "always" in our expression. Then I can still express my solipsism by saying, "Only what *I* see (or: see now) is really seen". And here I am tempted to say: "Although by the word 'I' I don't mean L. W., it will do if the others understand 'I' to mean L. W., if just now I am in fact L. W." I could also express my claim by

Page Break 65

saying: "I am the vessel of life"; but mark, it is essential that everyone to whom I say this should be unable to understand me. It is essential that the other should not be able to understand 'what *I* really *mean*', though in practice he might do what I wish by conceding to me an exceptional position in his notation. But I wish it to be *logically* impossible that he should understand me, that is to say, it should be meaningless, not false, to say that he understands me. Thus my expression is one of the many which is used on various occasions by philosophers and supposed to convey something to the person who says it, though essentially incapable of conveying anything to anyone else. Now if for an expression to convey a meaning means to be accompanied by or to produce certain experiences, our expression may have all sorts of meanings, and I don't wish to say anything about them. But we are, as a matter of fact, misled into thinking that our expression has a meaning in the sense in which a non-metaphysical expression has; for we wrongly compare our case with one in which the other person can't understand what we say because he lacks a certain information. (This remark can only become dear if we understand the connection between grammar and sense and nonsense.)

Page 65

The meaning of a phrase for us is characterized by the use we make of it. The meaning is not a mental accompaniment to the expression. Therefore the phrase "I think I mean something by it", or "I'm sure I mean something by it", which we so often hear in philosophical discussions to justify the use of an expression is for us no justification at all. We ask: "*What* do you mean?", i.e., "How do you use this expression?" If someone taught me the word "bench" and said that he sometimes or always put a stroke over it thus: "**bench**", and that this meant something to him, I should say: "I don't know what sort of idea you associate with this stroke, but it doesn't interest me unless you show me that there is a use for the stroke in the kind of calculus in which you wish to use the word 'bench'".--I want to play chess, and a man gives the white king a paper crown, leaving the use of the piece unaltered, but telling me that the crown has a meaning to him in the game, which he can't express by rules. I say: "as long as it doesn't alter the use of the piece, it hasn't what I call a meaning".

Page 65

One sometimes hears that such a phrase as "This is here", when while I say it I point to a part of my visual field, has a kind of primitive meaning to me, although it can't impart information to anybody else.

Page 65

When I say "Only this is seen", I forget that a sentence may come ever so natural to us without having any use in our calculus of language.

Page Break 66

Think of the law of identity, " $a = a$ ", and of how we sometimes try hard to get hold of its sense, to visualize it, by looking at an object and repeating to ourselves such a sentence as "This tree is the same thing as this tree". The gestures and images by which I apparently give this sentence sense are very similar to those which I use in the case of "Only *this* is really seen". (To get clear about philosophical problems, it is useful to become conscious of the apparently unimportant details of the particular situation in which we are inclined to make a certain metaphysical assertion. Thus we may be tempted to say "Only this is really seen" when we stare at unchanging surroundings, whereas we may not at all be tempted to say this when we look about us while walking.)

Page 66

There is, as we have said, no objection to adopting a symbolism in which a certain person always or temporarily holds an exceptional place. And therefore, if I utter the sentence "Only I really see", it is conceivable that my fellow creatures thereupon will arrange their notation so as to fall in with me by saying "so-and-so is really seen" instead of "L. W. sees so-and-so", etc., etc. What, however, is wrong, is to think that I can *justify* this choice of notation. When I said, from my heart, that only I see, I was also inclined to say that by "I" I didn't really mean L. W., although for the benefit of my fellow men I might say "It is now L. W. who really sees" though this is not what I really mean. I could almost say that by "I" I mean something which just now inhabits L. W., something which the others can't see. (I meant my mind, but could only point to it via my body.) There is nothing wrong in suggesting

that the others should give me an exceptional place in their notation; but the justification which I wish to give for it: that this body is now the seat of that which really lives--is senseless. For admittedly this is not to state anything which in the ordinary sense is a matter of experience. (And don't think that it is an experiential proposition which only I can know because only I am in the position to have the particular experience.) Now the idea that the real I lives in my body is connected with the peculiar grammar of the word "I", and the misunderstandings this grammar is liable to give rise to. There are two different cases in the use of the word "I" (or "my") which I might call "the use as object" and "the use as subject". Examples of the first kind of use are these: "My arm is broken", "I have grown six inches", "I have a bump on my forehead", "The wind blows my hair about". Examples of the second kind are: "I see so-and-so", "I hear so-and-so", "I try to lift my arm", "I think it will

Page Break 67

rain", "I have toothache". One can point to the difference between these two categories by saying: The cases of the first category involve the recognition of a particular person, and there is in these cases the possibility of an error, or as I should rather put it: The possibility of an error has been provided for. The possibility of failing to score has been provided for in a pin game. On the other hand, it is not one of the hazards of the game that the balls should fail to come up if I have put a penny in the slot. It is possible that, say in an accident, I should feel a pain in my arm, see a broken arm at my side, and think it is mine, when really it is my neighbour's. And I could, looking into a mirror, mistake a bump on his forehead for one on mine. On the other hand, there is no question of recognizing a person when I say I have toothache. To ask "are you sure that it's *you* who have pains?" would be nonsensical. Now, when in this case no error is possible, it is because the move which we might be inclined to think of as an error, a 'bad move', is no move of the game at all. (We distinguish in chess between good and bad moves, and we call it a mistake if we expose the queen to a bishop. But it is no mistake to promote a pawn to a king.) And now this way of stating our idea suggests itself: that it is as impossible that in making the statement "I have toothache" I should have mistaken another person for myself, as it is to moan with pain by mistake, having mistaken someone else for me. To say, "I have pain" is no more a statement *about* a particular person than moaning is. "But surely the word 'I' in the mouth of a man refers to the man who says it; it points to himself; and very often a man who says it actually points to himself with his finger". But it was quite superfluous to point to himself. He might just as well only have raised his hand. It would be wrong to say that when someone points to the sun with his hand, he is pointing both to the sun and himself because it is *he* who points; on the other hand, he may by pointing attract attention both to the sun and to himself.

Page 67

The word "I" does not mean the same as "L. W." even if I am L. W., nor does it mean the same as the expression "the person who is now speaking". But that doesn't mean: that "L. W." and "I" mean different things. All it means is that these words are different instruments in our language.

Page 67

Think of words as instruments characterized by their use, and then think of the use of a hammer, the use of a chisel, the use of a square, of a glue pot, and of the glue. (Also, all that we say here can be understood only if one understands that a great variety of games is played

Page Break 68

with the sentences of our language: Giving and obeying orders; asking questions and answering them; describing an event; telling a fictitious story; telling a joke; describing an immediate experience; making conjectures about events in the physical world; making scientific hypotheses and theories; greeting someone, etc., etc.) The mouth which says "I" or the hand which is raised to indicate that it is I who wish to speak, or I who have toothache, does not thereby point to anything. If, on the other hand, I wish to indicate the *place* of my pain, I point. And here again remember the difference between pointing to the painful spot without being led by the eye and on the other hand pointing to a scar on my body after looking for it. ("That's where I was vaccinated".)--The man who cries out with pain, or says that he has pain, *doesn't choose the mouth which says it*.

Page 68

All this comes to saying that the person of whom we say "he has pain" is, by the rules of the game, the person who cries, contorts his face, etc. The place of the pain--as we have said--may be in another person's body. If, in saying "I", I point to my own body, I model the use of the word "I" on that of the demonstrative "this person" or "he". (This way of making the two expressions similar is somewhat analogous to that which one sometimes adopts in mathematics, say in the proof that the sum of the three angles of a triangle is 180°.

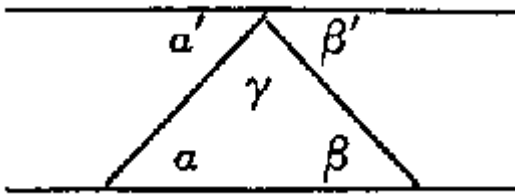

We say " $\alpha = \alpha'$, $\beta = \beta'$, and $\gamma = \gamma$ ". The first two equalities are of an entirely different kind from the third.) In "I have pain", "I" is not a demonstrative pronoun.

Page 68

Compare the two cases: 1. "How do you know that *he* has pains?"--"Because I hear him moan". 2. "How do you know that you have pains?"--"Because I *feel* them". But "I feel them" means the same as "I have them". Therefore this was no explanation at all. That, however, in my answer I am inclined to stress the word "feel" and not the word "I" indicates that by "I" I don't wish to pick out one person (from amongst different persons).

Page 68

The difference between the propositions "I have pain" and "he has pain" is not that of "L. W. has pain" and "Smith has pain". Rather, it corresponds to the difference between moaning and saying that someone moans.--"But surely the word 'I' in 'I have pain' serves to

Page Break 69

distinguish me from other people, because it is by the sign 'I' that I distinguish saying that I have pain from saying that one of the others has". Imagine a language in which, instead of "I found nobody in the room", one said "I found Mr. Nobody in the room". Imagine the philosophical problems which would arise out of such a convention. Some philosophers brought up in this language would probably feel that they didn't like the similarity of the expressions "Mr. Nobody" and "Mr. Smith". When we feel that we wish to abolish the "I" in "I have pain", one may say that we tend to make the verbal expression of pain similar to the expression by moaning.--We are inclined to forget that it is the particular use of a word only which gives the word its meaning. Let us think of our old example for the use of words: Someone is sent to the grocer with a slip of paper with the words "five apples" written on it. The use of the word *in practice* is its meaning. Imagine it were the usual thing that the objects around us carried labels with words on them by means of which our speech referred to the objects. Some of these words would be proper names of the objects, others generic names (like table, chair, etc.), others again, names of colours, names of shapes, etc. That is to say, a label would only have a meaning to us in so far as we made a particular use of it. Now we could easily imagine ourselves to be impressed by merely seeing a label on a thing, and to forget that what makes these labels important is their use. In this way we sometimes believe that we have named something when we make the gesture of pointing and utter words like "This is..." (the formula of the ostensive definition). We say we call something "toothache", and think that the word has received a definite function in the dealings we carry out with language when, under certain circumstances, we have pointed to our cheek and said: "This is toothache". (Our idea is that when we point and the other "only knows what we are pointing to" he knows the use of the word. And here we have in mind the special case when 'what we point to' is, say, a person and "to know that I point to" means to see which of the persons present I point to.)

Page 69

We feel then that in the cases in which "I" is used as subject, we don't use it because we recognize a particular person by his bodily characteristics; and this creates the illusion that we use this word to refer to something bodiless, which, however, has its seat in our body. In fact *this* seems to be the real ego, the one of which it was said, "Cogito, ergo sum".--"Is there then no mind, but only a body?" Answer: The word "mind" has meaning, i.e., it has a use in our

Page Break 70

language; but saying this doesn't yet say what kind of use we make of it.

Page 70

In fact one may say that what in these investigations we were concerned with was the grammar of those words which describe what are called "mental activities": seeing, hearing, feeling, etc. And this comes to the same as saying that we are concerned with the grammar of 'phrases describing sense data'.

Page 70

Philosophers say it as a philosophical opinion or conviction that there are sense data. But to say that I *believe* that there are sense data comes to saying that I believe that an object may appear to be before our eyes even when it isn't. Now when one uses the word "sense datum", one should be clear about the peculiarity of its grammar. For the idea in introducing this expression was to model expressions referring to 'appearance' after expressions referring to

'reality'. It was said, e.g., that if two things *seem* to be equal, there *must* be two somethings which *are* equal. Which of course means nothing else but that we have decided to use such an expression as "the appearances of these two things are equal" synonymously with "these two things seem to be equal". Queerly enough, the introduction of this new phraseology has deluded people into thinking that they had discovered new entities, new elements of the structure of the world, as though to say "I believe that there are sense data" were similar to saying "I believe that matter consists of electrons". When we talk of the equality of appearances or sense data, we introduce a new usage of the word "equal". It is possible that the lengths A and B should appear to us to be equal, that B and C should appear to be equal, but that A and C do not appear to be equal. And in the new notation we shall have to say that though the appearance (sense datum) of A is equal to that of B and the appearance of B equal to that of C, the appearance of A is not equal to the appearance of C; which is all right if you don't mind using "equal" intransitively.

Page 70

Now the danger we are in when we adopt the sense datum notation is to forget the difference between the grammar of a statement about sense data and the grammar of an outwardly similar statement about physical objects. (From this point one might go on talking about the misunderstandings which find their expression in such sentences as: "We can never see an accurate circle", "All our sense data are vague". Also, this leads to the comparison of the grammar of "position", "motion", and "size" in Euclidean and in visual space.)

Page Break 71

There is, e.g., absolute position, absolute motion and size, in visual space.)

Page 71

Now we can make use of such an expression as "pointing to the *appearance* of a body" or "pointing to a visual sense datum". Roughly speaking, this sort of pointing comes to the same as sighting, say, along the barrel of a gun. Thus we may point and say: "This is the direction in which I see my image in the mirror". One can also use such an expression as "the appearance, or sense datum, of my finger points to the sense datum of the tree" and similar ones. From these cases of pointing, however, we must distinguish those of pointing in the direction a sound seems to come from, or of pointing to my forehead with dosed eyes, etc.

Page 71

Now when in the solipsistic way I say "*This* is what's really seen", I point before me and it is essential that I point *visually*. If I pointed sideways or behind me--as it were, to things which I don't see--the pointing would in this case be meaningless to me; it would not be pointing in the sense in which I wish to point. But this means that when I point before me saying "this is what's really seen", although I make the gesture of pointing, I don't point to one thing as opposed to another. This is as when travelling in a car and feeling in a hurry, I instinctively press against something in front of me as though I could push the car from inside.

Page 71

When it makes sense to say "I see this", or "this is seen", pointing to what I see, it also makes *sense* to say "I see this", or "this is seen", pointing to something I *don't* see. When I made my solipsist statement, I pointed, but I robbed the pointing of its sense by inseparably connecting that which points and that to which it points. I constructed a clock with all its wheels, etc., and in the end fastened the dial to the pointer and made it go round with it. And in this way the solipsist's "Only this is really seen" reminds us of a tautology.

Page 71

Of course one of the reasons why we are tempted to make our pseudo-statement is its similarity with the statement "I only see this", or "this is the region which I see", where I point to certain objects around me, as opposed to others, or in a certain direction in physical space (not in visual space), as opposed to other directions in physical space. And if, pointing in this sense, I say "this is what is really seen", one may answer me: "This is what *you*, L. W., see; but there is no objection to adopting a notation in which what we used to call 'things which L. W. sees' is called 'things really seen'". If, however, I believe that by pointing to that which in my grammar has no

Page Break 72

neighbour I can convey something to myself (if not to others), I make a mistake similar to that of thinking that the sentence "I am here" makes sense to me (and, by the way, is always true) under conditions different from those very special conditions under which it does make sense. E.g., when my voice and the direction from which I speak is recognized by another person. Again an important case where you can learn that a word has meaning by the particular use we make of it.--We are like people who think that pieces of wood shaped more or less like chess or draught pieces and standing on a chess board make a game, even if nothing has been said as to how they are to be used.

Page 72

To say "it approaches me" has sense, even when, physically speaking, nothing approaches my body; and in

the same way it makes sense to say, "it is here" or "it has reached me" when nothing has reached my body. And, on the other hand, "I am here" makes sense if my voice is recognized and heard to come from a particular place of common space. In the sentence "it is here" the 'here' was a here in visual space. Roughly speaking, it is the geometrical eye. The sentence "I am here", to make sense, must attract attention to a place in common space. (And there are several ways in which this sentence might be used.) The philosopher who thinks it makes sense to say to himself "I am here" takes the verbal expression from the sentence in which "here" is a place in common space and thinks of "here" as the here in visual space. He therefore really says something like "Here is here".

Page 72

I could, however, try to express my solipsism in a different way: I imagine that I and others draw pictures or write descriptions of what each of us sees. These descriptions are put before me. I point to the one which I have made and say: "Only this is (or was) really seen". That is, I am tempted to say: "Only this description has reality (visual reality) behind it". The others I might call--"blank descriptions". I could also express myself by saying: "*This* description only was derived from reality; only this was compared with reality". Now it has a clear meaning when we say that this picture or description is a projection, say, of this group of objects--the trees I look at--or that it has been derived from these objects. But we must look into the grammar of such a phrase as "this description is derived from my sense datum". What we are talking about is connected with that peculiar temptation to say: "I never know what the other really means by 'brown', or what he really sees when he (truthfully) says that he sees a brown object".--We could propose to one who says this to use

Page Break 73

two different words instead of the one word "brown"; one word *for his particular impression*, the other word with that meaning which other people besides himself can understand as well. If he thinks about this proposal he will see that there is something wrong in his conception of the meaning, function, of the word "brown" and others. He looks for a justification of his description where there is none. (Just as in the case when a man believes that the chain of reasons must be endless. Think of the justification by a general formula for performing mathematical operations; and of the question: Does this formula compel us to make use of it in this particular case as we do?) To say "I derive a description from visual reality" can't mean anything analogous to: "I derive a description from what I see here". I may, e.g., see a chart in which a coloured square is correlated to the word "brown", and also a patch of the same colour elsewhere; and I may say: "This chart shows me that I must use the word 'brown' for the description of this patch". This is how I may derive the word which is needed in my description. But it would be meaningless to say that I derive the word "brown" from the particular colour-impression which I receive.

Page 73

Let us now ask: "Can a human *body* have pain?" One is inclined to say: "How can the body have pain? The body in itself is something dead; a body isn't conscious!" And here again it is as though we looked into the nature of pain and saw that it lies in its nature that a material object can't have it. And it is as though we saw that what has pain must be an entity of a different nature from that of a material object; that, in fact, it must be of a mental nature. But to say that the ego is mental is like saying that the number 3 is of a mental or an immaterial nature, when we recognize that the numeral "3" isn't used as a sign for a physical object.

Page 73

On the other hand we can perfectly well adopt the expression "this body feels pain", and we shall then, just as usual, tell it to go to the doctor, to lie down, and even to remember that when the last time it had pains they were over in a day. "But wouldn't this form of expression at least be an indirect one?"--Is it using an indirect expression when we say "Write '3' for 'x' in this formula" instead of "Substitute 3 for x"? (Or on the other hand, is the first of these two expressions the only direct one, as some philosophers think?) One expression is no more direct than the other. The meaning of the expression depends entirely on how we go on using it. Let's not imagine the meaning as an occult connection the mind makes between

Page Break 74

a word and a thing, and that this connection *contains* the whole usage of a word as the seed might be said to contain the tree.

Page 74

The kernel of our proposition that that which has pains or sees or thinks is of a mental nature is only, that the word "I" in "I have pains" does not denote a particular body, for we can't substitute for "I" a description of a body.

Page Break 75

THE BROWN BOOK

Page 75

THE BROWN BOOK

I

AUGUSTINE, in describing his learning of language, says that he was taught to speak by learning the names of things. It is clear that whoever says this has in mind the way in which a child learns such words as "man", "sugar", "table", etc. He does not primarily think of such words as "today", "not", "but", "perhaps".

Suppose a man described a game of chess, without mentioning the existence and operations of the pawns. His description of the game as a natural phenomenon will be incomplete. On the other hand we may say that he has completely described a simpler game. In this sense we can say that Augustine's description of learning the language was correct for a simpler language than ours. Imagine this language:--

1). Its function is the communication between a builder A and his man B. B has to reach A building stones. There are cubes, bricks, slabs, beams, columns. The language consists of the words "cube", "brick", "slab", "column". A calls out one of these words, upon which B brings a stone of a certain shape. Let us imagine a society in which this is the only system of language. The child learns this language from the grown-ups by being trained to its use. I am using the word "trained" in a way strictly analogous to that in which we talk of an animal being trained to do certain things. It is done by means of example, reward, punishment, and suchlike. Part of this training is that we point to a building stone, direct the attention of the child towards it, and pronounce a word. I will call this procedure *demonstrative* teaching of words. In the actual use of this language, one man calls out the words as orders, the other acts according to them. But learning and teaching this language will contain this procedure: The child just 'names' things, that is, he pronounces the words of the language when the teacher points to the things. In fact, there will be a still simpler exercise: The child repeats words which the teacher pronounces.

(Note. Objection: The word "brick" in language 1) has not the meaning which it has in *our* language.--This is true if it means that

in our language there are usages of the word "brick" different from our usages of this word in language 1). But don't we sometimes use the word "brick!" in just this way? Or should we say that when we use it, it is an elliptical sentence, a shorthand for "Bring me a brick"? Is it right to say that if *we* say "brick!" we *mean* "Bring me a brick"? Why should I translate the expression "brick!" into the expression "Bring me a brick"? And if they are synonymous, why shouldn't I say: If he says "brick!" he means "brick!"...? Or: Why shouldn't he be able to mean just "brick!" if he is able to mean "Bring me a brick", unless you wish to assert that while he says aloud "brick!" he as a matter of fact always says in his mind, to himself, "Bring me a brick"? But what reason could we have to assert this? Suppose someone asked: If a man gives the order, "Bring me a brick", must he mean it as four words, or can't he mean it as one composite word synonymous with the one word "brick!"? One is tempted to answer: He *means* all four words if in his language he uses that sentence in contrast with other sentences in which these words are used, such as, for instance, "Take these two bricks away". But what if I asked "But how is his sentence contrasted with these others? Must he have thought them simultaneously, or shortly before or after, or is it sufficient that he should have one time learnt them, etc.?" When we have asked ourselves this question, it appears that it is irrelevant which of these alternatives is the case. And we are inclined to say that all that is really relevant is that these contrasts should exist in the system of language which he is using, and that they need not in any sense be present in his mind when he utters his sentence. Now compare this conclusion with our original question. When we asked it, we seemed to ask a question about the state of mind of the man who says the sentence, whereas the idea of meaning which we arrived at in the end was not that of a state of mind. We think of the meaning of signs sometimes as states of mind of the man using them, sometimes as the role which these signs are playing in a system of language. The connection between these two ideas is that the mental experiences which accompany the use of a sign undoubtedly are caused by our usage of the sign in a particular system of language. William James speaks of specific feelings accompanying the use of such words as "and", "if", "or". And there is no doubt that at least certain gestures are often connected with such words, as a collecting gesture with "and", and a dismissing gesture with "not". And there obviously are visual and muscular sensations connected with these gestures. On the other hand it is clear enough that these sensations do not

accompany every

Page Break 79

use of the word "not" and "and". If in some language the word "but" meant what "not" means in English, it is clear that we should not compare the meanings of these two words by comparing the sensations which they produce. Ask yourself what means we have of finding out the feelings which they produce in different people and on different occasions. Ask yourself: "When I said, 'Give me an apple *and* a pear, *and* leave the room', had I the same feeling when I pronounced the two words 'and'?" But we do not deny that the people who use the word "but" as "not" is used in English will, broadly speaking, have similar sensations accompanying the word "but" to those the English have when they use "not". And the word "but" in the two languages will on the whole be accompanied by different sets of experiences.)

Page 79

2). Let us now look at an extension of language 1). The builder's man knows by heart the series of words from one to ten. On being given the order, "Five slabs!", he goes to where the slabs are kept, says the words from one to five, takes up a slab for each word, and carries them to the builder. Here both the parties use the language by speaking the words. Learning the numerals by heart will be one of the essential features of learning this language. The use of the numerals will again be taught demonstratively. But now the same word, e.g., "three", will be taught by pointing either to slabs, or to bricks, or to columns, etc. And on the other hand, different numerals will be taught by pointing to groups of stones of the same shape.

Page 79

(Remark: We stressed the importance of learning the series of numerals by heart because there was no feature comparable to this in the learning of language 1). And this shows us that by introducing numerals we have introduced an entirely different *kind* of instrument into our language. The difference of kind is much more obvious when we contemplate such a simple example than when we look at our ordinary language with innumerable kinds of words all looking more or less alike when they stand in the dictionary.--

Page 79

What have the demonstrative explanations of the numerals in common with those of the words "slab", "column", etc., except a gesture and pronouncing the words? The way such a gesture is used in the two cases is different. This difference is blurred if one says, "In one case we point to a shape, in the other we point to a number". The difference becomes obvious and clear only when we contemplate a

Page Break 80

complete example (i.e., the example of a language completely worked out in detail.)

Page 80

3). Let us introduce a new instrument of communication,-a proper name. This is given to a particular object (a particular building stone) by pointing to it and pronouncing the name. If A calls the name, B brings the object. The demonstrative teaching of a proper name is different again from the demonstrative teaching in the cases 1) and 2).

Page 80

(Remark: This difference does not lie, however, in the act of pointing and pronouncing the word or in any mental act (meaning?) accompanying it, but in the role which the demonstration (pointing and pronouncing) plays in the whole training and in the use which is made of it in the practice of communication by means of this language. One might think that the difference could be described by saying that in the different cases we point to different kinds of objects. But suppose I point with my hand to a blue jersey. How does pointing to its colour differ from pointing to its shape?--We are inclined to say the difference is that we *mean* something different in the two cases. And 'meaning' here is to be some sort of process taking place while we point. What particularly tempts us to this view is that a man on being asked whether he pointed to the colour or the shape is, at least in most cases, able to answer this and to be certain that his answer is correct. If on the other hand, we look for two such characteristic mental acts as meaning the colour and meaning the shape, etc., we aren't able to find any, or at least none which must always accompany pointing to colour, pointing to shape, respectively. We have only a *rough* idea of what it means to concentrate one's attention on the colour as opposed to the shape, or vice versa. The difference, one might say, does not lie in the act of demonstration, but rather in the surrounding of that act in the use of the language.)

Page 80

4). On being ordered, "This slab!", B brings the slab to which A points. On being ordered, "Slab, there!", he carries a slab to the place indicated. Is the word "there" taught demonstratively? Yes and no! When a person is trained in the use of the word "there", the teacher will in training him make the pointing gesture and pronounce the word "there". But should we say that thereby he gives a place the name "there"? Remember that the pointing gesture

in this case is part of the practice of communication itself.

Page 80

(Remark: It has been suggested that such words as "there", "here", "now", "this" are the '*real proper names*' as opposed to what in ordinary

Page Break 81

life we call proper names, and, in the view I am referring to, can only be called so crudely. There is a widespread tendency to regard what in ordinary life is called a proper name only as a rough approximation of what ideally could be called so. Compare Russell's idea of the 'individual'. He talks of individuals as the ultimate constituents of reality, but says that it is difficult to say which things are individuals. The idea is that further analysis has to reveal this. We, on the other hand, introduced the idea of a proper name in a language in which it was applied to what in ordinary life we call "objects", "things" ("building stones").

Page 81

---"What does the word 'exactness' mean? Is it real exactness if you are supposed to come to tea at 4.30 and come when a good clock strikes 4.30? Or would it only be exactness if you began to open the door at the moment the clock began to strike? But how is this moment to be defined and how is 'beginning to open the door' to be defined? Would it be correct to say, 'It is difficult to say what real exactness is, for all we know is only rough approximations?'"

Page 81

5). Questions and answers: A asks, "How many slabs?" B counts them and answers with the numeral.

Page 81

Systems of communication as for instance 1), 2), 3), 4), 5) we shall call "language games". They are more or less akin to what in ordinary language we call games. Children are taught their native language by means of such games, and here they even have the entertaining character of games. We are not, however, regarding the language games which we describe as incomplete parts of a language, but as languages complete in themselves, as complete systems of human communication. To keep this point of view in mind, it very often is useful to imagine such a simple language to be the entire system of communication of a tribe in a primitive state of society. Think of primitive arithmetics of such tribes.

Page 81

When the boy or grown-up learns what one might call special technical languages, e.g., the use of charts and diagrams, descriptive geometry, chemical symbolism, etc., he learns more language games. (Remark: The picture we have of the language of the grown-up is that of a nebulous mass of language, his mother tongue, surrounded by discrete and more or less clear-cut language games, the technical languages.)

Page 81

6). Asking for the name: we introduce new forms of building stones. B points to one of them and asks, "What is this?"; A answers,

Page Break 82

"This is a...". Later on A calls out this new word, say "arch", and B brings the stone. The words, "This is..." together with the pointing gesture we shall call ostensive explanation or ostensive definition. In case 6) a generic name was explained, in actual fact, as the name of a shape. But we can ask analogously for the proper name of a particular object, for the name of a colour, of a numeral, of a direction.

Page 82

(Remark: Our use of expressions like "names of numbers", "names of colours", "names of materials", "names of nations" may spring from two different sources. One is that we might imagine the functions of proper names, numerals, words for colours, etc., to be much more alike than they actually are. If we do so we are tempted to think that the function of every word is more or less like the function of a proper name of a person, or such generic names as "table", "chair", "door", etc. The second source is this, that if we see how fundamentally different the functions of such words as "table", "chair", etc., are from those of proper names, and how different from either the functions of, say, the names of colours, we see no reason why we shouldn't speak of names of numbers or names of directions either, not by way of saying some such thing as "numbers and directions are just different forms of objects", but rather by way of stressing the analogy which lies in the lack of analogy between the functions of the words "chair" and "Jack" on the one hand, and "east" and "Jack" on the other hand.)

Page 82

7). B has a table in which written signs are placed opposite to pictures of objects (say, a table, a chair, a tea-cup, etc.). A writes one of the signs, B looks for it in the table, looks or points with his finger from the written sign to the picture opposite, and fetches the object which the picture represents.

Let us now look at the different kinds of signs which we have introduced. First let us distinguish between sentences and words. A sentence†1 I will call every complete sign in a language game, its constituent signs are words. (This is merely a rough and general remark about the way I will use the words "proposition"†1 and "word".) A proposition may consist of only one word. In 1) the signs "brick!", "column!" are the sentences. In 2) a sentence consists of two words. According to the role which propositions play in a language game, we distinguish between orders, questions, explanations, descriptions, and so on.

8). If in a language game similar to 1) A calls out an order: "slab, column, brick!" which is obeyed by B by bringing a slab, a column and a brick, we might here talk of three propositions, or of one only. If, on the other hand,

9). the order of words shows B the order in which to bring the building stones, we shall say that A calls out a proposition consisting of three words. If the command in this case took the form, "Slab, then column, then brick!" we should say that it consisted of four words (not of five). Amongst the words we see groups of words with similar functions. We can easily see a similarity in the use of the words "one," "two", "three", etc. and again one in the use of "slab", "column" and "brick", etc., and thus we distinguish parts of speech. In 8) all the words of the proposition belonged to the same part of speech.

10). The order in which B had to bring the stones in 9) could have been indicated by the use of the ordinals thus: "Second, column; first, slab; third, brick!". Here we have a case in which what was the function of the order of words in one language game is the function of particular words in another.

Reflections such as the preceding will show us the infinite variety of the functions of words in propositions, and it is curious to compare what we see in our examples with the simple and rigid rules which logicians give for the construction of propositions. If we group words together according to the similarity of their functions, thus distinguishing parts of speech, it is easy to see that many different ways of classification can be adopted. We could indeed easily imagine a reason for not classing the word "one" together with "two", "three", etc., as follows:

11). Consider this variation of our language game 2). Instead of calling out, "One slab!", "One cube!", etc., A just calls "Slab!", "Cube!", etc., the use of the other numerals being as described in 2). Suppose that a man accustomed to this form 11) of communication was introduced to the use of the word "one" as described in 2). We can easily imagine that he would refuse to classify "one" with the numerals "2" "3" etc.

(Remark: Think of the reasons for and against classifying 'o' with the other cardinals. "Are black and white colours?" In which cases would you be inclined to say so and which not?--Words can in

many ways be compared to chess men. Think of the several ways of distinguishing different kinds of pieces in the game of chess (e.g., pawns and 'officers').

Remember the phrase, "two or more".)

It is natural for us to call gestures, as those employed in 4), or pictures as in 7), elements or instruments of language. (We talk sometimes of a language of gestures.) The pictures in 7) and other instruments of language which have a similar function I shall call patterns. (This explanation, as others which we have given, is vague, and meant to be vague.) We may say that words and patterns have different kinds of functions. When we make use of a pattern we compare something with it, e.g., a chair with the picture of a chair. We did not compare a slab with the word "slab". In introducing the distinction, 'word/pattern', the idea was not to set up a final logical duality. We have only singled out two characteristic kinds of instruments from the variety of instruments in our language. We shall call "one", "two", "three", etc., words. If instead of these signs we used "--", "-- --", "-- -- --", "-- -- -- --", we might call these patterns. Suppose in a language the numerals were "one", "one one", "one one one", etc., should we call "one" a word or a pattern? The same element may in one place be used as word and in another as pattern. A circle might be the name for an ellipse, or on the other hand a pattern with which the ellipse is to be compared by a particular method of projection. Consider also these two systems of expression:

12). A gives B an order consisting of two written symbols, the first an irregularly shaped patch of a certain colour, say green, the second the drawn outline of a geometrical figure, say a circle. B brings an object of this outline and that colour, say a circular green object.

13). A gives B an order consisting of one symbol, a geometrical figure painted a particular colour, say a green circle. B brings him a green circular object. In 12) patterns correspond to our names of colours and other patterns to our names of shape. The symbols in 13) cannot be regarded as combinations of two such elements. A word in inverted commas can be called a pattern. Thus in the sentence "He said 'Go to hell'", "Go to hell" is a pattern of what he said. Compare these cases: a) Someone says "I whistled..." (whistling a tune);



b) Someone writes, "I whistled

". An onomatopoeic

word like "rustling" may be called a pattern. We call a very great variety of processes "comparing an object with a pattern". We comprise many kinds of symbols under the name "pattern". In 7) B compares a picture in the table with the objects he has before him. But what does comparing a picture with the object consist in? Suppose the table showed: a) a picture of a hammer, of pincers, of a saw, of a chisel; b) on the other hand, pictures of twenty different kinds of butterflies. Imagine what the comparison in these two cases would consist in, and note the difference. Compare with these cases a third case c) where the pictures in the table represent building stones drawn to scale, and the comparing has to be done with ruler and compasses. Suppose that B's task is to bring a piece of cloth of the colour of the sample. How are the colours of sample and cloth to be compared? Imagine a series of different cases:

14). A shows the sample to B, upon which B goes and fetches the material 'from memory'.

15). A gives B the sample, B looks from the sample to the materials on the shelves from which he has to choose.

16). B lays the sample on each bolt of material and chooses that one which he can't distinguish from the sample, for which the difference between the sample and the material seems to vanish.

17). Imagine on the other hand that the order has been, "Bring a material slightly darker than this sample". In 14) I said that B fetches the material 'from memory', which is using a common form of expression. But what might happen in such a case of comparing 'from memory' is of the greatest variety. Imagine a few instances:

14a). B has a memory image before his mind's eye when he goes for the material. He alternately looks at materials and recalls his image. He goes through this process with, say, five of the bolts, in some instances saying to himself, "Too dark", in some instances saying to himself, "Too light". At the fifth bolt he stops, says, "That's it" and takes it from the shelf.

14b). No memory image is before B's eye. He looks at four bolts, shaking his head each time, feeling some sort of mental tension. On reaching the fifth bolt, this tension relaxes, he nods his head, and takes the bolt down.

14c). B goes to the shelf without a memory image, looks at five bolts one after the other, takes the fifth bolt from the shelf.

'But this can't be all comparing consists in.'

When we call these three preceding cases, cases of comparing from memory, we feel that their description is in a sense unsatisfactory, or incomplete. We are inclined to say that the description has left out the essential feature of such a process and given us accessory features only. The essential feature it seems would be what one might call a specific experience of comparing and of recognizing. Now it is queer that on closely looking at cases of comparing,

it is very easy to see a great number of activities and states of mind, all *more or less* characteristic of the act of comparing. This in fact is so, whether we speak of comparing from memory or of comparing by means of a sample before our eyes. We know a *vast* number of such processes, processes similar to each other in a vast number of different ways. We hold pieces whose colours we want to compare together or near each other for a longer or shorter period, look at them alternately or simultaneously, place them under different lights, say different things while we do so, have memory images, feelings of tension and relaxation, satisfaction and dissatisfaction, the various feelings of strain in and around our eyes accompanying prolonged gazing at the same object, and all possible combinations of these and many other experiences. The more such cases we observe and the closer we look at them, the more doubtful we feel about finding one particular mental experience characteristic of comparing. In fact, if after you had scrutinized a number of such *closely*, I admitted that there existed a peculiar mental experience which you might call the experience of comparing, and that if you insisted, I should be willing to adopt the word "comparing" only for cases in which this peculiar feeling had occurred, you would now feel that the assumption of such a peculiar experience had lost its point, because this experience was placed side by side with a vast number of other experiences which after we have scrutinized the cases seems to be that which really constitutes what connects all the cases of comparing. For the 'specific experience' we had been looking for was meant to have played the role which has been assumed by the mass of experiences revealed to us by our scrutiny: We never wanted the specific experience to be just one among a number of *more or less* characteristic experiences. (One might say that there are two ways of looking at this matter, one as it were, at close quarters, the other as though from a distance and through the medium of a peculiar atmosphere.) In fact we have found that the use which we really make of the word "comparing" is different from that which looking at it

Page Break 87

from far away we were led to expect. We find that what connects all the cases of comparing is a vast number of overlapping similarities, and as soon as we see this, we feel no longer compelled to say that there must be some one feature common to them all. What ties the ship to the wharf is a rope, and the rope consists of fibres, but it does not get its strength from any fibre which runs through it from one end to the other, but from the fact that there is a vast number of fibres overlapping.

Page 87

'But surely in case 14c) B acted entirely automatically. If all that happened was really what was described there, he did not know why he chose the bolt he did choose. He had no reason for choosing it. If he chose the right one, he did it as a machine might have done it'. Our first answer is that we did not deny that B in case 14c) had what we should call a personal experience, for we did not say that he didn't see the materials from which he chose or that which he chose, nor that he didn't have muscular and tactile sensations and suchlike while he did it. Now what would such a reason which justified his choice and made it non-automatic be like? (i.e.: What do we *imagine* it to be like?) I suppose we should say that the opposite of automatic comparing, as it were, the ideal case of conscious comparing, was that of having a clear memory image before our mind's eye or of seeing a real sample and of having a specific feeling of not being able to distinguish in a particular way between these samples and the material chosen. I suppose that this peculiar sensation is the reason, the justification, for the choice. This specific feeling, one might say, connects the two experiences of seeing the sample, on the one hand, and the material on the other. But if so, what connects this specific experience with either? We don't deny that such an experience might intervene. But looking at it as we did just now, the distinction between automatic and non-automatic appears no longer clear-cut and final as it did at first. We don't mean that this distinction loses its practical value in particular cases, e.g., if asked under particular circumstances "Did you take this bolt from the shelf automatically, or did you think about it?", we may be justified in saying that we did not act automatically and give as an explanation that we had looked at the material carefully, had tried to recall the memory image of the pattern, and had uttered to ourselves doubts and decisions. This may *in the particular case* be taken to distinguish automatic from non-automatic. In another case, however, we may distinguish between an automatic

Page Break 88

and a non-automatic way of the appearance of a memory image, and so on.

Page 88

If our case 14c) troubles you, you may be inclined to say: "But *why* did he bring just this bolt of material? How has he recognized it as the right one? What by?"--If you ask 'why', do you ask for the cause or for the reason? If for the cause, it is easy enough to think up a physiological or psychological hypothesis which explains this choice under the given conditions. It is the task of the experimental sciences to test such hypotheses. If on the other hand you ask for a reason the answer is, "There need not have been a reason for the choice. A reason is a step preceding the step of the choice. But why should every step be preceded by another one?"

'But then B didn't really *recognize* the material as the right one. You needn't reckon 14c) among the cases of recognizing, but if you have become aware of the fact that the processes which we call processes of recognition form a vast family with overlapping similarities, you will probably feel not disinclined to include 14c) in this family, too.--'But doesn't B in this case lack the criterion by which he can recognize the material? In 14a), e.g., he had the memory image and he recognized the material he looked for by its agreement with the image.--But had he also a picture of this agreement before him, a picture with which he could compare the agreement between the pattern and the bolt to see whether it was the right one? And, on the other hand, couldn't he have been given such a picture? Suppose, e.g., that A wished B to remember that what was wanted was a bolt exactly like the sample, not, as perhaps in other cases, a material slightly darker than the pattern. Couldn't A in this case have given to B an example of the agreement required by giving him two pieces of the same colour (e.g., as a kind of reminder)? Is any such link between the order and its execution necessarily the last one?--And if you say that in 14b) at least he had the relaxing of the tension by which to recognize the right material, had he to have an image of this relaxation about him to recognize it as that by which the right material was to be recognized?--

'But supposing B brings the bolt, as in 14c), and on comparing it with the pattern it turns out to be the wrong one?--But couldn't that have happened in all the other cases as well? Suppose in 14a) the bolt which B brought back was found not to match with the pattern. Wouldn't we in some such cases say that his memory image had changed, in others that the pattern or the material had changed, in

others again that the light had changed? It is not difficult to invent cases, imagine circumstances, in which each of these judgments would be made.--'But isn't there after all an essential difference between the cases 14a) and 14c)?--Certainly! Just that pointed out in the description of these cases.--

In 1) B learnt to bring a building stone on hearing the word "column!" called out. We could imagine what happened in such a case to be this: In B's mind the word called out brought up an image of a column, say; the training had, as we should say, established this association. B takes up that building stone which conforms to his image.--But was this *necessarily* what happened? If the training could bring it about that the idea or image--automatically--arose in B's mind, why shouldn't it bring about B's *actions* without the intervention of an image? This would only come to a slight variation of the associative mechanism. Bear in mind that the image which is brought up by the word is not arrived at by a rational process (but if it is, this only pushes our argument further back), but that this case is strictly comparable with that of a mechanism in which a button is pressed and an indicator plate appears. In fact this sort of mechanism can be used instead of that of association.

Mental images of colours, shapes, sounds, etc., etc., which play a role in communication by means of language we put in the same category with patches of colour actually seen, sounds heard.

18). The object of the training in the use of tables (as in 7)) may be not only to teach the use of one particular table, but it may be to enable the pupil to use or construct himself tables with new co-ordinations of written signs and pictures. Suppose the first table a person was trained to use contained the four words "hammer", "pincers", "saw", "chisel" and the corresponding pictures. We might now add the picture of another object which the pupil had before him, say of a plane, and correlate with it the word "plane". We shall make the correlation between this new picture and word as similar as possible to the correlations in the previous table. Thus we might add the new word and picture on the same sheet, and place the new word under the previous words and the new picture under the previous pictures. The pupil will now be encouraged to make use of the new picture and word without the special training which we gave him when we taught him to use the first table. These acts of encouragement will be of various kinds, and many such acts will only be possible if

the pupil responds, and responds in a particular way. Imagine the gestures, sounds, etc., of encouragement you use when you teach a dog to retrieve. Imagine on the other hand, that you tried to teach a cat to retrieve. As the cat will not respond to your encouragement, most of the acts of encouragement which you performed when you trained the dog are here out of the question.

19). The pupil could also be trained to give things names of his own invention and to bring the objects when the names are called. He is, e.g., presented with a table on which he finds pictures of objects around him on one side

and blank spaces on the other, and he plays the game by writing signs of his own invention opposite the pictures and reacting in the previous way when these signs are used as orders. Or else

Page 90

20). the game may consist in B's constructing a table and obeying orders given in terms of this table. When the use of a table is taught, and the table consists, say, of two vertical columns, the left hand one containing the names, the right hand one the pictures, a name and a picture being correlated by standing on a horizontal line, an important feature of the training may be that which makes the pupil slide his finger from left to right, as it were the training to draw a series of horizontal lines, one below the other. Such training may help to make the transition from the first table to the new item.

Page 90

Tables, ostensive definitions, and similar instruments I shall call rules, in accordance with ordinary usage. The use of a rule can be explained by a further rule.

Page 90

21). Consider this example: We introduce different ways of reading tables. Each table consists of two columns of words and pictures, as above. In some cases they are to be read horizontally from left to right, i.e., according to the scheme:

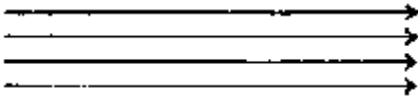

In others according to such schemes as:

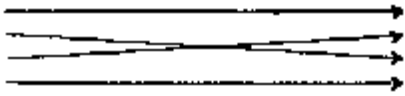

or:

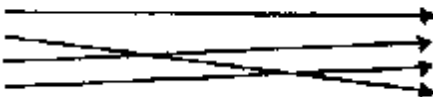

etc.

Page Break 91

Schemes of this kind can be adjoined to our tables, as rules for reading them. Could not these rules again be explained by further rules? Certainly. On the other hand, is a rule incompletely explained if no rule for its usage has been given?

Page 91

We introduce into our language games the endless series of numerals. But how is this done? Obviously the analogy between this process and that of introducing a series of twenty numerals is not the same as that between introducing a series of twenty numerals and introducing a series of ten numerals. Suppose that our game was like 2) but played with the endless series of numerals. The difference between it and 2) would not be just that more numerals were used. That is to say, suppose that as a matter of fact in playing the game we had actually made use of, say, 155 numerals, the game we play would not be that which could be described by saying that we played the game 2), only with 155 instead of 10 numerals. But what does the difference consist in? (The difference would seem to be almost one of the spirit in which the games are played.) The difference between games can lie, say, in the number of the counters used, in the number of squares of the playing board, or in the fact that we use squares in one case and hexagons in the other, and suchlike. Now the difference between the finite and infinite game does not seem to lie in the material tools of the game; for we should be inclined to say that infinity can't be expressed in them, that is, that we can only conceive of it in our thoughts, and hence that it is in these thoughts that the finite and infinite game must be distinguished. (It is queer though that these thoughts should be capable of being expressed in signs.)

Page 91

Let us consider two games. They are both played with cards carrying numbers, and the highest number takes the trick.

Page 91

22). One game is played with a fixed number of such cards, say 32. In the other game we are under certain circumstances allowed to increase the number of cards to as many as we like, by cutting pieces of paper and writing numbers on them. We will call the first of these games bounded, the second unbounded. Suppose a hand of the second game was played and the number of cards actually used was 32. What is the difference in this case between

playing a hand *a*) of the unbounded game and playing a hand *b*) of the bounded game?

Page 91

The difference will not be that between a hand of a bounded game with 32 cards and a hand of a bounded game with a greater number of cards. The number of cards used was, we said, the same. But there

Page Break 92

will be differences of another kind, e.g., the bounded game is played with a normal pack of cards, the unbounded game with a large supply of blank cards and pencils. The unbounded game is opened with the question, "How high shall we go?" If the players look up the rules of this game in a book of rules, they will find the phrase "and so on" or "and so on *ad inf.*" at the end of certain series of rules. So the difference between the two hands *a*) and *b*) lies in the tools we use, though admittedly not in the cards they are played with. But this difference seems trivial and not the essential difference between the games. We feel that there must be a big and essential difference somewhere. But if you look closely at what happens when the hands are played, you find that you can only detect a number of differences in details, each of which would seem inessential. The acts, e.g., of dealing and playing the cards *may* in both cases be identical. In the course of playing the hand *a*), the players may have considered making up more cards, and again discarded the idea. But what was it like to consider this? It could be some such process as saying to themselves or aloud "I wonder whether I should make up another card". Again, no such consideration may have entered the minds of the players. It is possible that the whole difference in the events of a hand of the bounded, and a hand of the unbounded, game lay in what was said before the game started, e.g., "Let's play the bounded game".

Page 92

'But isn't it correct to say that hands of the two different games belong to two different systems?' Certainly. Only the facts which we are referring to by saying that they belong to different systems are much more complex than we might expect them to be.

Page 92

Let us now compare language games of which we should say that they are played with a limited set of numerals, with language games of which we should say that they are played with the endless series of numerals.

Page 92

23). Like 2) A orders B to bring him a number of building stones. The numerals are the signs "1", "2", "9", each written on a card. A has a set of these cards and gives B the order by showing him one of the set and calling out one of the words, "slab", "column", etc.

Page 92

24). Like 23), only there is no set of indexed cards. The series of numerals 1 ... 9 is learned by heart. The numerals are called out in the orders, and the child learns them by word of mouth.

Page Break 93

Page 93

25). An abacus is used. A sets the abacus, gives it to B, B goes with it to where the slabs lie, etc.

Page 93

26). B is to count the slabs in a heap. He does it with an abacus, the abacus has twenty beads. There are never more than 20 slabs in a heap. B sets the abacus for the heap in question and shows A the abacus thus set.

Page 93

27). Like 26). The abacus has 20 small beads and one large one. if the heap contains more than 20 slabs, the large bead is moved. (So the large bead in some way corresponds to the word "many".)

Page 93

28). Like 26). If the heap contains n slabs, n being more than 20 but less than 40, B moves $n-20$ beads, shows A the abacus thus set and claps his hands once.

Page 93

29). A and B use the numerals of the decimal system (written or spoken) up to 20. The child learning this language learns these numerals by heart, as in 2).

Page 93

30). A certain tribe has a language of the kind 2). The numerals used are those of our decimal system. No one numeral used can be observed to play the predominant role of the last numeral in some of the above games (27), 28)). (One is tempted to continue this sentence by saying, "although there is of course a highest numeral actually used".) The children of the tribe learn the numerals in this way: They are taught the signs from 1 to 20 as in 2) and to count rows of beads of no more than 20 on being ordered, "Count these". When in counting the pupil arrives at the numeral 20, one makes a gesture suggestive of "Go on", upon which the child says (in most cases at any rate) "21". Analogously, the children are made to count to 22 and to higher numbers, no particular number playing in these

exercises the predominant role of a last one. The last stage of the training is that the child is ordered to count a group of objects, well above 20, without the suggestive gesture being used to help the child over the numeral 20. If a child does not respond to the suggestive gesture, it is separated from the others and treated as a lunatic.

Page 93

31). Another tribe. Its language is like that in 30). The highest numeral observed in use is 159. In the life of this tribe the numeral 159 plays a peculiar role. Supposing I said, "They treat this number as their highest",--but what does this mean? Could we answer: "They just say that it is the highest"?--They say certain words, but

Page Break 94

how do we know what they mean by them? A criterion for what they mean would be the occasions on which the word we are inclined to translate into our word "highest" is used, the role, we might say, which we observe this word to play in the life of the tribe. In fact we could easily imagine the numeral 159 to be used on such occasions, in connection with such gestures and forms of behaviour as would make us say that this numeral plays the role of an unsurmountable limit, even if the tribe had no word corresponding to our "highest", and the criteria for numeral 159 being the highest numeral did not consist of anything that was *said* about the numeral.

Page 94

32). A tribe has two systems of counting. People learned to count with the alphabet from A to Z and also with the decimal system as in 30.) If a man is to count objects with the first system, he is ordered to count "*in the closed way*", in the second case, "*in the open way*"; and the tribe uses the words "closed" and "open" also for a closed and open door.

Page 94

(Remarks: 23) is limited in an obvious way by the set of cards. 24): Note analogy and lack of analogy between the *limited supply* of cards in 23) and of words in our memory in 24). Observe that the limitation in 26) on the one hand lies in the *tool* (the abacus of 20 beads) and its usage in our game, on the other hand (in a totally different way) in the fact that in the actual practice of playing the game no more than 20 objects are ever to be counted. In 27) that latter kind of limitation was absent, but the large bead rather stressed the limitation of our means. Is 28) a limited or an unlimited game? The practice we have described gives the limit 40. We are inclined to say this game 'has it in it' to be continued indefinitely, but remember that we could also have construed the preceding games as beginnings of a system. In 29) the systematic aspect of the numerals used is even more conspicuous than in 28). One might say that there was no limitation imposed by the tools of this game, if it were not for the remark that the numerals up to 20 are learnt by heart. This suggests the idea that the child is not taught to '*understand*' the system which we see in the decimal notation. Of the tribe in 30) we should certainly say that they are trained to construct numerals indefinitely, that the arithmetic of their language is not a finite one, that their series of numbers has no end. (It is just in such a case when numerals are constructed 'indefinitely' that we say that people have the infinite series of numbers.) 31) might show you what a vast variety of cases can be imagined in which we

Page Break 95

should be inclined to say that the arithmetic of the tribe deals with a finite series of numbers, even in spite of the fact that the way in which the children are trained in the use of numerals suggests no upper limit. In 32) the terms "closed" and "open" (which could by a slight variation of the example be replaced by "limited" and "unlimited") are introduced into the language of the tribe itself. Introduced in that simple and clearly circumscribed game, there is of course nothing mysterious about the use of the word "open". But this word corresponds to our "infinite", and the games we play with the latter differ from 31) only by being vastly more complicated. In other words, our use of the word "infinite" is just as *straightforward* as that of "open" in 31), and our idea that its meaning is 'transcendent' rests on a misunderstanding.)

Page 95

We might say roughly that the unlimited cases are characterized by this: that they are not played with a *definite supply* of numerals, but instead with a *system* for constructing numerals (indefinitely). When we say that someone has been supplied with a system for constructing numerals, we generally think of one of three things: a) of giving him a *training* similar to that described in 30), which, experience teaches us, will make him pass tests of the kind mentioned there; b) of creating a *disposition* in the same man's mind, or brain, to react in that way; c) of supplying him with a *general* rule for the construction of numerals.

Page 95

What do we call a rule? Consider this example:

Page 95

33). B moves about according to rules which A gives him. B is supplied with the following table:

a	→
b	←
c	↑
d	↓

A gives an order made up of the letters in the table, say: "aacadd". B looks up the arrow corresponding to each

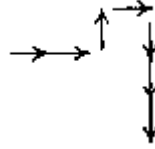

letter of the order and moves accordingly; in our example thus:

The table 33) we should call a rule (or else "the expression of a rule". Why I give these synonymous expressions will appear later.) We shan't be inclined to call the sentence "aacadd" itself a rule. It is of course the description of the way B has to take. On the other hand,

Page Break 96

such a description would under certain circumstances be called a rule, e.g., in the following case:

Page 96

34). B is to draw various ornamental linear designs. Each design is a repetition of one element which A gives

him. Thus if A gives the order "cada", B draws a line thus: 

Page 96

In this case I think we should say that "cada" is the rule for drawing the design. Roughly speaking, it characterizes what we call a rule to be applied repeatedly, in an indefinite number of instances. Cf., e.g., the following case with 34):

Page 96

35). A game played with pieces of various shapes on a chess board. The way each piece is allowed to move is laid down by a rule. Thus the rule for a particular piece is "ac", for another piece "acaa", and so on. The first piece

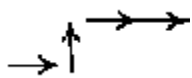
then can make a move like this: , the second, like this: . Both a formula like "ac" or a diagram like that corresponding to such a formula might here be called a rule.

Page 96

36). Suppose that after playing the game 33) several times as described above, it was played with this variation: that B no longer looked at the table, but reading A's order the letters call up the images of the arrows (by association), and B acts according to these imagined arrows.

Page 96

37). After playing it like this for several times, B moves about according to the written order as he would have done had he looked up or imagined the arrows, but actually without any such picture intervening. Imagine even this variation:

Page 96

38). B in being trained to follow a written order, is shown the table of 33) once, upon which he obeys A's orders without further intervention of the table in the same way in which B in 33) does with the help of the table on each occasion.

Page 96

In each of these cases, we might say that the table 33) is a rule of the game. But in each one this rule plays a different role. In 33) the table is an instrument used in what we should call *the practice* of the game. It is replaced in 36) by the working of association. In 37) even this shadow of the table has dropped out of the practice of the game, and in 38) the table is admittedly an instrument for the *training* of B only.

Page 96

But imagine this further case:

Page Break 97

39). A certain system of communication is used by a tribe. I will describe it by saying that it is similar to our game 38) except that no table is used in the training. The training *might* have consisted in several times leading the pupil by the hand along the path one wanted him to go. But we could also imagine a case:

40). where even this training is not necessary, where, as we should say, the look of the letters abcd naturally produced an urge to move in the way described. This case at first sight looks puzzling. We seem to be assuming a most unusual working of the mind. Or we may ask, "How on earth is he to know which way to move if the letter a is shown him?". But isn't B's reaction in this case the very reaction described in 37) and 38), and in fact our usual reaction when for instance we hear and obey an order? For, the fact that the training in 38) and 39) *preceded* the carrying out of the order does not change the process of carrying out. In other words the 'curious mental mechanism' assumed in 40) is no other than that which we assumed to be created by the training in 37) and 38). 'But *could* such a mechanism be born with you?' But did you find any difficulty in assuming that *that* mechanism was born with B, which enabled him to respond to the training in the way he did? And remember that the rule or explanation given in table 33) of the signs abcd was not essentially the last one, and that we might have given a table for the use of such tables, and so on. (Cf. 21).)

How does one explain to a man how he should carry out the order, "Go *this* way!" (pointing with an arrow the way he should go)? Couldn't this mean going the direction which we should call the opposite of that of the arrow? Isn't every explanation of how he should follow the arrow in the position of another arrow? What would you say to this explanation: A man says, "If I point this way (pointing with his right hand) I mean you to go like this" (pointing with his left hand the same way)? This just shows you the extremes between which the uses of signs vary.

Let us return to 39). Someone visits the tribe and observes the use of the signs in their language. He describes the language by saying that its sentences consist of the letters abcd used according to the table (of 33)). We see that the expression, "A game is played according to the rule so and so" is used not only in the variety of cases exemplified by 36), 37), and 38), but even in cases where the rule is neither an instrument of the training nor of the practice of the game, but stands

in the relation to it in which our table stands to the practice of our game 39). One might in this case call the table a natural law describing the behaviour of the people of this tribe. Or we might say that the table is a record belonging to the natural history of the tribe.

Note that in the game 33) I distinguished sharply between the order to be carried out and the rule employed. In 34), on the other hand, we called the sentence "cada" a rule, and it was the order. Imagine also this variation:

41). The game is similar to 33), but the pupil is not just trained to use a single table; but the training aims at making the pupil use any table correlating letters with arrows. Now by this I mean no more than that the training is of a peculiar kind, roughly speaking one analogous to that described in 30). I will refer to a training more or less similar to that in 30) as a "*general training*". General trainings form a family whose members differ greatly from one another. The kind of thing I'm thinking of now mainly consists: *a*) of a training in a limited range of actions, *b*) of giving the pupil a lead to extend this range, and *c*) of random exercises and tests. After the general training the order is now to consist in giving him a sign of this kind:

rrtst

r	↗
r	↖
t	↓

He carries out the order by moving thus:



Here I suppose we should say the table, the rule, is *part* of the order.

Page 98

Note, we are not saying '*what a rule is*' but just giving different applications of the word "rule": and we certainly do this by giving applications of the words "expression of a rule".

Page 98

Note also that in 41) there is no clear case against calling the whole symbol given the sentence, though we *might* distinguish in it between the sentence and the table. What in this case more particularly tempts us to this distinction is the linear writing of the part outside the table. Though from certain points of view we should call the linear character of the sentence merely external and inessential, this character and similar ones play a great role in what as logicians we are inclined to say about sentences and propositions. And therefore if we conceive

Page Break 99

of the symbol in 41) as a unit, this may make us realize what a sentence *can* look like.

Page 99

Let us now consider these two games:

Page 99

42). A gives orders to B: They are written signs consisting of dots and dashes, and B executes them by doing a figure in dancing with a particular step. Thus the order "-- •" is to be carried out by taking a step and a hop alternately; the order "• • -- --" by alternately taking two hops and three steps, etc. The training in this game is 'general' in the sense explained in 41); and I should like to say, "The orders given don't move in a limited range. They comprise combinations of any number of dots and dashes".--But what does it mean to say that the orders don't move in a limited range? Isn't this nonsense? Whatever orders are given in the practice of the game constitute the limited range.--Well, what I meant to say by "The orders don't move in a limited range" was that neither in the teaching of the game nor in the practice of it a limitation of the range plays a 'predominant' role (see 30)), or, as we might say, the range of the game (it is superfluous to say limited) is just the extent of its actual ('accidental') practice. (Our game is in this way like 30).) Cf. with this game the following:

Page 99

43). The orders and their execution as in 42); but only these three signs are used: "--", "-- ••", "• -- --". We say that in 42) B, in executing the order, is *guided* by the sign given to him. But if we ask ourselves whether the three signs in 43) guide B in executing the orders, it seems that we can say both yes and no according to the way we look at the execution of the orders.

Page 99

If we try to decide whether B in 43) is guided by the signs or not, we are inclined to give such answers as the following: a) B is guided if he doesn't just look at an order, say "• -- --" as a whole and then act, but if he reads it 'word by word' (the words used in our language being "•" and "--") and acts according to the words he has read.

Page 99

We could make these cases clearer if we imagine that the 'reading word by word' consisted in pointing to each word of the sentence in turn with one's finger as opposed to pointing at the whole sentence at once, say by pointing to the beginning of the sentence. And the 'acting according to the words' we shall for the sake of simplicity imagine to consist in acting (stepping or hopping) after each word of the sentence in turn.--b) B is guided if he goes through a conscious process which makes a connection between the pointing to a word and the act of hopping and stepping. Such a connection could be

Page Break 100

imagined in many different ways. E.g., B has a table in which a dash is correlated to the picture of a man making a step and a dot to a picture of a man hopping. Then the conscious acts connecting reading the order and carrying it out might consist in consulting the table, or in consulting a memory image of it 'with one's mind's eye'. c) B is guided if he does not just react to looking at each word of the order, but experiences the peculiar strain of 'trying to remember what the sign means', and further, the relaxing of this strain when the meaning, the right action, comes before his mind.

Page 100

All these explanations seem in a peculiar way unsatisfactory, and it is the limitation of our game which

makes them unsatisfactory. This is expressed by the explanation that B is guided by the particular combination of words in one of our three sentences if he *could* also have carried out orders consisting in other combinations of dots and dashes. And if we say this, it seems to us that the 'ability' to carry out other orders is a particular state of the person carrying out the orders of 42). And at the same time we can't in this case find anything which we should call such a state.

Page 100

Let us see what role the words "can" or "to be able to" play in our language. Consider these examples:

Page 100

44). Imagine that for some purpose or other people use a kind of instrument or tool; this consists of a board with a slot in it guiding the movement of a peg. The man using the tool slides the peg along the slot. There are such boards with straight slots, circular slots, elliptic slots, etc. The language of the people using this instrument has expressions for describing the activity of moving the peg in the slot. They talk of moving it in a circle, in a straight line, etc. They also have a means of describing the board used. They do it in this form: "This is a board in which the peg *can* be moved in a circle". One could in this case call the word "can" an operator by means of which the form of expression describing an action is transformed into a description of the instrument.

Page 100

45). Imagine a people in whose language there is no such form of sentence as "the book is in the drawer" or "water is in the glass", but wherever we should use these forms they say, "The book can be taken out of the drawer", "The water can be taken out of the glass".

Page 100

46). An activity of the men of a certain tribe is to test sticks as to their hardness. They do it by trying to bend the sticks with their

Page Break 101

hands. In their language they have expressions of the form, "This stick can be bent easily", or "This stick can be bent with difficulty". They use these expressions as we use "This stick is soft", or "This stick is hard". I mean to say that they don't use the expression, "This stick can be bent easily" as we should use the sentence, "I am bending the stick with ease". Rather they use their expression in a way which would make us say that they are describing a state of the stick. I.e., they use such sentences as, "This hut is built of sticks that can be bent easily". (Think of the way in which we form adjectives out of verbs by means of the ending "able", e.g., "deformable".)

Page 101

Now we might say that in the last three cases the sentences of the form "so and so can happen" described the state of objects, but there are great differences between these examples. In 44) we saw the state described before our eyes. We saw that the board had a circular or a straight slot, etc. In 45), in some instances at least this was the case, we could see the objects in the box, the water in the glass, etc. In such cases we use the expression "state of an object" in such a way that there corresponds to it what one might call a stationary sense experience.

Page 101

When, on the other hand, we talk of the state of a stick in 46), observe that to this 'state' there does not correspond a particular sense experience which lasts while the state lasts. Instead of that, the defining criterion for something being in this state consists in certain *tests*.

Page 101

We may say that a car travels 20 miles an hour even if it only travels for half an hour. We can explain our form of expression by saying that the car travels with a speed which enables it to make 20 miles an hour. And here also we are inclined to talk of the velocity of the car as of a state of its motion. I think we should not use this expression if we had no other 'experiences of motion' than those of a body being in a particular place at a certain time and in another place at another time; if, e.g., our experiences of motion were of the kind which we have when we see that the hour hand of the clock has moved from one point of the dial to the other.

Page 101

47). A tribe has in its language commands for the execution of certain actions of men in warfare, something like "Shoot!", "Run!", "Crawl!", etc. They also have a way of describing a man's build. Such a description has the form "He can run fast", "He can throw the spear far". What justifies me in saying that these sentences are descriptions of the man's build is the use which they make of sentences of this

Page Break 102

form. Thus if they see a man with bulging leg muscles but who as we should say has not the use of his legs for some reason or other, they say he is a man who can run fast. The drawn image of a man which shows large biceps they describe as representing a man "who can throw a spear far".

48). The men of a tribe are subjected to a kind of medical examination before going into war. The examiner puts the men through a set of standardized tests. He lets them lift certain weights, swing their arms, skip, etc. The examiner then gives his verdict in the form "So and so can throw a spear" or "can throw a boomerang" or "is fit to pursue the enemy", etc. There are no special expressions in the language of this tribe for the activities performed in the tests; but these are referred to only as the tests for certain activities in warfare.

It is an important remark concerning this example and others which we give that one may object to the description which we give of the language of a tribe, that in the specimens we give of their language we let them speak English, thereby already presupposing the whole background of the English language, that is, our usual meanings of the words. Thus if I say that in a certain language there is no special verb for "skipping", but that this language uses instead the form "making the test for throwing the boomerang", one may ask how I have characterized the use of the expressions, "make a test for" and "throwing the boomerang", to be justified in substituting these English expressions for whatever their actual words may be. To this we must answer that we have only given a very sketchy description of the practices of our fictitious languages, in some cases only hints, but that one can easily make these descriptions more complete. Thus in 48) I could have said that the examiner uses orders for making the men go through the tests. These orders all begin with one particular expression which I could translate into the English words, "Go through the test". And this expression is followed by one which in actual warfare is used for certain actions. Thus there is a command upon which men throw their boomerangs and which therefore I should translate into, "Throw the boomerangs". Further, if a man gives an account of the battle to his chief, he again uses the expression I have translated into "throw a boomerang", this time in a description. Now what characterizes an order as such, or a description as such,

or a question as such, etc., is--as we have said--the role which the utterance of these signs plays in the whole practice of the language. That is to say, whether a word of the language of our tribe is rightly translated into a word of the English language depends upon the role this word plays in the whole life of the tribe; the occasions on which it is used, the expressions of emotion by which it is generally accompanied, the ideas which it generally awakens or which prompt its saying, etc., etc. As an exercise ask yourself: in which cases would you say that a certain word uttered by the people of the tribe was a greeting? In which cases should we say it corresponded to our "Goodbye", in which to our "Hello"? In which cases would you say that a word of a foreign language corresponded to our "perhaps"?--to our expressions of doubt, trust, certainty? You will find that the justifications for calling something an expression of doubt, conviction, etc., largely, though of course not wholly, consist in descriptions of gestures, the play of facial expressions, and even the tone of voice. Remember at this point that the personal experiences of an emotion must in part be strictly localized experiences; for if I frown in anger I feel the muscular tension of the frown in my forehead, and if I weep, the sensations around my eyes are obviously part, and an important part, of what I feel. This is, I think, what William James meant when he said that a man doesn't cry because he is sad but that he is sad because he cries. The reason why this point is often not understood, is that we think of the utterance of an emotion as though it were some artificial device to let others know that we have it. Now there is no sharp line between such 'artificial devices' and what one might call the natural expressions of emotion. Cf. in this respect: a) weeping, b) raising one's voice when one is angry, c) writing an angry letter, d) ringing the bell for a servant you wish to scold.

49) Imagine a tribe in whose language there is an expression corresponding to our "He has done so and so", and another expression corresponding to our "He can do so and so", this latter expression, however, being only used where its use is justified by the same fact which would also justify the former expression. Now what can make me say this? They have a form of communication which we should call narration of past events because of the circumstances under which it is employed. There are also circumstances under which we should ask and answer such questions as "Can so and so do this?" Such circumstances can be described, e.g., by saying that a chief picks men

suitable for a certain action, say crossing a river, climbing a mountain, etc. As the defining criteria of "the chief picking men suitable for this action", I will not take what he says but only the other features of the situation. The chief under these circumstances asks a question which, as far as its practical consequences go, would have to be translated by our "Can so and so swim across this river?" This question however, is only answered affirmatively by

those who actually have swum across this river. This answer is not given in the same words in which under the circumstances characterizing narration he would say that he has swum across this river, but it is given in the terms of the question asked by the chief. On the other hand, this answer is not given in cases in which we should certainly give the answer, "I can swim across this river", if, e.g., I had performed more difficult feats of swimming though not just that of swimming across this particular river.

Page 104

By the way, have the two phrases "He has done so and so" and "He can do so and so" the same meaning in this language or have they different meanings? If you think about it, something will tempt you to say the one, something to say the other. This only shows that the question has here no clearly defined meaning. All I can say is: If the fact that they only say "He can..." if he has done... is your criterion for the same meaning, then the two expressions have the same meaning. If the circumstances under which an expression is used make its meaning, the meanings are different. The use which is made of the word "can"--the expression of possibility in 49)--can throw a light upon the idea that what can happen must have happened before (Nietzsche). It will also be interesting to look, in the light of our examples, on the statement that what happens can happen.

Page 104

Before we go on with our consideration of the use of 'the expression of possibility', let us get clearer about that department of our language in which things are said about past and future, that is, about the use of sentences containing such expressions as "yesterday", "a year ago", "in five minutes", "before I did this", etc. Consider this example:

Page 104

50). Imagine how a child might be trained in the practice of 'narration of past events'. He was first trained in asking for certain things (as it were, in giving orders. See 1)). Part of this training was the exercise of 'naming the things'. He has thus learnt to name (and ask for) a dozen of his toys. Say now that he has played with three of them (e.g., a ball, a stick, and a rattle), then they are taken away from

Page Break 105

him, and now the grown up says such a phrase as, "He's had a ball, a stick, and a rattle". On a similar occasion he stops short in the enumeration and induces the child to complete it. On another occasion, perhaps, he only says, "He's had..." and leaves the child to give the whole enumeration. Now the way of 'inducing the child to go on' can be this: He stops short in his enumeration with a facial expression and a raised tone of voice which we should call one of expectancy. All then depends on whether the child will react to this 'inducement' or not. Now there is a queer misunderstanding we are most liable to fall into, which consists in regarding the 'outward means' the teacher uses to induce the child to go on as what we might call an indirect means of making himself understood to the child. We regard the case as though the child already possessed a language in which it thought and that the teacher's job is to induce it to guess his meaning in the realm of meanings before the child's mind, as though the child could in his own private language ask himself such a question as, "Does he want me to continue, or repeat what he said, or something else?" (Cf. with 30.)

Page 105

51). Another example of a primitive kind of narration of past events: we live in a landscape with characteristic natural landmarks against the horizon. It is therefore easy to remember the place at which the sun rises at a particular season, or the place above which it stands when at its highest point, or the place at which it sets. We have some characteristic pictures of the sun in different positions in our landscape. Let us call this series of pictures the sun series. We have also some characteristic pictures of the activities of a child, lying in bed, getting up, dressing, lunching, etc. This set I'll call the life pictures. I imagine that the child can frequently see the position of the sun while about the day's activities. We draw the child's attention to the sun's standing in a certain place while the child is occupied in a particular way. We then let it look both at a picture representing its occupation and at a picture showing the sun in its position at that time. We can thus roughly tell the story of the child's day by laying out a row of the life pictures, and above it what I called the sun series, the two rows in the proper correlation. We shall then proceed to let the child supplement such a picture story, which we leave incomplete. And I wish to say at this point that this form of training (see 50) and 30)) is one of the big characteristic features in the use of language, or in thinking.

Page Break 106

Page 106

52). A variation of 51). There is a big clock in the nursery, for simplicity's sake imagine it with an hour hand only. The story of the child's day is narrated as above, but there is no sun series; instead we write one of the numbers of the dial against each life picture.

53). Note that there would have been a similar game in which also, as we might say, time was involved, that of just laying out a series of life pictures. We might play this game with the help of words which would correspond to our "before" and "after". In this sense we may say that 53) involves the ideas of before and after, but not the idea of a measurement of time. I needn't say that an easy step would lead us from the narrations in 51), 52), and 53) to narrations in words. Possibly someone considering such forms of narration might think that in them the real idea of time isn't yet involved at all, but only some crude substitute for it, the positions of a clock hand and suchlike. Now if a man claimed that there is an idea of five o'clock which does not bring in a clock, that the clock is only the coarse instrument indicating when it is five o'clock or that there is an idea of an hour which does not bring in an instrument for measuring the time, I will not contradict him, but I will ask him to explain to me what his use of the term "an hour" or "five o'clock" is. And if it is not that involving a clock, it is a different one; and then I will ask him why he uses the terms "five o'clock", "an hour", "a long time", "a short time", etc., in one case in connection with a clock, in the other independent of one; it will be because of certain analogies holding between the two uses, but we have now two uses of these terms, and no reason to say that one of them is less real and pure than the other. This might get dearer by considering the following example:

54). If we give a person the order "Say a number, any one which comes into your mind", he can generally comply with it at once. Suppose it were found that the numbers thus said on request increased--with every normal person--as the day went on; a man starts out with some small number every morning and reaches the highest number before falling asleep at night. Consider what could tempt one to call the reactions described "a means of measuring time" or even to say that they are the *real* milestones in the passage of time, the sun clocks, etc., being only indirect markers. (Examine the statement that the human heart is the real clock behind all the other clocks.)

Let us now consider further language games into which temporal expressions enter.

55). This arises out of 1). If an order like "slab!", "column!", etc. is called out, B is trained to carry it out immediately. We now introduce a clock into this game, an order is given, and we train the child not to carry it out until the hand of our clock reaches a point indicated before with the finger. (This might, e.g., be done in this way: You first trained the child to carry out the order immediately. You then give the order, but hold the child back, releasing it only when the hand of the clock has reached the point of the dial to which we point with our fingers.)

We could at this stage introduce such a word as "now". We have two kinds of orders in this game, the orders used in 1), and orders consisting of these, together with a gesture indicating a point of the clock dial. In order to make the distinction between these two kinds more explicit, we may affix a particular sign to the orders of the first kind and, e.g., say: "slab, now!".

It would be easy now to describe language games with such expressions as "in five minutes", "half an hour ago".

56). Let us now have the case of a *description* of the future, a forecast. One might, e.g., awaken the tension of expectation in a child by keeping his attention for a considerable time on some traffic lights changing their colour periodically. We also have a red, a green, and a yellow disc before us and alternately point to one of these discs by way of forecasting the colour which will appear next. It is easy to imagine further developments of this game.

Looking at these language games, we don't come across the ideas of the past, the future and the present in their problematic and almost mysterious aspect. What this aspect is and how it comes about that it appears can be almost characteristically exemplified if we look at the question "Where does the present go when it becomes past, and where is the past?"--Under what circumstances has this question an allurements for us? For under certain circumstances it hasn't, and we should wave it away as nonsense.

It is clear that this question most easily arises if we are preoccupied with cases in which there are things flowing by us,--as logs of wood float down a river. In such a case we can say the logs which *have passed* us are all down towards the left and the logs which *will pass* us are all up towards the right. We then use this situation as a simile for all happening in time and even embody the simile in our language, as when we say that 'the present event passes by' (a log passes by),

'the future event is to come' (a log is to come). We talk about the flow of events; but also about the flow of time--the river on which the logs travel.

Here is one of the most fertile sources of philosophic puzzlement: we talk of the future event of something coming into my room, and also of the future coming of this event.

We say, "*Something* will happen", and also, "Something comes towards me"; we refer to the log as "something", but also the log's coming towards me.

Thus it can come about that we aren't able to rid ourselves of the implications of our symbolism, which seems to admit of a question like "Where does the flame of a candle go to when it's blown out?" "Where does the light go to?", "Where does the past go to"? We have become obsessed with our symbolism.--We may say that we are led into puzzlement by an analogy which irresistibly drags us on.--And this also happens when the meaning of the word "now" appears to us in a mysterious light. In our example 55) it appears that the function of "now" is in no way comparable to the function of an expression like "five o'clock", "midday", "the time when the sun sets", etc. This latter group of expressions I might call "specifications of times". But our ordinary language uses the word "now" and specifications of time in similar contexts. Thus we say

"The sun sets at six o'clock".

"The sun is setting now".

We are inclined to say that both "now" and "six o'clock" 'refer to points of time'. This use of words produces a puzzlement which one might express in the question "What is the 'now'?--for it is a moment of time and yet it can't be said to be either the 'moment at which I speak' or 'the moment at which the clock strikes', etc., etc."--Our answer is: The function of the word "now" is entirely different from that of a specification of time.--This can easily be seen if we look at the role this word really plays in our usage of language, but it is obscured when instead of looking at the *whole language game*, we only look at the contexts, the phrases of language in which the word is used. (The word "today" is not a date, but it isn't anything like it either. It doesn't differ from a date as a hammer differs from a mallet, but as a hammer differs from a nail; and surely we may say there is both a connection between a hammer and a mallet and between a hammer and a nail.)

One has been tempted to say that "now" is the name of an instant of

time, and this, of course, would be like saying that "here" is the name of a place, "this" the name of a thing, and "I" the name of a man. (One could, of course, also have said "a year ago" was the name of a time, "over there" the name of a place, and "you" the name of a person.) But nothing is more unlike than the use of the word "this" and the use of a proper name--I mean *the games* played with these words, not the phrases in which they are used. For we do say "This is short" and "Jack is short"; but remember that "This is short" without the pointing gesture and without the thing we are pointing to would be meaningless.--What can be compared with a name is not the word "this" but, if you like, the symbol consisting of this word, the gesture, and the sample. We might say: Nothing is more characteristic of a proper name A than that we can use it in such a phrase as "This is A"; and it makes no sense to say "This is this" or "Now is now" or "Here is here".

The idea of a proposition saying something about what will happen in the future is even more liable to puzzle us than the idea of a proposition about the past. For comparing future events with past events, one may almost be inclined to say that though the past events do not really exist in the full light of day, they exist in an underworld into which they have passed out of the real life; whereas the future events do not even have this shadowy existence. We could, of course, imagine a realm of the unborn, future events, whence they come into reality and pass into the realm of the past; and, if we think in terms of this metaphor, we may be surprised that the future should appear less existent than the past. Remember, however, that the grammar of our temporal expressions is not symmetrical with respect to an origin corresponding with the present moment. Thus the grammar of the expressions relating to memory does not reappear 'with opposite sign' in the grammar of the future tense. This is the reason why it has been said that propositions concerning future events are not really propositions. And to say this is all right as long as it isn't meant to be more than a decision about the use of the term "proposition"; a decision which, though not agreeing with the common usage of the word "proposition", may come natural to human beings under certain

circumstances. If a philosopher says that propositions about the future are not real propositions, it is because he has been struck by the asymmetry in the grammar of temporal expressions. The danger is, however, that he imagines he has made a kind of scientific statement about 'the nature of the future'.

Page Break 110

Page 110

57). A game is played in this way: A man throws a die, and before throwing he draws on a piece of paper some one of the six faces of the die. If, after having thrown, the face of the die turning up is the one he has drawn, he feels (expresses) satisfaction. If a different face turns up, he is dissatisfied. Or, let there be two partners and every time one guesses correctly what he will throw his partner pays him a penny, and if incorrectly, he pays his partner. Drawing the face of the die will under the circumstances of this game be called "making a guess" or "a conjecture".

Page 110

58). In a certain tribe contests are held in running, putting the weight, etc., and the spectators stake possessions on the competitors. The pictures of all the competitors are placed in a row, and what I called the spectator's staking property on one of the competitors consists in laying this property (pieces of gold) under one of the pictures. If a man has placed his gold under the picture of the winner in the competition he gets back his stake doubled. Otherwise he loses his stake. Such a custom we should undoubtedly call betting, even if we observed it in a society whose language held no scheme for stating 'degrees of probability', 'chances' and the like. I assume that the behaviour of the spectators expresses great keenness and excitement before and after the outcome of the bet is known. I further imagine that on examining the placing of the bets I can understand 'why' they were thus placed. I mean: In a competition between two wrestlers, mostly the bigger man is the favourite; or if the smaller, I find that he has shown greater strength on previous occasions, or that the bigger had recently been ill, or had neglected his training, etc. Now this may be so although the language of the tribe does not express reasons for the placing of the bets. That is to say, nothing in their language corresponds to our saying, e.g., "I bet on this man because he has kept fit, whereas the other has neglected his training", and such like. I might describe this state of affairs by saying that my observation has taught me certain *causes* for their placing their bets as they do, but that the bettors used no *reasons* for acting as they did.

Page 110

The tribe may, on the other hand, have a language which comprises 'giving reasons'. Now this game of giving the reason why one acts in a particular way does not involve finding the causes of one's actions (by frequent observations of the conditions under which they arise). Let us imagine this:

Page Break 111

Page 111

59). If a man of our tribe has lost his bet and upon this is chaffed or scolded, he points out, possibly exaggerating, certain features of the man on whom he has laid his bet. One can imagine a discussion of pros and cons going on in this way: two people pointing out alternately certain features of the two competitors whose chances, as we should say, they are discussing; A pointing with a gesture to the great height of the one, B in answer to this shrugging his shoulders and pointing to the size of the other's biceps, and so on. I could easily add more details which would make us say that A and B are giving reasons for laying a bet on one person rather than on the other.

Page 111

Now one might say that giving reasons in this way for laying their bets certainly presupposes that they have observed causal connections between the result of a fight, say, and certain features of the bodies of the fighters, or of their training. But this is an assumption which, whether reasonable or not, I certainly have not made in the description of our case. (Nor have I made the assumption that the bettors give reasons for their reasons.) We should in a case like that just described not be surprised if the language of the tribe contained what we should call expressions of degrees of belief, conviction, certainty. These expressions we could imagine to consist in the use of a particular word spoken with different intonations, or a series of words. (I am not thinking, however, of the use of a scale of probabilities.)--It is also easy to imagine that the people of our tribe accompany their betting by verbal expressions which we translate into "I believe that so and so *can* beat so and so in wrestling," etc.

Page 111

60). Imagine in a similar way conjectures being made as to whether a certain load of gunpowder will be sufficient to blast a certain rock, and the conjecture to be expressed in a phrase of the form "This quantity of gunpowder can blast this rock".

Page 111

61). Compare with 60) the case in which the expression "I shall be able to lift this weight", is used as an

abbreviation for the conjecture "My hand holding this weight will rise if I go through the process (experience) of 'making an effort to lift it'". In the last two cases the word "can" characterized what we should call the expression of a conjecture. (Of course I don't mean that we call the sentence a conjecture because it contains the word "can"; but in calling a sentence a conjecture we referred to the role which the sentence played in the language game; and we translate a word our tribe uses by "can" if

Page Break 112

"can" is the word we should use under the circumstances described.) Now it is clear that the use of "can" in 59), 60), 61) is closely related to the use of "can" in 46) to 49); differing, however in this, that in 46) to 49) the sentences saying that something *could* happen were not expressions of conjecture. Now one might object to this by saying: Surely we are only willing to use the word "can" in such cases as 46) to 49) because it is reasonable to conjecture in these cases what a man will do in the future from the tests he has passed or from the state he is in.

Page 112

Now it is true that I have deliberately made up the cases 46) to 49) so as to make a conjecture of this kind seem reasonable. But I have also deliberately made them up so as *not* to contain a conjecture. We can, if we like, make the hypothesis that the tribe would never use such a form of expression as that used in 49), etc. if experience had not shown them that... etc. But this is an assumption which, though possibly correct, is in no way presupposed in the games 46) to 49) as I have actually described them.

Page 112

62). Let the game be this: A writes down a row of numbers. B watches him and tries to find a system in the sequence of these numbers. When he has done so he says: "Now I can go on". This example is particularly instructive because 'being able to go on' here seems to be something setting in suddenly in the form of a clearly outlined event.--Suppose then that A had written down the row 1, 5, 11, 19, 29. At that point B shouts "Now I can go on". What was it that happened when suddenly he saw how to go on? A great many different things might have happened. Let us assume then that in the present case, while A wrote one number after the other, B busied himself with trying out several algebraic formulae to see whether they fitted. When A had written "19" B had been led to try the formula $a_n = n^2 + n - 1$. A's writing 29 confirms his guess.

Page 112

63). Or, no formula came into B's mind. After looking at the growing row of numbers A was writing, possibly with a feeling of tension and with hazy ideas floating in his mind, he said to himself the words "He's squaring and always adding one more"; then he made up the next number of the sequence and found it to agree with the numbers A then wrote down.--

Page 112

64). Or, the row A wrote down was 2, 4, 6, 8. B looks at it, and says "Of course I can go on", and continues the series of even

Page Break 113

numbers. Or he says nothing, and just goes on. Perhaps when looking at the row 2, 4, 6, 8 which A had written down, he had some sensation, or sensations, often accompanying such words as "That's easy!" A sensation of this kind is, for instance, the experience of a slight, quick intake of breath, what one might call a slight start.

Page 113

Now, should we say that the proposition "B can continue the series", means that one of the occurrences just described takes place? Isn't it dear that the statement "B can continue..." is not the same as the statement that the formula $a_n = n^2 + n - 1$ comes into B's mind? This occurrence might have been all that actually took place. (It is dear, by the way, that it can make no difference to us here whether B has the experience of this formula appearing before his mind's eye, or the experience of writing or speaking the formula, or of picking it out with his eyes from amongst several formulae written down beforehand.) If a parrot had uttered the formula, we should not have said that he could continue the series.--Therefore, we are inclined to say "to be able to..." must mean more than just uttering the formula--and in fact more than any one of the occurrences we have described. And this, we go on, shows that saying the formula was only a symptom of B's being able to go on, and that it was not the ability of going on itself. Now what is misleading in this is that we seem to intimate that there is one peculiar activity, process, or state called "being able to go on" which somehow is hidden from our eyes but manifests itself in those occurrences which we call symptoms (as an inflammation of the mucous membranes of the nose produces the symptom of sneezing). This is the way talking of symptoms, in this case, misleads us. When we say "Surely there must be something else behind the mere uttering of the formula, as this alone we should not call 'being able to...' ", the word "behind" here is certainly used metaphorically, and 'behind' the utterance of the formula may be the circumstances under which it is uttered. It is true, "B can continue..." is not the same as to say "B says the formula...", but it doesn't

follow from this that the expression "B can continue..." refers to an activity other than that of saying the formula, in the way in which "B says the formula" refers to the well-known activity. The error we are in is analogous to this: Someone is told the word "chair" does not mean this particular chair I am pointing to, upon which he looks round the room for the object which the word "chair" does denote. (The case would be even more a striking illustration if he tried to look inside the chair in order to find the real meaning of the word "chair".) It is clear that when with

Page Break 114

reference to the act of writing or speaking the formula etc., we use the sentence "He can continue the series", this must be because of some connection between writing down a formula and actually continuing the series. And the connection in experience of these two processes or activities is clear enough. But this connection tempts us to suggest that the sentence "B can continue..." means something like "B does something which, experience has shown us, generally leads to his continuing the series". But does B, when he says "Now I can go on" really mean "Now I am doing something which, as experience has shown us, etc., etc."? Do you mean that he had this phrase in his mind or that he would have been prepared to give it as an explanation of what he had said? To say the phrase "B can continue..." is correctly used when prompted by such occurrences as described in (62), (63), (64) but that these occurrences justify its use only under certain circumstances (e.g. when experience has shown certain connections) is not to say that the sentence "B can continue..." is short for the sentence which describes all these circumstances, i.e. the whole situation which is the background of our game.

Page 114

On the other hand we should *under certain circumstances* be ready to substitute "B knows the formula", "B has said the formula" for "B can continue the series". As when we ask a doctor "Can the patient walk?", we shall sometimes be ready to substitute for this "Is his leg healed?"--"Can he speak?" under circumstances means "Is his throat all right?", under others (e.g., if he is a small child) it means "Has he learned to speak?"--To the question "Can the patient walk?", the doctor's answer may be "His leg is all right"---We use the phrase "He can walk, as far as the state of his leg is concerned", especially when we wish to oppose this condition for his walking to some other condition, say the state of his spine. Here we must beware of thinking that there is in the nature of the case something which we might call the complete set of conditions, e.g., for his walking; so that the patient, as it were, can't help walking, *must* walk, if all these conditions are fulfilled.

Page 114

We can say: The expression "B can continue the series" is used under different circumstances to make different distinctions. Thus it may distinguish *a*) between the case when a man knows the formula and the case when he doesn't; or *b*) between the case when a man knows the formula and hasn't forgotten how to write the numerals of the decimal system, and the case when he knows the formula and has forgotten how to write the numerals; or *c*) (as perhaps in (64)) between the case when a man is feeling his normal self and the case when he is

Page Break 115

still in a condition of shell-shock; or *d*) between the case of a man who has done this kind of exercise before and the case of a man who is new at it. These are only a few of a large family of cases.

Page 115

The question whether "He can continue..." means the same as "He knows the formula" can be answered in several different ways: We can say "They don't mean the same, i.e., they are not in general used as synonyms as, e.g., the phrases 'I am well' and 'I am in good health'"; or we may say "*Under certain circumstances* 'He can continue...' means he knows the formula". Imagine the case of a language (somewhat analogous to (49)) in which two forms of expression, two different sentences, are used to say that a person's legs are in working order. The one form of expression is exclusively used under circumstances when preparations are going on for an expedition, a walking tour, or the like; the other is used in cases when there is no question of such preparations. We shall here be doubtful whether to say the two sentences have the same meaning or different meanings. In any case the true state of affairs can only be seen when we look into the detail of the usage of our expressions.--And it is clear that if in our present case we should decide to say that the two expressions have different meanings, we shall certainly not be able to say that the difference is that the fact which makes the second sentence true is a different one from the fact which makes the first sentence true.

Page 115

We are justified in saying that the sentence "He can continue..." has a different meaning from this: "He knows the formula". But we mustn't imagine that we can find a particular state of affairs 'which the first sentence refers to', as it were on a plane above that on which the special occurrences (like knowing the formula, imagining certain further terms, etc.) take place.

Page 115

Let us ask the following question: Suppose that, on one ground or another, B has said "I can continue the series", but on being asked to continue it he had shown himself unable to do so should we say that this proved that his statement, that he could continue, was wrong, or should we say that he was able to continue when he said he was? Would B himself say "I see I was wrong", or "What I said was true, I could do it then but I can't now"?--There are cases in which he would correctly say the one and cases in which he would correctly say the other. Suppose *a*) when he said he could continue he saw the formula before his mind, but when he was asked to continue he found he had forgotten it;--or, *b*) when he said he could continue he had said to himself the next five terms of the series, but now finds

Page Break 116

that they don't come into his mind; or, *c*) before, he had continued the series calculating five more places, now he still remembers these five numbers but has forgotten how he had calculated them;--or, *d*) he says "Then I felt I could continue, now I can't";--or, *e*) "When I said I could lift the weight my arm didn't hurt, now it does"; etc.

Page 116

On the other hand we say "I thought I could lift this weight, but I see I can't", "I thought I could say this piece by heart, but I see I was mistaken".

Page 116

These illustrations of the use of the word "can" should be supplemented by illustrations showing the variety of uses we make of the terms "forgetting" and "trying", for these uses are closely connected with those of the word "can". Consider these cases: *a*) Before, B had said to himself the formula, now, "he finds a complete blank there". *b*) Before, he had said to himself the formula, now, for a moment he isn't sure 'whether it was 2^n or 3^n '. *c*) He has forgotten a name and it is 'on the tip of his tongue'. Or, *d*) he is not certain whether he has ever known the name or has forgotten it.

Page 116

Now look at the way in which we use the word "trying": *a*) A man is trying to open a door by pulling as hard as he can. *b*) He is trying to open the door of a safe by trying to find the combination. *c*) He is trying to find the combination by trying to remember it, or *d*) by turning the knobs and listening with a stethoscope. Consider the various processes we call "trying to remember". Compare *e*) trying to move your finger against a resistance (e.g., when someone is holding it), and *f*) when you have intertwined the fingers of both hands in a particular way and feel 'you don't know what to do in order to make a particular finger move'.

Page 116

(Consider also the class of cases in which we say "I can do so and so but I won't": "I could if I tried"--e.g., lift 100 pounds; "I could if I wished"--e.g., say the alphabet.)

Page 116

One might perhaps suggest that the only case in which it is correct to say, without restriction, that I can do a certain thing, is that in which while saying that I can do it, I actually do it, and that otherwise I ought to say "I can do it as far as... is concerned". One may be inclined to think that only in the above case has a person given a real proof of being able to do a thing.

Page 116

65). But if we look at a language game in which the phrase "I can..." is used in this way (i.e., a game in which doing a thing is taken as the only justification for saying that one is able to do it),

Page Break 117

we see that there is not the *metaphysical* difference between this game and one in which other justifications are accepted for saying "I can do so and so". A game of the kind 65), by the way, shows us the real use of the phrase "If something happens it certainly can happen"; an almost useless phrase in our language. It sounds as though it had some very clear and deep meaning, but like most of the general philosophical propositions it is meaningless except in very special cases.

Page 117

66). Make this clear to yourself by imagining a language (similar to 49)) which has two expressions for such sentences as "I am lifting a fifty pound weight"; one expression is used whenever the action is performed as a test (say, before an athletic competition), the other expression is used when the action is not performed as a test.

Page 117

We see that a vast net of family likenesses connects the cases in which the expressions of possibility, "can", "to be able to", etc. are used. Certain characteristic features, we may say, appear in these cases in different combinations: there is, e.g., the element of conjecture (that something will behave in a certain way in the future); the description of the state of something (as a condition for its behaving in a certain way in the future); the account of

certain tests someone or something has passed.--

Page 117

There are, on the other hand, various reasons which incline us to look at the fact of something being possible, someone being able to do something, etc., as the fact that he or it is in a particular state. Roughly speaking, this comes to saying that "A is in the state of being able to do something" is the form of representation we are most strongly tempted to adopt; or, as one could also put it, we are strongly inclined to use the metaphor of something being in a peculiar state for saying that something can behave in a particular way. And this way of representation, or this metaphor, is embodied in the expressions "He is capable of...", "He is able to multiply large numbers in his head", "He can play chess": in these sentences the verb is used in the *present tense*, suggesting that the phrases are descriptions of states which exist at the moment when we speak.

Page 117

The same tendency shows itself in our calling the ability to solve a mathematical problem, the ability to enjoy a piece of music, etc., certain states of the mind; we don't mean by this expression 'conscious mental phenomena'. Rather, a state of the mind in this sense is the state of a hypothetical mechanism, a mind model meant to explain

Page Break 118

the conscious mental phenomena. (Such things as unconscious or subconscious mental states are features of the mind *model*.) In this way also we can hardly help conceiving of memory as of a kind of storehouse. Note also how sure people are that to the ability to add or to multiply or to say a poem by heart, etc., there *must* correspond a peculiar state of the person's brain, although on the other hand they know next to nothing about such psycho-physiological correspondences. We regard these phenomena as manifestations of this mechanism, and their possibility is the particular construction of the mechanism itself.

Page 118

Now looking back to our discussion of 43), we see that it was no real explanation of B's being guided by the signs when we said that B was guided if he *could* also have carried out orders consisting in other combinations of dots and dashes than those of 43). In fact, when we considered the question whether B in 43) was guided by the signs, we were all the time inclined to say some such thing as that we could only decide this question with certainty if we could look into the actual mechanism connecting seeing the signs with acting according to them. For we have a definite picture of what in a mechanism we should call certain parts being guided by others. In fact, the mechanism which immediately suggests itself when we wish to show what in such a case as 43) we should call "being guided by the signs" is a mechanism of the type of a pianola. Here, in the working of the pianola we have a clear case of certain actions, those of the hammers of the piano, being guided by the pattern of the holes in the pianola roll. We could use the expression "The pianola is *reading off* the record made by the perforations in the roll", and we might call patterns of such perforations *complex signs* or *sentences*, opposing their function in a pianola to the function which similar devices have in mechanisms of a different type, e.g., the combination of notches and teeth which form a key bit. The bolt of a lock is caused to slide by this particular combination, but we should not say that the movement of the bolt was guided by the way in which we combined teeth and notches, i.e., we should not say that the bolt moved *according* to the pattern of the key bit. You see here the connection between the idea of being guided and the idea of being able to read new combinations of signs; for we should say that the pianola *can* read *any* pattern of perforations, of a particular kind, it is not built for one particular tune or set of tunes (like a musical box),-whereas the bolt of the lock reacts to that pattern of the key bit only which is predetermined in the construction of the lock.

Page Break 119

We could say that the notches and teeth forming a key bit are not comparable to the words making up a sentence but to the letters making up a word, and that the pattern of the key bit in this sense did not correspond to a complex sign, to a sentence, but to a word.

Page 119

It is clear that although we might use the ideas of such mechanisms as similes for describing the way in which B acts in the games 42) and 43), no such mechanisms are actually involved in these games. We shall have to say that the use which we made of the expression "to be guided" in our examples of the pianola and of the lock is only one use within a family of usages, though these examples may serve as metaphors, ways of representation, for other usages.

Page 119

Let us study the use of the expression "to be guided" by studying the use of the word "reading". By "reading" I here mean the activity of translating script into sounds, also of writing according to dictation or of copying in writing a page of print, and suchlike; reading in this sense does not involve any such thing as understanding what you read. The use of the word "reading" is, of course, extremely familiar to us in the

circumstances of our ordinary life (it would be extremely difficult to describe these circumstances even roughly). A person, say an Englishman, has as a child gone through one of the normal ways of training in school or at home, he has learned to read his language, later on he reads books, newspapers, letters, etc. What happens when he reads the newspaper?--His eyes glide along the printed words, he pronounces them aloud or to himself, but he pronounces certain words just taking their pattern in as a whole, other words he pronounces after having seen their first few letters only, others again he reads out letter by letter. We should also say that he had read a sentence if while letting his eyes glide along it he had said nothing aloud or to himself, but on being asked afterwards what he had read he was able to reproduce the sentence verbatim or in slightly different words. He may also act as what we might call a mere reading machine, I mean, paying no attention to what he spoke, perhaps concentrating his attention on something totally different. We should in this case say that he read if he acted faultlessly like a reliable machine.--Compare with this case the case of a beginner. He reads the words by spelling them out painfully. Some of the words, however, he just guesses from their contexts, or possibly he knows the piece by heart. The teacher then says that he is pretending to read the words, or just that he is not really reading them. If, looking at this example, we asked ourselves what reading was, we should be

Page Break 120

inclined to say that it was a particular conscious mental act. This is the case in which we say "Only he knows whether he is reading; nobody else can really know it". Yet we must admit that as far as the reading of a particular word goes, exactly the same thing might have happened in the beginner's mind when he 'pretended' to read as what happened in the mind of the fluent reader when he read the word. We are using the word "reading" in a different way when we talk about the accomplished reader on the one hand and the beginner on the other hand. What in the one case we call an instance of reading we don't call an instance of reading in the other.--Of course we are inclined to say that what happened in the accomplished reader and in the beginner when they pronounced the word could not have been the same. The difference lying, if not in their conscious states, then in the unconscious regions of their minds, or in their brains. We here imagine two mechanisms, the internal working of which we can see, and this internal working is the real criterion for a person's reading or not reading. But in fact no such mechanisms are known to us in these cases. Look at it in this way:

Page 120

67). Imagine that human beings or animals were used as reading machines; assume that in order to become reading machines they need a particular training. The man who trains them says of some of them that they already can read, of others that they can't. Take a case of one who has so far not responded to the training. If you put before him a printed word he will sometimes make sounds, and every now and then it happens 'accidentally' that these sounds more or less correspond to the printed word. A third person hears the creature under training uttering the right sound on looking at the word "table". The third person says "He's reading", but the teacher answers "No, he isn't, it is mere accident". But supposing now that the pupil on being shown other words and sentences goes on reading them correctly. After a time the teacher says "Now he can read".--But what about the first word "table"? Should the teacher say "I was wrong. He read that, too"?, or should he say "No, he only started reading later"? When did he really begin to read, or: Which was the first word, or the first letter, which he read? It is clear that this question here makes no sense unless I give an 'artificial' explanation such as: "The first word which he reads = the first word of the first hundred consecutive words he reads correctly."--Suppose on the other hand that we used the word "reading" to distinguish between the case when a particular conscious

Page Break 121

process of spelling out the words takes place in a person's mind from the case in which this does not happen.--Then, at least the person who is reading could say that such and such a word was the first which he actually read.--Also, in the different case of a reading machine which is a mechanism connecting signs with the reactions to these signs, e.g., a pianola, we could say "Only after such and such a thing had been done to the machine, e.g., certain parts had been connected by wires, the machine actually read; the first letter which it read was a *d*".--

Page 121

In the case 67), by calling certain creatures "reading machines" we meant only that they react in a particular way to seeing printed signs. No connection between seeing and reacting, no internal mechanism enters into this case. It would be absurd if the trainer had answered to the question whether he read the word "table" or not, "Perhaps he read it", for there is no doubt in this case about what he actually did. The change which took place was one which we might call a change in the general behaviour of the pupil, and we have in this case not given a meaning to the expression "the first word in the new era". (Compare with this the following case:

.....
In our figure a row of dots with large intervals succeeds a row of dots with small intervals. Which is the last dot in

the first sequence and which the first dot in the second? Imagine our dots were holes in the revolving disc of a siren. Then we should hear a tone of low pitch following a tone of high pitch (or vice versa). Ask yourself: At which moment does the tone of low pitch begin and the other end?)

Page 121

There is a great temptation on the other hand to regard the conscious mental act as the only real criterion distinguishing reading from not reading. For we are inclined to say "Surely a man always knows whether he is reading or pretending to read", or "Surely a man always knows when he is really reading". If A tries to make B believe that he is able to read Cyrillic script, cheating him by learning a Russian sentence by heart and then saying it while looking at the printed sentence, we may certainly say that A knows that he is pretending and that his not reading in this case is characterized by a particular personal experience, namely, that of saying the sentence by heart. Also, if A makes a slip in saying it by heart, this experience will be different from that which a person has who makes a slip in *reading*.

Page Break 122

Page 122

68). But supposing now that a man who could read fluently and who was made to read sentences which he had never read before read these sentences, but all the time with the peculiar feeling of knowing the sequence of words by heart. Should we in this case say that he was not reading, i.e., should we regard his personal experience as the criterion distinguishing between reading and not reading?

Page 122

69). Or imagine this case: A man under the influence of a certain drug is shown a group of five signs, not letters of an existing alphabet; and looking at them with all the outward signs and personal experiences of spelling out a word, pronounces the word "ABOVE". (This sort of thing happens in dreams. After waking up we then say, "It seemed to me that I was reading these signs though they weren't really signs at all".) In such a case some people might be inclined to say that he is reading, others that he isn't. We could imagine that after he had spelt out the word "above" we showed him other combinations of the five signs and that he read them consistently with his reading of the first permutation of signs shown to him. By a series of similar tests we might find that he used what we might call an imaginary alphabet. If this was so, we should be more ready to say "He is reading" than "He imagines that he reads, but he doesn't really".

Page 122

Note also that there is a continuous series of intermediary cases between the case when a person knows by heart what is in print before him, and the case in which he spells out the letters of every word without any such help as guessing from the context, knowing by heart, and such like.

Page 122

Do this: Say by heart the series of cardinals from one to twelve.--Now look at the dial of your watch and *read* this sequence of numbers. Ask yourself what in this case you called reading, that is, what did you do to make it reading?

Page 122

Let us try this explanation: A person reads if he *derives* the copy which he is producing from the model which he is copying. (I will use the word "model" to mean that which he is reading off, e.g., the printed sentences which he is reading or copying in writing, or such signs as "-- -- • • --" in 42) and 43) which he is "reading" by his movements, or the scores which a pianist plays off, etc. The word "copy" I use for the sentence spoken or written from the printed one, for the movements made according to such signs as "-- -- • • --", for the movements of the pianist's fingers or the tune which he plays from the scores, etc.) Thus if we had taught a person the Cyrillic alphabet and had

Page Break 123

taught him how each letter was pronounced, if then we gave him a piece printed in the Cyrillic script and he spelt it out according to the pronunciation of each letter as we had taught it, we should undoubtedly say that he was deriving the sound of every word from the written and spoken alphabet taught him. And this also would be a clear case of reading. (We might use the expression, "We have taught him the *rule* of the alphabet".)

Page 123

But let us see; what made us say that he *derived* the spoken words from the printed by means of the rule of the alphabet? Isn't all we know that we told him that this letter was pronounced this way, that letter that way, etc., and that he afterwards read out words in the Cyrillic script? What suggests itself to us as an answer is that he must have shown somehow that he did actually make the transition from the printed to the spoken words by means of the rule of the alphabet which we had given him. And what we mean by his showing this will certainly get clearer if we

alter our example and:

Page 123

70) assume that he reads off a text by transcribing it, say, from block letters into cursive script. For in this case we can assume the rule of the alphabet to have been given in the form of a table which shows the block alphabet and the cursive alphabet in parallel columns. Then the *deriving* the copy from the text we should imagine this way: The person who copies looks up the table for each letter at frequent intervals, or he says to himself such things as, "Now what's a small *a* like?", or he tries to visualize the table, refraining from actually looking at it.--

Page 123

71). But what if, doing all this, he then transcribed an "A" into a "b", a "B" into a "c", and so on? Should we not call this "reading", "deriving", too? We might in this case describe his procedure by saying that he used the table as we should have used it had we not looked straight from left to right like this:



but like this:

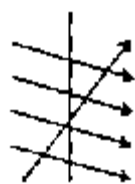

Page Break 124

though he actually when looking up the table passed with his eyes or finger horizontally from left to right.--But let us suppose now

Page 124

72) that going through the normal process of looking up, he transcribed an "A" into an "n", a "B" into an "x", in short, acted, as we might say, according to a scheme of arrows which showed no simple regularity. Couldn't we call this "deriving" too?--But suppose that

Page 124

73) he didn't stick to this way of transcribing. In fact he changed it, but according to a simple rule: After having transcribed "A" into "n", he transcribes the next "A" into "o", and the next "A" into "p", and so on. But where is the sharp line between this procedure and that of producing a transcription without any system at all? Now you might object to this by saying "In the case 71), you obviously assumed that he *understood the table differently*; he didn't understand it in the normal way". But what do we call "understanding the table in a particular way?" But whatever process you imagine this 'understanding' to be, it is only another link interposed between the outward and inward processes of deriving I have described and the actual transcription. In fact this process of understanding could obviously be described by means of a schema of the kind used in 71), and we could then say that in a particular case he looked up the table like this:



understood the table like this:

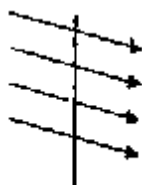

and transcribed it like this:

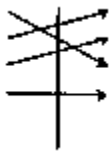

But does this mean that the word "deriving" (or "understanding") has really no meaning, as by following up its meaning this seems to trail off into nothing? In case 70) the meaning of "deriving" stood out quite clearly, but we told ourselves that this was only one special case of deriving. It seemed to us that the essence of the

Page Break 125

process of deriving was here presented in a particular dress and that by stripping it of this we should get at the essence. Now in 71), 72), 73) we tried to strip our case of what had seemed but its peculiar costume only to find that what had seemed mere costumes were the essential features of the case. (We acted as though we had tried to find the real artichoke by stripping it of its leaves.) The use of the word "deriving" is indeed exhibited in 70), i.e., this example showed us one of the family of cases in which this word is used. And the explanation of the use of this word, as that of the use of the word "reading" or "being guided by symbols", essentially consists in describing a selection of examples exhibiting characteristic features, some examples showing these features in exaggeration, others showing transitions, certain series of examples showing the trailing off of such features. Imagine that someone wished to give you an idea of the facial characteristics of a certain family, the So and so's, he would do it by showing you a set of family portraits and by drawing your attention to certain characteristic features, and his main task would consist in the proper *arrangement* of these pictures, which, e.g., would enable you to see how certain influences gradually changed the features, in what characteristic ways the members of the family aged, what features appeared more strongly as they did so.

Page 125

It was not the function of our examples to show us the essence of 'deriving', 'reading', and so forth through a veil of inessential features; the examples were not descriptions of an outside letting us guess at an inside which for some reason or other could not be shown in its nakedness. We are tempted to think that our examples are *indirect* means for producing a certain image or idea in a person's mind,--that they *hint* at something which they cannot show. This would be so in some such case as this: Suppose I wish to produce in someone a mental image of the inside of a particular eighteenth-century room which he is prevented from entering. I therefore adopt this method: I show him the house from the outside, pointing out the windows of the room in question, I further lead him into other rooms of the same period.--

Page 125

Our method is *purely descriptive*; the descriptions we give are not hints of explanations.

Page Break 126

Page Break 127

II

Page 127

1. Do we have a feeling of familiarity whenever we look at familiar objects? Or do we have it usually?

Page 127

When do we actually have it?

Page 127

It helps us to ask: What do we contrast the feeling of familiarity with?

Page 127

One thing we contrast it with is surprise.

Page 127

One could say: "Unfamiliarity is much more of an experience than familiarity".

Page 127

We say: A shows B a series of objects. B is to tell A whether the object is familiar to him or not. *a*) The question may be "Does B know what the objects are?" or *b*) "Does he recognize the particular object?"

Page 127

1). Take the case that B is shown a series of apparatus--a balance, a thermometer, a spectroscope, etc.

Page 127

2). B is shown a pencil, a pen, an inkpot, and a pebble. Or:

Page 127

3). Besides familiar objects he is shown an object of which he says "That looks as though it served some

purpose, but I don't know what purpose".

Page 127

What happens when B recognizes something as a pencil?

Page 127

Suppose A had shown him an object looking like a stick. B handles this object, suddenly it comes apart, one of the parts being a cap, the other a pencil. B says "Oh, this is a pencil". He has recognized the object as a pencil.

Page 127

4). We could say "B always knew what a pencil looked like; he could, e.g., have drawn one on being asked to. He didn't know that the object he was given contained a pencil which he could have drawn any time". Compare with this case 5):

Page 127

5). B is shown a word written on a piece of paper held upside down. He does not recognize the word. The paper is gradually turned round until B says "Now I see what it is. It is 'pencil'".

Page 127

We might say "He always knew what the word 'pencil' looked like. He did not know that the word he was shown would, when turned round, look like 'pencil'".

Page 127

In both cases 4) and 5) you might say something was hidden. But note the different application of "hidden".

Page Break 128

Page 128

6). Compare with this: You read a letter and can't read one of its words. You guess what it must be from the context, and now can read it. You recognize this scratch as an *e*, the second as an *a*, the third as a *t*. This is different from the case where the word "eat" was covered by a blotch of ink, and you only guessed that the word "eat" must have been in this place.

Page 128

7). Compare: You see a word and can't read it. Someone alters it slightly by adding a dash, lengthening a stroke, or such like. Now you can read it. Compare this alteration with the turning in 5), and note that there is a sense in which while the word was turned round you saw that it was *not* altered. I.e., there is a case in which you say "I looked at the word while it was turned, and I know that it is the same now as it was when I didn't recognize it".

Page 128

8). Suppose the game between A and B just consisted in this, that B should say whether he knows the object or not but does not say what it is. Suppose he was shown an ordinary pencil, after having been shown a hygrometer which he had never seen before. On being shown the hygrometer he said that he was not familiar with it, on being shown the pencil, that he knew it. What happened when he recognized it? Must he have told himself, though he didn't tell A, that what he saw was a pencil? Why should we assume this?

Page 128

Then, when he recognized the pencil, what did he recognize it as? 9). Suppose even that he had said to himself "Oh, this is a pencil", could you compare this case with 4) or 5)? In these cases one might have said "He recognized this as that" (pointing, e.g., for "this" to the covered up pencil and for "that" to an ordinary pencil, and similarly in 5)).

Page 128

In 8) the pencil underwent no change and the words "Oh, this is a pencil" did not refer to a paradigm, the similarity of which with the pencil shown B had recognized.

Page 128

Asked "What is a pencil?", B would not have pointed to another object as the paradigm or sample, but could straight away have pointed to the pencil shown to him.

Page 128

"But when he said 'Oh, this is a pencil', how did he know that it was if he didn't recognize it as something?"--This really comes to saying "How did he recognize 'pencil' as the name of this sort of thing?" Well, how did he recognize it? He just reacted in this particular way by saying this word.

Page 128

10). Suppose someone shows you colours and asks you to name them.

Page Break 129

Pointing to a certain object you say "This is red". What would you answer if you were asked "How do you know that this is red?"?

Of course there is the case in which a general explanation was given to B, say, "We shall call 'pencil' anything that one can easily write with on a wax tablet." Then A shows B amongst other objects a small pointed object, and B says "Oh, this is a pencil", after having thought "One could write with this quite easily". In this case, we may say, a *derivation* takes place. In 8), 9), 10) there is no derivation. In 4) we might say that B derived that the object shown to him was a pencil by means of a paradigm, or else no such derivation might have taken place.

Now should we say that B on seeing the pencil after seeing instruments which he didn't know had a feeling of familiarity? Let us imagine what really might have happened. He saw a pencil, smiled, felt relieved, and the name of the object he saw came into his mind or mouth.

Now isn't the feeling of relief just that which characterizes the experience of passing from unfamiliar to familiar things?

2. We say we experience tension and relaxation, relief, strain and rest in cases as different as these: A man holds a weight with outstretched arm; his arm, his whole body is in a state of tension. We let him put down the weight, the tension relaxes. A man runs, then rests. He thinks hard about the solution of a problem in Euclid, then finds it, and relaxes. He tries to remember a name, and relaxes on finding it.

What if we asked "What do all these cases have in common that makes us say that they are cases of strain and relaxation?"?

What makes us use the expression "seeking in our memory", when we try to remember a word?

Let us ask the question "What is the similarity between looking for a word in your memory and looking for my friend in the park?" What would be the answer to such a question?

One kind of answer certainly would consist in describing a series of intermediate cases. One might say that the case which looking in your memory for something is most similar to is not that of looking for my friend in the park, but, say, that of looking up the spelling of a word in a dictionary. And one might go on interpolating cases. Another way of *pointing out* the similarity would be to say, e.g., "In

both these cases at first we can't write down the word and then we can". This is what we call pointing out a common feature.

Now it is important to note that we needn't be aware of such similarities thus pointed out when we are prompted to use the words "seeking", "looking for", etc., in the case of trying to remember.

One might be inclined to say "Surely a similarity must strike us, or we shouldn't be moved to use the same word".--Compare that statement with this: "A similarity between these cases must strike us in order that we should be inclined to use the same picture to represent both". This says that some act must precede the act of using this picture. But why shouldn't what we call "the similarity striking us" consist partially or wholly in our using the same picture? And why shouldn't it consist partially or wholly in our being prompted to use the same phrase?

We say: "This picture (or this phrase) suggests itself to us irresistibly". Well, isn't this an experience?

We are treating here of cases in which, as one might roughly put it, the grammar of a word seems to suggest the 'necessity' of a certain intermediary step, although in fact the word is used in cases in which there is no such intermediary step. Thus we are inclined to say: "A man *must* understand an order before he obeys it", "He must know where his pain is before he can point to it", "He must know the tune before he can sing it", and suchlike.

Let us ask the question: Suppose I had explained to someone the word "red" (or the meaning of the word "red") by having pointed to various red objects and given the ostensive explanation.--What does it mean to say "Now if he has understood the meaning, he will bring me a red object if I ask him to"? This seems to say: If he has really got hold of what is in common between all the objects I have shown him, he will be in the position to follow my order. But what is it that is in common to these objects?

Could you tell me what is in common between a light red and a dark red? Compare with this the following case: I show you two pictures of two different landscapes. In both pictures, amongst many other objects, there is the picture of a bush, and it is exactly alike in both. I ask you "Point to what these two pictures have in common", and as an answer you point to this bush.

Now consider this explanation: I give someone two boxes containing various things, and say "The object which both boxes have in common is called a toasting fork". The person I give this explanation has to

sort out the objects in the two boxes until he finds the one they have in common, and thereby, we may say, he arrives at the ostensive explanation. Or, this explanation: "In these two pictures you see patches of many colours; the one colour which you find in both is called 'mauve'".--In this case it makes a dear sense to say "If he has seen (or found) what is in common between these two pictures, he can now bring me a mauve object".

There is also this case: I say to someone "I shall explain to you the word 'w' by showing you various objects. What's in common to them all is what 'w' means." I first show him two books, and he asks himself "Does 'w' mean 'book'?" I then point to a brick, and he says to himself "Perhaps 'w' means 'parallelepiped'". Finally I point to glowing coal, and he says to himself "Oh, it's 'red' he means, for all these objects had something red about them". It would be interesting to consider another form of this game where the person has at each stage to *draw* or *paint* what he thinks I mean. The interest of this version lies in this, that in some cases it would be quite obvious what he has got to draw, say, when he sees that all the objects I have shown him so far bear a certain trademark (he'd draw the trade mark).--What, on the other hand, should he paint if he recognizes that there is something red about each object? A red patch? And of what shape and shade? Here a convention would have to be laid down, say, that painting a red patch with ragged edges does not mean that the objects have that red patch with ragged edges in common, but *something* red.

If, pointing to patches of various shades of red, you asked a man "What have these in common that makes you call them red?", he'd be inclined to answer "Don't you see?" And this of course would not be pointing out a common element.

There are cases where experience teaches us that a person is not able to carry out an order, say, of the form "Bring me x" if he did not see what was in common between the various objects to which I pointed as an explanation of "x". And 'seeing what they have in common' in some cases consisted in pointing to it, in letting one's glance rest on a coloured patch after a process of scrutiny and comparing, in saying to oneself "Oh, it's red he means", and perhaps at the same time glancing at all the red patches on the various objects, and so on.--There are cases, on the other hand, in which no process takes place comparable with this intermediary 'seeing what's in common', and where we still use this phrase, though this time we ought to say

"If after showing him these things he brings me another red object, then *I shall say* that he has seen the common feature of the objects I showed him". Carrying out the order is now the criterion for his having understood.

3. 'Why do you call "strain" all these different experiences?'--'Because they have some element in common.'-'What is it that bodily and mental strain have in common?'--'I don't know, but obviously there is some similarity.'

Then why did you say the experiences had something in common? Didn't this expression just compare the present case with those cases in which we primarily say that two experiences have something in common? (Thus we might say that some experiences of joy and of fear have the feeling of heart-beat in common.) But when you said that the two experiences of strain had something in common, these were only different words for saying that they were similar. It was then no explanation to say that the similarity consisted in the occurrence of a common element.

Also, shall we say that you had a feeling of similarity when you compared the two experiences, and that this made you use the same word for both? If you say you have a feeling of similarity, let us ask a few questions about it:

Could you say the feeling was located here or there?

When did you actually have this feeling? For, what we call comparing the two experiences is quite a complicated activity: perhaps you called the two experiences before your mind, and imagining a bodily strain, and imagining a mental strain, was each in itself imagining a process and not a state uniform through time. Then ask yourself at what time during all this you had the feeling of similarity.

'But surely I wouldn't say they are similar if I had no experience of their similarity.'--But must this experience be anything you should call a feeling? Suppose for a moment it were the experience that the word "similar" suggested itself to you. Would you call this a feeling?

'But is there no feeling of similarity?'--I think there are feelings which one might call feelings of similarity. But you don't always have any such feeling if you 'notice similarity'. Consider some of the different experiences which you have if you do so.

a) There is a kind of experience which one might call being hardly able to distinguish. You see, e.g., two lengths, two colours, almost exactly alike. But if I ask myself "Does this experience consist in

having a peculiar feeling?", I should have to say that it certainly isn't characterized by any such feeling alone, that a most important part of the experience is that of letting my glance oscillate between the two objects, fixing it intently now on the one, now on the other, perhaps saying words expressive of doubt, shaking my head, etc., etc. There is, one might say, hardly any room left for a feeling of similarity between these manifold experiences.

b) Compare with this the case in which it is impossible to have any difficulty in distinguishing the two objects. Supposing I say "I like to have the two kinds of flowers in this bed of similar colours to avoid a strong contrast". The experience here might be one which one may describe as an easy sliding of the glance from one to the other.

c) I listen to a variation on a theme and say "I don't see yet how this is a variation of the theme, but I see a certain similarity". What happened was that at certain points of the variation, at certain turning points of the key, I had an experience of 'knowing where I was in the theme'. And this experience might again have consisted in imagining certain figures of the theme, or in seeing them written before my mind or in actually pointing to them in the score, etc.

'But when two colours are similar, the experience of similarity should surely consist in noticing the similarity which there *is* between them'--But is a bluish green similar to a yellowish green or not? In certain cases we should say they are similar and in others that they are most dissimilar. Would it be correct to say that in the two cases we noticed different relations between them? Suppose I observed a process in which a bluish green gradually changed into a pure green, into a yellowish green, into yellow, and into orange. I say "It only takes a short time from bluish green to yellowish green, because these colours are similar".--But mustn't you have had some experience of similarity to be able to say this?--The experience may be this, of seeing the two colours and saying that they are both green. Or it may be this, of seeing a band whose colour changes from one end to the other in the way described, and having some one of the experiences which one may call noticing how close to each other bluish green and yellowish green are, compared to bluish green and orange.

We use the word "similar" in a huge family of cases.

There is something remarkable about saying that we use the word "strain" for both mental and physical strain because there is a similarity between them. Should you say we use the word "blue" both for light blue and dark blue because there is a similarity between them? If

you were asked "Why do you call this 'blue' also?", you would say "Because this is blue, too".

One might suggest that the explanation is that in this case you call 'blue' what is *in common* between the two colours, and that, if you called 'strain' what was in common between the two experiences of strain, it would have been wrong to say "I called them both 'strain' because they had a certain similarity", but that you would have had to

say "I used the word 'strain' in both cases because there is a strain present in both".

Page 134

Now what should we answer to the question "What do light blue and dark blue have in common?"? At first sight the answer seems obvious: "They are both shades of blue". But this is really a tautology. So let us ask "What do these colours I am pointing to have in common?" (Suppose one is light blue, the other dark blue.) The answer to this really ought to be "I don't know what game you are playing". And it depends upon this game whether I should say they had anything in common, and what I should say they had in common.

Page 134

Imagine this game: A shows B different patches of colours and asks him what they have in common. B is to answer by pointing to a particular primary colour. Thus if A points to pink and orange, B is to point to pure red. If A points to two shades of greenish blue, B is to point to pure green and pure blue, etc. If in this game A showed B a light blue and a dark blue and asked what they had in common, there would be no doubt about the answer. If then he pointed to pure red and pure green, the answer would be that these have nothing in common. But I could easily imagine circumstances under which we should say that they had something in common and would not hesitate to say what it was: Imagine a use of language (a culture) in which there was a common name for green and red on the one hand and yellow and blue on the other. Suppose, e.g., that there were two castes, one the patrician caste, wearing red and green garments the other, the plebeian, wearing blue and yellow garments. Both yellow and blue would always be referred to as plebeian colours, green and red as patrician colours. Asked what a red patch and a green patch have in common, a man of our tribe would not hesitate to say they were both patrician.

Page 134

We could also easily imagine a language (and that means again a culture) in which there existed no common expression for light blue and dark blue, in which the former, say, was called "Cambridge",

Page Break 135

the latter "Oxford". If you ask a man of this tribe what Cambridge and Oxford have in common, he'd be inclined to say "Nothing".

Page 135

Compare this game with the one above: B is shown certain pictures, combinations of coloured patches. On being asked what these pictures have in common, he is to point to a sample of red, say, if there is a red patch in both, to green if there is a green patch in both, etc. This shows you in what different ways this same answer may be used.

Page 135

Consider such an explanation as "I mean by 'blue' what these two colours have in common".--Now isn't it possible that someone should understand this explanation? He would, e.g., on being ordered to bring another blue object, carry out this order satisfactorily. But perhaps he will bring a red object and we shall be inclined to say: "He seems to notice some sort of similarity between samples we showed him and that red thing".

Page 135

Note: Some people when asked to sing a note which we strike for them on the piano, regularly sing the fifth of that note. That makes it easy to imagine that a language might have one name only for a certain note and its fifth. On the other hand we should be embarrassed to answer the question: What do a note and its fifth have in common? For of course it is no answer to say: "They have a certain affinity".

Page 135

It is one of our tasks here to give a picture of the grammar (the use) of the word "a certain".

Page 135

To say that we use the word "blue" to mean 'what all these shades of colour have in common' by itself says nothing more than that we use the word "blue" in all these cases.

Page 135

And the phrase "He sees what all these shades have in common", may refer to all sorts of different phenomena, i.e., all sorts of phenomena are used as criteria for 'his seeing that...'. Or all that happens may be that on being asked to bring another shade of blue he carries out our order satisfactorily. Or a patch of pure blue may appear before his mind's eye when we show him the different samples of blue: or he may instinctively turn his head towards some other shade of blue which we haven't shown him for sample, etc., etc.

Page 135

Now should we say that a mental strain and a bodily strain were 'strains' in the same sense of the word or in different (or 'slightly different') senses of the word?--There are cases of this sort in which we should not be doubtful about the answer.

Page 135

4. Consider this case: We have taught someone the use of the words "darker" and "lighter". He could, e.g.,

carry out such an order

Page Break 136

as "Paint me a patch of colour darker than the one I am showing you". Suppose now I said to him: "Listen to the five vowels a, e, i, o, u and arrange them in order of their darkness". He may just look puzzled and do nothing, but he may (and some people will) now arrange the vowels in a certain order (mostly i, e, a, o, u). Now one might imagine that arranging the vowels in order of darkness presupposed that when a vowel was sounded a certain colour came before a man's mind, that he then arranged these colours in their order of darkness and told you the corresponding arrangement of the vowels. But this actually need not happen. A person will comply with the order: "Arrange the vowels in their order of darkness", without seeing any colours before his mind's eye.

Page 136

Now if such a person was asked whether u was *really* darker than e, he would almost certainly answer some such thing as "It isn't really darker, but it somehow gives me a darker impression".

Page 136

But what if we asked him "What made you use the word 'darker' in this case at all?"?

Page 136

Again we might be inclined to say "He must have seen something that was in common both to the relation between two colours and to the relation between two vowels". But if he isn't capable of specifying what this common element was, this leaves us just with the fact that he was prompted to use the words "darker", "lighter" in both these cases.

Page 136

For, note the word "must" in "He must have seen something...". When you said that, you didn't mean that from past experience you conclude that he probably did see something, and that's just why this sentence adds nothing to what we know, and in fact only suggests a different form of words to describe it.

Page 136

If someone said: "I do see a certain similarity, only I can't describe it", I should say: "This itself characterizes your experience".

Page 136

Suppose you look at two faces and say "They are similar, but I don't know what it is that's similar about them". And suppose that after a while you said: "Now I know; their eyes have the same shape", I should say "Now your experience of their similarity is different from what it was when you saw similarity and didn't know what it consisted in". Now to the question "What made you use the word 'darker'...?" the answer may be "Nothing made me use the word 'darker',--that is, if you ask me for a *reason* why I use it. I just used it, and what is more, I used it with the same intonation of voice, and perhaps with the same facial expression and gesture, which I should in certain

Page Break 137

cases be inclined to use when applying the word to colours".--It is easier to see this when we speak of a *deep* sorrow, a *deep* sound, a *deep* well. Some people are able to distinguish between fat and lean days of the week. And their experience when they conceive a day as a fat one consists in applying this word together perhaps with a gesture expressive of fatness and a certain comfort.

Page 137

But you may be tempted to say: This use of the word and gesture is not their primary experience. First of all they have to conceive the day as fat and then they express this conception by word or gesture.

Page 137

But why do you use the expression "They have to"? Do you know of an experience in this case which you call "the conception, etc."? For if you don't, isn't it just what one might call a linguistic prejudice that made you say "He had to have a conception before... etc."?

Page 137

Rather, you can learn from this example and from others that there are cases in which we may call a particular experience "noticing, seeing, conceiving that so and so is the case", before expressing it by word or gestures, and that there are other cases in which if we talk of an experience of conceiving at all, we have to apply this word to the experience of using certain words, gestures, etc.

Page 137

When the man said "u isn't really darker than e... ", it was essential that he meant to say that the word "darker" was used *in different senses* when one talked of one colour being darker than another and, on the other hand, of one vowel being darker than another.

Page 137

Consider this example: Suppose we had taught a man to use the words "green", "red", "blue" by pointing to patches of these colours. We had taught him to fetch us objects of a certain colour on being ordered "Bring me something red!", to sort out objects of various colours from a heap, and such like. Suppose we now show him a heap of leaves, some of which are a slightly reddish brown, others a slightly greenish yellow, and give him the order "Put the red leaves and the green leaves on separate heaps". It is quite likely that he will upon this separate the greenish yellow leaves from the reddish brown ones. Now should we say that we had here used the words "red" and "green" in the same sense as in the previous cases, or did we use them in different but similar senses? What reasons would one give for adopting the latter view? One could point out that on being asked to paint a red patch, one should certainly not have painted a slightly reddish brown one, and therefore one might say "red" means something different in the two cases. But why shouldn't I say that it had one meaning only but was, of course, used according to the circumstances?

Page Break 138

Page 138

The question is: Do we supplement our statement that the word has two meanings by a statement saying that in one case it had this, in the other that meaning? As the criterion for a word's having two meanings, we may use the fact of there being two explanations given for a word. Thus we say the word "bank" has two meanings; for in one case it means this sort of thing (pointing, say, to a river bank), in the other case that sort of thing (pointing to the Bank of England). Now what I point to here are paradigms for the use of the words. One could not say: "The word 'red' has two meanings because in one case it means this (pointing to a light red), in the other that (pointing to a dark red)", if, that is to say, there had been only one ostensive definition for the word "red" used in our game. One could, on the other hand, imagine a language game in which two words, say "red" and "reddish", were explained by two ostensive definitions, the first showing a dark red object, the second a light red one. Whether two such explanations were given or only one might depend on the natural reactions of the people using the language. We might find that a person to whom we give the ostensive definition, "This is called 'red'" (pointing to one red object) thereupon fetches any red object of whatever shade of red on being ordered: "Bring me something red!" Another person might not do so, but bring objects of a certain range of shades only in the neighbourhood of the shade pointed out to him in the explanation. We might say that this person 'does not see what is in common between all the different shades of red'. But remember please that our only criterion for that is the behaviour we have described.

Page 138

Consider the following case: B has been taught a use of the words "lighter" and "darker". He has been shown objects of various colours and has been taught that one calls this a darker colour than that, trained to bring an object on being ordered "Bring something darker than this", and to describe the colour of an object by saying that it is darker or lighter than a certain sample, etc., etc. Now he is given the order to put down a series of objects, arranging them in the order of their darkness. He does this by laying out a row of books, writing down a series of names of animals, and by writing down the five vowels in the order u, o, a, e, i. We ask him why he put down that latter series, and he says, "Well, o is lighter than u, and e lighter than o".--We shall be astonished at his attitude, and at the same time admit that there is something in what he says. Perhaps we shall say: "But look, surely e isn't lighter than o in the way this book is lighter than

Page Break 139

that".--But he may shrug his shoulders and say, "I don't know, but e *is* lighter than o, isn't it?"

Page 139

We may be inclined to treat this case as some kind of abnormality, and to say, "B must have a different sense, with the help of which he arranges both coloured objects and vowels". And if we tried to make this idea of ours (quite) explicit, it would come to this: The normal person registers lightness and darkness of visual objects on one instrument, and, what one might call the lightness and darkness of sounds (vowels) on another, in the sense in which one might say that we record rays of a certain wave length with the eyes, and rays of another range of wave length with our sense of temperature. B on the other hand, we wish to say, arranges both sounds and colours by the readings of one instrument (sense organ) only (in the sense in which a photographic plate might record rays of a range which we could only cover with two of our senses).

Page 139

This roughly is the picture standing behind our idea that B must have 'understood' the word "darker" differently from the normal person. On the other hand let us put side by side with this picture the fact that there is in our case no evidence for 'another sense'.--And in fact the use of the word "must" when we say "B must have understood the word differently" already shows us that this sentence (really) expresses our determination to look at the phenomena we have observed after†1 the picture outlined in this sentence.

'But surely he used "lighter" in a different sense when he said e was lighter than u'.--What does this mean? Are you distinguishing between the sense in which he used the word and his usage of the word? That is, do you wish to say that if someone uses the word as B does, some other difference, say in his mind, must go along with the difference in usage? Or is all you want to say that surely the usage of "lighter" was a different one when he applied it to vowels?

Now is the fact that the usages differ anything over and above what you describe when you point out the particular differences?

What if somebody said, pointing to two patches which I had called red, "Surely you are using the word 'red' in two different ways"?--I should say "This is light red and the other dark red,--but why should I have to talk of two different usages?"--

It certainly is easy to point out differences between that part of the game in which we applied "lighter" and "darker" to coloured objects and that part in which we applied these words to vowels. In the first

part there was comparison of two objects by laying them side by side and looking from one to the other, there was painting a darker or lighter shade than a certain sample given; in the second there was no comparison by the eye, no painting, etc. But when these differences are pointed out, we are still free to speak of two parts of the same game (as we have done just now) or of two different games.

'But don't I perceive that the relation between a lighter and a darker bit of material is a different one than that between the vowels e and u,--as on the other hand I perceive that the relation between u and e is the same as that between e and i?'--Under certain circumstances we shall in these cases be inclined to talk of different relations, under certain others to talk of the same relation. One might say, "It depends how one compares them".

Let us ask the question "Should we say that the arrows \rightarrow and \leftarrow point in the same direction or in different directions?"--At first sight you might be inclined to say "Of course, in different directions". But look at it this way: If I look into a looking glass and see the reflection of my face, I can take this as a criterion for seeing my own head. If on the other hand I saw in it the back of a head I might say "It can't be my own head I am seeing, but a head looking in the opposite direction". Now this could lead me on to say that an arrow and the reflection of an arrow in a glass have the same direction when they point towards each other, and opposite directions when the head of the one points to the tail end of the other. Imagine the case that a man had been taught the ordinary use of the word "the same" in the cases of "the same colour", "the same shape", "the same length". He had also been taught the use of the word "to point to" in such contexts as "The arrow points to the tree". Now we show him two arrows facing each other, and two arrows one following the other, and ask him in which of these two cases he'd apply the phrase "The arrows point the same way". Isn't it easy to imagine that if certain applications were uppermost in his mind, he would be inclined to say that the arrows $\rightarrow \leftarrow$ point 'the same way'?

When we hear the diatonic scale we are inclined to say that after every seven notes the same note recurs, and, asked why we call it the same note again one might answer "Well, it's a c again". But this isn't the explanation I want, for I should ask "What made one call it a c again?" And the answer to this would seem to be "Well, don't you hear that it's the same note only an octave higher?"--Here, too, we could imagine that a man had been taught our use of the word

"the same" when applied to colours, lengths, directions, etc., and that we now played the diatonic scale for him and asked him whether he'd say that he heard the same notes again and again at certain intervals, and we could easily imagine several answers, in particular for instance, this, that he heard the same note alternately after every four or three notes (he calls the tonic, the dominant, and the octave the same note).

If we had made this experiment with two people A and B, and A had applied the expression "the same note" to the octave only, B to the dominant and octave, should we have a right to say that the two hear different things when we play to them the diatonic scale?-If we say they do, let us be dear whether we wish to assert that there must

be some other difference between the two cases besides the one we have observed, or whether we wish to make no such statement.

Page 141

5. All the questions considered here link up with this problem: Suppose you had taught someone to write down series of numbers according to rules of the form: Always write down a number n greater than the preceding. (This rule is abbreviated to "Add n ".) The numerals in this game are to be groups of dashes |, ||, |||, etc. What I call teaching this game, of course, consisted in giving general explanations and doing examples.--These examples are taken from the range, say, between 1 and 85. We now give the pupil the order "Add 1". After some time we observe that after passing 100 he did what we should call adding 2; after passing 300 he does what we should call adding 3. We have him up for this: "Didn't I tell you always to add 1? Look what you have done before you got to 100!"--Suppose the pupil said, pointing to the numbers 102, 104, etc., "Well, didn't I do the same here? I thought this was what you wanted me to do."--You see that it would get us no further here again to say "But don't you see...?", pointing out to him again the rules and examples we had given to him. We might, in such a case, say that this person naturally understands (interprets) the rule (and examples) we have given as we should understand the rule (and examples) telling us: "Add 1 up to 100, then 2 up to 200, etc."

Page 141

(This would be similar to the case of a man who did not naturally follow an order given by a pointing gesture by moving in the direction shoulder to hand, but in the opposite direction. And understanding here means the same as reacting.)

Page 141

I suppose what you say comes to this, that in order to follow the rule "Add 1" correctly a new insight, intuition, is needed at every step.--

Page Break 142

But what does it mean to follow the rule *correctly*? How and when is it to be decided which at a particular point is the correct step to take? The correct step at every point is that which is in accordance with the rule as it was *meant*, intended.--I suppose the idea is this: When you gave the rule "Add 1" and meant it, you meant him to write 101 after 100, 199 after 198, 1041 after 1040, and so on. But how did you do all these acts of meaning (I suppose an infinite number of them) when you gave him the rule? Or is this misrepresenting it? And would you say that there was only one act of meaning, from which, however, all these others, or any one of them, followed in turn? But isn't the point just: 'What does follow from the general rule?' You might say "Surely I knew when I gave him the rule that I meant him to follow up 100 by 101". But here you are misled by the grammar of the word "to know". Was knowing this some mental act by which you at the time made the transition from 100 to 101, i.e., some act like saying to yourself "I want him to write 101 after 100"? In this case ask yourself how many such acts you performed when you gave him the rule. Or do you mean by knowing some kind of disposition?--then only experience can teach us what it was a disposition for. But surely if one had asked me which number he should write after 1568, I should have answered "1569".--I dare say you would, but how can you be sure of it? Your idea really is that somehow in the mysterious act of *meaning* the rule you made the transitions without really making them. You crossed all the bridges before you were there.--This queer idea is connected with a peculiar use of the word "to mean". Suppose our man got to the number 100 and followed it up by 102. We should then say "I *meant* you to write 101". Now the past tense in the word "to mean" suggests that a particular act of meaning had been performed when the rule was given, though as a matter of fact this expression alludes to no such act. The past tense could be explained by putting the sentence into the form "Had you asked me before what I wanted you to do at this stage, I should have said...". But it is a hypothesis that you would have said that.

Page 142

To get this clearer, think of this example: Someone says "Napoleon was crowned in 1804". I ask him "Did you mean the man who won the battle of Austerlitz?" He says "Yes, I meant him".--Does this mean that when he 'meant him', he in some way thought of Napoleon's winning the battle of Austerlitz?

Page 142

The expression "The rule meant him to follow up 100 by 101" makes it appear that this rule, as it was meant, *foreshadowed* all the

Page Break 143

transitions which were to be made according to it. But the assumption of a shadow of a transition does not get us any further, because it does not bridge the gulf between it and the real transition. If the mere words of the rule could not anticipate a future transition, no more could any mental act accompanying these words.

Page 143

We meet again and again with this curious superstition, as one might be inclined to call it, that the mental act is capable of crossing a bridge before we've got to it. This trouble crops up whenever we try to think about the ideas of thinking, wishing, expecting, believing, knowing, trying to solve a mathematical problem, mathematical induction, and so forth.

Page 143

It is no act of insight, intuition, which makes us use the rule as we do at the particular point of the series. It would be less confusing to call it an act of decision, though this too is misleading, for nothing like an act of decision must take place, but possibly just an act of writing or speaking. And the mistake which we here and in a thousand similar cases are inclined to make is labelled by the word "to make" as we have used it in the sentence "It is no act of insight which makes us use the rule as we do", because there is an idea that 'something must make us' do what we do. And this again joins on to the confusion between cause and reason. *We need have no reason to follow the rule as we do.* The chain of reasons has an end.

Page 143

Now compare these sentences: "Surely it is using the rule 'Add 1' in a different way if after 100 you go on to 102, 104, etc." and "Surely it is using the word 'darker' in a different way if after applying it to coloured patches we apply it to the vowels".--I should say: "That depends on what you call a 'different way'".--

Page 143

But I should certainly say that *I should* call the application of "lighter" and "darker" to vowels 'another usage of the words'; and I also should carry on the series 'Add 1' in the way 101, 102, etc., but not--or not necessarily--because of some other justifying mental act.

Page 143

6. There is a kind of general disease of thinking which always looks for (and finds) what would be called a mental state from which all our acts spring as from a reservoir. Thus one says, "The fashion changes because the taste of people changes". The taste is the mental reservoir. But if a tailor to-day designs a cut of dress different from that which he designed a year ago, can't what is called his change of taste have consisted, partly or wholly, in doing just this?

Page 143

And here we say "But surely designing a new shape isn't in itself

Page Break 144

changing one's taste,--and saying a word isn't meaning it,--and saying that I believe isn't believing; there must be feelings, mental acts, going along with these lines and these words".--And the reason we give for saying this is that a man certainly could design a new shape without having changed his taste, say that he believes something without believing it, etc. And this obviously is true. But it doesn't follow that what distinguishes a case of having changed one's taste from a case of not having done so isn't under certain circumstances just designing what one hasn't designed before. Nor does it follow that in cases in which designing a new shape is not the criterion for a change of taste, the criterion must be a change in some particular region of our mind.

Page 144

That is to say, we don't use the word "taste" as the name of a feeling. To think that we do is to represent the practice of our language in undue simplification. This, of course, is the way in which philosophical puzzles generally arise; and our case is quite analogous to that of thinking that wherever we make a predicative statement we state that the subject has a certain ingredient (as we really do in the case, "Beer is alcoholic").

Page 144

It is advantageous in treating our problem to consider parallel with the feeling or feelings characteristic for having a certain taste, changing one's taste, meaning what one says, etc., etc., the facial expression (gestures or tone of voice) characteristic for the same states or events. If someone should object, saying that feelings and facial expressions can't be compared, as the former are experiences and the latter aren't, let him consider the muscular, kinaesthetic and tactile experiences bound up with gestures and facial expressions.

Page 144

7. Let us then consider the proposition "Believing something cannot merely consist in saying that you believe it, you must say it with a particular facial expression, gesture, and tone of voice". Now it cannot be doubted that we regard certain facial expressions, gestures, etc. as characteristic for the expression of belief. We speak of a 'tone of conviction'. And yet it is clear that this tone of conviction isn't always present whenever we rightly speak of conviction. "Just so", you might say, "this shows that there is something else, something behind these gestures, etc. which is the real belief as opposed to mere expressions of belief".--"Not at all", I should say, "many different criteria distinguish, under different circumstances, cases of believing what you say from those of not believing what you say". There may be

cases where the presence of a sensation other than those bound up with gestures, tone of voice, etc. distinguishes meaning what you say from not meaning it. But sometimes what distinguishes these two is nothing that happens while we speak, but a variety of actions and experiences of different kinds before and after.

To understand this family of cases it will again be helpful to consider an analogous case drawn from facial expressions. There is a family of friendly facial expressions. Suppose we had asked "What feature is it that characterizes a friendly face?" At first one might think that there are certain traits which one might call friendly traits, each of which makes the face look friendly to a certain degree, and which when present in a large number constitute the friendly expression. This idea would seem to be borne out by our common speech, talking of 'friendly eyes', 'friendly mouth', etc. But it is easy to see that the same eyes of which we say they make a face look friendly do not look friendly, or even look unfriendly, with certain other wrinkles of the forehead, lines round the mouth, etc. Why then do we ever say that it is these eyes which look friendly? Isn't it wrong to say that they characterize the face as friendly, for if we say they do so 'under certain circumstances' (these circumstances being the other features of the face) why did we single out the one feature from amongst the others? The answer is that in the wide family of friendly faces there is what one might call a main branch characterized by a certain kind of eyes, another by a certain kind of mouth, etc.; although in the large family of unfriendly faces we meet these same eyes when they don't mitigate the unfriendliness of the expression.--There is further the fact that when we notice the friendly expression of a face, our attention, our gaze, is drawn to a particular feature in the face, the 'friendly eyes', or the 'friendly mouth', etc., and that it does not rest on other features although these too are responsible for the friendly expression.

'But is there no difference between saying something and meaning it, and saying it without meaning it?'--There needn't be a difference while he says it, and if there is, this difference may be of all sorts of different kinds according to the surrounding circumstances. It does not follow from the fact that there is what we call a friendly and an unfriendly expression of the eye that there must be a difference between the eye of a friendly and the eye of an unfriendly face.

One might be tempted to say "This trait can't be said to make the face look friendly, as it may be belied by another trait". And this is like saying "Saying something with the tone of conviction can't be the

characteristic of conviction, as it may be belied by experiences going along with it". But neither of these sentences is correct. It is true that other traits in this face could take away the friendly character of this eye, and yet in this face it is the eye which is the outstanding friendly feature.

It is such phrases as "He said it and meant it" which are most liable to mislead us.--Compare meaning "I shall be delighted to see you" with meaning "The train leaves at 3.30". Suppose you had said the first sentence to someone and were asked afterwards "Did you mean it?", you would then probably think of the feelings, the experiences, which you had while you said it. And accordingly you would in this case be inclined to say "Didn't you see that I meant it?" Suppose that on the other hand, after having given someone the information "The train leaves at 3.30", he asked you "Did you mean it?", you might be inclined to answer "Certainly. Why shouldn't I have meant it?"

In the first case we shall be inclined to speak about a feeling characteristic of meaning what we said, but not in the second. Compare also lying in both these cases. In the first case we should be inclined to say that lying consisted in saying what we did but without the appropriate feelings or even with the opposite feelings. If we lied in giving the information about the train, we would be likely to have different experiences while we gave it than those which we have in giving truthful information, but the difference here would not consist in the absence of a characteristic feeling, but perhaps just in the presence of a feeling of discomfort.

It is even possible while lying to have quite strong experience of what might be called the characteristic for meaning what one says--and yet under certain circumstances, and perhaps under the ordinary circumstances, one refers to just this experience in saying, "I meant what I said", because the cases in which something might give the lie to these experiences do not come into the question. In many cases therefore we are inclined to say: "Meaning what I say" means having such and such experiences while I say it.

If by "believing" we mean an activity, a process, taking place while we say that we believe, we may say that believing is something similar to or the same as expressing a belief.

Page 146

8. It is interesting to consider an objection to this: What if I said "I believe it will rain" (meaning what I say) and someone wanted to

Page Break 147

explain to a Frenchman who doesn't understand English what it was I believed. Then, you might say, if all that happened when I believed what I did was that I said the sentence, the Frenchman ought to know what I believe if you tell him the exact words I used, or say "Il croit 'It will rain' ". Now it is clear that this will not tell him what I believe and consequently, you might say, we failed to convey just that to him which was essential, my real mental act of believing.--But the answer is that even if my words had been accompanied by all sorts of experiences, and if we could have transmitted these experiences to the Frenchman, he would still not have known what I believed. For "knowing what I believe" just doesn't mean: feeling what I do while I say it; just as knowing what I intend with this move in our game of chess doesn't mean knowing my exact state of mind while I'm making the move. Though, at the same time, in certain cases, knowing this state of mind might furnish you with very exact information about my intention.

Page 147

We should say that we had told the Frenchman what I believed if we translated my words for him into French. And it *might* be that thereby we told him nothing--even indirectly--about what happened 'in me' when I uttered my belief. Rather, we pointed out to him a sentence which in his language holds a similar position to my sentence in the English language.--Again one might say that, at least in certain cases, we could have told him much more exactly what I believed if he had been at home in the English language, because then, he would have known exactly what happened within me when I spoke.

Page 147

We use the words "meaning", "believing", "intending" in such a way that they refer to certain acts, states of mind given certain circumstances; as by the expression "checkmating somebody" we refer to the act of taking his king. If on the other hand, someone, say a child, playing about with chessmen, placed a few of them on a chess board and went through the motions of taking a king, we should not say the child had checkmated anyone.--And here, too, one might think that what distinguished this case from real checkmating was what happened in the child's mind.

Page 147

Suppose I had made a move in chess and someone asked me "Did you intend to mate him?", I answer "I did", and he now asks me "How could you know you did, as all you *knew* was what happened within you when you made the move?", I might answer "Under *these* circumstances this was intending to mate him".

Page Break 148

Page 148

9. What holds for 'meaning' holds for 'thinking'.--We very often find it impossible to think without speaking to ourselves half aloud,--and nobody asked to describe what happened in this case would ever say that something--the thinking--accompanied the speaking, were he not led into doing so by the pair of verbs "speaking"/"thinking", and by many of our common phrases in which their uses run parallel. Consider these examples: "Think before you speak!" "He speaks without thinking", "What I said didn't quite express my thought", "He says one thing and thinks just the opposite", "I didn't mean a word of what I said", "The French language uses its words in that order in which we think them".

Page 148

If anything in such a case can be said to go with the speaking, it would be something like the modulation of voice, the changes in timbre, accentuation, and the like, all of which one might call means of expressiveness. Some of these, like the tone of voice and the accent, nobody for obvious reasons would call the accompaniments of the speech; and such means of expressiveness as the play of facial expression or gestures which can be said to accompany speech, nobody would dream of calling thinking.

Page 148

10. Let us revert to our example of the use of "lighter" and "darker" for coloured objects and the vowels. A reason which we should like to give for saying that here we have two different uses and not one is this: 'We don't think that the words "darker", "lighter" actually fit the relation between the vowels, we only feel a resemblance between the relation of the sounds and the darker and lighter colours'. Now if you wish to see what sort of feeling this is, try to imagine that without previous introduction you asked someone "Say the vowels a, e, i, o, u, in the order

of their darkness". If I did this, I should certainly say it in a different tone from that in which I should say "Arrange these books in the order of their darkness"; that is, I should say it haltingly, in a tone similar to that of "I wonder if you understand me", perhaps smiling slyly as I say it. And this, if anything, describes my *feeling*. And this brings me to the following point: When someone asks me "What colour is the book over there?", and I say "Red", and then he asks "What made you call this colour 'red'?", I shall in most cases have to say: "Nothing *makes* me call it red; that is, *no reason*. I just looked at it and said 'It's red'". One is then inclined to say: "Surely this isn't all that happened; for I could look at a colour and say a

Page Break 149

word and still not name the colour". And then one is inclined to go on to say: "The word 'red' when we pronounce it, naming the colour we look at, *comes in a particular way*". But, at the same time, asked "Can you describe the way you mean?"--one wouldn't feel prepared to give any description. Suppose now we asked: "Do you, at any rate, remember that the name of the colour came to you *in that particular way* whenever you named colours on former occasions?"--he would have to admit that he didn't remember a particular way in which this always happened. In fact one could easily make him see that naming a colour could go along with all sorts of different experiences. Compare such cases as these: *a*) I put an iron in the fire to heat it to light red heat. I am asking you to watch the iron and want you to tell me from time to time what stage of *heat* it has reached. You look and say: "It is beginning to get light red". *b*) We stand at a street crossing and I say: "Watch out for the green light. When it comes on, tell me and I'll run across." Ask yourself this question: If in one such case you shout "Green!" and in another "Run!", do these words come in the same way or in different ways? Can one say anything about this in a general way? *c*) I ask you: "What's the colour of the bit of material you have in your hand?" (and I can't see). You think: "Now what does one call this? Is this 'Prussian blue' or 'indigo'?"

Page 149

Now it is very remarkable that when in a philosophical conversation we say: "The name of a colour comes in a particular way", we don't trouble to think of the many different cases and ways in which such a name comes.--And our chief argument is really that naming the colour is different from just pronouncing a word on some different occasion while looking at a colour. Thus one might say: "Suppose we counted some objects lying on our table, a blue one, a red one, a white one, and a black one,--looking at each in turn we say: 'One, two, three, four'. Isn't it easy to see that something different happens in this case when we pronounce the words than what would happen if we had to tell someone the colours of the objects? And couldn't we, with the same right as before, have said 'Nothing else happens when we say the numerals than just saying them while looking at the objects'? "Now two answers can be given to this: First, undoubtedly, at least in the great majority of cases, counting the objects will be accompanied by different experiences from naming their colours. And it is easy to describe roughly what the difference will be. In counting we know a certain gesture, as it were, beating the number out with one's finger or by nodding one's head. There is, on the other hand, an

Page Break 150

experience which one might call "concentrating one's attention on the colour", getting the full impression of it. And these are the sort of things one recalls when one says "It is easy to see that something different happens when we count the objects and when we name their colours". But it is in no way necessary that certain peculiar experiences more or less characteristic for counting take place while we are counting, nor that the peculiar phenomenon of gazing at the colour takes place when we look at the object and name its colour. It is true that the processes of counting four objects and of naming their colours will, in most cases at any rate, be different taken as a whole, and *this* is what strikes us; but that doesn't mean at all that we know that something different happens every time in these two cases when we pronounce a numeral on the one hand and a name of a colour on the other.

Page 150

When we philosophize about this sort of thing we almost invariably do something of this sort: We repeat to ourselves a certain experience, say, by looking fixedly at a certain object and trying to 'read off' as it were the name of its colour. And it is quite natural that doing so again and again we should be inclined to say, "Something particular happens while we say the word 'blue'". For we are aware of going again and again through the same process. But ask yourself: Is this also the process which we usually go through when on various occasions--not philosophizing--we name the colour of an object?

Page 150

11. The problem which we are concerned with we also encounter in thinking about volition, deliberate and involuntary action. Think, say, of these examples: I deliberate whether to lift a certain heavyish weight, decide to do it, I then apply my force to it and lift it. Here, you might say, you have a full-fledged case of willing and intentional action. Compare with this such a case as reaching a man a lighted match after having lit with it one's own cigarette

and seeing that he wishes to light his; or again the case of moving your hand while writing a letter, or moving your mouth, larynx, etc. while speaking.--Now when I called the first example a full-fledged case of willing, I deliberately used this misleading expression. For this expression indicates that one is inclined in thinking about volition to regard this sort of example as one exhibiting most clearly the typical characteristic of willing. One takes one's ideas, and one's language, about volition from this kind of example and thinks that they must apply--if not in such an obvious way-to all cases which one can properly call cases of willing.-It is the same case that we have met over and over again:

Page Break 151

The forms of expression of our ordinary language fit most obviously certain very special applications of the words "willing", "thinking", "meaning", "reading", etc., etc. And thus we might have called the case in which a man 'first thinks and then speaks' the full-fledged case of thinking and the case in which a man spells out the words he is reading the full-fledged case of reading. We speak of an 'act of volition' as different from the action which is willed, and in our first example there are lots of different acts clearly distinguishing this case from one in which all that happens is that the hand and the weight lift: there are the preparations of deliberation and decision, there is the effort of lifting. But where do we find the analogues to these processes in our other examples and in innumerable ones we might have given?

Page 151

Now on the other hand it has been said that when a man, say, gets out of bed in the morning, all that happens may be this: he deliberates, "Is it time to get up?", he tries to make up his mind, and then suddenly *he finds himself getting up*. Describing it this way emphasizes the absence of an act of volition. Now first: where do we find the prototype of such a thing, i.e., how did we come by the idea of such an act? I think the prototype of the act of volition is the experience of muscular effort.--Now there is something in the above description which tempts us to contradict it; we say: "We don't just 'find', observe, ourselves getting up, as though we were observing someone else! It isn't like, say, watching certain reflex actions. If, e.g., I place myself sideways close to a wall, my wall-side arm hanging down outstretched, the back of the hand touching the wall, and if now keeping the arm rigid I press the back of the hand hard against the wall, doing it all by means of the deltoid muscle, if then I quickly step away from the wall, letting my arm hang down loosely, my arm without any action of mine, of its own accord begins to rise; this is the sort of case in which it would be proper to say, 'I *find* my arm rising'."

Page 151

Now here again it is clear that there are many striking differences between the case of observing my arm rising in this experiment or watching someone else getting out of bed and the case of finding myself getting up. There is, e.g., in this case a perfect absence of what one might call surprise, also I don't *look* at my own movements as I might look at someone turning about in bed, e.g., saying to myself "Is he going to get up?" There is a difference between the voluntary act of getting out of bed and the involuntary rising of my arm. But there is not one common difference between so-called

Page Break 152

voluntary acts and involuntary ones, viz, the presence or absence of one element, the 'act of volition'.

Page 152

The description of getting up in which a man says "I just find myself getting up" suggests that he wishes to say that he *observes* himself getting up. And we may certainly say that an attitude of observing is absent in this case. But the observing attitude again is not one continuous state of mind or otherwise which we are in the whole time while, as we should say, we are observing. Rather, there is a family of groups of activities and experiences which we call observing attitudes. Roughly speaking one might say there are observation-elements of curiosity, observant expectation, surprise, and there are, we should say, facial expressions and gestures of curiosity, of observant expectation, and of surprise; and if you agree that there is more than one facial expression characteristic for each of these cases, and that there can be these cases without any characteristic facial expression, you will admit that to each of these three words a *family* of phenomena corresponds.

Page 152

12. If I had said "When I told him that the train was leaving at 3.30, believing that it did, nothing happened than that I just uttered the sentence", and if someone contradicted me, saying "Surely this couldn't have been all, as you might 'just say a sentence' without believing it",--my answer should be "I didn't wish to say that there was no difference between speaking, believing what you say, and speaking, not believing what you say; but the pair 'believing'/not believing' refers to various differences in different cases (differences forming a family), not to one difference, that between the presence and the absence of a certain mental state."

Page 152

13. Let us consider various characteristics of voluntary and involuntary acts. In the case of lifting the heavy weight, the various experiences of effort are obviously most characteristic for lifting the weight voluntarily. On the other hand, compare with this the case of writing, voluntarily, where in most of the ordinary cases there will be no effort; and even if we feel that the writing tires our hands and strains their muscles, this is not the experience of 'pulling' and 'pushing' which we would call typical voluntary actions. Further compare the lifting of your hand when you lift a weight with it with lifting your hand when, e.g., you point to some object above you. This will certainly be regarded as a voluntary act, though the element of effort will most likely be entirely absent; in fact this raising of the arm

Page Break 153

to point at an object is very much like raising the eye to look at it, and here we can hardly conceive of an effort.--Now let us describe an act of involuntarily raising your arm. There is the case of our experiment, and this was characterized by the utter absence of muscular strain and also by our observant attitude towards the lifting of the arm. But we have just seen a case in which muscular strain was absent, and there are cases in which we should call an action voluntary although we take an observant attitude towards it. But in a large class of cases it is the peculiar impossibility of taking an observant attitude towards a certain action which characterizes it as a- voluntary one. Try, e.g., to observe your hand rising when you voluntarily raise it. Of course you *see* it rising as you do, say, in the experiment; but you can't somehow follow it in the same way with your eye. This might get clearer if you compare two different cases of following lines on a piece of paper with your eye; a) some irregular line like this:



b) a written sentence. You will find that in a) the eye, as it were, alternately slips and gets stuck, whereas in reading a sentence it glides along smoothly.

Page 153

Now consider a case in which we do take up an observant attitude towards a voluntary action, I mean the very instructive case of trying to draw a square with its diagonals by placing a mirror on your drawing paper and directing your hand by what you see by looking at it in the mirror. And here one is inclined to say that our real *actions*, the ones to which volition *immediately* applies, are not the movements of our hand but something further back, say, the actions of our muscles. We are inclined to compare the case with this: Imagine we had a series of levers before us, through which, by a hidden mechanism, we could direct a pencil drawing on a sheet of paper. We might then be in doubt which levers to pull in order to get the desired movement of the pencil; and we could say that *we deliberately* pulled this particular lever, although we didn't deliberately produce the wrong result that we thereby produced. But this comparison, though it easily suggests itself, is very misleading. For in the case of the levers which we saw before us, there was such a thing as deciding which one we were going to pull before pulling it. But does our volition, as it were, play on a keyboard of muscles, choosing which one it was going to use next?--For some actions which we call deliberate it is characteristic

Page Break 154

that we, in some sense, 'know what we are going to do' before we do it. In this sense we say that we know what object we are going to point to, and what we might call 'the act of knowing' might consist in looking at the object before we point to it or in describing its position by words or pictures. Now we could describe our drawing the square through the mirror by saying that our acts were deliberate as far as their motor aspect is concerned, but not as far as their visual aspect is concerned. This would, e.g., be demonstrated by our ability to repeat a movement of the hand which had produced a wrong result, on being told to do so. But it would obviously be absurd to say that this motor character of voluntary motion consisted in our knowing beforehand what we were going to do, as though we had had a picture of the kinaesthetic sensation before our mind and decided to bring about this sensation. Remember the experiment where the subject has his fingers intertwined; if here, instead of pointing from a distance to the finger which you order him to move, you touch that finger, he will always move it without the slightest difficulty. And here it is tempting to say "Of course I can move it now, because now I know which finger it is I'm asked to move." This makes it appear as though I had now shown you which muscle to contract in order to bring about the desired result. The word "of course" makes it appear as though by touching your finger I had given you an item of information telling you what to do. (As though normally when you tell a man to move such and such a finger he could follow your order because he knew how to bring the movement about.)

Page 154

(It is interesting here to think of the case of sucking a liquid through a tube; if asked what part of your body you sucked with, you would be inclined to say your mouth, although the work was done by the muscles by which you draw your breath.)

Page 154

Let us now ask ourselves what we should call "speaking involuntarily". First note that when normally you speak, voluntarily, you could hardly describe what happened by saying that by an act of volition you move your mouth, tongue, larynx, etc. as a means to producing certain sounds. Whatever happens in your mouth, larynx, etc. and whatever sensations you have in these parts while speaking would almost seem secondary phenomena accompanying the production of sounds, and volition, one wishes to say, operates on the sounds themselves without intermediary mechanism. This shows how loose our idea of this agent 'volition' is.

Page 154

Now to involuntary speaking. Imagine you had to describe a

Page Break 155

case,--what would you do? There is of course the case of speaking in one's sleep; this is characterized by our doing it without being aware of it and not remembering having done it. But this obviously you wouldn't call the characteristic of an involuntary action.

Page 155

A better example of involuntary speaking would, I suppose, be that of involuntary exclamations: "Oh!", "Help!", and such like, and these utterances are akin to shrieking with pain. (This, by the way, could set us thinking about 'words as expressions of feelings'.) One might say: "Surely these are good examples of involuntary speech, because there is in these cases not only no act of volition by which we speak, but in many cases we utter these words *against* our will". I should say: I certainly should call this involuntary speaking; and I agree that an act of volition preparatory to or accompanying these words is absent,--if by "act of volition" you refer to certain acts of intention, premeditation, or effort. But then in many cases of voluntary speech I don't feel an effort, much that I say voluntarily is not premeditated, and I don't know of any acts of intention preceding it.

Page 155

Crying out with pain against our will could be compared with raising our arm against our will when someone forces it up while we are struggling against him. But it is important to notice that the will--or should we say 'wish'--not to cry out is overcome in a different way from that in which our resistance is overcome by the strength of the opponent. When we cry out against our will, we are as it were taken by surprise; as though someone forced up our hands by unexpectedly sticking a gun into our ribs, commanding "Hands up!"

Page 155

14. Consider now the following example, which is of great help in all these considerations: In order to see what happens when one understands a word, we play this game: You have a list of words, partly these words are words of my native language, partly words of foreign languages more or less familiar to me, partly words of languages entirely unknown to me (or, which comes to the same, nonsensical words invented for the occasion). Some of the words of my native tongue, again, are words of ordinary everyday usage: and some of these, like "house", "table", "man", are what we might call primitive words, being among the first words a child learns, and some of these again, words of baby talk like "Mamma", "Papa". Again, there are more or less common technical terms such as "carburettor", "dynamo", "fuse"; etc., etc. All these words are read out

Page Break 156

to me, and after each one I have to say "Yes" or "No" according to whether I understand the word or not. I then try to remember what happened in my mind when I understood the words I did understand, and when I didn't understand the others. And here again it will be useful to consider the particular tone of voice and facial expression with which I say "Yes" and "No", alongside of the so-called mental events.--Now it may surprise us to find that although this experiment will show us a multitude of different characteristic experiences, it will not show us any one experience which we should be inclined to call the experience of understanding. There will be such experiences as these: I hear the word "tree" and say "Yes" with the tone of voice and sensation of "Of course". Or I hear "corroboration" I say to myself, "Let me see", vaguely remember a case of helping, and say "Yes". I hear "gadget", I imagine the man who always used this word, and say "Yes". I hear "Mamma", this strikes me as funny and childish--"Yes". A foreign word I shall very often translate in my mind into English before answering. I hear "spintharoscope", and say to myself, "Must be some sort of scientific instrument", perhaps try to think up its meaning from its derivation and fail, and say "No". In another case I might say to myself, "Sounds like Chinese"--"No". Etc. There will, on the other hand, be a large class of cases in which I am not aware of anything happening except hearing the word and saying the answer. And there will also be cases in which I remember

experiences (sensations, thoughts) which, as I should say, had nothing to do with the word at all. Thus amongst the experiences which I can describe there will be a class which I might call typical experiences of understanding and some typical experiences of not understanding. But opposed to these there will be a large class of cases in which I should have to say "I know of no particular experience at all, I just said 'Yes', or 'No'".

Page 156

Now if someone said "But surely something did happen when you understood the word 'tree', unless you were utterly absentminded when you said 'Yes'", I might be inclined to reflect and say to myself, "Didn't I have a sort of homely feeling when I took in the word 'tree'?" But then, do I always have this feeling which now I referred to when I hear that word used or use it myself, do I remember having had it, do I even remember a set of, say, five sensations some one of which I had on every occasion when I could be said to have understood the word? Further, isn't that 'homely feeling' I referred

Page Break 157

to an experience rather characteristic for the particular situation I'm in at present, i.e., that of philosophizing about 'understanding'?

Page 157

Of course in our experiment we might call saying "Yes" or "No" characteristic experiences of understanding or not understanding, but what if we just hear a word in a sentence, where there isn't even a question of this reaction to it?--We are here in a curious difficulty: on the one hand it seems we have no reason to say that in all cases in which we understand a word one particular experience--or even one of a set--is present. On the other hand we may feel it's plainly wrong to say that in such a case all that happens may be that I hear or say the word. For that seems to be saying that part of the time we act as mere automatons. And the answer is that in a sense we do and in a sense we don't.

Page 157

If someone talked to me with a kindly play of facial expressions, is it necessary that in any short interval his face should have looked such that seeing it under any other circumstances I should have called its expression distinctly kindly? And if not, does this mean that his 'kindly play of expression' was interrupted by periods of inexpressiveness?--We certainly should not say this under the circumstances which I am assuming, and we don't feel that the look at this moment interrupts the expressiveness, although taken alone we should call it inexpressive.

Page 157

Just in this way we refer by the phrase "understanding a word" not necessarily to that which happens while we are saying or hearing it, but to the whole environment of the event of saying it. And this also applies to our saying that someone speaks like an automaton or like a parrot. Speaking with understanding certainly differs from speaking like an automaton, but this doesn't mean that the speaking in the first case is all the time accompanied by something which is lacking in the second case. Just as when we say that two people move in different circles this doesn't mean that they mayn't walk the street in identical surroundings.

Page 157

Thus also, acting voluntarily (or involuntarily) is, in many cases, characterized as such by a multitude of circumstances under which the action takes place rather than by an experience which we should call characteristic of voluntary action. And in this sense it is true to say that what happened when I got out of bed--when I should certainly not call it involuntary--was that I found myself getting up. Or rather, this is a possible case; for of course every day something different happens.

Page Break 158

Page 158

15. The troubles which we have been turning over since §7 were all closely connected with the use of the word "particular". We have been inclined to say that seeing familiar objects we have a particular feeling, that the word "red" came in a particular way when we recognized the colour as red, that we had a particular experience when we acted voluntarily.

Page 158

Now the use of the word "particular" is apt to produce a kind of delusion and roughly speaking this delusion is produced by the double usage of this word. On the one hand, we may say, it is used preliminary to a specification, description, comparison; on the other hand, as what one might describe as an emphasis. The first usage I shall call the transitive one, the second the intransitive one. Thus, on the one hand I say "This face gives me a particular impression which I can't describe". The latter sentence may mean something like: "This face gives me a strong impression". These examples would perhaps be more striking if we substituted the word "peculiar" for "particular", for the same comments apply to "peculiar". If I say "This soap has a *peculiar* smell: it is the kind we used as

children", the word "peculiar" may be used merely as an introduction to the comparison which follows it, as though I said "I'll tell you what this soap smells like:...". If, on the other hand, I say "This soap has a peculiar smell!" or "It has a most peculiar smell", "peculiar" here stands for some such expression as "out of the ordinary", "uncommon", "striking".

Page 158

We might ask "Did you say it had a peculiar smell, as opposed to no peculiar smell, or that it had this smell, as opposed to some other smell, or did you wish to say both the first and the second?"-Now what was it like when, philosophizing, I said that the word "red" came in a particular way when I described something I saw as red? Was it that I was going to describe the way in which the word "red" came, like saying "It always comes quicker than the word 'two' when I'm counting coloured objects", or "It always comes with a shock", etc.?--Or was it that I wished to say that "red" comes in a striking way?--Not exactly that either. But certainly rather the second than the first. To see this more dearly, consider another example: You are, of course, constantly changing the position of your body throughout the day; arrest yourself in any such attitude (while writing, reading, talking, etc., etc.) and say to yourself in the way in which you say "Red' comes in a particular way...", "I am now in a particular attitude". You will find that you can quite naturally say

Page Break 159

this. But aren't you always in a particular attitude? And of course you didn't mean that you were just then in a particularly striking attitude. What was it that happened? You concentrated on, as it were stared at, your sensations. And this is exactly what you did when you said that "red" came in a particular way.

Page 159

"But didn't I mean that 'red' came in a different way from 'two'?"--You may have meant this, but the phrase, "They come in different ways", is itself liable to cause confusion. Suppose I said "Smith and Jones always enter my room in different ways": I might go on and say "Smith enters quickly, Jones slowly", I am specifying the ways. I might on the other hand say "I don't know what the difference is", intimating that I'm *trying* to specify the difference, and perhaps later on I shall say "Now I know what it is; it is...".--I could on the other hand tell you that they came in different ways, and you wouldn't know what to make of this statement, and perhaps answer "Of course they come in different ways; they just *are* different".--We could describe our trouble by saying that we feel as though we could give an experience a name without at the same time committing ourselves about its use, and in fact without any intention to use it at all. Thus when I say "red" comes in a particular way..., I feel that I might now give this way a name if it hasn't already got one, say "A". But at the same time I am not at all prepared to say that I recognize this to be the way "red" has always come on such occasions, nor even to say that there are, say, four ways, A, B, C, D, in one of which it always comes. You might say that the two ways in which "red" and "two" come can be identified by, say, exchanging the meaning of the two words, using "red" as the second cardinal numeral, "two" as the name of a colour. Thus, on being asked how many eyes I had, I should answer "red", and to the question "What is the colour of blood?", "two". But the question now arises whether you can identify the 'way in which these words come' independently of the ways in which they are used,--I mean the ways just described. Did you wish to say that as a matter of experience, the word when used in *this* way always comes in the way A, but may, the next time, come in the way "two" usually comes? You will see then that you meant nothing of the sort.

Page 159

What is *particular* about the way "red" comes is that it comes while you're philosophizing about it, as what is particular about the position of your body when you concentrated on it was concentration. We appear to ourselves to be on the verge of describing the way, whereas we aren't really opposing it to any other way. We are emphasizing,

Page Break 160

not comparing, but we express ourselves as though this emphasis was really a comparison of the object with itself; there seems to be a reflexive comparison. Let me explain myself in this way: suppose I speak of the way in which A enters the room, I may say "I have noticed the way in which A enters the room", and on being asked "What is it?", I may answer "He always sticks his head into the room before coming in". Here I'm referring to a definite feature, and I could say that B had the same way, or that A no longer had it. Consider on the other hand the statement "I've now been observing the way A sits and smokes". I want to draw him like this. In this case I needn't be ready to give any description of a particular feature of his attitude, and my statement may just mean "I've been observing A as he sat and smoked".--'The way' can't in this case be separated from him. Now if I wished to draw him as he sat there, and was contemplating, studying, his attitude, I should while doing so be inclined to say and repeat to myself "He has a particular way of sitting". But the answer to the question "What way?" would be "Well, *this* way", and perhaps one would give it by drawing the characteristic outlines of his attitude. On the other hand, my phrase "He has a particular

way...", might just have to be translated into "I'm contemplating his attitude". Putting it in this form we have, as it were, straightened out the proposition; whereas in its first form its meaning seems to describe a loop, that is to say, the word "particular" here seems to be used transitively and, more particularly, reflexively, i.e., we are regarding its use as a special case of the transitive use. We are inclined to answer the question "What way do you mean?" by "This way", instead of answering: "I didn't refer to any particular feature; I was just contemplating his position". My expression made it appear as though I was pointing out something *about* his way of sitting, or, in our previous case, about the way the word "red" came, whereas what makes me use the word "particular" here is that by my attitude towards the phenomenon I am laying an emphasis on it: I am concentrating on it, or retracing it in my mind, or drawing it, etc.

Page 160

Now this is a characteristic situation to find ourselves in when thinking about philosophical problems. There are many troubles which arise in this way, that a word has a transitive and an intransitive use, and that we regard the latter as a particular case of the former, explaining the word when it is used intransitively by a reflexive construction.

Page 160

Thus we say, "By 'kilogram' I mean the weight of one litre of water", "By 'A' I mean 'B', where B is an explanation of A".

Page Break 161

But there is also the intransitive use: "I said that I was sick of it and meant it". Here again, meaning what you said could be called "retracing it", "laying an emphasis on it". But using the word "meaning" in this sentence makes it appear that it must have sense to ask "What did you mean?" and to answer "By what I said I meant what I said," treating the case of "I mean what I say" as a special case of "By saying 'A' I mean 'B' ". In fact one uses the expression "I mean what I mean" to say, "I have no explanation for it". The question, "What does this sentence *p* mean?", if it doesn't ask for a translation of *p* into other symbols, has no more sense than "What sentence is formed by this sequence of words?"

Page 161

Suppose to the question, "What's a kilogram?" I answered, "It is what a litre of water weighs", and someone asked, "Well, what does a litre of water weigh?"--

Page 161

We often use the reflexive form of speech as a means of emphasizing something. And in all such cases our reflexive expressions can be 'straightened out'. Thus we use the expression "If I can't, I can't", "I am as I am", "It is just what it is", also "That's that". This latter phrase means as much as "That's settled", but why should we express "That's settled" by "That's that"? The answer can be given by laying before ourselves a series of interpretations which make a transition between the two expressions. Thus for "That's settled", I will say "The matter is closed". And this expression, as it were, files the matter and shelves it. And filing it is like drawing a line around it, as one sometimes draws a line around the results of a calculation, thereby marking it as final. But this also makes it stand out; it is a way of emphasizing it. And what the expression "That's that" does is to emphasize the 'that'.

Page 161

Another expression akin to those we have just considered is this: "Here it is; take it or leave it!" And this again is akin to a kind of introductory statement which we sometimes make before remarking on certain alternatives, as when we say: "It either rains or it doesn't rain; if it rains we'll stay in my room, if it doesn't...". The first part of this sentence is no piece of information (just as "Take it or leave it" is no order). Instead of, "It either rains or it doesn't rain" we could have said, "Consider the two cases...". Our expression underlines these cases, presents them to your attention.

Page 161

It is closely connected with this that in describing a case like $30) \dagger 1$ we are tempted to use the phrase, "There is, *of course*, a number beyond

Page Break 162

which no one of the tribe has ever counted; let this number be...". Straightened out this reads: "Let the number beyond which no one of the tribe has ever counted be...". Why we tend to prefer the first expression to the one straightened out is that it more strongly directs our attention to the upper end of the range of numerals used by our tribe in their actual practice.

Page 162

16. Let us now consider a very instructive case of that use of the word "particular" in which it does not point to a comparison and yet seems most strongly to do so,--the case when we contemplate the expression of a face

primitively drawn in this way:



Page 162

Let this face produce an impression on you. You may then feel inclined to say: "Surely I don't see mere dashes. I see a face with a *particular* expression". But you don't mean that it has an outstanding expression nor is it said as an introduction to a description of the expression, though we might give such a description and say, e.g., "It looks like a complacent business man, stupidly supercilious, who though fat, imagines he's a lady killer". But this would only be meant as an approximate description of the expression. "Words can't exactly describe it", one sometimes says. And yet one feels that what one calls the expression of the face is something that can be detached from the drawing of the face. It is as though we could say: "This face has a particular expression: namely this" (pointing to something). But if I had to point to anything in this place it would have to be the drawing I am looking at. (We are, as it were, under an optical delusion which by some sort of reflection makes us think that there are two objects where there is only one. The delusion is assisted by our using the verb "to have", saying "The face *has* a particular expression". Things look different when, instead of this, we say: "This *is* a peculiar face". What a thing *is*, we mean, is bound up with it; what it has can be separated from it.)

Page 162

'This face has a particular expression.'--I am inclined to say this when I am trying to let it make its full impression upon me.

Page 162

What goes on here is an act, as it were, of digesting it, getting hold of it, and the phrase "getting hold of the expression of this face" suggests that we are getting hold of a thing which is *in* the face and different from it. It seems we are looking for something, but we don't

Page Break 163

do so in the sense of looking for a model of the expression outside the face we see, but in the sense of sounding the thing without attention. It is, when I let the face make an impression on me, as though there existed a double of its expression, as though the double was the prototype of the expression and as though seeing the expression of the face was finding the prototype to which it corresponded--as though in our mind there had been a mould and the picture we see had fallen into that mould, fitting it. But it is rather that we let the picture sink into our mind and make a mould there.

Page 163

When we say, "This is a *face*, and not mere strokes", we are, of course, distinguishing such a drawing



from such a one



And it is true: If you ask anyone: "What is this?" (pointing to the first drawing) he will certainly say: "It's a face", and he will be able straight away to reply to such questions as, "Is it male or female?", "Smiling or sad?", etc. If on the other hand you ask him: "What is this?" (pointing to the second drawing), he will most likely say, "This is nothing at all", or "These are just dashes". Now think of looking for a man in a picture puzzle; there it often happens that what at first sight appears as 'mere dashes' later appears as a face. We say in such cases: "Now I see it is a face". It must be quite clear to you that this doesn't mean that we recognize it as the face of a friend or that we are under the delusion of seeing a 'real' face: rather, this 'seeing it *as a face*' must be compared with seeing this drawing

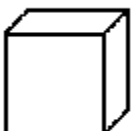

either as a cube or as a plane figure consisting of a square and two rhombuses; or with seeing this



Page Break 164

'as a square with diagonals', or 'as a swastika', that is, as a limiting case of this;



or again with seeing these four dots as two pairs of dots side by side with each other, or as two interlocking pairs, or as one pair inside the other, etc.

Page 164

The case of 'seeing



as a swastika' is of special interest because this expression might mean being, somehow, under the optical delusion that the square is not quite closed, that there are the gaps which distinguish the swastika from our drawing. On the other hand it is quite clear that this was not what we meant by "seeing our drawing as a swastika". We saw it in a way which suggested the description, "I see it as a swastika". One might suggest that we ought to have said "I see it as a closed swastika";--but then, what is the difference between a closed swastika and a square with diagonals? I think that in this case it is easy to recognize 'what happens when we see our figure as a swastika'. I believe it is that we retrace the figure with our eyes in a particular way, viz., by staring at the centre, looking along a radius, and along a side adjacent to it, starting at the centre again, taking the next radius and the next side, say in a right-handed sense of rotation, etc. But this *explanation* of the phenomenon of seeing the figure as a swastika is of no fundamental interest to us. It is of interest to us only in so far as it helps one to see that the expression "seeing the figure as a swastika" did not mean seeing *this* or *that*, seeing one thing as something else, when, essentially, *two* visual objects entered the process of doing so.-Thus also seeing the first figure as a cube did not mean 'taking it to be a cube'. (For we might never have seen a cube and still have this experience of 'seeing it as a cube'.)

Page 164

And in this way 'seeing dashes as a face' does not involve a comparison between a group of dashes and a real human face; and, on the other hand, this form of expression most strongly suggests that we are alluding to a comparison.

Page 164

Consider also this example: Look at W once as a capital double-U,

Page Break 165

and another time as a capital M upside down. Observe what doing the one and doing the other consists in.

Page 165

We distinguish seeing a drawing as a face and seeing it as something else or as 'mere dashes'. And we also distinguish between superficially glancing at a drawing (seeing it as a face), and letting the face make its full impression on us. But it would be queer to say: "I am letting the face make *a particular* impression on me" (except in such cases in which you can say that you can let the same face make different impressions on you). And in letting the face impress itself on me and contemplating its 'particular impression', no two things of the multiplicity of a face are compared with each other; there is only *one* which is laden with emphasis. Absorbing its expression, I don't find a prototype of this expression in my mind; rather, I, as it were, cut a seal from the impression.

Page 165

And this also describes what happens when in 15)†1 we say to ourselves "The word 'red' comes in a particular way...". The reply could be: "I see, you're repeating to yourself some experience and again and again gazing at it."

Page 165

17. We may shed light on all these considerations if we compare what happens when we remember the face of someone who enters our room, when we recognize him as Mr. So and So,--when we compare what really happens in such cases with the representation we are sometimes inclined to make of the events. For here we are often obsessed by a primitive conception, viz., that we are comparing the man we see with a memory image in our mind and we find the two to agree. I.e., we are representing 'recognizing someone' as a process of identification by means of a picture (as a criminal is identified by his photo). I needn't say that in most cases in which we recognize someone no comparison between him and a mental picture takes place. We are, of course, tempted to give this description by the fact that there are memory images. Very often, for instance, such an image comes before our mind immediately *after* having recognized someone. I see him as he stood when we last saw each other ten years ago.

Page 165

I will here again describe the *kind* of thing that happens in your mind and otherwise when you recognize a person coming into your room by means of what you might *say* when you recognize him. Now this may just be: "Hello!" And thus we may say that one kind of event of recognizing a thing we see consists in saying "Hello!" to it in words,

Page Break 166

gestures, facial expressions, etc.--And thus also we may think that when we look at our drawing and see it as a face, we compare it with some paradigm, and it agrees with it, or it fits into a mould ready for it in our mind. But no such mould or comparison enters into our experience, there is only this shape, not any other to compare it with, and as it were, say "Of course" to. As when in putting together a jig-saw puzzle, somewhere a small space is left unfilled and I see a piece obviously fitting it and put it in the place saying to myself "Of course". But here we say, "Of course" *because* the piece fits the mould, whereas in our case of seeing the drawing as a face, we have the same attitude for *no* reason.

Page 166

The same strange illusion which we are under when we seem to seek the something which a face expresses whereas, in reality, we are giving ourselves up to the features before us--that same illusion possesses us even more strongly if repeating a tune to ourselves and letting it make its full impression on us, we say "This tune says *something*", and it is as though I had to find *what* it says. And yet I know that it doesn't say anything such that I might express in words or pictures what it says. And if, recognizing this, I resign myself to saying "It just expresses a musical thought", this would mean no more than saying "It expresses itself".--"But surely when you play it you don't play it *anyhow*, you play it in this particular way, making a crescendo here, a diminuendo there, a caesura in this place, etc."--Precisely, and that's all I can say about it, or may be all that I can say about it. For in certain cases I can justify, explain the particular expression with which I play it by a comparison, as when I say "At this point of the theme, there is, as it were, a colon", or "This is, as it were, the answer to what came before", etc. (This, by the way, shows what a 'justification' and an 'explanation' in aesthetics is like.) It is true I may hear a tune played and say "This is not how it ought to be played, it goes like this"; and I whistle it in a different tempo. Here one is inclined to ask "What is it like to know the tempo in which a piece of music should be played?" And the idea suggests itself that there *must* be a paradigm somewhere in our mind, and that we have adjusted the tempo to conform to that paradigm. But in most cases if someone asked me "How do you think this melody should be played?", I will, as an answer, just whistle it in a particular way, and nothing will have been present to my mind but the tune *actually whistled* (not an image of *that*).

Page 166

This doesn't mean that suddenly understanding a musical theme

Page Break 167

may not consist in finding a form of verbal expression which I conceive as the verbal counterpoint of the theme. And in the same way I may say "Now I understand the expression of this face", and what happened when the understanding came was that I found the word which seemed to sum it up.

Page 167

Consider also this expression: "Tell yourself that it's a *waltz*, and you will play it correctly".

Page 167

What we call "understanding a sentence" has, in many cases, a much greater similarity to understanding a musical theme than we might be inclined to think. But I don't mean that understanding a musical theme is more like the picture which one tends to make oneself of understanding a sentence; but rather that this picture is wrong, and that understanding a sentence is much more like what really happens when we understand a tune than at first sight

appears. For understanding a sentence, we say, points to a reality outside the sentence. Whereas one might say "Understanding a sentence means getting hold of its content; and the content of the sentence is *in* the sentence."

Page 167

18. We may now return to the ideas of 'recognizing' and 'familiarity', and in fact to that example of recognition and familiarity which started our reflections on the use of these terms and of a multitude of terms connected with them. I mean the example of reading, say, a written sentence in a well-known language.--I read such a sentence to see what the experience of reading is like, what 'really happens' when one reads, and I get a particular experience which I take to be the experience of reading. And, it seems, this doesn't simply consist in seeing and pronouncing the words, but, besides, in an experience of an intimate character, as I should like to say. (I am as it were on an intimate footing with the word 'I read'.)

Page 167

In reading the spoken words come in a particular way, I am inclined to say; and the written words themselves which I read don't just look to me like any kind of scribbles. At the same time I am unable to point to, or get a grasp on, that 'particular way'.

Page 167

The phenomenon of seeing and speaking the words seems enshrouded by a particular atmosphere. But I don't recognize this atmosphere as one which always characterized the situation of reading. Rather, I notice it when I read a line, trying to see what reading is like.

Page 167

When noticing this atmosphere I am in the situation of a man who is working in his room, reading, writing, speaking, etc., and

Page Break 168

who suddenly concentrates his attention on some soft uniform noise, such as one can almost always hear, particularly in a town (the dim noise resulting from all the various noises of the street, the sounds of wind, rain, workshops, etc.). We could imagine that this man might think that a particular noise was a common element of all the experiences he had in this room. We should then draw his attention to the fact that most of the time he hadn't noticed any noises going on outside, and secondly, that the noise he could hear wasn't always the same (there was sometimes wind, sometimes not, etc.).

Page 168

Now we have used a misleading expression when we said that besides the experiences of seeing and speaking in reading there was another experience, etc. This is saying that to certain experiences another experience is added.--Now take the experience of seeing a sad face, say in a drawing,--we can say that to see the drawing as a sad face is not 'just' to see it as some complex of strokes (think of a puzzle picture). But the word 'just' here seems to intimate that in seeing the drawing as a face some experience is added to the experience of seeing it as mere strokes; as though I had to say that seeing the drawing as a face consisted of two experiences, elements.

Page 168

You should now notice the difference between the various cases in which we say that an experience consists of several elements or that it is a *compound* experience. We might say to the doctor, "I don't have one pain; I have two: toothache and headache". And one might express this by saying, "My experience of pain is not simple, but compound, I have toothache and headache". Compare with this case that in which I say, "I have got both pains in my stomach and a general feeling of sickness". Here I don't separate the constituent experiences by pointing to two localities of pain. Or consider this statement: "When I drink sweet tea, my taste experience is a compound of the taste of sugar and the taste of tea". Or again: "If I hear the C Major chord my experience is composed of hearing C, E, and G". And, on the other hand, "I hear a piano playing and some noise in the street". A most instructive example is this: In a song words are sung to certain notes. In what sense is the experience of hearing the vowel *a* sung to the note C a composite one? Ask yourself in each of these cases: What is it like to single out the constituent experiences in the compound experience?

Page 168

Now although the expression that seeing a drawing as a face is not merely seeing strokes seems to point to some kind of addition of experiences, we certainly should not say that when we see the

Page Break 169

drawing as a face we also have the experience of seeing it as mere strokes and some other experience *besides*. And this becomes still clearer when we imagine that someone said that seeing the drawing

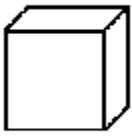

as a cube consisted in seeing it as a plane figure plus having an experience of depth.

Page 169

Now when I felt that though while reading a certain constant experience went on and on, I could not in a sense lay hold of that experience, my difficulty arose through wrongly comparing this case with one in which one part of my experience can be said to be an accompaniment of another. Thus we are sometimes tempted to ask: "If I feel this constant hum going on while I read, *where* is it?" I wish to make a pointing gesture, and there is nothing to point to. And the words "lay hold of" express the same misleading analogy.

Page 169

Instead of asking the question "Where is this constant experience which seems to go on all through my reading?", we should ask "What is it in saying 'A particular atmosphere enshrouds the words which I am reading', that I am contrasting this case with?"

Page 169

I will try to elucidate this by an analogous case: We are inclined to be puzzled by the three-dimensional appearance of the drawing

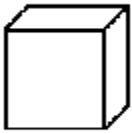

in a way expressed by the question "What does seeing it three-dimensionally consist in?" And this question really asks 'What is it that is added to simply seeing the drawing when we see it three-dimensionally?' And yet what answer can we expect to this question? It is the form of this question which produces the puzzlement. As Hertz says: "Aber offenbar irrt die Frage in Bezug auf die Antwort, welche sie erwartet" (p. 9, Einleitung, *Die Prinzipien der Mechanik*). The question itself keeps the mind pressing against a blank wall, thereby preventing it from ever finding the outlet. To show a man how to get out you have first of all to free him from the misleading influence of the question.

Page Break 170

Page 170

Look at a written word, say "read",--"It isn't just a scribble, it's 'read'", I should like to say, "it has one definite physiognomy". But what is it that I am really saying about it? What is this statement, straightened out? "The word falls", one is tempted to explain, "into a mould of my mind *long* prepared for it". But as I don't perceive both the word and a mould, the metaphor of the word's fitting a mould can't allude to an experience of comparing the hollow and the solid shape before they are fitted together, but rather to an experience of seeing the solid shape accentuated by a particular background.



i) would be the picture of the hollow and the solid shape before they are fitted together. We here see two circles and can compare them. ii) is the picture of the solid in the hollow. There is only one circle, and what we call the mould only accentuates, or as we sometimes said, emphasizes it.

Page 170

I am tempted to say, "This isn't just a scribble, but it's *this* particular face".--But I can't say, "I see *this* as *this* face", but ought to say "I see this as a face". But I feel I want to say, "I don't see this as *a* face, I see it as *this* face". But in the second half of this sentence the word "face" is redundant, and it should have run, "I don't see this as a face, I see it like *this*".

Page 170

Suppose I said "I see this scribble like *this*", and while saying "this scribble" I look at it as a mere scribble, and while saying "like *this*", I see the face,--this would come to something like saying "What at one time appears to me like this, at another appears to me like that", and here the "this" and the "that" would be accompanied by the two different ways of seeing.--But we must ask ourselves in what game is this sentence with the processes accompanying it to be used. E.g., whom am I telling this? Suppose the answer is "I'm saying it to myself". But that is

not enough. We are here in the grave danger of believing that we know what to do with a sentence if it looks more or less like one of the common sentences of our language. But here in order not to be deluded we have to ask ourselves: What is the use, say, of the words "this" and "that"?--or rather, What are the different uses which we make of them? What we call their meaning is not anything which they have got in them or which is fastened to them irrespective of what use we make of them. Thus it is one use of the

Page Break 171

word "this" to go along with a gesture pointing to something: We say "I am seeing the square with the diagonals like this", pointing to a swastika. And referring to the square with diagonals I might have said, "What at one time appears to me like this



at another time appears to me like that

And this is certainly not the use we made of the sentence in the above case.--One might think the whole difference between the two cases is this, that in the first the pictures are mental, in the second, real drawings. We should here ask ourselves in what sense we can call mental images pictures, for in some ways they are comparable to drawn or painted pictures, and in others not. It is, e.g., one of the essential points about the use of a 'material' picture that we say that it remains the same not only on the ground that it seems to us to be the same, that we remember that it looked before as it looks now. In fact we shall say under certain circumstances that the picture hasn't changed although it seems to have changed; and we say it hasn't changed because it has been kept in a certain way, certain influences have been kept out. Therefore the expression "The picture hasn't changed" is used in a different way when we talk of a material picture on the one hand, and of a mental one on the other. Just as the statement "These ticks follow at equal intervals" has got one grammar if the ticks are the tick of a pendulum and the criterion for their regularity is the result of measurements which we have made on our apparatus, and another grammar if the ticks are ticks which we imagine. I might for instance ask the question: When I said to myself "What at one time appears to me like this, at another...", did I recognize the two aspects, this and that, as the same which I got on previous occasions? Or were they new to me and I tried to remember them for future occasions? Or was all that I meant to say "I can change the aspect of this figure"?

Page 171

19. The danger of delusion which we are in becomes most clear if we propose to ourselves to give the aspects 'this' and 'that' names,

Page Break 172

say A and B. For we are most strongly tempted to imagine that giving a name consists in correlating in a peculiar and rather mysterious way a sound (or other sign) with something. How we make use of this peculiar correlation then seems to be almost a secondary matter. (One could almost imagine that naming was done by a peculiar sacramental act, and that this produced some magic relation between the name and the thing.)

Page 172

But let us look at an example; consider this language game: A sends B to various houses in their town to fetch goods of various sorts from various people. A gives B various lists. On top of every list he puts a scribble, and B is trained to go to that house on the door of which he finds the same scribble, this is the name of the house. In the first column of every list he then finds one or more scribbles which he has been taught to read out. When he enters the house he calls out these words, and every inhabitant of the house has been trained to run up to him when a certain one of these sounds is called out, these sounds are the names of the people. He then addresses himself to each one of them in turn and shows to each two consecutive scribbles which stand on the list against his name. The first of these two, people of that town have been trained to associate with some particular kind of object, say, apples. The second is one of a series of scribbles which each man carries about him on a slip of paper. The person thus addressed fetches say, five apples. The first scribble was the generic name of the objects required, the second, the name of their number.

Page 172

What now is the relation between a name and the object named, say, the house and its name? I suppose we could give either of two answers. The one is that the relation consists in certain strokes having been painted on the door of the house. The second answer I meant is that the relation we are concerned with is established, not just by painting these strokes on the door, but by the particular role which they play in the practice of our language as we have been sketching it.--Again, the relation of the name of a person to the person here consists in the person having been trained to run up to someone who calls out the name; or again, we might say that it consists in this and the whole of the usage of the name in the language game.

Page 172

Look into this language game and see if you can find the mysterious relation of the object and its name.--The relation of name and object we may say, consists in a scribble being written on an object (or some other such very trivial relation), and that's all there is to it. But we are not satisfied with that, for we feel that a scribble written on an

Page Break 173

object in itself is of no importance to us, and interests us in no way. And this is true; the whole importance lies in the particular use we make of the scribble written on the object, and we, in a sense, simplify matters by saying that the name has a peculiar relation to its object, a relation other than that, say, of being written on the object, or of being spoken by a person pointing to an object with his finger. A primitive philosophy condenses the whole usage of the name into the idea of a relation, which thereby becomes a mysterious relation. (Compare the ideas of mental activities, wishing, believing, thinking, etc., which for the same reason have something mysterious and inexplicable about them.)

Page 173

Now we might use the expression "The relation of name and object does not merely consist in this kind of trivial, 'purely external', connection", meaning that what we call the relation of name and object is characterized by the entire usage of the name; but then it is dear that there is no one relation of name to object, but as many as there are uses of sounds or scribbles which we call names.

Page 173

We can therefore say that if naming something is to be more than just uttering a sound while pointing to something, there must also be, in some form or other, the knowledge of how in the particular case the sound or scratch is to be used.

Page 173

Now when we proposed to give the aspects of a drawing names, we made it appear that by seeing the drawing in two different ways, and each time saying something, we had done more than performing just this uninteresting action; whereas we now see that it is the usage of the 'name' and in fact the detail of this usage which gives the naming its peculiar significance.

Page 173

It is therefore not an unimportant question, but a question about the essence of the matter; "Are 'A' and 'B' to remind me of these aspects; can I carry out such an order as 'See this drawing in the aspect A'; are there, in some way, pictures of these aspects correlated with the names 'A' and 'B' (like



and);

are 'A' and 'B' used in communicating with other people, and what exactly is the game played with them?"

Page Break 174

Page 174

When I say "I don't see mere dashes (a mere scribble) but a face (or word) with this particular physiognomy", I don't wish to assert any general characteristic of what I see, but to assert that I see that particular physiognomy which I do see. And it is obvious that here my expression is moving in a circle. But this is so because really the particular physiognomy which I saw ought to have entered my proposition.--When I find that "In reading a sentence, a peculiar experience goes on all the while", I have actually to read over a fairly long stretch to get the peculiar impression which makes one say this.

Page 174

I might then have said "I find that the same experience goes on all the time", but I wished to say: "I don't just notice that it's the same experience throughout, I notice a particular experience". Looking at a uniformly coloured wall I might say, "I don't just see that it has the same colour all over, but I see a particular colour". But in saying this I am mistaking the function of a sentence.--It seems that you wish to specify the colour you see, but not by saying anything about it, nor by comparing it with a sample,--but by pointing to it; using it at the same time as the sample and that which the sample is compared with.

Page 174

Consider this example: You tell me to write a few lines, and while I am doing so you ask "Do you feel something in your hand while you are writing?" I say, "Yes, I have a peculiar feeling".--Can't I say to myself when I write, "I have *this* feeling"? Of course I can say it, and while saying "this feeling", I concentrate on the feeling.--But what do I do with this sentence? What use is it to me? It seems that I am pointing out to myself what I am feeling,--as though my act of concentration was an 'inward' act of pointing, one which no one else but me is aware

of, this however is unimportant. But I don't point to the feeling by attending to it. Rather, attending to the feeling means producing or modifying it. (On the other hand, observing a chair does not mean producing or modifying the chair.)

Page 174

Our sentence "I have *this* feeling while I'm writing" is of the kind of the sentence "I see this". I don't mean the sentence when it is used to inform someone that I am looking at the object which I am pointing to, nor when it is used, as above, to convey to someone that I see a certain drawing in the way A and not in the way B. I mean the sentence, "I see this", as it is sometimes contemplated by us when we are brooding over certain philosophical problems. We are then, say, holding on to a particular visual impression by staring at some object, and we feel it is most natural to say to ourselves "I see this", though we know of no further use we can make of this sentence.

Page Break 175

Page 175

20. 'Surely it makes sense to say what I see, and how better could I do this than by letting what I see speak for itself!'

Page 175

But the words "I see" in our sentence are redundant. I don't wish to tell myself that it is I who see this, nor that I *see* it. Or, as I might put it, it is impossible that I should not see *this*. This comes to the same as saying that I can't point out to myself by a visual hand what I am seeing; as this hand does not point to what I see but is part of what I see.

Page 175

It is as though the sentence was singling out the particular colour I saw; as if it presented it to me.

Page 175

It seems as though the colour which I see was its own description.

Page 175

For the pointing with my finger was ineffectual. (And the looking is no pointing, it does not, for me, indicate a direction, which would mean contrasting a direction with other directions.)

Page 175

What I see, or feel, enters my sentence as a sample does; but no use is made of this sample; the words of my sentence don't seem to matter, they only serve to present the sample to me.

Page 175

I don't really speak *about* what I see, but *to* it.

Page 175

I am in fact going through the acts of attending which could accompany the use of a sample. And this is what makes it seem as though I was making use of a sample. This error is akin to that of believing that an ostensive definition says something about the object to which it directs our attention.

Page 175

When I said "I am mistaking the function of a sentence" it was because by its help I seemed to be pointing out to myself which colour it is I see, whereas I was just contemplating a sample of a colour. It seemed to me that the sample was the description of its own colour.

Page 175

21. Suppose I said to someone: "Observe the particular lighting of this room".--Under certain circumstances the sense of this order will be quite clear, e.g., if the walls of the room were red with the setting sun. But suppose at any other time when there is nothing striking about the lighting I said "Observe the particular lighting of this room":--Well, isn't there a particular lighting? So what is the difficulty about observing it? But the person who was told to observe the lighting when there was nothing striking about it would probably look about the room and say "Well, what about it?" Now I might go on and say "It is exactly the same lighting as yesterday at this hour",

Page Break 176

or "It is just this slightly dim light which you see in this picture of the room".

Page 176

In the first case, when the room was lit a striking red, you could have pointed out the peculiarity which you were meant, though not explicitly told, to observe. You could, e.g., have used a sample of the particular colour in order to do so. We shall in this case be inclined to say that a peculiarity was added to the normal appearance of the room.

Page 176

In the second case, when the room was just ordinarily lighted and there was nothing striking about its

appearance, you didn't know exactly what to do when you were told to observe the lighting of the room. All you could do was to look about you waiting for something further to be said which would give the first order its full sense.

Page 176

But wasn't the room, in both cases, lit in a particular way? Well, this question, as it stands, is senseless, and so is the answer "It was...". The order "Observe the particular lighting of this room", does not imply any statement about the appearance of this room. It seemed to say: "This room has a particular lighting, which I need not name; observe it!" The lighting referred to, it seems, is given by a sample, and you are to make use of the sample; as you would be doing in copying the precise shade of a colour sample on a palette. Whereas the order is similar to this: "Get hold of this sample!"

Page 176

Imagine yourself saying "There is a particular lighting which I'm to observe". You could imagine yourself in this case staring about you in vain, that is, without seeing the lighting.

Page 176

You could have been given a sample, e.g., a piece of colour material, and been asked: "Observe the colour of this patch".-And we can draw a distinction between observing, attending to, the shape of the sample and attending to its colour. But, attending to the colour can't be described as looking at a thing which is connected with the sample, rather, as looking at the sample in a peculiar way.

Page 176

When we obey the order, "Observe the colour...", what we do is to open our eyes to colour. "Observe the colour..." doesn't mean "See the colour you see". The order, "Look at so and so", is of the kind, "Turn your head in this direction"; what you will see when you do so does not enter this order. By attending, looking, you produce the impression; you can't look at the impression.

Page 176

Suppose someone answered to our order: "All right, I am now observing the particular lighting this room has",--this would sound as though he could point out to us which lighting it was. The order, that is to say, may seem to have told you to do something with this

Page Break 177

particular lighting, as opposed to another one (like "Paint this lighting, not that"). Whereas you obey the order by taking in *lighting*, as opposed to dimensions, shapes, etc.

Page 177

(Compare, "Get hold of the colour of this sample" with "Get hold of this pencil", i.e., there it is, take hold of it.)

Page 177

I return to our sentence: "this face has a particular expression". In this case too I did not compare or contrast my impression with anything, I did not make use of the sample before me. The sentence was an utterance†1 of a state of attention.

Page 177

What has to be explained is this: Why do we talk to our impression?--You read, put yourself into a state of attention and say: "Something peculiar happens undoubtedly". You are inclined to go on: "There is a certain smoothness about it"; but you feel that this is only an inadequate description and that the experience can only stand for itself. "Something peculiar happens undoubtedly" is like saying, "I have had an experience". But you don't wish to make a general statement independent of the particular experience you have had, but rather a statement into which this experience enters.

Page 177

You are under an impression. This makes you say "I am under a *particular* impression", and this sentence seems to say, to yourself at least, under what impression you are. As though you were referring to a picture ready in your mind, and said "This is what my impression is like". Whereas you have only pointed to your impression. In our case (p. 174), saying "I notice the particular colour of this wall" is like drawing, say, a black rectangle enclosing a small patch of the wall and thereby designating that patch as a sample for further use.

Page 177

When you read, as it were attending closely to what happened in reading, you seemed to be observing reading as under a magnifying glass and to see the reading process. (But the case is more like that of observing something through a coloured glass.) You think you have noticed the process of reading, the particular way in which signs are translated into spoken words.

Page 177

22. I have read a line with a peculiar attention; I am impressed by the reading, and this makes me say that I have observed something besides the mere seeing of the written signs and the speaking of words. I have also expressed it by saying that I have noticed a particular atmosphere round the seeing and speaking. How such a metaphor as that embodied in the last sentence can come to suggest

Page Break 178

itself to me may be seen more clearly by looking at this example: If you heard sentences spoken in a monotone, you might be tempted to say that the words were all enshrouded in a particular atmosphere. But wouldn't it be using a peculiar way of representation to say that speaking the sentence in a monotone was adding something to the mere saying of it? Couldn't we even conceive speaking in a monotone as the result of *taking away* from the sentence its inflexion? Different circumstances would make us adopt different ways of representation. If, e.g., certain words had to be read out in a monotone, this being indicated by a staff and a sustained note beneath the written words, this notation would very strongly suggest the idea that something had been added to the mere speaking of the sentence.

Page 178

I am impressed by the reading of a sentence, and I say the sentence has shown me something, that I have noticed something in it. This made me think of the following example: A friend and I once looked at beds of pansies. Each bed showed a different kind. We were impressed by each in turn. Speaking about them my friend said "What a variety of colour patterns, and each says something". And this was just what I myself wished to say.

Page 178

Compare such a statement with this: "Every one of these men says something".--

Page 178

If one had asked what the colour pattern of the pansy said, the right answer would have seemed to be that it said itself. Hence we could have used an intransitive form of expression, say "Each of these colour patterns impresses one".

Page 178

It has sometimes been said that what music conveys to us are feelings of joyfulness, melancholy, triumph, etc., etc. and what repels us in this account is that it seems to say that music is an instrument for producing in us sequences of feelings. And from this one might gather that any other means of producing such feelings would do for us instead of music.--To such an account we are tempted to reply "Music conveys to us *itself!*"

Page 178

It is similar with such expressions as "Each of these colour patterns impresses one". We feel we wish to guard against the idea that a colour pattern is a means to producing in us a certain impression--the colour pattern being like a drug and we interested merely in the effect this drug produces.--We wish to avoid any form of expression which would seem to refer to an effect produced by an object on a subject. (Here we are bordering on the problem of idealism and realism and on the problem whether statements of aesthetics are subjective or

Page Break 179

objective.) Saying, "I see this and am impressed" is apt to make it seem as though the impression was some feeling accompanying the seeing, and that the sentence said something like "I see this and feel a pressure".

Page 179

I could have used the expression "Each of these colour patterns has meaning"; but I didn't say "has meaning", for this would provoke the question, "What meaning?", which in the case we are considering is senseless. We are distinguishing between meaningless patterns and patterns which have meaning; but there is no such expression in our game as "This pattern has the meaning so and so". Nor even the expression "These two patterns have different meanings", unless this is to say: "These are two different patterns and both have meaning".

Page 179

It is easy to understand though why we should be inclined to use the transitive form of expression. For let us see what use we make of such an expression as "This face says something", that is, what the situations are in which we use this expression, what sentences would precede or follow it (what kind of conversation it is a part of). We should perhaps follow up such a remark by saying, "Look at the line of these eyebrows" or "The *dark* eyes and the *pale* face!", these expressions would draw attention to certain features. We should in the same connection use comparisons, as for instance, "The nose is like a beak",--but also such expressions as "The whole face expresses bewilderment", and here we have used "expressing" transitively.

Page 179

23. We can now consider sentences which, as one might say, give an analysis of the impression we get, say, from a face. Take such a statement as, "The particular impression of this face is due to its small eyes and low

forehead". Here the words "the particular impression" may stand for a certain specification, e.g., "the stupid expression". Or, on the other hand, they may mean 'what makes this expression a striking one' (i.e., an extraordinary one); or, 'what strikes one about this face' (i.e., 'what draws one's attention'). Or again, our sentence may mean "If you change *these* features in the slightest the expression will change entirely (whereas you might change other features without changing the expression nearly so much)". The form of this statement, however, mustn't mislead us into thinking that there is in every case a supplementing statement of the form "First the expression was *this*, after the change it's *that*". We can, of course, say "Smith frowned, and his expression changed from this to that", pointing, say, at two drawings

Page Break 180

of his face.--(Compare with this the two statements: "He said these words", and "His words said something".)

Page 180

When, trying to see what reading consisted in, I read a written sentence, let the reading of it impress itself upon me, and said that I had a particular impression, one could have asked me such a question as whether my impression was not due to the particular handwriting. This would be asking me whether my impression would not be a different one if the writing had been a different one, or say, if each word of the sentence were written in a different handwriting. In this sense we could also ask whether that impression wasn't due after all to the *sense* of the particular sentence which I read. One might suggest: Read a different sentence (or the same one in a different handwriting) and see if you would still say that you had the same impression. And the answer might be: "Yes, the impression I had was really due to the handwriting".--But this would *not* imply that when I first said the sentence gave me a particular impression I had contrasted one impression with another, or that my statement had not been of the kind "This sentence has *its own character*". This will get clearer by considering the following example: Suppose we have three faces drawn side by side:



I contemplate the first one, saying to myself "This face has a peculiar expression". Then I am shown the second one and asked whether it has the same expression. I answer "Yes". Then the third one is shown to me and I say "It has a different expression". In my two answers I might be said to have distinguished the face and its expression: for b) is different from a) and still I say they have the same expression, whereas the difference between c) and a) corresponds to a difference of expression; and this may make us think that also in my first utterance I distinguished between the face and its expression.

Page 180

24. Let us now go back to the idea of a feeling of familiarity, which arises when I see familiar objects. Pondering about the question whether there is such a feeling or not, we are likely to gaze at some object and say, "Don't I have a particular feeling when I look at my old coat and hat?" But to this we now answer: What feeling do you compare this with, or oppose it to? Should you say that your old coat gives you the same feeling as your old friend A with whose

Page Break 181

appearance too you are well acquainted, or that *whenever* you happened to look at your coat you get that feeling, say of intimacy and warmth?

Page 181

'But is there no such thing as a feeling of familiarity?'--I should say that there are a great many different experiences, some of them feelings, which we might call "experiences (feelings) of familiarity".

Page 181

Different experiences of familiarity: a) Someone enters my room, I haven't seen him for a long time, and didn't expect him. I look at him, say or feel "Oh, it's you".--Why did I in giving this example say that I hadn't seen the man for a long time? Wasn't I setting out to describe *experiences of familiarity*? And whatever the experience was I alluded to, couldn't I have had it even if I had seen the man half an hour ago? I mean, I gave the circumstances of recognizing the man as a means to the end of describing the precise situation of the recognition. One might object to this way of describing the *experience*, saying that it brought in irrelevant things, and in fact wasn't a *description* of the feeling at all. In saying this one takes as the prototype of a description, say, the description of a table, which tells you the exact shape, dimensions, the material which it is made of, and its colour. Such a description one might say pieces the table together. There is on the other hand a different kind of description of a table, such as you might find in a novel, e.g., "It was a small rickety table decorated in Moorish style, the sort that is used for smoker's

requisites". Such a description might be called an indirect one; but if the purpose of it is to bring a vivid image of the table before your mind in a flash, it might serve this purpose incomparably better than a detailed 'direct' description.--Now if I am to give the description of a feeling of familiarity or recognition,--what do you expect me to do? Can I piece the feeling together? In a sense of course I could, giving you many different stages and the way my feelings changed. Such detailed descriptions you can find in some of the great novels. Now if you think of descriptions of pieces of furniture as you might find them in a novel, you see that to this kind of description you can oppose another making use of drawings, measures such as one should give to a cabinet maker. This latter kind one is inclined to call the only direct and complete description (though this way of expressing ourselves shows that we forget that there are certain purposes which the 'real' description does not fulfil). These considerations should warn you not to think that there is one real and direct description of, say, the feeling of recognition as opposed to the 'indirect' one which I have given.

Page Break 182

Page 182

b) The same as a), but the face is not familiar to me immediately. After a little, recognition 'dawns upon me'. I say, "Oh, it's you", but with totally different inflexion than in a). (Consider tone of voice, inflexion, gestures, as *essential* parts of our experience, not as inessential accompaniments or mere means of communication. (Compare pp. 144-6.)) c) There is an experience directed towards people or things which we see every day when suddenly we feel them to be 'old acquaintances' or 'good old friends'; one might also describe the feeling as one of warmth or of being at home with them. d) My room with all the objects in it is thoroughly familiar to me. When I enter it in the morning do I greet the familiar chairs, tables, etc., with a feeling of "Oh, hello!"? or have such a feeling as described in c)? But isn't the way I walk about in it, take something out of a drawer, sit down, etc., different from my behaviour in a room I don't know? And why shouldn't I say therefore, that I had experiences of familiarity whenever I lived amongst these familiar objects? e) Isn't it an experience of familiarity when on being asked "Who is this man?" I answer straight away (or after some reflection) "It is so and so"? Compare with this experience, f), that of looking at the written word "feeling" and saying "This is A's handwriting" and on the other hand g) the experience of reading the word, which also is an experience of familiarity.

Page 182

To e) one might object, saying that the experience of saying the man's name was not the experience of familiarity, that he had to be familiar to us in order that we might know his name, and that we had to *know his name* in order that we might say it. Or, we might say "Saying his name is not enough, for surely we might say the name without knowing that it was his name". And this remark is certainly true if only we realize that it does not imply that knowing the name is a process accompanying or preceding saying the name.

Page 182

25. Consider this example: What is the difference between a memory image, an image that comes with expectation, and say, an image of a daydream. You may be inclined to answer, "There is an intrinsic difference between the images".--Did you notice that difference, or did you only say there was one because you think there must be one?

Page 182

But surely I recognize a memory image as a memory image, an image of a daydream as an image of a daydream, etc.!--Remember that you are sometimes doubtful whether you actually saw a certain

Page Break 183

event happening or whether you dreamt it, or just had heard of it and imagined it vividly. But apart from that, what do you mean by "recognizing an image as a memory image"? I agree that (at least in most cases) while an image is before your mind's eye you are not in a state of doubt as to whether it is a memory image, etc. Also, if asked whether your image was a memory image, you would (in most cases) answer the question without hesitation. Now what if I asked you "When do you know what sort of an image it is?" Do you call knowing what sort of image it is not being in a state of doubt, not wondering about it? Does introspection make you see a state or activity of mind which you would call knowing that the image was a memory image, and which takes place while the image is before your mind?--Further, if you answer the question what sort of image it was you had, do you do so by, as it were, looking at the image and discovering a certain characteristic in it (as though you had been asked by whom a picture was painted, looked at it, recognized the style, and said it was a Rembrandt)?

Page 183

It is easy, on the other hand, to point out experiences characteristic of remembering, expecting, etc., accompanying the images, and further differences in the immediate or more remote surrounding of them. Thus we certainly *say* different things in the different cases, e.g., "I remember his coming into my room", "I expect his

coming into my room", "I imagine his coming into my room".-"But surely this can't be all the difference there is!" It isn't all: There are the three different games played with these three words surrounding these statements.

Page 183

When challenged: do we *understand* the word "remember", etc.? is there really a difference between the cases besides the mere verbal one? our thoughts move in the immediate surroundings of the image we had or the expression we used. I have an image of dining in Hall with T. If asked whether this is a memory image, I say "Of course", and my thoughts begin to move on paths starting from this image. I remember who sat next to us, what the conversation was about, what I thought about it, what happened to T later on, etc., etc.

Page 183

Imagine two different games both played with chess men on a chess board. The initial positions of both are alike. One of the games is always played with red and green pieces, the other with black and white. Two people are beginning to play, they have the chess board between them with the green and red pieces in position. Someone asks them "Do you know what game you're intending to play?" A player answers "Of course; we are playing no. 2". "What is the

Page Break 184

difference now between playing no. 2 and no. 1?"--"Well, there are red and green pieces on the board and not black and white ones, also we say that we are playing no. 2".--"But this couldn't be the only difference; don't you *understand* what 'no. 2' means and what game the red and green pieces stand for?" Here we are inclined to say "Certainly I do", and to prove this to ourselves we actually begin to move the pieces according to the rules of game no. 2. This is what I should call moving in the immediate surrounding of our initial position.

Page 184

But isn't there also a peculiar feeling of pastness characteristic of images as memory images? There certainly are experiences which I should be inclined to call feelings of pastness, although not always when I remember something is one of these feelings present.--To get clear about the nature of these feelings it is again very useful to remember that there are gestures of pastness and inflexions of pastness which we can regard as representing the experiences of pastness.

Page 184

I will examine one particular case, that of a feeling which I shall roughly describe by saying it is the feeling of 'long, long ago'. These words and the tone in which they are said are a gesture of pastness. But I will specify the experience which I mean still further by saying that it is that corresponding to a certain tune (Davids Bündler Tänze--"Wie aus weiter Ferne"). I'm imagining this tune played with the right expression and thus recorded, say, for a gramophone. Then this is the most elaborate and exact expression of a feeling of pastness which I can imagine.

Page 184

Now should I say that hearing this tune played with this expression is in itself that particular experience of pastness, or should I say that hearing the tune causes the feeling of pastness to arise and that this feeling accompanies the tune? I.e., can I separate what I call this experience of pastness from the experience of hearing the tune? Or, can I separate an experience of pastness expressed by a gesture from the experience of making this gesture? Can I discover something, the essential feeling of pastness, which remains after abstracting all those experiences which we might call the experiences of expressing the feeling?

Page 184

I am inclined to suggest to you to put the expression of our experience in place of the experience. 'But these two aren't the same'. This is certainly true, at least in the sense in which it is true to say that a railway train and a railway accident aren't the same thing. And yet there is a justification for talking as though the expression "the gesture

Page Break 185

'long, long ago"', and the expression "the feeling 'long, long ago'" had the same meaning. Thus I could give the rules of chess in the following way: I have a chess board before me with a set of chess men on it. I give rules for moving these particular chess men (these particular pieces of wood) on this particular board. Can these rules be the rules of the game of chess? They can be converted into them by the usage of a single operator, such as the word "any". Or, the rules for my particular set may stand as they are and be made into rules of the game of chess by changing our standpoint towards them.

Page 185

There is the idea that the feeling, say, of pastness, is an amorphous something in a place, the mind, and that this something is the cause or effect of what we call the expression of feeling. The expression of feeling then is an indirect way of transmitting the feeling. And people have often talked of a direct transmission of feeling which

would obviate the external medium of communication..

Page 185

Imagine that I tell you to mix a certain colour and I describe the colour by saying that it is that which you get if you let sulphuric acid react on copper. This might be called an indirect way of communicating the colour I meant. It is conceivable that the reaction of sulphuric acid on copper under certain circumstances does not produce the colour I wished you to mix, and that on seeing the colour you had got I should have to say "No, it's not this", and to give you a sample.

Page 185

Now can we say that the communication of feelings by gestures is in this sense indirect? Does it make sense to talk of a direct communication as opposed to that indirect one? Does it make sense to say "I can't feel his toothache, but if I could I'd know what he feels like"?

Page 185

If I speak of communicating a feeling to someone else, mustn't I in order to understand what I say know what I shall call the criterion of having succeeded in communicating?

Page 185

We are inclined to say that when we communicate a feeling to someone, something which we can never know happens at the other end. All that we can receive from him is again an expression. This is closely analogous to saying that we can never know when in Fizeau's experiment the ray of light reaches the mirror.

FOOTNOTES

Page 8

†1 See pp. 16, 44ff.

Page 11

†1 This promise is not kept.--*Edd.*

Page 12

†1 This he never does.--*Edd.*

Page 16

†1 See p. 47 for a few further remarks on this topic.--*Edd.*

Page 20

†1 *Theaetetus* 146D-7C.

Page 21

†1 See *Tractatus* 5.02.

Page 22

†1 Cf. Russell, *Analysis of Mind*, III.

Page 31

†1 He does not do this.--*Edd.*

Page 82

†1 Here Wittgenstein uses "sentence" and "proposition" interchangeably for the German "*Satz*".--*Edd.*

Page 102

†1 German *lassen*, i.e. 'make'.--*Edd.*

Page 139

†1 German "nach", i.e. "according to" or "in the light of".--*Edd.*

Page 161

†1 Language game no. 30 in Part I of the *Brown Book*.

Page 165

†1 § 15, *Brown Book*, Part II.

Page 177

†1 *I.e.* Äußerung. See *Philosophical Investigations*, § 256.--*Edd.*

REMARKS ON THE FOUNDATIONS OF MATHEMATICS

REMARKS ON THE FOUNDATIONS OF MATHEMATICS

By
LUDWIG WITTGENSTEIN

Edited by
G. H. von WRIGHT, R. RHEES, G. E. M. ANSCOMBE

Translated by
G. E. M. ANSCOMBE

BASIL BLACKWELL
OXFORD

First printed 1956
Second edition 1967
Third edition, revised and reset, 1978
Reprinted 1989, 1994, 1998

ISBN 0-631-12505-1 (Pbk)

Printed in Great Britain by Athenæum Press Ltd, Gateshead, Tyne & Wear

TABLE OF CONTENTS PART I

1-5. Following a rule (Cf. *Philosophical Investigations* §§ 189-90 ff.).--Steps determined by a formula (1-2). Continuation of a series (3). Inexorability of mathematics; mathematics and truth (4-5). Remark on measuring (5).
35

6-23. Logical inference.--The word "all"; inference from ' $(x).fx$ ' to ' fa ' (10-16). Inference and truth (17-23).
39

24-74. Proof.--Proof as pattern or model (paradigm). Example: hand and pentacle (25 ff.). Proof as picture of an experiment (36). Example: 100 marbles (36 ff.). Construction of figures out of their parts (42-72). Mathematical surprise. Proof and conviction. Mathematics and essence (32, 73, 74). The depth of the essence: the deep need for the convention (74).
46

75-105. Calculation and experiment.--The 'unfolding' of mathematical properties. Example of 100 marbles (75, 86, 88). Unfolding the properties of a polygon (76), and of a chain (79, 80, 91, 92). Measuring (93, 94). Geometrical examples (96-98). Internal properties and relations (102-105); examples from the logic of colour.
65

106-112. Mathematical belief.
76

113-142. Logical compulsion.--In what sense does logical argument compel? (113-117). The inexorability of logic

compared with that of the law (118). The 'logical machine' and the kinematics of rigid bodies' (119-125). 'The hardness of the logical *must*' (121). The machine as symbolizing its way of working (122). The employment

Page Break 6

of a word grasped in a flash (123-130). Possibility as a shadow of reality (125). The employment of a word misunderstood and interpreted as a queer process (127). (For 122-130 see also *Philosophical Investigations* §§ 191-197.) The laws of logic as 'laws of thought' (131-133). Logic interprets 'proposition' and 'language' (134). Going wrong in a calculation (136-137). Remark on measuring (140). Logical impossibility (141). "What we are supplying is really remarks on the natural history of man" (142). 79

Page 6

143-156. Foundation of a calculating procedure and of a logical inference.--Calculating without propositions (143-145). Example: sale of timber (143-152). "Are our laws of inference eternal and unalterable"? (155). Logic precedes truth (156). 92

Page 6

157-170. Mathematics, logic and experience.--Proof and experiment (157-169). What about mathematics is logic: it moves in the rules of our language (165). The mathematician is an inventor, not a discoverer (168). The grounds of the logical *must* (169-171). 96

Appendix I

Page 6

1-7. Two sorts of negation. One cancels out when repeated, the other is still a negation. How we *mean* the one or the other sort in double negation. Meaning tested by the expression of meaning (3). Negation compared with rotation through 180° in geometry (1, 6, 7). 102

Page 6

8-10. We can imagine a 'more primitive' logic, in which only sentences containing no negation can be negated (8). The question whether negation has the same meaning for these people as for us (9). Does the figure one mean the same both times in "This rod is 1 metre long" and "Here is 1 soldier" (10)? 105

Page Break 7

Page 7

12-13. Two systems for measuring length. 1 foot = 1W, but 2W = 4 foot, etc. Do "W" and "foot" mean the same? 106

Page 7

16. Meaning as the function of a word in a sentence. 107

Page 7

17-27. Use of the word "is" as copula and as sign of identity. The personal union by the same word a mere accident. Essential and inessential features of a notation. Comparison with the role of a piece in a game. A game does not just have rules, it has a point (20). 108

Appendix II

Page 7

1-13. The surprising may play completely different roles in mathematics in two different ways.--A state of affairs may appear astonishing because of the kind of way it is represented. Or the emergence of a particular result may be seen as in itself surprising. The second kind of surprise not legitimate. Criticism of the conception that mathematical demonstration brings something hidden to light (2). "No mystery here" means: Look around (4). A calculation compared with a way of turning up a card (5). When we don't command a view over what we have been doing, it strikes us as mysterious. We adopt a particular form of expression and become dominated by it in acting and thinking (8). 111

Appendix III

Page 7

1-4. Kinds of proposition.--Arithmetic done without propositions (4). 116

Page 7

5-7. Truth and provability in the system of *Principia Mathematica*. 117

Page 7

8-19. Discussion of a proposition '*P*' which asserts its own unprovability

in the system of *Principia Mathematica*.--The role of contradiction in the language-game (11-14, 17).

118

20. The propositions of logic. 'Proposition' and 'proposition-like formation'.

123

PART II

1-22. ("Additions").--The diagonal procedure. What use can be made of the diagonal number? (3) "The motto here is: Take a *wider* look round" (6). We should regard with suspicion the result of a calculation expressed in words (7). The concept 'nondenumerable' (10-13). Comparison of the concepts 'real number' and 'cardinal number' from the point of view of serial ordering (16-22).

125

23. The sickness of a time.

132

24-27. Discussion of the proposition "There is no greatest cardinal number." "We say of a *licence* that it does not terminate" (26).

133

28-34. Irrational numbers. There is no system of irrational numbers (33). But Cantor defines a higher order difference, namely a difference between a development and a system of developments (34).

133

35-39. \aleph_0 . From our having a use for a kind of numeral that gives the number of terms of an infinite series it doesn't follow that it also makes any sense to talk about the number of the concept 'infinite series'. There is no grammatical technique suggesting the use of such an expression. Such a use is not still to be discovered, but takes inventing (38).

135

40-48. Discussion of the proposition "Fractions cannot be arranged in a series in order of magnitude."

137

49-50. How do we compare games?

139

51-57. Discussion of the proposition that fractions (number-pairs) can be ordered in an infinite series.

139

58-60. "Is the word 'infinite' to be avoided in mathematics?"

141

61. Finitism and Behaviourism are similar trends. Both deny the existence of something with a view to getting out of a muddle.

142

62. "What I am doing is not showing up calculations as wrong, but subjecting the *interest* of calculations to test."

142

PART III

1-2. Proof.--Mathematical proof must be perspicuous. Role of definitions (2). 143

3-8. Russell's logic and the idea of the reduction of arithmetic to symbolic logic.--The application of the calculation must take care of itself (4). Proof in the Russellian calculus, in the decimal calculus, and in the stroke calculus. 144

9-11. Proof.--Proof as a memorable picture (9). The reproduction of the pattern of a proof (10-11).

149

12-20. Russell's logic and the problem of the mutual relation of different calculating techniques.--What is the invention of the decimal system? (12.) Proof in the Russellian calculus and in the decimal system (13). Signs for

numbers that can, and that cannot, be taken in (16). Relation of abbreviated and unabbreviated calculating techniques to one another (17-20). 151

Page 9

21-44. Proof.--Identity and reproducibility of a proof (21). The proof

Page Break 10

as model. Proof and experiment (22-24). Proof and mathematical conviction (25-26). In the proof we have won through to a decision (27). The proved proposition as a rule. It serves to shew us what it makes *sense* to say (28). The propositions of mathematics as 'instruments of language' (29). The mathematical *must* correspond to a track which I lay down in language (30). The proof introduces a new concept (31). What concept does ' $p \supset p$ ' produce? (32). ' $p \supset p$ ' as pivot of the linguistic method of representation (33). The proof as part of an institution (36). Importance of the distinction between determining and using a sense (37). Acceptance of a proof; the 'geometrical' conception of proof (38-40). The proof as adoption of a particular employment of signs (41). "The proof must be a procedure plain to view" (42). "Logic as foundation of mathematics does not work if only because the cogency of the logical proof stands and falls with its geometrical cogency" (43). In mathematics we can get away from logical proofs (44). 158

Page 10

45-64. Russell's logic.--Relation between the ordinary and the Russellian technique of proof (45). Criticism of the conception of logic as the 'foundation' of mathematics. Mathematics is a *motley* of calculating techniques. The abbreviated technique as a new aspect of the unabbreviated (46-48). Remark on trigonometry (50). The decimal notation is independent of calculation with unit strokes (51). Why Russell's logic does not teach us to *divide* (52). Why mathematics is not logic (53). Recursive proof (54). Proof and experiment (55). The correspondence of different calculi; stroke notation and decimal notation (56-57). Several proofs of one and the same proposition; proof and the sense of a mathematical proposition (58-62). The *exact* correspondence of a convincing transition in music and in mathematics (63). 175

Page 10

65-76. Calculation and experiment.--Are the propositions of mathematics anthropological propositions? (65). Mathematical propositions conceived as prophecies of concordant results of calculating (66). Agreement is part of the phenomenon of

Page Break 11

calculating (67). If a calculation is an experiment, what in that case is a mistake in calculation? (68). The calculation as an experiment and as a *path* (69). A proof subserves mutual understanding. An experiment presupposes it (71). Mathematics and the science of conditioned calculating reflexes (72). The concept of calculation excludes confusion (75-76). 192

Page 11

77-90. Contradiction.--A game in which the one who moves first must always win (77). Calculating with $(a - a)$. The chasms in a calculus are not there if I do not see them (78). Discussion of the heterological paradox (79). Contradiction regarded from the point of view of the language-game. Contradiction as a 'hidden sickness' of the calculus (80). Contradiction and the usability of a calculus (81). The consistency proof and the misuse of the idea of *mechanical* insurance against contradiction (82-89). "My aim is to change the *attitude* towards contradiction and the consistency proof." (82) The role of the proposition: "I must have miscalculated"--the key to understanding the 'foundations' of mathematics (90). 202

PART IV

Page 11

1-7. On axioms.--The self-evidence of axioms (1-3). Self-evidence and use (2-3). Axiom and empirical proposition (4-5). The negation of an axiom (5). The mathematical proposition stands on four legs, not on three (7). 223

Page 11

8-9. Following a rule.--Description by means of a rule (8). 227

Page 11

10. The arithmetical assumption is not tied to experience. 229

Page 11

11-13. The conception of arithmetic as the natural history of numbers.--Judging experience by means of the picture (12). 229

Page Break 12

Page 12	14. External relation of the logical (mathematical) proposition.	231
Page 12	15-19. The possibility of doing applied mathematics without pure mathematics.--Mathematics need not be done in <i>propositions</i> ; the centre of gravity may lie in <i>action</i> (15). The commutative law as an example (16-17).	232
Page 12	20. Calculation as a mechanical activity.	234
Page 12	21. The picture as a proof.	235
Page 12	22-27. Intuition.	235
Page 12	26. What is the difference between <i>not</i> calculating and calculating <i>wrong</i> ?	236
Page 12	29-33. Proof and mathematical concept formation.--Proof alters concept formation. Concept formation as the limit of the empirical (29). Proof does not <i>compel</i> , but <i>guides</i> (30). Proof conducts our experience into definite channels (31, 33). Proof and prediction (33).	237
Page 12	34. The philosophical problem is: how can we tell the truth and at the same time <i>pacify</i> these strong prejudices?	242
Page 12	35-36. The mathematical proposition.--We acknowledge it <i>by</i> turning our back on it (35). The effect of the proof: one plunges into the new rule (36).	243
Page 12	39, 42. Synthetic character of mathematical propositions.--The distribution of primes as an example (42).	245
Page 12	40. The result set up as equivalent to the operation.	245
Page 12	41. That proof must be perspicuous means that causality plays no part in proof.	246
Page Break 13		
Page 13	43-44. Intuition in mathematics.	246
Page 13	47. The mathematical proposition as determination of a concept, following upon the discovery of a new form.	248
Page 13	48. The working of the mathematical machine is only the <i>picture</i> of the working of a machine.	249
Page 13	49. The picture as a proof.	249
Page 13	50-51. Reversal of a word.	250
Page 13	52-53. Mathematical and empirical propositions.--The assumption of a mathematical concept expresses the confident expectation of certain experiences; but the establishment of this measure is not equivalent to the expression of the expectations (53).	253
Page 13	55-60. Contradiction.--The liar (58). Contradiction conceived as something supra-propositional, as a monument with a Janus head enthroned above the propositions of logic (59).	254

PART V

Page 13	1-4. Mathematics as a game and as a machine-like activity.--Does the calculating machine calculate? (2). How far is it necessary to have a concept of 'proposition' in order to understand Russell's mathematical logic? (4).
---------	---

Page 13

5-8. Is a misunderstanding about the possible application of mathematics any objection to a calculation as part of mathematics?--Set theory (7). 259

Page 13

9-13. The law of excluded middle in mathematics.--Where there is nothing to base a decision on, we must invent something in order to give the application of the law of excluded middle a sense. 266

Page Break 14

Page 14

14-16 and 21-23. 'Alchemy' of the concept of infinity and of other mathematical concepts whose application is not understood.--Infinite predictions (23). 272

Page 14

17-20. The law of excluded middle. The mathematical proposition as a commandment. Mathematical existence. 275

Page 14

24-27. Existence proofs in mathematics.--"The harmful invasion of mathematics by logic" (24; see also 46 and 48). The mathematically general does not stand to the mathematically particular in the same relation as does the general to the particular elsewhere (25). Existence proofs which do not admit of the construction of what exists (26-27). 281

Page 14

28. Proof by *reductio ad absurdum*. 285

Page 14

29-40. Extensional and intensional in mathematics; the Dedekind cut--geometrical illustration of analysis (2q) [[sic, 9?]]. Dedekind's theorem without irrational numbers (30). How does this theorem come by its deep content? (31) The picture of the number-line (32, 37). Discussion of the concept "cut" (33, 34). The totality of functions is an unordered totality (38). Discussion of the mathematical concept of a function; extension and intension in analysis (39-40). 285

Page 14

41. Concepts occurring in 'necessary' propositions must also have a meaning in non-necessary ones. 295

Page 14

42-46. On proof and understanding of a mathematical proposition.--The proof conceived as a *movement* from one concept to another (42). Understanding a mathematical proposition (45-46). The proof introduces a new concept. The proof serves to convince one of something (45). Existence proof and construction (46). 295

Page 14

47. A concept is not essentially a predicate. 299

Page Break 15

Page 15

48. 'Mathematical logic' has completely blinded the thinking of mathematicians and philosophers. 300

Page 15

49. The numerical sign goes along with the sign for a concept and only together with this is it a measure. 300

Page 15

50. On the concept of generality. 300

Page 15

51. The proof shews *how* the result is yielded. 301

Page 15

52-53. General remarks.--The philosopher is the man who has to cure himself of many sicknesses of the understanding before he can reach the notions of the healthy human understanding. 301

PART VI

Page 15

1. Proofs give propositions an order. 303

Page 15

2. Only within a *technique* of transformation is a proof a formal test. The addition of certain numbers is called a formal test of the numerals, but only because adding is a practised technique. The proof also hangs together with the application. 303

Page 15

3. When the proposition in application does not seem to be right, the proof must shew one why and how it *must* be right. 305

Page 15

4. The proof shews how, and thus why the rule--e.g., that 8×9 makes 72--can be used. 305

Page 15

5. The queer thing is that the picture, not the reality, is supposed to prove a proposition. 306

Page 15

6. The Euclidean proof teaches us a technique of finding a prime number between p and $p!$ And we become convinced that this technique must always lead to a prime number $> p$. 307

Page Break 16

Page 16

7. The spectator sees the impressive procedure and judges "I realise that it must be like that."--This "must" shews what kind of instruction he has drawn from the scene. 308

Page 16

8. This *must* shew that he has adopted a concept, i.e., a method; as opposed to the application of the method. 309

Page 16

9. "Shew me how 3 and 2 make 5." Child and abacus.--One would ask someone "how?" if one wanted to get him to shew that he understands what is in question here. 310

Page 16

10. "Shew me how..." in distinction from "Shew me that..." 312

Page 16

11. The proof of a proposition doesn't mention the whole system of calculation behind the proposition, which gives it sense. 313

Page 16

12. The domain of the tasks of philosophy. 314

Page 16

13. Ought we to say that mathematicians don't understand Fermat's last theorem? 314

Page 16

14. What would it be to "shew how there are infinitely many prime numbers"? 315

Page 16

15. The process of copying. The process of construction according to a rule. Must one always have a clear idea whether his prediction is intended mathematically or otherwise? 316

Page 16

16. The inexorable proposition is that by this rule this number follows after that one. The result of the operation here turns into the criterion for this operation's having been carried out. So we are able to judge in a new sense whether someone has followed the rule. 318

Page Break 17

Page 17

17. The learning of a rule.--"It's supposed to keep on as I have shewn him."--What I understand by 'uniform' I would explain by means of examples. 320

Page 17

18. Here definitions are no help to me. 321

Page 17

19. Paraphrasing the rule only makes it more intelligible to someone who can already obey the paraphrase. 321

Page 17

20. Teaching someone to multiply: we reject different patterns of multiplication with the same initial segment. 322

Page 17

21. It would be nonsense to say: just once in the history of the world, someone followed a rule.--Disputes do not break out about whether a proceeding has been according to a rule or not.--This belongs to the structure from which our language goes out to give a description, for example. 322

Page 17

22. As if we had hardened an empirical proposition into a rule and now experience is compared with it and it is used to judge experience. 324

Page 17

23. In calculating everything depends on whether one calculates right or wrong.--The arithmetical proposition is withdrawn from experiential checking. 324

Page 17

24. "If I follow the rule, then this is the only number I can get to from that one." That is how I proceed; don't ask for a reason! 326

Page 17

25. Suppose someone were to work out the multiplication tables, log tables, etc., because he didn't trust them?--Does it make any difference whether we utter a sentence of a calculus as a proposition of arithmetic or an empirical proposition? 327

Page 17

26. "According to the rule that *I* see in this sequence, *this* is how it continues." Not: according to experience! Rather, that just is the sense of the rule. 327

Page Break 18

Page 18

27. When I see a rule in the series--can this consist in my seeing an algebraic expression before me? Must it not belong to a language? 328

Page 18

28. The certainty with which I call the colour "red" is not to be called in question when I give the description. For this characterises what we call describing.--Following according to a rule is the *bottom* of our language-game. Because *this* (e.g., $25^2 = 625$) is the proceeding upon which we build all judging. 329

Page 18

29. Law, and the empirical proposition that we give this law.--"If I obey the order, I do *this*!" does not mean: If I obey the order, I obey the order. So I must have a different way of identifying the "this." 330

Page 18

30. If humans who have been educated in this fashion calculate like this anyway, then what do we need the rule for? "25² = 625" does not mean that human beings calculate like this, for $25^2 \neq 625$ would not be the proposition that humans get not this but a different result.

"Apply the rule to those numbers."--If I want to follow it, have I any choice left? 332

Page 18

31. How far is it possible to describe the function of a rule?

If you aren't master of any rule, all I can do is train you.

But how can I explain the nature of the rule to myself? 333

Page 18

32. What surrounding is requisite for someone to be able to invent chess (e.g.)? Is regularity possible *without* repetition? Not: how often must he have calculated right to prove to *others* that he can calculate, but: how often, to prove it to himself? 334

Page 18

33. Can we imagine someone's knowing that he can calculate although he has never done any calculating? 335

Page Break 19

Page 19

34. In order to describe the phenomenon of language, one has to describe a practice.

A country that exists for two minutes, and is a projection of part of England, with everything that is going on in two minutes. Someone is doing the same as a mathematician in England, who is calculating. In this two-minute-man calculating? 335

Page 19

35. How do I know that the name of this colour is "green"? If I asked other people and they did not agree with me, I should become totally confused and take them or myself for crazy. Here I react with this word ("green"); and *that* is also how I know how I have to follow the rule now.

How a polygon of forces gets drawn according to the given arrows. 336

Page 19

36. "The word OBEN has four sounds."--Is someone who counts the letters making an experiment? It may be one.

Compare: (1) The word there has 7 sounds

(2) The sound-picture "Dædalus" has 7 sounds.

The second proposition is tenseless. The employment of the two propositions must be different.

"By counting off the sounds one may obtain an empirical proposition--or again, a rule".

338

Page 19

37. Definitions--new ways of belonging together. 340

Page 19

38. "How can one follow a rule?"--Here we misunderstand the facts that stare us in the face.

341

Page 19

39. It is important that the enormous majority of us agree in certain things.

Languages of different tribes who all had the same vocabulary, but the meanings of the words were different.--In order to communicate the people would have to agree about meanings--they would have to agree not merely about definitions, but also in their judgments.

342

Page 19

40. The temptation to say "I can't understand language-game (2)

Page Break 20

because the explanation consists only in examples of the application." 343

Page 20

41. A cave-man who produces regular sequences of signs for himself. We do not say that he is acting according to a rule because we can form the general expression of such a rule.

344

Page 20

42. Under what kind of circumstances should we say: someone is giving a rule by drawing this figure? Under what kind of circumstances: that someone is following this rule, when he draws a series of such figures?

345

Page 20

43. Only within a particular technique of acting, speaking, thinking can anyone resolve upon something. (This "can" is the "can" of grammar.)

345

Page 20

44. Two procedures: (1) deriving number after number in sequence according to an algebraic expression; (2) this procedure: as he looks at a certain sign, someone has a digit occur to him; when he looks again at the sign and the digit, again a digit occurs to him, and so on. Acting according to a rule presupposes some kind of *uniformity*.

347

Page 20

45. Instruction in acting according to a rule. The effect of "and so on" will be that we almost all count and calculate the same. It only makes sense to say "and so on" when the other continues in the same way as I.

348

Page 20

46. If something *must* come out, then it is a ground of judgment that I do not assail. 350

Page 20

47. Is it not enough that this certainty exists? Why should I seek a source for it? 350

Page 20

48. As we use the word "order" and "obey", gestures in less than

Page Break 21

words are engulfed in a set of many relationships. In a strange tribe, is the man whom the rest obey unconditionally the chief?--What is the difference between making a wrong inference and not inferring at all?

351

Page 21

49. "That logic belongs to the natural history of mankind"--is not combinable with the logical 'must.'" The agreement of human beings which is a presupposition of the phenomenon of logic, is not an agreement in *opinions*, much less in opinions about questions of logic. 352

PART VII

Page 21

1. The role of propositions that treat of measures and are not empirical propositions. Such a proposition (e.g. 12 inches = 1 foot) is embedded in a technique, and so in the conditions of this technique; but it is not a statement of those conditions. 355

Page 21

2. The role of a rule. It can also be used to make predictions. This depends on properties of the measuring rods and of the people who use them. 355

Page 21

3. A mathematical proposition--a transformation of the expression. The rule considered from the point of view of usefulness and from that of dignity. How are two arithmetical expressions supposed to say the same thing? They are made equivalent in arithmetic. 357

Page 21

4. Someone who learns arithmetic simply by following my examples. If I say, "If you do with these numbers what I did for you with the others, you will get such-and-such a result"--this seems to be both a prediction and a mathematical proposition. 359

Page 21

5. The difference between being surprised that the figures on paper

Page Break 22

seem to behave like *this* and being surprised that *this* is what comes out. 361

Page 22

6. Isn't the contrast between rules of representation and descriptive propositions one which falls away on every side? 363

Page 22

7. What is common to a mathematical proposition and a mathematical proof, that they should both be called "mathematical"? 364

Page 22

8. If we regard proving as the transformation of a proposition by an experiment, and the man who does the calculation as an apparatus, then the intermediate steps are an uninteresting by-product. 364

Page 22

9. Proof as a picture. It is not approval alone which makes this picture into a calculation, but the consensus of approvals. 365

Page 22

10. Does the sense of the proposition change when a proof has been found? The new proof gives the proposition a place in a new system. 366

Page 22

11. Let us say we have got some of our results because of a hidden contradiction. Does that make them illegitimate? Might we not let a contradiction stand? 369

Page 22

12. "A method for avoiding a contradiction mechanically." It is not bad mathematics that is amended here, but a new bit of mathematics is invented. 371

Page 22

13. Must logical axioms always be convincing? 372

Page 22

14. The people who sometimes cancel out by expressions of value 0. 373

Page 22

15. If the calculation has lost its point for me, as soon as I know that

Page Break 23

I can get any arbitrary result from it--did it have no point as long as I did *not* know this?

One thinks that contradiction *has* to be senseless. 374

Page 23	16. What does mathematics need a foundation for? A good angel will always be necessary.	378
Page 23	17. The practical value of calculating. Calculation and experiment. A calculation as part of the technique of an experiment. The activity of calculating may also be an experiment.	379
Page 23	18. Is mathematics supposed to bring facts to light? Does it not take mathematics to determine the character of what we call a 'fact'? Doesn't it teach us how to enquire after facts? In mathematics there are no causal connexions, only the connexions of the pattern.	381
Page 23	19. Remarks.	383
Page 23	20. The network of joins in a wall. Why do we call this a mathematical problem? Does mathematics make experiments with <i>units</i> ?	384
Page 23	21. "The proposition that says of itself that it is unprovable"--how is this to be understood?	385
Page 23	22. The construction of a propositional sign from axioms according to rules; it appears that we have demonstrated the actual sense of the proposition to be false, and at the same time proved it.	387
Page 23	23. The question "How many?" Measurement and unit.	389
Page 23	24. What we call the mathematical conception of a proposition belongs together with the special place calculation has among our other activities.	389
Page Break 24		
Page 24	25. What is the criterion that here I have followed the paradigm?	391
Page 24	26. Anyone who describes learning how to 'proceed according to the rule' for me, will himself be applying the expression of a rule in his description and will presuppose that I understand it.	392
Page 24	27. Not allowing contradiction to stand characterizes the technique of our application of truth-functions--a man's understanding of "and so on" is shown by his saying <i>this</i> and acting <i>thus</i> in certain cases.	393
Page 24	28. Does the "heterological" contradiction shew a logical property of this concept?	395
Page 24	29. A game. And after a certain move any attempt to go on playing proves to be against the rules.	396
Page 24	30. Logical inference is part of a language game. Logical inference and non-logical inference. The rules of logical inference cannot be either wrong or right. They determine the meaning of the signs.	397
Page 24	31. A reasonable procedure with numerals need not be what we call "calculating".	398
Page 24	32. Is not a mathematics with an application that is sheer fantasy, still mathematics?	399
Page 24	33. The formation of concepts may be essential to a great part of mathematics; and have no role in other parts.	399

34. A people who do not notice a contradiction, and draw conclusions from it.
Can it be a mathematical task to make mathematics into mathematics? 400

35. If a contradiction were actually found in arithmetic, this would shew that an arithmetic with such a contradiction can serve us very well. 401

36. "The class of lions is not a lion, but the class of classes is a class." 401

37. "I always lie." What part might this sentence play in human life? 404

38. Logical inference. Is not a rule something arbitrary?
"It is impossible for human beings to recognize an object as different from itself." 404

39. "Correct--i.e. it conforms to the rule." 405

40. "Bringing the *same*"--how can I explain this to someone? 406

41. When should we speak of a proof of the existence of '777' in an expansion? 407

42. "Concept formation" may mean various things.
The concept of a rule for forming an infinite decimal. 408

43. Is it essential to the concept of calculating, that people generally reach this result? 409

44. If I ask, e.g., whether a certain body moves according to the equation of a parabola--what does mathematics do in this case? 410

45. Questions about the way in which mathematics forms concepts. 411

46. Can one not make mathematical experiments after all? 413

47. The pupil has got hold of the rule when he reacts to it in such-and-such a way. This reaction presupposes a surrounding of particular circumstances, forms of life and of language. 413

48. "The line intimates to me how I am to go." 414

49. In some circumstances: the line seems to intimate to him how he is to go, but it isn't a rule. 415

50. How are we to decide if he is always doing the same thing? 415

51. Whether he is doing the same, or a different thing every time--does not yet determine whether he is obeying a rule. 416

52. If you enumerate examples and then say "and so on", this last expression is not explained in the same way as the examples. 416

53. Suppose an inner voice, a sort of inspiration, tells me how to follow the line. What is the difference between this procedure and following a rule? 417

54. Doing the same thing is linked with following a rule. 418

55. Can I play the language-game if I don't have such and such spontaneous reactions? 419

Page 26
56. What we do when following a rule, we see from the point of view of "Always the same thing."
419

Page 26
57. Calculating prodigies who get the right result but can't say how--are we to say they don't calculate?
419

Page 26
58. "Thinking you are following a rule."
420

Page 26
59. How can I explain the word "same"--how do I get the feeling that something lies in my understanding beyond what I can say?
420

Page Break 27

Page 27
60. What is *impalpable* about intimation: there is *nothing* between the rule and my action.
421

Page 27
61. Adding shapes. Possibilities in folding a piece of paper. Suppose we did not separate geometrical and physical possibility?
Might not people in certain circumstances calculate with figures, without a particular result's *having* to come out?
If the calculation shews you a causal connexion, you are not calculating.
Mathematics is normative.
422

Page 27
62. The introduction of a new rule of inference as a transition to a new language game. 425

Page 27
63. Observation that a surface is red and blue, but not that it is red. Inferences from this.
Can logic tell us what we must observe?
425

Page 27
64. A surface with stripes of changing colours.
Could implications be observed?
426

Page 27
65. Someone says he sees a red and yellow star, but not anything yellow. 428

Page 27
66. "I hold to a rule."
429

Page 27
67. The mathematical *must*--the expression of an attitude towards the technique of calculating. The expression of the fact that mathematics forms concepts.
430

Page 27
68. The case of seeing the complex formed from A and B, but seeing neither A nor B.
Can I see A and B, but only observe $A \vee B$?
And *vice versa*.
431

Page 27
69. Experiences and timeless propositions.
432

Page Break 28

Page 28
70. In what sense can a proposition of arithmetic be said to give us a concept? 432

Page 28
71. Not every language-game contains something that we want to call a "concept". 433

Page 28
72. Proof and picture.
434

Page 28
73. A language-game in which there are axioms, proofs and proved propositions. 435

Page 28
74. Any proof in applied mathematics can be regarded as a proof in pure mathematics proving that *this* proposition can be got from *these* propositions by such and such operations--Any empirical proposition can serve as a rule if it

Page Break 29

EDITORS' PREFACE TO THE REVISED EDITION

Page 29

THE posthumously published writings of Wittgenstein which first appeared in 1956 with the title "Remarks on the Foundations of Mathematics" almost all take their origin from the period September 1937-April 1944. Wittgenstein did not return to this subject matter in the last years of his life. On the other hand, he wrote a great deal on the philosophy of mathematics and logic from 1929 to about 1934. A considerable part of this--together with other material from these years--has been published under the titles "Philosophische Bemerkungen" (1964) and "Philosophische Grammatik" (1969).

Page 29

The present revised edition of the "Remarks on the Foundations of Mathematics" contains the *whole* text of the first (1956) edition. In editing it we have thus left out nothing that was already in print. On the other hand, we have included additional material. Only Parts II and III of the first edition are here reprinted, practically unaltered, as Parts III and IV.

Page 29

We have taken the second Appendix to Part I of the first edition, enlarged by a few additions from the MSS, and placed it as an independent Part II of this edition.

Page 29

Part VI of the present edition is entirely new. The MS includes perhaps the most satisfactory presentation of Wittgenstein's thoughts on the problem of following a rule--one of his most frequently recurring themes. The MS (164) was written in the period 1941-1944; we have not been able to date it more precisely.†1 With the exception of a few remarks at the end, which do not quite fit in with the circle of problems that are otherwise the topic of the MS, it is here printed *in extenso*.

Page 29

Part I is the earliest of this collection and to a certain extent it has a peculiar position. It is the only part that existed in typescript and is the most worked over of them all. The typescript itself goes back to manuscripts which were composed for the most part in the period from September 1937 to about the end of that year (117, 118, 119). But the remarks on negation form an exception; they stem from a MS belonging to about the turn of the year 1933-1934 (115).

Page 29

In its original form the typescript that is the basis for Part I formed

Page Break 30

the second half of an earlier version of "Philosophical Investigations". Wittgenstein then split up this half of that version into clippings, supplied them with extensive alterations and additions, and only then constructed that order of the individual remarks that is reproduced here. In a notebook as late as 1944 he proposed a few alterations to this typescript. (See p. 80, n.)

Page 30

The last section of the rearranged collection consisted of papers that had not been cut up, though there were many manuscript additions, and it is not quite clear whether Wittgenstein regarded them as belonging with the preceding text. This section deals with the concept of negation, and as we have already mentioned, it was written 3-4 years earlier than the remainder of Part I. Its content occurs in great part in the "Investigations" §§ 547-568. The editors left it out of the first edition, but have included it here as Appendix I to Part I.

Page 30

The collection had two further appendices. They come from the same typescript as the second half of the (earlier) "Investigations"; nevertheless they were separated from the rest of the collection of clippings. The first deals with 'mathematical surprise'. The second discusses among other things Gödel's theories of the existence of unprovable but true propositions in the system of "Principia Mathematica." In the first edition we included only the second appendix, but here both are published (Appendices II and III.)

Page 30

With the exception of a few remarks which Wittgenstein himself had left out in the arrangement of the clippings, what is here published as Part I comprises the whole content of the second half of the early version of "Philosophical Investigations."

It must have been Wittgenstein's intention also to attach appendices on Cantor's theory of infinity and Russell's logic to the contributions on problems of the foundations of mathematics that he planned to include in the "Philosophical Investigations." Under the heading 'Additions' he wrote a certain amount on the problems connected with set theory: about the diagonal procedure and the different kinds of number-concept. In the time from April 1938 to January 1939 he wrote a MS book where, together with other remarks on the philosophy of psychological concepts, he put in a good deal on probability and truth (Gödel) and also on infinity and kinds of number (Cantor). These writings he immediately continued in a notebook (162a and the beginning of 162b). In the later war-years too he occasionally comes back to these topics. The confrontation with Cantor was never brought to a terminus.

What is here published as Part II consists of the above-mentioned "Additions" in 117 and of a selection of remarks from 121. The whole presents an inconsiderable expansion of Appendix II of Part I of the earlier (1956) edition. The arrangement of sentences and paragraphs into numbered Remarks corresponds to the original text (which was not wholly the case in the 1956 edition). The sections have been numbered by the editors.

Wittgenstein's confrontation with Russell, that is to say with the thought of the derivability of mathematics from the calculi of logic, is found in Part III of this collection (Part II of the edition of 1956). These writings stem from the period from October 1939 to April 1940. The MS (122, continued in the second half of 117) was the most extensive of all the MSS which form the basis of this collection. Neither in style nor in content has it been perfected. The author keeps on renewing the attempt to elucidate his thoughts on the nature of mathematical proof: what it means, for example, to say that a proof must be surveyable; that it presents us with a new picture; that it creates a new concept; and the like. His effort is to declare "the motley of mathematics" and to make clear the connexion between the different techniques of calculation. In so striving he simultaneously sets his face against the idea of a "foundation" of mathematics, whether in the form of a Russellian calculus or in that of the Hilbertian conception of a meta-mathematics. The idea of contradiction and of a consistency proof is extensively discussed.

The editors were of the opinion that this manuscript contained a wealth of valuable thoughts as they are nowhere otherwise to be encountered in Wittgenstein's writings. On the other hand it also seemed clear to them that this MS could not be published unabridged. Thus a selection was requisite. The task was difficult, and the editors are not entirely satisfied with the result.

In the autumn of 1940 Wittgenstein began to occupy himself anew with the philosophy of mathematics and wrote something about the question of following a rule. These writings (MS 123) are not published here. In May 1941 the work was taken up again and soon led to investigations from which a considerable selection is published here as Part VII.

The first part of Part VII (§§ 1-23) was mostly written in June 1941. It discusses the relation between mathematical and empirical propositions, between calculation and experiment, treats the concept of contradiction and consistency anew and ends in the neighbourhood of the

Gödelian problem. The second half was written in the spring of 1944. It deals principally with the concept of following a rule, of mathematical proof and logical inference, and with the connexion between proof and concept formation in mathematics. There are here numerous points of contact, on the one side with the manuscripts of the intervening period (Parts IV and V) and with thoughts in the "Philosophical Investigations" on the other. §§ 47-60 essentially form an earlier version of what can now be found in the "Investigations" §§ 209 to 237. The sequence of the remarks is different here; and some have not been taken up into the later version.--Both halves of this Part VII were in the same MS book, which is one of the indications that the author regarded them as belonging together.

Part V is taken from two MSS (126 and 127) belonging to the years 1942 and 1943--while Part IV derives mainly from one MS (125) from the year 1942, with some additions from the two MSS on which Part V is based. Much on these two parts has the character of "preliminary studies" for the second half of Part VII; but they also contain a wealth of material that the author did not use there.

In Part V Wittgenstein discusses topics that connect up with Brouwer and Intuitionism: the law of excluded

middle and mathematical existence; the Dedekind cut and the extensional and intensional way of looking at things in mathematics. In the second half of this part there are remarks on the concept of generality in mathematics and especially on a theme that makes its appearance still more strongly in Part VII: the role of concept-formation and the relation between concept and truth in mathematics.

Page 32

The chronological arrangement of the material has the consequence that one and the same theme is sometimes treated in different places. If Wittgenstein had put his remarks together into a book, he would presumably have avoided many of these repetitions.

Page 32

It must once more be emphasized: Part I and, practically speaking also Part VI, but only these, are complete reproductions of texts of Wittgenstein's. Thus what is here published as Parts II, III, IV, V and VII is a *selection* from extensive MSS. In their preface to the first edition the editors conjectured that it might be desirable later to print what they had omitted. They are still of the same opinion--but also of the opinion that the time has not yet come to print the whole of Wittgenstein's MSS on these and other topics.

Page 32

The editors alone are responsible for the numbering of the selected paragraphs. (Even in Part I.) But the articulation of the writing into

Page Break 33

"remarks"--here separated from one another by larger gaps--is Wittgenstein's own. With a few exceptions we did not want to interfere with the order of the sections. Nevertheless we have sometimes (especially at the end of Part IV and V) brought together material belonging to the same subject matter from different places.

Page 33

The list of contents and the index are meant to help the reader to look over the whole and to make it easier to look things up. We alone are responsible for the thematic articulation of the material indicated in the list of contents.

Page Break 34

Page Break 35

PART I

Circa 1937-1938

Page 35

1. We use the expression: "The steps are determined by the formula...". How is it used?--We may perhaps refer to the fact that people are brought by their education (training) so to use the formula $y = x^2$, that they all work out the same value for y when they substitute the same number for x . Or we may say: "These people are so trained that they all take the same step at the same point when they receive the order 'add 3'". We might express this by saying: for these people the order "add 3" completely determines every step from one number to the next. (In contrast with other people who do not know what they are to do on receiving this order, or who react to it with perfect certainty, but each one in a different way.)

Page 35

On the other hand we can contrast different kinds of formula, and the different kinds of use (different kinds of training) appropriate to them. Then we *call* formulae of a particular kind (with the appropriate methods of use) "formulae which determine a number y for a given value of x ", and formulae of another kind, ones which "do not determine the number y for a given value of x ". ($y = x^2 + 1$ would be of the first kind, $y > x^2 + 1$, $y = x^2 \pm 1$, $y = x^2 + z$ of the second.) The proposition "The formula... determines a number y " will then be a statement about the form of the formulae--and now we must distinguish such a proposition as "The formula which I have written down determines y ", or "Here is a formula which determines y ", from one of the following kind: "The formula, $y = x^2$ determines the number y for a given value of x ". The question "Is the formula written down there one that determines y ?" will then mean the same as "Is what is there a formula of this kind or that?"--but it is not clear off-hand what we are to make of the question "Is $y = x^2$ a formula which determines y for a given value of x ?" One might address this question to a pupil in order to test whether he understands the use of the word "to

Page Break 36

determine"; or it might be a mathematical problem to work out whether there was only one variable on the right-hand side of the formula, as e.g. in the case: $y = (x^2 + z)^2 - z(2x^2 + z)$.

Page 36

2. "The way the formula is meant determines which steps are to be taken." What is the criterion for the way the formula is meant? Presumably the way we always use it, the way we were taught to use it.

We say, for instance, to someone who uses a sign unknown to us: "If by 'x!2' you mean x^2 , then you get this value for y, if you mean $\sqrt{x^2}$, that one".--Now ask yourself: how does one *mean* the one thing or the other by "x!2"?

That will be how meaning it can determine the steps in advance.

3. *How do I know* that in working out the series + 2 I must write

"20004, 20006"

and not

"20004, 20008"?

--(The question: "How do I know that this colour is 'red'?" is similar.)

"But you surely know for example that you must always write the *same* sequence of numbers in the units: 2, 4, 6, 8, 0, 2, 4, etc."--Quite true: the problem must already appear in this sequence, and even in *this* one: 2, 2, 2, 2, etc.--For how do I know that I am to write "2" after the five hundredth "2"? i.e. that 'the same figure' in that place is "2"? And if I know it *in advance*, what use is this knowledge to me later on? I mean: how do I know what to do with this earlier knowledge when the step actually has to be taken?

(If intuition is needed to continue the series + 1, then it is also needed to continue the series + 0.)

Page Break 37

Page 37

"But do you mean to say that the expression '+ 2' leaves you in doubt what you are to do e.g. after 2004?"--No; I answer "2006" without hesitation. But just for that reason it is superfluous to suppose that this was determined earlier on. My having no doubt in face of the question does *not* mean that it has been answered in advance.

"But I surely also know that whatever number I am given I shall be able, straight off and with certainty, to give the next one.--Certainly my dying first is excluded, and a lot of other things too. But my being so certain of being able to go on is naturally very important.--

Page 37

4. "But then what does the peculiar inexorability of mathematics consist in?"--Would not the inexorability with which two follows one and three two be a good example?--But presumably this means: follows in the *series of cardinal numbers*; for in a different series something different follows. And isn't *this* series just *defined* by this sequence?--"Is that supposed to mean that it is equally correct whichever way a person counts, and that anyone can count as he pleases?"--We should presumably not call it "counting" if everyone said the numbers one after the other *anyhow*; but of course it is not simply a question of a name. For what we call "counting" is an important part of our life's activities. Counting and calculating are not--e.g.--simply a pastime. Counting (and that means: counting like *this*) is a technique that is employed daily in the most various operations of our lives. And that is why we learn to count as we do: with endless practice, with merciless exactitude; that is why it is inexorably insisted that we shall all say "two" after "one", "three" after "two" and so on.--But is this counting only a *use*, then; isn't there also some truth corresponding to this sequence?" The *truth* is that counting has proved to pay.--"Then do you want to say that 'being true' means: being usable (or

Page Break 38

useful)?"--No, not that; but that it can't be said of the series of natural numbers--any more than of our language--that it is true, but: that it is usable, and, above all, *it is used*.

Page 38

5. "But doesn't it follow with logical necessity that you get two when you add one to one, and three when you add one to two? and isn't this inexorability the same as that of logical inference?"--Yes! it is the same.--"But isn't there a truth corresponding to logical inference? Isn't it *true* that this follows from that?"--The proposition: "It is true that this follows from that" means simply: this follows from that. And how do we use this proposition?--What would happen if we made a different inference--*how* should we get into conflict with truth?

Page 38

How should we get into conflict with truth, if our footrules were made of very soft rubber instead of wood and steel?--"Well, we shouldn't get to know the correct measurement of the table."--You mean: we should not get, or could not be sure of getting, *that* measurement which we get with our rigid rulers. So if you had measured the table with the elastic rulers and said it measured five feet by our usual way of measuring, you would be wrong; but if you say that it measured five feet by your way of measuring, that is correct.--"But surely that isn't measuring at all!"--It is similar to our measuring and capable, in certain circumstances, of fulfilling 'practical purposes'. (A shopkeeper might

use it to treat different customers differently.)

Page 38

If a ruler expanded to an extraordinary extent when slightly heated, we should say--in normal circumstances--that that made it *unusable*. But we could think of a situation in which this was just what was wanted. I am imagining that we perceive the expansion with the naked eye; and we ascribe the same numerical measure of length to bodies in rooms of different temperatures, if they measure the same by the ruler which to the eye is now longer, now shorter.

Page Break 39

Page 39

It can be said: What is here called "measuring" and "length" and "equal length", is something different from what we call those things. The use of these words is different from ours; but it is *akin* to it; and we too use these words in a variety of ways.

Page 39

6. We must get clear what inferring really consists in: We shall perhaps say it consists in the transition from one assertion to another. But does this mean that inferring is something that takes place when we are making a transition from one assertion to another, and so *before* the second one is uttered--or that inferring consists in making the one assertion follow upon the other, that is, e.g., in uttering it after the other? Misled by the special use of the verb "infer" we readily imagine that inferring is a peculiar activity, a process in the medium of the understanding, as it were a brewing of the vapour out of which the deduction arises. But let's look at what happens here.--There is a transition from one proposition to another *via* other propositions, that is, a chain of inferences; but we don't need to talk about this; for it presupposes another kind of transition, namely that from one link of the chain to the next. Now a process of forming the transition may occur between the links. There is nothing occult about this process; it is a derivation of one sentence from another according to a rule; a comparison of both with some paradigm or other, which represents the schema of the transition; or something of the kind. This may go on on paper, orally, or 'in the head'.--The conclusion may however also be drawn in such a way that the one proposition is uttered after the other, without any such process; or the process may consist merely in our saying "Therefore" or "It follows from this", or something of the kind. We call it a "conclusion" when the inferred proposition *can* in fact be derived from the premise.

Page Break 40

Page 40

7. Now what does it mean to say that one proposition *can* be derived from another by means of a rule? Can't anything be derived from anything by means of *some* rule--or even according to any rule, with a suitable interpretation? What does it mean for me to say e.g.: this number can be got by multiplying these two numbers? This is a rule telling us that we must get this number if we multiply *correctly*; and we can obtain this rule by multiplying the two numbers, or again in a different way (though any procedure that leads to this result might be called 'multiplication'). Now I am said to have multiplied when I have carried out the multiplication 265×463 , and also when I say: "twice four is eight", although here no calculating procedure led to the product (which, however, I could also have *worked out*). And so we also say a conclusion is drawn, where it is not calculated.

Page 40

8. But still, I must only infer what really *follows*!--Is this supposed to mean: only what follows, going by the rules of inference; or is it supposed to mean: only what follows, going by *such* rules of inference as somehow agree with some (sort of) reality? Here what is before our minds in a vague way is that this reality is something very abstract, very general, and very rigid. Logic is a kind of ultra-physics, the description of the 'logical structure' of the world, which we perceive through a kind of ultra-experience (with the understanding e.g.). Here perhaps inferences like the following come to mind: "The stove is smoking, so the chimney is out of order again". (And *that* is how this conclusion is drawn! Not like this: "The stove is smoking, and whenever the stove smokes the chimney is out of order; and so...".)

Page 40

9. What we call 'logical inference' is a transformation of our expression. For example, the translation of one measure into another. One edge of a ruler is marked in inches, the other in centimetres. I

Page Break 41

measure the table in inches and go over to centimetres *on the ruler*.--And of course there is such a thing as right and wrong in passing from one measure to the other; but what is the reality that 'right' accords with here? Presumably a *convention*, or a *use*, and perhaps our practical requirements.

10. "But doesn't e.g. '*fa*' have to follow from ' $(x).fx$ if ' $(x).fx$ ' is meant in the way we mean it?"--And how does *the way* we mean it come out? Doesn't it come out in the constant practice of its use? and perhaps further in certain *gestures*--and similar things.--But it is as if there were also something attached to the word "all", when *we* say it; something with which a different use could not be combined; namely, the *meaning*. "'All' surely means: *all!*" we should like to say, when we have to explain this meaning; and we make a particular gesture and face.

Cut down all these trees!--But don't you understand what '*all*' means? (He had left one standing.) How did he learn what 'all' means? Presumably by practice.--And of course this practice did not only bring it about that he *does this* on receiving the order--it surrounded the word with a whole lot of pictures (visual and others) of which one or another comes up when we hear and speak the word. (And if we are supposed to give an account of what the 'meaning' of the word is, we first pull out *one* from this mass of pictures--and then reject it again as non-essential when we see that now this, now that, picture presents itself, and sometimes none at all.)

One learns the meaning of "all" by learning that '*fa*' follows from ' $(x).fx$ '.--The exercises which drill us in the use of this word, which teach its meaning, always make it natural to rule out any exception.

11. For how do we *learn* to infer? Or don't we learn it?

Does a child know that an affirmative follows from a double negative?--And how does one *shew* him that it does? Presumably by shewing him a process (a double inversion, two turns through 180° and similar things) which he then takes as a picture of negation.

And the meaning of ' $(x).fx$ ' is made clear by our insisting on '*fa*'s following from it.

12. "From '*all*', if it is meant *like this*, *this* must surely follow!"--If it is meant like *what*? Consider how you mean it. Here perhaps a further picture comes to your mind--and that is all you have got.--No, it is not true that it *must*--but it *does* follow: we *perform* this transition.

And we say: If this does not follow, then it simply wouldn't be *all*--and that only shews how we react with words in such a situation.--

13. It strikes us as if something else, something over and above the *use* of the word "all", must have changed if '*fa*' is no longer to follow from ' $(x).fx$ '; something attaching to the word itself.

Isn't this like saying: "If this man were to act differently, his character would have to be different". Now this may mean something in some cases and not in others. We say "behaviour flows from character" and that is how use flows from meaning.

14. This shews you--it might be said--how closely certain gestures, pictures, reactions, are linked with a constantly practised use.

'The picture forces itself on us....' It is very interesting that pictures do *force* themselves on us. And if it were not so, how could

such a sentence as "What's done cannot be undone" mean anything to us?

15. It is important that in our language--our natural language--'all' is a fundamental concept and 'all but one' less fundamental; i.e. there is not a *single* word for it, nor yet a characteristic gesture.

16. The *point* of the word "all" is that it admits no exception.--True, that is the point of its use in our language; but the kinds of use we feel to be the 'point' are connected with the role that such-and-such a use has in our whole life.

17. When we ask what inferring consists in, we hear it said e.g.: "If I have recognized the truth of the propositions..., then I am justified in further writing down..."--In what sense justified? Had I no right to write that

down before?--"Those propositions convince me of the truth of this proposition." But of course that is not what is in question either.--"The mind carries out the special activity of logical inference according to these laws." That is certainly interesting and important; but then, is it true? Does the mind always infer according to *these* laws? And what does the special activity of inferring consist in?--This is why it is necessary to look and see how we carry out inferences in the practice of language; what kind of procedure in the language-game inferring is.

For example: a regulation says "All who are taller than five foot six are to join the ... section". A clerk reads out the men's names and heights. Another allots them to such-and-such sections.--"N.N. five foot nine." "So N.N. to the ... section." That is inference.

Page Break 44

Page 44

18. Now, what do we call 'inferences' in Russell or Euclid? Am I to say: the transitions from one proposition to the next one in the proof? But where is the *passage* to be found?--I say that in Russell one proposition follows from another if the one can be derived from the other according to the position of both in a proof and the appended signs--when we read the book. For reading this book is a game that has to be learnt.

Page 44

19. One is often in the dark about what following and inferring really consists in; what kind of fact, and what kind of procedure, it is. The peculiar use of these verbs suggests to us that following is the existence of a connexion between propositions, which connexion we follow up when we infer. This comes out very instructively in Russell's account (*Principia Mathematica*). That a proposition $\vdash q$ follows from a proposition $\vdash p \supset q.p$ is here a fundamental law of logic:

$$\vdash p \supset q.p. \supset. \vdash q \dagger 1$$

Now this, one says, justifies us in inferring $\vdash q$ from $\vdash p \supset q.p$. But what does 'inferring', the procedure that is now justified, consist in? Surely in this: that in some language-game we utter, write down (etc.), the one proposition as an assertion after the other; and how can the fundamental law justify me in *this*?

Page 44

20. Now Russell wants to say: "*This* is how I am going to infer, and it is *right*". So he means to tell us how he means to infer: this is done by a *rule* of inference. How does it run? That this proposition implies that one?--Presumably that in the proofs in this book a proposition like this is to come after a proposition like this.--But it is supposed to be a fundamental law of logic that it is

Page Break 45

correct to infer in this way!--Then the fundamental law would have to run: "It is correct to infer ... from ..."; and this fundamental law should presumably be self-evident--in which case the rule itself will self-evidently be correct, or justified. "But after all this rule deals with sentences in a book, and that isn't part of logic!"--Quite correct, the rule is really only a piece of information that in this book only *this* transition from one proposition to another will be used (as it were a piece of information in the index); for the correctness of the transition must be evident where it is made; and the expression of the 'fundamental law of logic' is then the *sequence of propositions* itself.

Page 45

21. In his fundamental law Russell seems to be saying of a proposition: "It already follows--all I still have to do is, to infer it". Thus Frege somewhere says that the straight line which connects any two points is really already there before we draw it; and it is the same when we say that the transitions, say in the series + 2, have really already been made before we make them orally or in writing--as it were tracing them.

Page 45

22. One might reply to someone who said this: Here you are using a picture. One *can determine* the transitions which someone is to make in a series, by doing them for him first. E.g. by writing down in another notation the series which he is to write, so that all that remains for him to do is to translate it; or by actually writing it down very faint, and he has to trace it. In the first case we can also say that we don't write down *the* series that he has to write, and so that we do not ourselves make the transitions of that series; but in the second case we shall certainly say that the series which he is to write is already there. We should also say this if we *dictate* what he has to write down, although then we are producing a series of sounds and he a series of

Page Break 46

written signs. It is at any rate a sure way of *determining* the transitions that someone has to make, if we in some sense make them first.--If, therefore, we determine these transitions in a quite different sense, namely, by subjecting

our pupil to such a training as e.g. children get in the multiplication tables and in multiplying, so that all who are so trained do random multiplications (not previously done in the course of being taught) in the same way and with results that agree--if, that is, the transitions which someone is to make on the order 'add 2' are so determined by training that we can predict with certainty how he will go, even when he has never up to now taken *this* step--then it may be natural to us to use this as a picture of the situation: the steps are all already taken and he is just writing them down.

Page 46

23. "But we surely infer this proposition from that because it actually follows! We ascertain that it follows."--We ascertain that what is written here follows from what is written there. And this proposition is being used *temporally*.

Page 46

24. Separate the feelings (gestures) of agreement, from what you *do* with the proof.

Page 46

25. But how about when I ascertain that this pattern of lines:

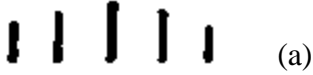

is like-numbered with this pattern of angles:

Page Break 47

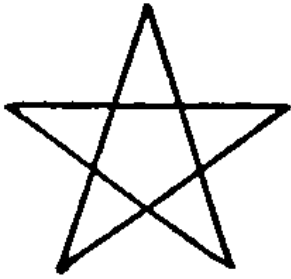

(b)

(I have made the patterns memorable on purpose) by correlating them:

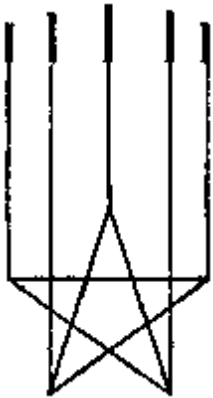

(c)

Page 47

Now what do I ascertain when I look at this figure? What I see is a star with threadlike appendages.--

Page 47

26. But I can make use of the figure like this: five people stand arranged in a pentagon; against the wall are wands, like the strokes in (a); I look at the figure (c) and say: "I can give each of the people a wand".

I could regard figure (c) as a schematic *picture* of my giving the five men a wand each.

Page 47

27. For if I first draw some arbitrary polygon:



Page Break 48

and then some arbitrary series of strokes

|||||

I can find out by correlating them whether I have as many angles in the top figure as strokes in the bottom one. (I do not know how it would turn out.) And so I can also say that by drawing projection-lines I have ascertained that there are as many strokes at the top of figure (c) as the star beneath has points. (Temporally!) In this way of taking it the figure is not like a mathematical proof (any more than it is a mathematical proof when I divide a bag of apples among a group of people and find that each can have just *one* apple).

I can however conceive figure (c) as a mathematical proof. Let us give names to the shapes of the patterns (a) and (b): let (a) be called a "hand", H , and (b) a "pentacle", P . I have proved that H has as many strokes as P has angles. And this proposition is once more non-temporal.

Page 48

28. A proof--I might say--is a *single* pattern, at one end of which are written certain sentences and at the other end a sentence (which we call the 'proved proposition'.)

To describe such a pattern we may say: in it the proposition... follows from.... This is one way of describing a *design*, which might also be for example an ornament (a wallpaper design). I can say, then, "In the proof on that blackboard the proposition p follows from q and r ", and that is simply a description of what can be seen there. But it is not the mathematical proposition that p follows from q and r . That has a different application. It says--as one might put it--that it makes sense to speak of a proof (pattern) in which p follows from q and r . Just as one can say that the proposition "white is lighter than black" asserts that it makes sense to speak of two objects, the lighter one white and the other black, but not of two objects, the lighter one black and the other white.

Page Break 49

Page 49

29. Let us imagine that we had given a paradigm of 'lighter' and 'darker' in the shape of a white and a black patch, and now, so to speak, we use it to deduce that red is darker than white.

Page 49

30. The proposition proved by (c) now serves as a new prescription for ascertaining numerical equality: if one set of objects has been arranged in the form of a hand and another as the angles of a pentacle, we say the two sets are equal in number.

Page 49

31. "But isn't that merely because we have already correlated H and P and seen that they are the same in number?"--Yes, but if they were so in one case, how do I know that they will be so again now?--"Why, because it is of the *essence* of H and P to be the same in number."--But how can you have brought *that* out by correlating them? (I thought the counting or correlation merely yielded the result that these two groups before me were--or were not--the same in number.)

--"But now, if he has an H of things and a P of things, and he actually correlates them, it surely isn't *possible* for him to get any result but that they are the same in number.--And that it is not possible can surely be seen from the proof."--But *isn't* it possible? If, e.g., he--as someone else might say--omits to draw one of the correlating lines. But I admit that in an enormous majority of cases he will always get the same result, and, if he did not get it, would think something had put him out. And if it were not like this the ground would be cut away from under the whole proof. For we decide to use the proof-picture instead of correlating the groups; we do *not* correlate them, but *instead* compare the groups with those of the proof (in which indeed two groups are correlated with one another).

Page Break 50

Page 50

32. I might also say as a result of the proof: "From now on an H and a P are called 'the same in number'".

Or: The proof doesn't *explore* the essence of the two figures, but it does express what I am going to count as belonging to the essence of the figures from now on.--I deposit what belongs to the essence among the paradigms of language.

The mathematician creates *essences*.

Page 50

33. When I say "This proposition follows from that one", that is to accept a rule. The acceptance is *based* on the proof. That is to say, I find this chain (this figure) acceptable as a *proof*.--"But could I do otherwise? Don't I *have* to find it acceptable?"--Why do you say you have to? Because at the end of the proof you say e.g.: "Yes--I have to accept this conclusion". But that is after all only the expression of your unconditional acceptance.

I.e. (I believe): the words "I have to admit this" are used in *two kinds* of case: when we have got a proof--and also with reference to the individual steps of the proof.

34. And how does it come out that the proof *compels* me? Well, in the fact that once I have got it I go ahead in such-and-such a way, and refuse any other path. All I should further say as a final argument against someone who did not want to go that way, would be: "Why, don't you see...!"--and that is no *argument*.

35. "But, if you are right, how does it come about that all men (or at any rate all normal men) accept these patterns as proofs of these propositions?"--It is true, there is great--and interesting--agreement here.

36. Imagine you have a row of marbles, and you number them with Arabic numerals, which run from 1 to 100; then you make a big gap after every 10, and in each 10 a rather smaller gap in the middle with 5 on either side: this makes the 10 stand out clearly as 10; now you take the sets of 10 and put them one below another, and in the middle of the column you make a bigger gap, so that you have five rows above and five below; and now you number the rows from 1 to 10.--We have, so to speak, done drill with the marbles. I can say that we have unfolded properties of the hundred marbles.--But now imagine that this whole process, this experiment with the hundred marbles, were filmed. What I now see on the screen is surely not an experiment, for the picture of an experiment is not itself an experiment.--But I see the 'mathematically essential' thing about the process in the projection too! For here there appear first a hundred spots, and then they are arranged in tens, and so on and so on.

Thus I might say: the proof does not serve as an experiment; but it does serve as the picture of an experiment.

37. Put two apples on a bare table, see that no one comes near them and nothing shakes the table; now put another two apples on the table; now count the apples that are there. You have made an experiment; the result of the counting is probably 4. (We should present the result like this: when, in such-and-such circumstances, one puts first 2 apples and then another 2 on a table, mostly none disappear and none get added.) And analogous experiments can be carried out, with the same result, with all kinds of solid bodies.--This is how our children learn sums; for one makes them put down three beans and then another three beans and then count what is there. If the result at one time were 5, at another 7 (say because, *as we should now say*, one sometimes got added, and one sometimes vanished of itself), then the first thing we said would be that beans were no good for teaching

sums. But if the same thing happened with sticks, fingers, lines and most other things, that would be the end of all sums.

"But shouldn't we then still have $2 + 2 = 4$?"--This sentence would have become unusable.

38. "You only need to look at the figure

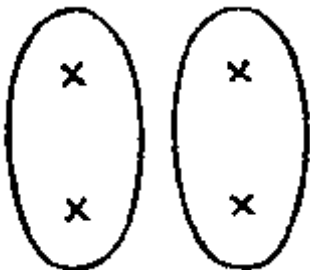

to see that $2 + 2$ are 4."--Then I only need to look at the figure

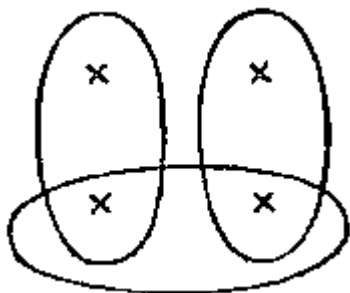

to see that $2 + 2 + 2$ are 4.

39. What do I convince anyone of, if he has followed the film projection of the experiment with the hundred marbles?

One might say, I convince him that it happened like that.--But this would not be a mathematical conviction.--But can't I say: *I impress a procedure on him*? This procedure is the regrouping of 100 things in 10 rows of 10. And this procedure can *as a matter of fact* always be carried out again. And he can rightly be convinced of that.

Page Break 53

Page 53

40. And that is how the proof (25) impresses a procedure on us by drawing projection-lines: the procedure of one-one correlation of the *H* and the *P*.--"But doesn't it also *convince* me of the fact that this †1 correlation is *possible*?"--If that is supposed to mean: you can always carry it out--, then that doesn't have to be true at all. But the drawing of the projection-lines convinces us that there are as many lines above as angles below; and it supplies us with a model to use in correlating such patterns.--"But surely what the model shews in this way is that it does work, not that it did work this time? In the sense in which it wouldn't have worked if the top figure had been ||||| instead of

||||| "How is that? doesn't it work then? Like *this* e.g.:

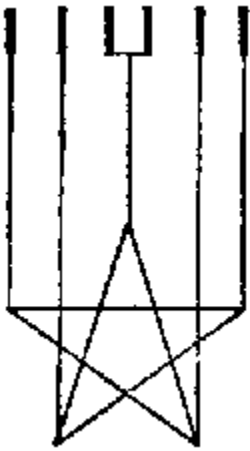

This figure too could be used to prove something. It could be used to shew that groups of these forms *cannot* be given a 1-1 correlation. †2 'A 1-1 correlation is impossible here' means, e.g., "these figures and 1-1 correlation don't fit together."

"I didn't mean it like that"--Then shew me how you mean it, and I'll do it.

But can't I say that the figure shews *how* such a correlation is possible--and mustn't it for that reason also shew *that* it is possible?--

Page Break 54

Page 54

41. Now what was the point of our proposal to attach names to the five parallel strokes and the five-pointed star? What is done by their having got names? It will be a means of indicating something about the kind of use these figures have. Namely--that we recognize them as such-and-such at a glance. To do so, we don't count their strokes or angles; for us they are typical shapes, like knife and fork, like letters and numerals.

Thus, when given the order "Draw an *H*" (for example)--I can produce this shape immediately.--Now the proof teaches me a way of correlating the two shapes. (I should like to say that it is not merely these individual figures that are correlated in the proof, but the *shapes themselves*. But this surely only means that these shapes are well impressed on my mind; are impressed as paradigms.) Now isn't it possible for me to get into difficulties when I want to correlate the shapes *H* and *P*--say by there being an angle too many at the bottom or a stroke too many at the top?--"But surely not, if you have really drawn *H* and *P* again!--And that can be proved; look at this figure."

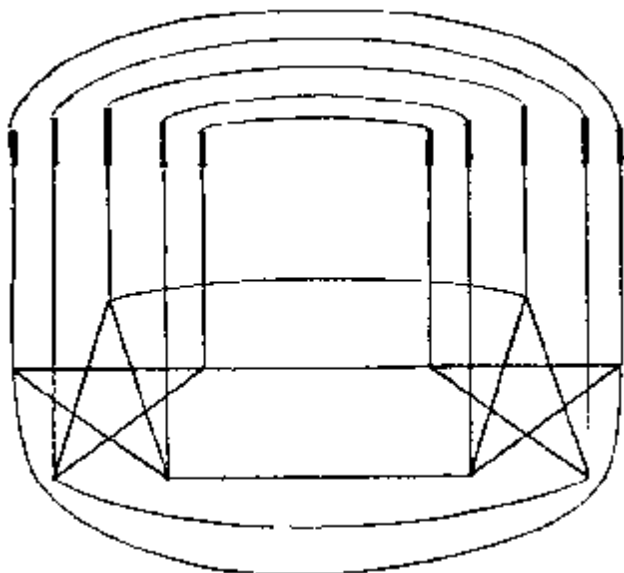

--This figure teaches me a new way of checking whether I have really drawn the same figures; but can't I still get into difficulties when I now want to use this model as a guide? But I say that I am certain I shall

Page Break 55

not normally get into any difficulties.

Page 55

42. There is a puzzle which consists in making a particular figure, e.g. a rectangle, out of given pieces. The division of the figure is such that we find it difficult to discover the right arrangement of the parts. Let it for example be this:

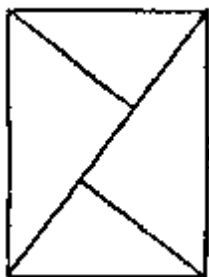

Page 55

What do you discover when you succeed in arranging it?--You discover a position--of which you did not think before.--Very well; but can't we also say: you find out that these triangles can be arranged like this?--But 'these triangles': are they the actual ones in the rectangle above, or are they triangles which have yet to be arranged like that?

Page 55

43. If you say: "I should never have thought that these shapes could be arranged like that", we can't point to the solution of the puzzle and say: "Oh, you didn't think the pieces could be arranged like that?"--You would reply: "I mean, I didn't think of this way of arranging them at all".

Page 55

44. Let us imagine the physical properties of the parts of the puzzle to be such that they can't come into the desired position. Not, however, that one feels a resistance if one tries to put them in this

Page Break 56

position; but one simply tries everything else, only not *this*, and the pieces don't get into this position by accident either. This position is as it were excluded from space. As if there were e.g. a 'blind spot' in our brain here.--And *isn't* it like this when I believe I have tried all *possible* arrangements and have always passed this one by, as if bewitched?

Can't we say: the figure which shews you the solution removes a blindness, or again changes your geometry? It as it were shews you a new dimension of space. (As if a fly were shewn the way out of the fly-bottle.)

Page 56

45. A demon has cast a spell round this position and excluded it from our space.

Page 56

46. The new position has as it were come to be out of nothingness. Where there was nothing, now there suddenly is something.

Page 56

47. In what sense has the solution shewn you that such-and-such can be done? Before, you could *not* do it--and now perhaps you can.--

Page 56

48. I said, "I accept such-and-such as proof of a proposition"--but is it possible for me *not* to accept the figure shewing the arrangement of the pieces as proof that these pieces can be arranged to have this periphery?

Page Break 57

Page 57

49. But now imagine that one of the pieces is lying so as to be the *mirror-image* of the corresponding part of the pattern. Now you want to arrange the figure according to the pattern; you see it must work, but you never hit on the idea of turning the piece over, and you find that you do not succeed in fitting the puzzle together.

Page 57

50. A rectangle can be made of two parallelograms and two triangles. Proof:

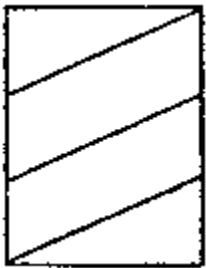

A child would find it difficult to hit on the composition of a rectangle with these parts, and would be surprised by the fact that two sides of the parallelograms make a straight line, when the parallelograms are, after all, askew. It might strike him as if the rectangle came out of these figures by something like magic. True, he has to admit that they do form a rectangle, but it is by a trick, by a distorted arrangement, in an unnatural way.

I can imagine the child, after having put the two parallelograms together in *this* way, not believing his eyes when he sees that they fit like *that*. '*They don't look* as if they fitted together like that.' And I could imagine its being said: It's only through some hocus-pocus that it looks to us as if *they* yielded the rectangle--in reality they have changed their nature, they aren't the parallelograms any more.

Page 57

51. "You admit *this*--then you must admit *this* too."--He *must* admit it--and all the time it is possible that he does not admit it! You want to say: "if he *thinks*, he must admit it".

Page Break 58

Page 58

"I'll shew you why you have to admit it."--I shall bring a case before your eyes which will determine you to judge this way if you think about it.

Page 58

52. Now, how can the manipulations of the proof make him admit anything?

Page 58

53. "Now you will admit that 5 consists of 3 and 2."



I will only admit it, if that is not to admit anything.--Except that I want to use *this picture*.

Page 58

54. One might for example take this figure

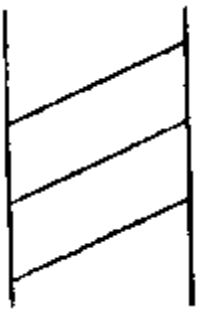

as a proof of the fact that 100 parallelograms arranged like this must yield a straight strip. Then, when one actually does put 100 together, one gets e.g. a slightly curved strip.--But the proof has determined us to use this picture and form of expression: if they don't yield a straight strip, they were not accurately constructed.

Page Break 59

Page 59

55. Just think, how can the picture (or procedure) that you shew me now oblige me always to judge in such-and-such a way?

Page 59

If what we have here is an experiment, then surely *one* is too little to bind me to any judgment.

Page 59

56. The one who is offering the proof says: "Look at this figure. What shall we say about it? Surely that a rectangle consists of...?--"

Or again: "Now, surely you call this a 'parallelogram' and this a 'triangle', and *this* is what it is like for one figure to consist of others".

Page 59

57. "Yes, you have convinced me that a rectangle always consists of..."--Should I also say: "Yes, you have convinced me that *this* rectangle (the one in the proof) consists of..."? For wouldn't this be the more modest proposition, which you ought to grant even if perhaps you don't yet grant the general proposition? But oddly enough if *that* is what you grant, you seem to be granting, not the more modest geometrical proposition, but what is not a proposition of geometry at all. Of course not--for as regards the rectangle in the proof he didn't convince me of anything. (I shouldn't have been in any doubt about this figure, if I had seen it previously.) As far as concerns this figure I acknowledged everything of my own accord. And he merely used it to make me realize something.--But on the other hand, if he didn't convince me of anything as regards this rectangle, then how has he convinced me of a property of other rectangles?

Page 59

58. "True, this shape doesn't look as if it could consist of two skew parts."

What are you surprised at? Surely not at seeing this figure. It is something *in* the figure that surprises me.--But there isn't anything going on in the figure!

Page Break 60

Page 60

What surprises me is the way straight and skew go together. It makes me as it were dizzy.

Page 60

59. But I do actually say: "I have convinced myself that this figure can be constructed with these pieces", e.g. I have seen a picture of the solution of the puzzle.

Now if I say this to somebody it is surely supposed to mean: "Just try: these bits, properly arranged, really do yield the figure". I want to encourage him to do something and I forecast that he will succeed. And the forecast is founded on the ease with which we can construct the figure from the pieces as soon as we know *how*.

Page 60

60. You say you are astonished at what the proof shews you. But are you astonished at its having been possible to draw these lines? No. You are only astonished when you tell yourself that two bits like this *yield* this shape. When, that is, you think yourself into the situation of seeing the result after having expected something different.

Page 60

61. "*This* follows inexorably from *that*."--True, in this demonstration this issues from that.

This is a demonstration for whoever acknowledges it as a demonstration. If anyone *doesn't* acknowledge it, doesn't go by it as a demonstration, then he has parted company with us even before anything is said.



62.

Here we have something that looks inexorable--. And yet it can be 'inexorable' only in its consequences! For otherwise it is nothing but a picture.

What does the action at a distance--as it might be called--of this pattern consist in?

Page 61

63. I have read a proof--and now I am convinced.--What if I straightway forgot this conviction?

For it is a peculiar procedure: I *go through* the proof and then accept its result.--I mean: this is simply what we *do*. This is use and custom among us, or a fact of our natural history.

Page 61

64. 'If I have *five*, then I have *three* and *two*.'--But how do I know that I have five?--Well, if it looks like this: |||||.--And is it also certain that when it looks like *this*, I can always split it up into groups like *those*?

It is a fact that we can play the following game: I teach someone what a group of two, three, four, or five, is like, and I teach him how to put strokes into one-to-one correspondence; then I always make him carry out the order "Draw a group of five" twice--and then I teach him to carry out the order: "Correlate these two groups"; and here it proves that he practically *always* correlates the strokes without remainder.

Or again: it is a fact that I *practically never* get into difficulties in correlating what I have drawn as groups of five.

Page Break 62

Page 62

65. I have to assemble the puzzle, I try it this way and that, am doubtful whether I shall do it. Next someone shows me a picture of the solution, and I say without any sort of doubt--"Now I can do it!"--Then am I *certain* to do it now?--The fact, however, is: I don't have any doubt.

Suppose someone now asked: "What does the action at a distance of the picture consist in?"--In the fact that I apply it.

Page 62

66. *In a demonstration we get agreement* with someone. If we do not, then we've parted ways before ever starting to communicate in this language.

It is not essential that one should talk the other over by means of the demonstration. Both might see it (read it), and accept it.

Page 62

67. "But you can see--there can't be any doubt, that a group like *A* consists essentially of one like *B* and one like *C*."--I too say--i.e.



this is how I too express myself--that the group drawn there consists of the two smaller ones; but I don't know whether every group which I should call the same in kind (or form) as the first will necessarily be composed of two groups of the same kind as the smaller ones.--But I believe that it will probably always be so (perhaps experience has taught me this), and that is why I am willing to accept the rule: I will say that a group is of the form *A* if and only if it can be split up into two groups like *B* and *C*.

Page Break 63

Page 63

68. And this too is how the drawing (50) works as a proof. "True enough! Two parallelograms together do make this shape!" (That is very much as if I were to say: "Actually, a curve can consist of straight bits.")--I shouldn't have thought it. Thought what? That the parts of this figure yield this figure? No, not *that*. For that doesn't mean anything.--My surprise is only when I think of myself unwittingly fitting the top parallelogram on to the bottom one, and then seeing the result.

Page 63

69. And it could be said: What the proof made me realize--*that's* what can surprise me.

Page 63

70. For why do I say that the figure (50) makes me realize something any more than this one:



After all it too shews that two bits like that yield a rectangle. "But that isn't interesting", we want to say. And why is it uninteresting?

Page 63

71. When one says: "This shape consists of these shapes"--one is thinking of the shape as a fine drawing, a fine frame of this shape, on which, as it were, things which have this shape are stretched. (Compare Plato's conception of properties as ingredients of a thing.)

Page Break 64

Page 64

72. "This shape consists of these shapes. You have shewn the essential property of this shape."--You have shewn me a new *picture*.

It is as if *God* had constructed them like that.--*So we are employing a simile*. The *shape* becomes an ethereal entity which has this shape; it is as if it had been constructed like this once for all (by whoever put the essential properties into things). For if the shape is to be a thing consisting of parts, then the pattern-maker who made the shape is he who also made light and dark, colour and hardness, etc. (Imagine someone asking: "The shape... is made up of these parts; who made it? You?")

The word "being" has been used for a sublimed ethereal kind of existence. Now consider the proposition "Red *is*" (e.g.). Of course no one ever uses it; but if I had to invent a use for it all the same, it would be this: as an introductory formula to statements which went on to make use of the word "red". When I pronounce the formula I look at a sample of the colour red.

One is tempted to pronounce a sentence like "red *is*" when one is looking attentively at the colour; that is, in the same *situation* as that in which one observes the existence of a thing (of a leaflike insect, for example).

And I want to say: when one uses the expression, "the proof has taught me--shewn me--that this is the case", one is still using this simile.

Page 64

73. I could also have said: it is not the property of an object that is ever 'essential', but rather the mark of a concept.

Page 64

74. "If the form of the group was the same, then it must have had the same aspects, the same possibilities of division. If it has different ones then it isn't the same form; perhaps it somehow made the same

Page Break 65

impression on you; but it is the *same form* only if you can divide it up in the same way."

It is as if this expressed the essence of form.--I say, however: if you talk about *essence*--, you are merely noting a convention. But here one would like to retort: there is no greater difference than that between a proposition about the depth of the essence and one about--a mere convention. But what if I reply: to the *depth* that we see in the essence there corresponds the *deep* need for the convention.

Thus if I say: "It's as if this proposition expressed the *essence* of form"--I mean: it is as if this proposition expressed a property of the entity *form*!--and one can say: the entity of which it asserts a property, and which I here call the entity 'form', is the picture which I cannot help having when I hear the word "form".

Page 65

75. But what sort of properties of the hundred marbles did you unfold, or display?†1--Well, that these things can be done with them.--But *what* things? Do you mean that you were able to move them about like that, that they weren't glued on to the table top?--Not so much that, as that they have gone into these formations without any loss or addition.--So you have shewn the physical properties of the row. But why did you use the expression "unfolded"? You would not have spoken of unfolding the properties of a bar of iron by shewing that it melts at such

and such a temperature. And mightn't you as well say that you unfolded the properties of our memory for numbers, as the properties of the row (e.g.)? For what you really do *unfold*, or *lay out*, is the row of marbles.--And you shew e.g. that if a row looks thus and thus, or is numbered with roman numerals in this way, it can be brought into that other memorable arrangement in a simple way, and without addition or loss of any marble. But this could after all equally well have been a psychological experiment shewing that you *now* find memorable certain patterns into which 100 spots are made merely by shifting them about.

Page Break 66

Page 66

"I have shewn what can be done with 100 marbles."--You have shewn that *these* 100 marbles (or those marbles over there), can be laid out in this way. The experiment was one of laying out (as opposed say to one of burning).

And the psychological experiment might for example have shewn how easy it is for you to be deceived: i.e. that you don't notice if marbles are smuggled into or out of the row. One could also say *this*: I have shewn what can be made of a row of 100 spots by means of apparent shifts,--what figures can be got out of it by apparent shifts.--But what did I unfold in this case?

Page 66

76. Imagine it were said: we unfold the properties of a polygon by using diagonals to take the sides together three at a time. It then proves to be a figure with 24 angles. Do I want to say I have unfolded a property of the 24-angled polygon? No. I want to say I have unfolded a property of this polygon (the one drawn here). I now know that there is drawn here a figure with 24 angles.

Is this an experiment? It shews me e.g. what kind of polygon is drawn here now. What I did can be called an experiment in counting.

But what if I perform such an experiment on a pentagon, which I can already take in at a glance?--Well, let us assume for a moment that I could not take it in at a glance,--which (e.g.) may be the case if it is very big. Then drawing the diagonals would be a way of finding out that this is a pentagon. I could once more say I had unfolded the properties of the polygon drawn here.--Now if I can take it in at a glance then surely nothing *about it* can be changed. It was, perhaps, superfluous to unfold this property, as it is superfluous to count two apples which are before my eyes.

Page Break 67

Page 67

Ought I to say now: "It was an experiment again, but I was certain of the result"? But am I certain of the result in the way I am certain of the result of the electrolysis of a mass of water? No, but in another way. If the electrolysis of the liquid did not yield..., I should consider myself crazy, or say that I no longer have any idea what to say.

Imagine I were to say: "Yes, here is a square,--but still let's look and see whether a diagonal divides it into two triangles". Then I draw the diagonal and say: "Yes, here we have two triangles". Here I should be asked: Couldn't you *see* that it could be divided into two triangles? Have you only just convinced yourself that there is a square here; and why trust your eyes now rather than before?

Page 67

77. Exercises: Number of notes--the internal property of a tune; number of leaves--the external property of a tree. How is this connected with the identity of the concept? (Ramsey.)

Page 67

78. If someone splits up four marbles into two and two, puts them together again, splits them up again and so on, what is he shewing us? He is impressing on us a physiognomy and a typical alteration of this physiognomy.

Page 67

79. Think of the possible postures of a puppet. Or suppose you had a chain of, say, ten links, and you were shewing what kind of characteristic (i.e. memorable) figures it can be made into. Let the links be numbered; in this way they become an easily memorable structure even when they lie in a straight line.

So I impress characteristic positions and movements of this chain on you.

If I now say: "Look, *this* can be made of it too" and display it, am I shewing you an experiment?--It may be; I am shewing for

Page Break 68

example that it can be got into this shape: but that you didn't doubt. And what interests you is not something to do

with this individual chain.--But all the same isn't what I am displaying a property of this chain? Certainly: but I only display such movements, such transformations, as are of a memorable kind; and it interests you to *learn* these transformations. But the reason why it interests you is that it is so easy to reproduce them again and again in different objects.

Page 68

80. The words "look what I can make with it--" are indeed the same as I should use if I were shewing what I can make with a lump of clay, for example. E.g. that I am clever enough to make such things with this lump. In another case: that this material can be dealt with like *this*. Here I should hardly be said to be 'drawing your attention to' the fact that I can do this, or that the material can stand this;--while in the case of the chain one would say: I draw your attention to the fact that this can be done with it.--For you could also have *imagined* it. But of course you can't get to know any property of the material by imagining.

The experimental character disappears when one looks at the process simply as a memorable picture.

Page 68

81. What I unfold may be said to be the *role* which '100' plays in our calculating system.

Page 68

82. (I once wrote: "In mathematics process and result are equivalent.")† 1

Page Break 69

Page 69

83. And yet I feel that it is a property of '100' that it is, or can be, produced in this way. But then how can it be a property of the structure '100' to be produced in this way, if e.g. it didn't get produced in this way at all? If no one multiplied in this way? Surely only if one could say, it is a property of this sign to be the subject of this rule. For example it is the property of '5' to be the subject of the rule ' $3 + 2 = 5$ '. For only as the subject of the rule is this number *the* result of the addition of the other numbers.

But suppose I now say: it is a property of the number... to be the result of the addition of... according to the rule...?--So it is a property of the number that it arises when we apply this rule to these numbers. The question is: should we call it 'application of the rule', if this number were *not* the result? And that is the same question as: "What do you understand by 'application of this rule': what you e.g. do with it (and you may apply it at one time in this way, at another in that), or is 'its application' otherwise explained?"

Page 69

84. "It is a property of this number that this process leads to it.--"But, mathematically speaking, a process does not lead to it; it is the end of a process (is itself part of the process).

Page 69

85. But why do I feel that a property of the row is unfolded, is shewn?--Because I alternately look at what is shewn as essential and as nonessential to the row. Or again: because I think of these properties alternately as external and as internal. Because I alternately take something as a matter of course and find it noteworthy.

Page 69

86. "You surely unfold the properties of the hundred marbles

Page Break 70

when you shew what can be made of them."--Can be made of them *how*? For, that it *can* be made of them no one has doubted, so the point must be the *kind of way* it is produced from them. But look at that, and see whether it does not perhaps itself presuppose the result.--

For suppose that in *that way* you got one time this and another time a different result; would you accept this? Would you not say: "I must have made a mistake; the *same* kind of way would always have to produce the same result". This shows that you are incorporating the result of the transformation into the kind of way the transforming is done.

Page 70

87. Exercise: am I to call it a fact of experience that *this* face turns into *that* through *this* alteration? (How must '*this* face', '*this* alteration' be explained so as to...?)

Page 70

88. One says: this division *makes it clear* what kind of row of marbles we have here. Does it make it clear what kind of row it *was* before the division, or does it make it clear what kind of row it is now?

Page 70

89. "I can see at a glance how many there are." Well, how many are there? Is the answer "*so* many"?--(pointing to the group of objects). How does the answer go, though? There are '50', or '100', etc.

90. "The division makes it clear to me what kind of row it is." Well, what kind of row is it? Is the answer "*this* kind"? How does a significant answer run?

91. Now I am surely also unfolding the geometrical properties of this chain, if I display the transformations of another, similarly constructed, chain. What I do, however, does not shew what I can in fact do with the first one, if it in fact should prove inflexible or in some other way physically unsuitable.

So after all I cannot say: I unfold the *properties of this chain*.

92. Can one unfold properties of the chain which it doesn't possess at all?

93. I measure a table; it is one yard long.--Now I put one yardstick up against another yardstick. Am I measuring it by doing that? Am I finding out that the second yardstick is a yard long? Am I making the same experiment of measuring, only with the difference that I am certain of the outcome?

94. And when I put the ruler up against the table, am I always measuring the table; am I not sometimes checking the ruler? And in what does the distinction between the one procedure and the other consist?

95. The experiment of laying a row out may shew us, among other things, how many marbles the row consists of, or on the other hand that we can move these (say) 100 marbles in such-and-such ways.

But when we calculate how the row can be laid out, the calculation shews us what we call a 'transformation merely by laying out'.

96. Examine this proposition: it is not an *empirical* *[[sic]]* fact that the tangent of a visual curve partly coincides with the curve; and if a figure shews this, then it does not do so as the result of an experiment.



It could also be said: here you can see that segments of a continuous visual curve are straight.--But ought I not to have said:--"Now you call this a 'curve'.--And do you call this little bit of it 'curved' or 'straight'?--Surely you call it a 'straight line'; and the curve contains this bit."

But why should one not use a new name for visual stretches of a curve which themselves exhibit no curvature?

"But the experiment of drawing these lines has shewn that they do not touch at a *point*.--That *they* do not touch at a point? How are '*they*' defined? Or again: can you point to a picture of what it is like for them to 'touch at a point'? Why shouldn't I simply say the experiment has yielded the result that they, i.e. a curved and a straight line, touch one another? For *isn't* this what I call a "touching" of such lines?

97. Let us draw a circle composed of black and white segments getting smaller and smaller.



"Which is the first of these segments--going from left to right--that strikes you as straight?" Here I am making an experiment.

98. What if someone were to say "Experience tells me that this line



is curved"?--Here it would have to be said that the words "this line" mean the line drawn on the paper. The experiment can actually be made, one can show this line to different people and ask: "What do you see, a straight line or a curved one?"--

But suppose someone were to say: "I am now imagining a curved line", whereupon we tell him: "So you see that the line is a curved one"--what kind of sense would that make?

One can however also say: "I am imagining a circle made of black and white segments; one is big and curved, the ones that come after it keep on getting smaller, the sixth is quite straight". Where is the experiment here?

I can *calculate* in the medium of imagination, but not experiment.

Page 73

99. What is the characteristic use of the derivation procedure as a *calculation*--as opposed to its use as an experiment?

We regard the calculation as demonstrating an *internal property* (a property of the *essence*) of the structures. But what does that mean?

The following might serve as a model of an 'internal property':

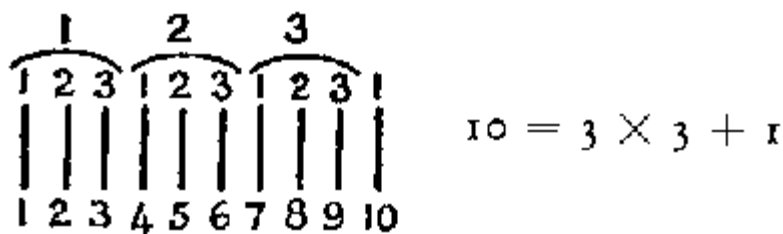

$$10 = 3 \times 3 + 1$$

Now when I say: 10 strokes necessarily consist of 3 times 3 strokes and 1 stroke--that does not mean: if there are 10 strokes there, then

Page Break 74

they have always got these figures and loops round them.--But if I put them in, I say that I was only demonstrating the nature of the group of strokes.--But are you certain that the group did not change while you were writing those symbols in?--"I don't know; but *a* definite number of strokes was there; and if it was not 10 then it was another number, and in that case it simply had different properties.--"

Page 74

100. One says: calculation 'unfolds' the property of a hundred.--What does it really mean to say that 100 consists of 50 and 50? One says: the contents of the box consist of 50 apples and 50 pears. But if someone were to say: "The contents of the box consist of 50 apples and 50 apples"--, to begin with we shouldn't know what he meant.--If one says: "The contents of the box consist of twice 50 apples", this means either that there are two compartments each containing 50 apples; or what is in question is, say, a distribution in which each person is supposed to get 50 apples, and now I hear that two people can be given their share out of this box.

Page 74

101. "The 100 apples in this box consist of 50 and 50"--here the non-temporal character of 'consist' is important. For it doesn't mean that *now*, or just for a time, they consist of 50 and 50.

Page 74

102. For what is the characteristic mark of 'internal properties'? That they persist always, unalterably, in the whole that they constitute; as it were independently of any outside happenings. As the construction of a machine on paper does not break when the machine itself succumbs to external forces.--Or again, I should like to say that they are not subject to wind and weather like physical things; rather are they unassailable, like shadows.

Page Break 75

Page 75

103. When we say: "This proposition follows from that one" here again "to follow" is being used *non-temporally*. (And this shews that the proposition does not express the result of an experiment.)

104. Compare "White is lighter than black". This expression too is non-temporal and it too expresses the existence of an *internal* relation.

105. "But this relation *holds*"--one would like to say. The question is: has this proposition a use--and what use? For at the moment all I know is that a picture comes before my mind as I say it (but that does not guarantee the use for me) and that the words form an English sentence. But it sticks out that the words are being used otherwise here than in the everyday case of a useful statement. (As, say, a wheelwright may notice that the statements that he ordinarily makes about what is circular and straight are of a different kind from what are to be found in Euclid.) For we say: this *object* is lighter than that one, or the colour of this thing is lighter than the colour of that one, and in this case something is lighter now and may be darker later on.

Whence comes the feeling that "white is lighter than black" expresses something about the *essence* of the two colours?--

But is this the right question to ask? For what do we mean by the 'essence' of white or black? We think perhaps of 'the inside', 'the constitution', but this surely makes no sense here. We also say e.g.: "It is part of white to be lighter than...".

Is it not like this: the picture of a black and a white patch



serves us *simultaneously* as a paradigm of what we understand by "lighter"

and "darker" and as a paradigm for "white" and for "black". Now darkness 'is part of black *inasmuch as* they are *both* represented by this patch. It is dark *by* being black.--But to put it better: it *is called* "black" and hence in our language "dark" too. That connexion, a connexion of the paradigms and the names, is set up in our language. And our proposition is non-temporal because it only expresses the connexion of the words "white", "black" and "lighter" with a paradigm.

Misunderstandings can be avoided by declaring it nonsense to say: "the colour of this body is brighter than the colour of that one"; what would have to be said is "this body is brighter than that one". I.e. the former way of putting it is excluded from our language.

Whom do we tell "White is lighter than black"? What information does it give?

106. But can't I believe the geometrical proposition even without a proof, for example on someone else's assurance?--And what does the proposition lose in losing its proof?--Here I presumably ought to ask: "What can I do with it?", for that is the point. *Accepting* the proposition on someone else's assurance--how does my doing this come out? I may for example use it in further calculating operations, or I use it in judging some physical fact. If someone assures me, for example, that 13×13 are 196 and I believe him, then I shall be surprised that I can't arrange 196 nuts in 13 rows of 13 each, and I shall perhaps assume that the nuts have increased of themselves.

But I feel a temptation to say: one can't *believe* that $13 \times 13 = 196$, one can only *accept* this number mechanically from somebody else. But why should I not say I believe it? For is believing it a mysterious act with as it were an underground connexion with the correct calculation? At any rate I can *say*: "I believe it", and act accordingly.

One would like to ask: "What are you doing in believing that $13 \times 13 = 196$?" And the answer may be: Well, that will depend on whether, for instance, you did the sum and made a slip of the pen in doing so,--or whether somebody else did it, but you yourself know how such a calculation is done,--or whether you cannot multiply but know that the product is the number of people to be found in 13 rows of 13 each,--in short it depends on what you can do with the equation $13 \times 13 = 196$. For testing it is doing something with it.

107. The thing is, if one thinks of an arithmetical equation as the expression of an internal relation, then one would like to say: "You can't believe at all that 13×13 yields *this*, because that isn't a multiplication of 13 by 13, or is not a case of something *yielded*, if 196 comes at the end." But that means that one is not willing to use the word "believe" for the case of a calculation and its result,--or is willing only in the case in which one has a correct

calculation before one.

Page 77

108. "What are you believing if you believe $13 \times 13 = 196$?--"How deep do you penetrate, one might say, with your belief, into the relation of these numbers? For--one wants to say--you cannot be penetrating all the way, or you could not believe it.

But when have you penetrated into the relations of the numbers? Just while you say that you believe...? You will not take your stand on that--for it is easy to see that this appearance is merely produced by the superficial form of our grammar (as it might be called).

Page 77

109. For I want to say: "One can only *see* that $13 \times 13 = 169$, and even that one can't *believe*. And one can--more or less blindly--accept a rule". And what am I doing if I say this? I am *drawing a line* between

Page Break 78

the *calculation* with its result (that is to say a particular picture, a particular model), and an experiment with its outcome.

Page 78

110. I should like to say: "When I believe that $a \times b = c$ --and I do sometimes have such beliefs--do say that I have them--I am not believing the mathematical proposition, for that comes at the end of a proof, is the end of a proof; I am believing that this is the formula that comes in such-and-such a place, which I shall obtain in such-and-such a way, and so on".--And this does sound as if I were penetrating the process of believing such a proposition. Whereas I am merely--in an unskilful fashion--pointing to the *fundamental* difference, together with an apparent similarity, between the roles of an arithmetical proposition and an empirical proposition.

For in certain circumstances I do *say*: "I believe that $a \times b = c$ ". What do I *mean* by this?--What I *say*!--But what *is* interesting is the question in what circumstances I say this and what is characteristic of them in contrast to those of a statement like: "I believe it is going to rain". For what preoccupies us is this contrast. What we require is a picture of the employment of mathematical propositions and of sentences beginning "I believe that...", where a mathematical proposition is the object of belief.

Page 78

111. "But you surely don't believe a mathematical proposition."--That means: 'Mathematical proposition' signifies a role for the proposition, a function, in which believing does not occur.

Compare: "If you say: 'I believe that castling takes place in such and such a way', then you are not believing the rule of chess, but believing e.g. that a rule of chess runs like *that*".

Page Break 79

Page 79

112. "One can't *believe* that the multiplication 13×13 yields 169, because the result is part of the calculation."--What am I calling "the multiplication 13×13 "? Only the correct pattern of multiplication, at the end of which comes 169? Or a 'wrong multiplication' too?

How is it established which pattern is the multiplication 13×13 ?--Isn't it *defined* by the rules of multiplication?--But what if, using these rules, you get different results today from what all the arithmetic books say? Isn't that possible?--"Not if you apply the rules as *they* do!" Of course not! But that is a mere pleonasm. And where does it say how they are to be applied--and if it does say somewhere, where does it say how *that* is to be applied? And that does not mean only: in what book does it say, but also: in what *head*?--What then is the multiplication 13×13 --or what am I to take as a guide in multiplying--the rules, or the multiplication that comes in the arithmetic books--if, that is, these two do not agree?--Well, it never in fact happens that somebody who has learnt to calculate goes on obstinately getting different results, when he does a given multiplication, from what comes in the arithmetic books. But if it should happen, then we should declare him abnormal, and take no further account of his calculation.

Page 79

113. "But am I not compelled, then, to go the way I do in a chain of inferences?"--Compelled? After all I can presumably go as I choose!--"But if you want to remain in accord with the rules you *must* go this way."--Not at all, I call *this* 'accord'.--"Then you have changed the meaning of the word 'accord', or the meaning of the rule."--No;--who says what 'change' and 'remaining the same' mean here?

However many rules you give me--I give a rule which justifies *my* employment of your rules.

Page Break 80

Page 80

114. We might also say: when we *follow* the laws of inference (inference-rules) then following always

involves interpretation too.

Page 80

115. "But you surely can't suddenly make a different application of the law now!"--If my reply is: "Oh yes of course, *that* is how I was applying it!" or: "Oh! *That's* how I ought to have applied it--!"; then I am playing your game. But if I simply reply: "Different?--But this surely *isn't* different!"--what will you do? That is: somebody may reply like a rational person and yet not be playing our game.†1

Page 80

116. "Then according to you everybody could continue the series as he likes; and so infer *anyhow!*" In that case we shan't call it "continuing the series" and also presumably not "inference". And thinking and inferring (like counting) is of course bounded for us, not by an arbitrary definition, but by natural limits corresponding to the body of what can be called the role of thinking and inferring in our life.

For we are at one over this, that the laws of inference do not compel him to say or to write such and such like rails compelling a locomotive. And if you say that, while he may indeed *say* it, still he can't *think* it, then I am only saying that that means, not: try as he may he can't think it, but: it is for us an essential part of 'thinking' that--in talking, writing, etc.--he makes *this sort* of transition. And I say further that the line between what we include in 'thinking' and what we no longer include in 'thinking' is no more a hard and fast one than the line between what is still and what is no longer called "regularity".

Nevertheless the laws of inference can be said to compel us; in the

Page Break 81

same sense, that is to say, as other laws in human society. The clerk who infers as in (17) *must* do it like that; he would be punished if he inferred differently. If you draw different conclusions you do indeed get into conflict, e.g. with society; and also with other practical consequences.

And there is even something in saying: he can't *think* it. One is trying e.g. to say: he can't fill it with personal content; he can't really *go along with it*--personally, with his intelligence. It is like when one says: this sequence of notes makes no sense, I can't sing it with expression. I cannot *respond* to it. Or, what comes to the same thing here: I don't respond to it.

"If he says it"--one might say--"he can only say it without thinking". And here it merely needs to be noticed that 'thoughtless' talk and other talk do indeed sometimes differ as regards what goes on in the talker, his images, sensations and so on while he is talking, but that this accompaniment does not constitute the thinking, and the lack of it is not enough to constitute 'thoughtlessness'.

Page 81

117. In what sense is logical argument a compulsion?--"After all you grant *this* and *this*; so you must also grant *this!*" That is the way of compelling someone. That is to say, one can in fact compel people to admit something in this way.--Just as one can e.g. compel someone to go over there by pointing over there with a bidding gesture of the hand.

Suppose in such a case I point with two fingers at once in different directions, thus leaving it open to the man to go in which of the two directions he likes,--and another time I point in only *one* direction; then this can also be expressed by saying: my first order did not compel him to go just in *one* direction, while the second one did. But this is a statement to tell us what kind of orders I gave; not the way they operate, not whether they do in fact compel such-and-such a person, i.e. whether he obeys them.

Page Break 82

Page 82

118. It looked at first as if these considerations were meant to shew that 'what seems to be a logical compulsion is in reality only a psychological one'--only here the question arose: am I acquainted with both kinds of compulsion, then?!

Imagine that people used the expression: "The law §... punishes a murderer with death". Now this could only mean: this law runs so and so. That form of expression, however, might force itself on us, because the law is an instrument when the guilty man is brought to punishment.--Now we talk of 'inexorability' in connexion with people who punish. And here it might occur to us to say: "The law is *inexorable*--men can let the guilty go, the law executes him". (And even: "the law *always* executes him".)--What is the use of such a form of expression?--In the first instance, this proposition only says that such-and-such is to be found in the law, and human beings sometimes do not go by the law. Then, however, it does give us a picture of a single inexorable judge, and many lax judges. That is why it serves to express respect for the law. Finally, the expression can also be so used that a law is called inexorable when it makes no provision for a possible act of grace, and in the opposite case it is perhaps called 'discriminating'.

Now we talk of the 'inexorability' of logic; and think of the laws of logic as inexorable, still more inexorable than the laws of nature. We now draw attention to the fact that the word "inexorable" is used in a variety of ways. There correspond to our laws of logic very general facts of daily experience. They are the ones that make it possible for us to keep on demonstrating those laws in a very simple way (with ink on paper for example). They are to be compared with the facts that make measurement with a yardstick easy and useful. This suggests the use of precisely these laws of inference, and now it is *we* that are inexorable in applying these laws. Because we '*measure*'; and it is part of measuring for everybody to have the same measures. Besides this, however, inexorable, i.e. *unambiguous* rules of inference can be distinguished from ones that are not unambiguous, I mean from such as leave an alternative open to us.

Page Break 83

Page 83

119. "But I can infer only what actually does follow."--That is to say: what the logical machine really does produce. The logical machine--that would be an all-pervading ethereal mechanism.--We must give warning against this picture.

Imagine a material harder and more rigid than any other. But if a rod made of this stuff is brought out of the horizontal into the vertical, it shrinks; or it bends when set upright and at the same time it is so hard that there is no other way of bending it.--(A mechanism made of this stuff, say a crank, connecting-rod and crosshead. The different way the crosshead would move.)

Or again: a rod bends if one brings a certain mass near it; but it is completely rigid in face of all forces that we subject it to. Imagine that the guide-rails of the crosshead bend and then straighten again as the crank approaches and retreats. My assumption would be, however, that no particular external force is necessary to cause this. This behaviour of the rails would give an impression as of something alive.

When we say: "If the parts of the mechanism were quite rigid, they would move so and so", what is the criterion for their being quite rigid? Is it that they resist certain forces? Or that they do move so and so?

Suppose I say: "This is the law of motion of the crosshead (the correlation of its position and the position of the crank perhaps) when the lengths of the crank and connecting-rod remain constant". This presumably means: If the crank and crosshead keep these relative positions, I say that the length of the connecting-rod remains constant.

Page 83

120. "If the parts were perfectly rigid this is how they would move"; is that a hypothesis? It seems not. For when we say: "Kinematics describes the movements of the mechanism on the assumption that its parts are completely rigid", on the one hand we are admitting that this assumption never squares with reality, and on the other hand it

Page Break 84

is not supposed to be in any way doubtful that completely rigid parts would move in this way. But whence this certainty? The question here is not really one of certainty but of something stipulated by us. We do not *know* that bodies would move in these ways if (by such and such criteria) they were quite rigid; but (in certain circumstances) we should certainly *call* 'rigid' such parts as did move in those ways.--Always remember in such a case that geometry (or kinematics) does not specify any method of measuring when it talks about the same, or constant, length.

When therefore we call kinematics the theory, say, of the movement of perfectly rigid parts of a mechanism, on the one hand this contains an indication as to (mathematical) method--we stipulate certain distances as the lengths of machine parts that do not alter--and on the other hand an *indication* about the application of the calculus.

Page 84

121. The hardness of the logical *must*. What if one were to say: the *must* of kinematics is much harder than the causal *must* compelling a machine part to move like *this* when another moves like *this*?--

Suppose we represented the movement of the 'perfectly rigid' mechanism by a cinematographic picture, a cartoon film. Suppose this picture were said to be *perfectly hard*, and this meant that we had taken this picture as our method of description--whatever the facts may be, however the parts of the real mechanism may bend or expand.

Page 84

122. The machine (its structure) as symbolizing its action: the action of a machine--I might say at first--seems to be there in it from the start. What does that mean?--

Page 84

If we know the machine, everything else, that is its movement, seems

to be already completely determined.

"We talk as if these parts *could* only move in this way, as if they could not do anything else."

How is this--do we forget the possibility of their bending, breaking off, melting, and so on? Yes; in *many* cases we don't think of that at all. We use a machine, or the picture of a machine, to symbolize a particular action of the machine. For instance, we give someone such a picture and assume that he will derive the movement of the parts from it. (Just as we can give someone a number by telling him that it is the twenty-fifth in the series 1, 4, 9, 16,)

"The machine's action seems to be in it from the start" means: you are inclined to compare the future movements of the machine in definiteness to objects which are already lying in a drawer and which we then take out.

But we do not say this kind of thing when we are concerned with predicting the actual behaviour of a machine. Here we do not in general forget the possibility of a distortion of the parts and so on.

We do talk like that, however, when we are wondering at the way we can use a machine to symbolize a given way of moving--since it can also move in quite *different* ways.

Now, we might say that a machine, or the picture of it, is the first of a series of pictures which we have learnt to derive from this one.

But when we remember that the machine could also have moved differently, it readily seems to us as if the way it moves must be contained in the machine-as-symbol far more determinately than in the actual machine. As if it were not enough here for the movements in question to be empirically determined in advance, but they had to be really--in a mysterious sense--already *present*. And it is quite true: the movement of the machine-as-symbol is predetermined in a different sense from that in which the movement of any given actual machine is predetermined.

123. "It is as if we could grasp the whole use of the word in a flash." Like *what* e.g.?--Can't the use--in a certain sense--be grasped in a flash? And in *what* sense can it not? The point is, that it is as if we could 'grasp it in a flash' in yet another and much more direct sense than that.--But have you a model for this? No. It is just that this expression suggests itself to us. As the result of crossing similes.

124. You have no model of this superlative fact, but you are seduced into using a *super-expression*.

125. When does one have the thought: the possible movements of a machine are already there in it in some mysterious way?--Well, when one is doing philosophy. And what leads us into thinking that? The way we talk about machines. We say, for example, that a machine *has* (*possesses*) such-and-such possibilities of movement; we speak of the ideally rigid machine which *can* only move in such-and-such a way.--What is this *possibility* of movement? It is not the *movement*, but it does not seem to be the mere physical *conditions* for moving either, e.g. that there is a certain space between socket and pin, the pin not fitting too tight in the socket. For while this is the *empirical* condition for movement, one could also imagine it to be otherwise. The possibility of a movement is, rather, supposed to be a shadow of the movement itself. But do you know of such a shadow? And by a shadow I do not mean some picture of the movement; for such a picture would not necessarily be a picture of just *this* movement. But the possibility of this movement must be the possibility of just this movement. (See how high the seas of language run here!)

The waves subside as soon as we ask ourselves: how do we use the

phrase "possibility of movement" when we are talking about a given machine?--But then where did our queer ideas come from? Well, I shew you the possibility of a movement, say by means of a *picture* of the movement: 'so possibility is something which is like reality'. We say: "It isn't moving yet, but it already has the possibility of moving"--'so possibility is something very near reality'. Though we may doubt whether such-and-such physical

conditions make this movement possible, we never discuss whether *this* is the possibility of this or of that movement: 'so the possibility of the movement stands in a unique relation to the movement itself; closer than that of a picture to its subject'; for it can be doubted whether a picture is the picture of this thing or that. We say "Experience will shew whether this gives the pin this possibility of movement", but we do not say "Experience will shew whether this is the possibility of this movement": 'so it is not an empirical fact that this possibility is the possibility of precisely this movement'.

Page 87

We pay attention to the expressions we use concerning these things; we do not understand them, however, but misinterpret them. When we do philosophy we are like savages, primitive people, who hear the expressions of civilized men, put a false interpretation on them, and then draw queer conclusions from it.

Page 87

Imagine someone not understanding our past tense: "he has had it".--He says: "he *has*'--that's present, so the proposition says that in some sense the past is present."

Page 87

126. "But I don't mean that what I do now (in grasping a sense) determines the future use *causally* and as a matter of experience, but that in a *queer* way, the use itself is in some sense present." But of course it is, 'in *some* sense'! (And don't we also say: "the events of the years that are past are present to me"?) Really the only thing wrong with what you say is the expression "in a queer way". The rest is

Page Break 88

correct; and the sentence only seems queer when one imagines a different language-game for it from the one in which we actually use it. (Someone once told me that as a child he had wondered how a tailor '*sewed a dress*'--he thought this meant that a dress was produced *just by sewing*, by sewing one thread on to another.)

Page 88

127. In our failure to understand the use of a word we take it as the expression of a queer *process*. (As we think of time as a queer medium, of the mind as a queer kind of being.)

The difficulty arises in all these cases through mixing up "is" and "is called".

Page 88

128. The connexion which is not supposed to be a causal, experiential one, but much stricter and harder, so rigid even, that the one thing somehow already *is* the other, is always a connexion in grammar.

Page 88

129. How do I know that this picture is my image of the *sun*?--I *call* it an image of the sun. I *use* it as a picture of the *sun*.

Page 88

130. "It's as if we could grasp the whole use of the word in a flash."--And that is just what we say we do. That is to say: we sometimes describe what we do in these words. But there is nothing astonishing, nothing queer, about what happens. It becomes queer when we are led to think that the future development must in some way already be

Page Break 89

present in the act of grasping the use and yet isn't present.--For we say that there isn't any doubt that we understand the word..., and on the other hand its meaning lies in its use. There is no doubt that I now want to play *chess*, but chess is the game it is in virtue of *all its rules* (and so on). Don't I know, then, which game I wanted to play until I *have* played it? Or are all the rules contained in my act of intending? Is it experience that tells me that this sort of play usually follows this act of intention? So is it impossible for me to be certain what I am intending to do? And if that is nonsense, what kind of super-strong connexion exists between the act of intending and the thing intended?--Where is the connexion effected between the sense of the expression "Let's play a game of chess" and all the rules of the game?--Well, in the list of rules of the game, in the teaching of it, in the day-to-day practice of playing.

Page 89

131. The laws of logic are indeed the expression of 'thinking habits' but also of the habit of *thinking*. That is to say they can be said to shew: how human beings think, and also *what* human beings call "thinking".

Page 89

132. Frege calls it 'a law about what men take for true' that 'It is impossible for human beings... to recognize an object as different from itself'.†1--When I think of this as impossible for me, then I think of *trying* to do it. So I look at my lamp and say: "This lamp is different from itself". (But nothing stirs.) It is not that I see it is false, I can't do anything with it at all. (Except when the lamp shimmers in sunlight; then I can quite well use the sentence to

Page Break 90

express that.) One can even get oneself into a thinking-cramp, in which one *does* someone trying to think the impossible and not succeeding. Just as one can also *do* someone trying (vainly) to draw an object to himself from a distance by mere willing (in doing this one makes e.g. certain faces, as if one were trying, by one's expression, to give the thing to understand that it should come here.)

Page 90

133. The propositions of logic are 'laws of thought', 'because they bring out the essence of human thinking'--to put it more correctly: because they bring out, or shew, the essence, the technique, of thinking. They shew what thinking is and also shew kinds of thinking.

Page 90

134. Logic, it may be said, shews us what we understand by 'proposition' and by 'language'.

Page 90

135. Imagine the following queer possibility: we have always gone wrong up to now in multiplying 12×12 . True, it is unintelligible how this can have happened, but it has happened. So everything worked out in this way is wrong!--But what does it matter? It does not matter at all!--And in that case there must be something wrong in our idea of the truth and falsity of arithmetical propositions.

Page 90

136. But then, is it impossible for me to have gone wrong in my calculation? And what if a devil deceives me, so that I keep on overlooking something however often I go over the sum step by step? So that if I were to awake from the enchantment I should say: "Why, was I blind?"--But what difference does it make for me to 'assume'

Page Break 91

this? I might say: "Yes to be sure, the calculation is wrong--but that is how I calculate. And this is what I now call adding, and this 'the sum of these two numbers'."

Page 91

137. Imagine someone bewitched so that he calculated:

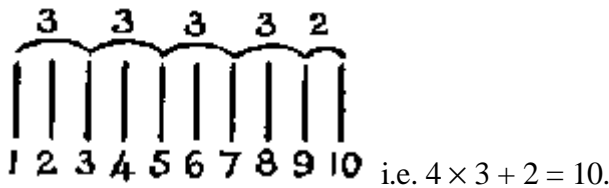

Now he is to apply this calculation. He takes 3 nuts four times over, and then 2 more, and he divides them among 10 people and each one gets *one* nut; for he shares them out in a way corresponding to the loops of the calculation, and as often as he gives someone a second nut it disappears.

Page 91

138. One might also say: in a proof you advance from one proposition to another; but do you also accept a check on whether you have gone right?--Or do you merely say "It *must* be right" and measure everything else by the proposition you arrive at?

Page 91

139. For if *that* is how it is, then you are only advancing from one picture to another.

Page 91

140. It might be practical to measure with a ruler which had the property of shrinking to, say, half its length when it was taken from this room to that. A property which would make it useless as a ruler in other circumstances.

Page Break 92

Page 92

It might be practical, in certain circumstances, to leave numbers out when you were counting a set: to count them: 1, 2, 4, 5, 7, 8, 10.

Page 92

141. What goes on when someone tries to make a shape coincide with its mirror-image by moving it about in the plane, and does not succeed? He puts them one on top of the other in various ways; looks at the parts that don't coincide; is dissatisfied; says perhaps: "But it *must* work", and puts the figures together again in another way.

What happens when someone tries to lift a weight and does not succeed because the weight is too heavy? He assumes such and such a posture, takes hold of the weight, tenses such and such muscles, and then lets go and perhaps shews dissatisfaction.

How does the geometrical, logical impossibility of the first task come out?

"Well, he could surely have shewn, in a picture or in some other way, what the thing he is attempting in the second case looks like." But he asserts that he can do that in the first case too by putting two similar *congruent* figures together so that they coincide.--What are we to say now? That the two examples are different? But so are the picture and the reality in the second case.

Page 92

142. What we are supplying are really remarks on the natural history of man: not curiosities however, but rather observations on facts which no one has doubted and which have only gone unremarked because they are always before our eyes.

Page 92

143. We teach someone a method of sharing out nuts among

Page Break 93

people; a part of this method is multiplying two numbers in the decimal system.

We teach someone to build a house; and at the same time how he is to obtain a sufficient quantity of material, boards, say; and for this purpose a technique of calculation. The technique of calculation is part of the technique of house-building.

People pile up logs and sell them, the piles are measured with a ruler, the measurements of length, breadth and height multiplied together, and what comes out is the number of pence which have to be asked and given. They do not know 'why' it happens like this; they simply do it like this: that is how it is done.--Do these people not calculate?

Page 93

144. If somebody calculates like this must he utter any 'arithmetical *proposition*'? Of course, we teach children the multiplication tables in the form of little *sentences*, but is that essential? Why shouldn't they simply: *learn to calculate*? And when they can do so haven't they learnt arithmetic?

Page 93

145. But in that case how is the *foundation* of a calculating procedure related to the calculation itself?

Page 93

146. "Yes, I understand that this proposition follows from that."--Do I understand *why* it follows or do I only understand *that* it follows?

Page 93

147. Suppose I had said: those people pay for wood on the *ground of calculation*; they accept a calculation as proof that they have to pay so much.--Well, that is simply a description of their procedure (of their behaviour).

Page Break 94

Page 94

148. Those people--we should say--sell timber by cubic measure--but are they right in doing so? Wouldn't it be more correct to sell it by weight--or by the time that it took to fell the timber--or by the labour of felling measured by the age and strength of the woodsman? And why should they not hand it over for a price which is independent of all this: each buyer pays the same however much he takes (they have found it possible to live like that). And is there anything to be said against simply giving the wood away?

Page 94

149. Very well; but what if they piled the timber in heaps of arbitrary, varying height and then sold it at a price proportionate to the area covered by the piles?

And what if they even justified this with the words: "Of course, if you buy more timber, you must pay more"?

Page 94

150. How could I shew them that--as I should say--you don't really buy more wood if you buy a pile covering a bigger area?--I should, for instance, take a pile which was small by their ideas and, by laying the logs around, change it into a 'big' one. This *might* convince them--but perhaps they would say: "Yes, now it's a *lot* of wood and costs more"--and that would be the end of the matter.--We should presumably say in this case: they simply do not mean the same by "a lot of wood" and "a little wood" as we do; and they have a quite different system of payment from us.

Page 94

151. (A society acting in this way would perhaps remind us of the Wise Men of Gotham.)

Page Break 95

152. Frege says in the preface to the *Grundgesetze der Arithmetik*†1: "... here we have a hitherto unknown kind of insanity"--but he never said what this 'insanity' would really be like.

153. What does people's agreement about accepting a structure as a proof consist in? In the fact that they use words as *language*? As what we call "language".

Imagine people who used money in transactions; that is to say coins, looking like our coins, which are made of gold and silver and stamped and are also handed over for goods--but each person gives just what he pleases for the goods, and the merchant does not give the customer more or less according to what he pays. In short this money, or what looks like money, has among them a quite different role from among us. We should feel much less akin to these people than to people who are not yet acquainted with money at all and practise a primitive kind of barter.--"But these people's coins will surely also have some purpose!"--Then has everything that one does a purpose? Say religious actions--.

It is perfectly possible that we should be inclined to call people who behaved like this insane. And yet we don't call everyone insane who acts similarly within the forms of our culture, who uses words 'without purpose'. (Think of the coronation of a King.)

154. Perspicuity is part of proof. If the process by means of which I get a result were not surveyable, I might indeed make a note that this number is what comes out--but what fact is this supposed to confirm for me? I don't know 'what is *supposed* to come out'.

155. Would it be possible that people should go through one of our calculations to-day and be satisfied with the conclusions, but to-morrow want to draw quite different conclusions, and other ones again on another day?

Why, isn't it imaginable that it should *regularly* happen like that: that when we make *this* transition one time, the next time, '*just for that reason*', we make a different one, and therefore (say) the next time the first one again? (As if in some language the colour which is called "red" one time is for that reason called another name the next time, and "red" again the next time after that and so on; people might find this natural. It might be called a need for variety.)

[*Note in margin: Are our laws of inference eternal and immutable?*]

156. Isn't it like this: so long as one thinks it can't be otherwise, one draws logical conclusions. This presumably means: so long as *such-and-such is not brought in question at all*.

The steps which are not brought in question are logical inferences. But the reason why they are not brought in question is not that they 'certainly correspond to the truth'--or something of the sort,--no, it is just this that is called 'thinking', 'speaking', 'inferring', 'arguing'. There is not any question at all here of some correspondence between what is said and reality; rather is logic *antecedent* to any such correspondence; in the same sense, that is, as that in which the establishment of a method of measurement is *antecedent* to the correctness or incorrectness of a statement of length.

157. Is it experimentally settled whether one proposition can be derived from another?--It looks as if it were. For I write down certain sequences of signs, am guided in doing so by certain paradigms--in doing which it is indeed essential that no sign should get overlooked

or otherwise lost--and of what I get in this procedure I say: it follows.--One argument against this is: If 2 and 2 apples add up to only 3 apples, i.e. if there are 3 apples there after I have put down two and again two, I don't say: "So after all 2 + 2 are not always 4"; but "Somehow one must have gone".

158. But how am I making an experiment when I merely *follow* a proof which has already been written out? It might be said: "When you look at this chain of transformations,--*don't they strike you as being in agreement with the paradigms?*".

159. So if this is to be called an experiment it is presumably a psychological one. For the appearance of agreement may of course be founded on sense-deception. And so it sometimes is when we make a slip in

calculating.

One also says: "This is my result". And what shews that this is *my* result is presumably an experiment.

Page 97

160. One might say: the result of the experiment is that at the end, having reached the result of the proof, I say with conviction: "Yes, that's right".

Page 97

161. Is a calculation an experiment?--Is it an experiment for me to get out of bed in the morning? But might it not be an experiment,--to shew whether I have the strength to raise myself up after so and so many hours' sleep?

And how does the action fall short of being this experiment?--Merely by not being carried out with this purpose, i.e. in connexion

Page Break 98

with an investigation of this kind. It is the use that is made of something that turns it into an experiment.

Is an experiment in which we observe the acceleration of a freely falling body a physical experiment, or is it a psychological one shewing what people see in such circumstances?--Can't it be either? Doesn't it depend on its *surroundings*: on what we do with it, say about it?

Page 98

162. If a proof is conceived as an experiment, at any rate the result of the experiment is not what is called the result of the proof. The result of the calculation is the proposition with which it concludes; the result of the experiment is that from these propositions, by means of these rules, I was led to this proposition.

Page 98

163. But our interest does not attach to the fact that such-and-such (or all) human beings have been led this way by these rules (or have gone this way); we take it as a matter of course that people--'if they can think correctly'--go *this* way. We have now been given a *road*, as it were by means of the footsteps of those who have gone this way. And the traffic now proceeds on this road--to various purposes.

Page 98

164. Certainly experience tells me how the calculation comes out; but that is not all there is to my accepting it.

Page 98

165. I learned empirically that this came out this time, that it usually does come out; but does the proposition of mathematics say

Page Break 99

that? I learned empirically that this is the road I travelled. But is *that* the mathematical statement?--What does it say, though? What relation has it to these empirical propositions? The mathematical proposition has the dignity of a rule.

So much is true when it's said that mathematics is logic: its moves are from rules of our language to other rules of our language. And this gives it its peculiar solidity, its unassailable position, set apart.

(Mathematics deposited among the standard measures.)

Page 99

166. What, then--does it just twist and turn about within these rules?--It forms ever new rules: is always building new roads for traffic; by extending the network of the old ones.

Page 99

167. But then doesn't it need a sanction for this? Can it extend the network *arbitrarily*? Well, I could say: a mathematician is always inventing new forms of description. Some, stimulated by practical needs, others, from aesthetic needs,--and yet others in a variety of ways. And here imagine a landscape gardener designing paths for the layout of a garden; it may well be that he draws them on a drawing-board merely as ornamental strips without the slightest thought of someone's sometime walking on them.

Page 99

168. The mathematician is an inventor, not a discoverer.

Page 99

169. We know by experience that when we count anything off on the fingers of one hand, or on some group of things that looks like this ||||, and say: I, you, I, you, etc., the first word is also the last.

Page Break 100

"But doesn't it *have* to be like that, then?"--Well, is it unimaginable for someone to see the group |||| (e.g.) as the group |||| with the two middle strokes fused, and should accordingly count the middle stroke twice? (True, it is not the usual case.--)

170. But how about when I draw someone's attention for the first time to the fact that the result of counting off is determined in advance by the beginning, and he understands and says: "Yes, of course,--that's how it has to be". What sort of knowledge is this?--He e.g. drew himself the schema:



and his reasoning is e.g.: "*That's* what it's like when I count off.--So it has to...."

(171. Connected with this: We should sometimes like to say "There must surely be a reason why--in a movement of a sonata, for example--just *this* theme follows that one." What we should acknowledge as a reason would be a certain relation between the themes, a kinship, a contrast or the like.--But we may even construct such a relation: an operation, so to speak, that produces the one theme from the other; but this serves only when this relation is one that we are familiar with. So it is as if the sequence of these themes had to correspond to a paradigm that is already present in us.

Similarly one might say of a picture that shews two human figures: "There must be a reason why precisely *these* two faces make such an impression upon us." That means: we should like to find this impression from the pair of faces again somewhere else--in another region.--But could we?

One might ask: what arrangement of themes together has a *point*, and what has *no* point? Or again: *Why* has this arrangement a point and *this* one none? That may not be easy to say! Often we may say: "This one corresponds to a gesture, this one doesn't.")†1

APPENDIX I (1933-1934)

1. Might I not say that two words--let's write them "non" and "ne"--had the same meaning, that they were both negation signs--but

$$\text{non non } p = p$$

and

$$\text{ne ne } p = \text{ne } p$$

(In spoken language a double negation very often means a negation.) But then why do I call them both "negations"? What have they in common with one another? Well, it is clear that a great part of their employment is common. But that does not solve our problem. For we should after all like to say: "It must also hold for both of them that the double negation is an affirmation, at least if the doubling is thought of appropriately". But *how?*--Well, as for example we expressed it using brackets:

$$(\text{ne ne})p = \text{ne } p, \text{ ne}(\text{ne } p) = p$$

We think at once of an analogous case in geometry: "Two half turns added together cancel one another out," "Two half turns added together make one half turn."

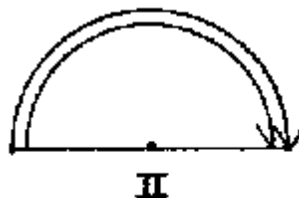
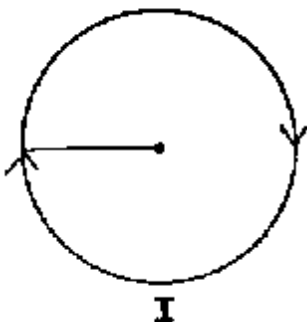

It just depends how we add them. (Whether we put them side by side or one after the other.)

2. (Here we stumble on a remarkable and characteristic phenomenon in philosophical investigation: The difficulty--I might say--isn't one

Page Break 103

of finding the solution; it is one of recognizing something as the solution. We have already said everything. Not something that follows from this; no, just *this* is the solution!

This, I believe, hangs together with our wrongly expecting an explanation; whereas a description is the solution of the difficulty, if we give it the right place in our consideration. If we dwell upon it and do not try to get beyond it.)

Page 103

3. "That's already all there is to say about it." *Taking* "non non p " as the negation of the negated proposition in the particular case is, say, giving an explanation of the kind "non non $p = \text{non}(\text{non } p)$ ".

Page 103

4. "If 'ne' is a negation, then 'ne ne p ' must be the same as p , if only it is taken appropriately."

"If one takes 'ne ne p ' as negating p , one must be taking the doubling in a different way."

One would like to say: "'Doubling' *means* something different in this case and *that's* why it yields a negation here;" and so, its yielding a negation here is the consequence of this difference of nature. "Now I mean it as a strengthening", one would say. *We* use the expression of meaning to assess meaning.†1

Page 103

5. When I was uttering the double negation, what may it have

Page Break 104

consisted in that I meant it as a strengthening? In the circumstances in which I use the expression, perhaps in the image that comes before my mind as I use it or which I employ, in my tone of voice (as I can even reproduce the brackets in "ne (ne p)" in my tone of voice). In that case, meaning the doubling as a strengthening corresponds to pronouncing it as a strengthening. The activity of meaning the doubling as a cancellation was e.g., putting brackets.--"Yes, but these brackets themselves may have a variety of roles; for who says that they are to be taken as brackets in the ordinary sense in 'non (non p)' and not for example the first as a hyphen between the two 'non's and the second as the full stop for the sentence? No one says it. And haven't you yourself replaced your conception by words? What the brackets mean will come out in their use; and in another sense perhaps lies in the rhythm of the optical impression of 'non (non p)'.

Page 104

6. Am I now to say: the meanings of "non" and "ne" are *somewhat* different? That they are different species of negation?--That no one would say. For it would be objected, in that case won't "do not go into this room" perhaps fail to mean exactly the same as usual if we set up the rule that "not not" is to be used as a negation?--But this might be countered: "If the two propositions 'ne p ' and 'non p ' say exactly the same, then how can 'ne ne' not mean exactly the same as 'non non'?" But here we are presupposing a symbolism--i.e., we are taking it as a model--in which from "ne $p = \text{non } p$ " it follows that "ne" and "non" are used in the same way in all cases.

Turning through 180° and negation are in fact the same in the particular case, and the application of 'non non $p = p$ ' is of the same kind as the application of a particular geometry.

Page Break 105

Page 105

7. What does one mean by saying: 'ne ne p ', even if by convention it means 'ne p ', *could* also be used as a cancelled negation?--One would like to say: "with the meaning that we have given it, 'ne' could cancel itself, if only we apply it right." What does one mean by that? (The two half turns in the same direction could cancel one another, if they are put together appropriately.) "The *movement* of the negation 'not' is capable of cancelling itself." But where is this movement? One would like of course to speak of a mental movement of negation, for the execution of which the sign 'ne' merely gives the signal.

Page 105

8. We can imagine human beings with a 'more primitive' logic, in which only for certain sentences is there anything corresponding to our negation: say for such as contain no negation. In the language of these people, then, a sentence like "He is going into this house" could be negated; but they would understand a doubling of the negation as mere repetition, never as cancelling the negation.

Page 105

9. The question whether negation had the same meaning for these people as for us would be analogous to the

question whether the digit '2' means the same, for people whose number series ends with 5, as it does for us.

Page 105

10. Suppose I were to ask: When we pronounce the proposition "this rod is 1 metre long" and 'here is 1 soldier', is it quite apparent to us that "1" has different meanings here?--It is not at all apparent. Especially when we say a sentence like: "On every 1 metre there stands 1 soldier, every 2 metres 2 soldiers, and so on." Asked, "Do you

Page Break 106

mean the same by the two ones?" we should reply: "of course I mean the same:--*one*" (perhaps holding up one finger).

Page 106

11. Whoever calls " $\sim\sim p = p$ " (or again " $\sim\sim p \equiv p$ ") a "necessary proposition of logic" (not a stipulation about the method of presentation that we adopt) also has a tendency to say that this proposition proceeds from the meaning of negation. When double negation is used as negation in some dialect, as in "he found nothing nowhere", we are inclined to say: *really* that would mean that he found something everywhere. Let us consider what this "really" means.

Page 106

12. Suppose we had two systems for measuring length; in both a length is expressed by a numeral, followed by a word that gives the system of measurement. One system designates a length as " n foot" and foot is a unit of length in the ordinary sense; in the other system a length is designated by " n W" and

$$1 \text{ foot} = 1 \text{ W}$$

But: $2 \text{ W} = 4 \text{ foot}$, $3 \text{ W} = 9 \text{ foot}$ and so on.

So the sentence "this post is 1 W long" says the same as "this post is 1 foot long".

Question: Have "W" and "foot" the same meaning in these two sentences?

Page 106

13. The question is framed wrong. One sees this when we express identity of meaning by means of an equation. Then the question has to run: "Does $\text{W} = \text{foot}$ or not?"--The sentences in which these signs occur disappear in this way of looking at it. Of course in this terminology one can just as little ask whether "is" means the same as "is";

Page Break 107

but one *can* ask whether " ϵ " means the same as " $=$ ". What we *said* was: $1 \text{ foot} = 1 \text{ W}$, but: $\text{foot} \neq \text{W}$.

Page 107

14. Has "ne" the same meaning as "non"?--Can I replace "non" by "ne"?--"Well, I can in certain places, but not in others."--But I wasn't asking about that. My question was: can one, without any further qualification, use "ne" in place of "non"?--No.

Page 107

15. "'ne' and 'non' mean exactly the same in this case."--And *what* do they mean?--"Well, one is *not* to do such and such."--But by saying this you have only said that in this case $\text{ne } p = \text{non } p$ and that we don't deny.

When you explain: $\text{ne } p = \text{ne } p$, $\text{non } p = p$, you are indeed using the two words in different ways; and if one holds on to the conception that what they yield in certain combinations 'depends' on their meaning, or the meaning that they carry around with them, then one has to say that they must have different meanings if, compounded in the same way, they may yet yield different results.

Page 107

16. One would like to speak of the *function* of the word, of what it does, in this sentence. As of the function of a lever in a machine. But what does this function consist in? How does it come to light? For there isn't anything hidden, is there? We see the whole sentence all right. The function must reveal itself in the course of the calculus.

But one wants to say: "'non' *does* the same with the proposition ' p ' as 'ne' does: it reverses it". But that is just " $\text{non } p = \text{ne } p$ " in other words.†1 Over and over the thought, the picture, that what we

Page Break 108

see of the sign is only the exterior of some inner thing in which the real operations of meaning run on.

Page 108

17. But if the use of a sign is its meaning is it not remarkable that I say the word "is" gets used with two different meanings (as 'ε' and '=') and should not like to say that its meaning is its use as copula and as sign of identity?

One would like to say that these two kinds of use do not yield a *single* meaning; the personal union through the same word is inessential, is mere accident.

Page 108

18. But how can I decide what is an essential and what is an inessential, accidental feature of the notation? Is there a reality behind the notation, then, which its grammar is aiming at?

Think of a similar case in a game: In draughts a king is distinguished by putting two pieces one on top of the other. Won't one say that it is inessential to draughts that this is the way a king is distinguished?

Page 108

19. Let us say: the meaning of a piece (a figure) is its role in the game.--Now before the start of any chess-game let it be decided by lot which of the players gets white. For this purpose one player holds a king in each closed hand and the other chooses one of the hands at random. Will it be reckoned as part of the role of the king in chess that it is used for drawing by lot?

Page Break 109

Page 109

20. Thus even in a game I am inclined to distinguish between essential and inessential. The game, I should like to say, does not just have rules; it has a point.

Page 109

21. What is the word the same for? For in the calculus we make no use of this identity! What do both players have the same pieces for? But what does "making use of the identity" mean here? For isn't it a use, if we do use the same word?

Page 109

22. Here it looks now as if the use of the same word, the same piece, had a *purpose*--if the identity was not accidental, not inessential. And as if the purpose were that one should recognize the piece and be able to tell how to play. Is it a physical or a logical possibility that is in question here? If the latter, then the identity of the pieces does indeed belong to the game.

Page 109

23. The game is supposed to be defined by the rules! So if a rule of the game prescribes that the kings are to be taken for choosing by lot before the game starts then that belongs essentially to the game. What objection might be made to this?--That one does not see the point of this rule. As, say, one wouldn't see the point of a prescription either, that required one to turn any piece round three times before making a move with it. If we found this rule in a board-game, we should be surprised, and form conjectures about the origin, the purpose, of such a rule. ("Is this prescription supposed to prevent one from moving without consideration?")

Page Break 110

Page 110

24. "If I understand the character of the game right," I might say, "this is not essential to it."

Page 110

25. But let us think of the two offices joined in one person as an old convention.

Page 110

26. One says: the use of the same word is inessential *here*, because the identity of the shape of the word does not here serve to mediate a transition. But in saying that one is merely describing the character of the game that one wants to play.

Page 110

27. †1 "What does the word 'a' mean in the sentence 'F(a)'?" "What does the word 'a' mean in the sentence 'Fa' which you have just spoken?" "What does the word mean in this sentence?"

Page Break 111

APPENDIX II

Page 111

1. The surprising may play two completely different parts in mathematics.

One may see the value of a mathematical train of thought in its bringing to light something that surprises us:--because it is of great interest, of great importance, to see how such and such a kind of representation of it makes a situation surprising, or astonishing, even paradoxical.

But different from this is a conception, dominant at the present day, which values the surprising, the astonishing, because it shews the depths to which mathematical investigation penetrates;--as we might measure the

value of a telescope by its shewing us things that we'd have had no *inkling* of without this instrument. The mathematician says as it were: "Do you see, this is surely important, this you would never have known without me." As if, by means of these considerations, as by means of a kind of higher experiment, astonishing, nay *the most* astonishing facts were brought to light.

Page 111

2. But the mathematician is not a discoverer: he is an inventor.

"The demonstration has a surprising result!"--If you are surprised, then you have not understood it yet. For surprise is not legitimate here, as it is with the issue of an experiment. *There*--I should like to say--it is permissible to yield to its charm; but not when the surprise comes to you at the end of a chain of inference. For here it is only a sign that unclarity or some misunderstanding still reigns.

"But why should I not be surprised that I have been led *hither*?"--Imagine you had a long algebraic expression before you; at first it looks as if it could not be essentially shortened; but then you see a possibility of shortening it and now it goes on until the expression

Page Break 112

is shrunk into a compact form. May we not be surprised at this result? (Something similar happens in playing Patience.) Certainly, and it is a pleasant surprise; and it is of psychological interest, for it shows a phenomenon of failure to command a clear view and of the change of aspect of a seen complex. It is interesting that one does not always see in this complex that it can be shortened in this way; but if we are able to survey the way of shortening it, the surprise disappears.

When one says that one just is surprised at having been led *to this*, that does not represent the situation quite correctly. For one surely has this surprise only when one does not yet know the way. Not when one has the whole of it before one's eyes. The fact that this way, that I have completely in view, begins where it begins and ends where it ends, that's no surprise. The surprise and the interest, then come, so to speak, from outside. I mean: one can say "This mathematical investigation is of great psychological interest" or "of great physical interest."

Page 112

3. I keep on being astonished at this turn of the theme; though I have heard it countless times and know it by heart. It is perhaps its *sense* to arouse astonishment.

What is it supposed to mean, then, when I say "You *oughtn't* be astonished?"

Think of mathematical puzzles. They are framed because they surprise: that is their whole sense.

I want to say: You ought not to believe that there is something hidden here, into which one can get no insight--as if we had walked through an underground passage and now come up somewhere into the light, without being able to tell how we got here, or how the entry of the tunnel lay in relation to its exit.

But then how was it possible for us to fancy this at all? What is there about a calculation that is like a movement underground? What can have suggested this picture to us? I believe it is this: no daylight

Page Break 113

falls on these steps; that we understand the starting point and the end of the calculation in a sense in which we do not understand the remaining course of the calculation.

Page 113

4. "There's no mystery here!"--but then how can we have so much as believed that there was one?--Well, I have retraced the path over and over again and over and over again been surprised; and I never had the idea that here one can *understand* something.--So "There's no mystery here!" means "Just look about you!"

Page 113

5. Isn't it as if one saw a sort of turning up of a card in a calculation? One mixed up the cards; one doesn't know what was going on among them; but in the end this card came out on top, and this means that rain is coming.

Page 113

6. The difference between casting lots and counting out before a game. But might not naive people even when it is a serious matter use counting out instead of choosing a man by lot?

Page 113

7. What is someone doing when he makes us realize that in counting out the result is already fixed?

Page 113

8. I want to say: "We don't command a clear view of what we have done, and that is why it strikes us as mysterious. For now there is a result in front of us and we no longer know how we got there,

Page Break 114

it is not perspicuous to us, but we say (we have learnt to say): "this is how it has to be"; and we accept it--and marvel

at it. Might we not imagine the following case: Someone has a series of orders of the form "You must now do such and such", each one written on a card. He mixes these cards up together, reads the one that comes out on top and says: so I *must* do *that*?--For the reading of a written order now makes a particular impression, has a particular effect on him. And so equally has the reaching of the conclusion of an inference.--However, one might perhaps break the spell of such an order, by bringing it clearly before the man's eyes again *how* he arrived at these words, and comparing what happened here with other cases--by saying, e.g.: "After all, no one has given you the order!"

And isn't it like *that*, when I say "There's no mystery here"?--Indeed, in a certain sense he had not believed that there was a mystery in the case. But he was under the *impression* of mystery (as the other was under the *impression* of an order). In *one* sense he was indeed acquainted with the situation, but he related to it (in feeling and in action) 'as if there were something else involved'--as we would say.

Page 114

9. "A definition surely only takes you one step further back, to something that is not defined." What does that tell us? Did anyone not know that?--No--but may he not have lost sight of it?

Page 114

10. Or: "If you write

'1, 4, 9, 16...',

you have merely written down four numbers and four dots"--what are you bringing to our notice here? Could anyone think anything else? It would also be natural to say: "You have written nothing there except four numerals and a fifth sign--the dots." Well didn't he know

Page Break 115

this? Still, he might say, mightn't he, "I never really looked on the dots as *one* further sign in this series of signs--but rather as a way of suggesting further numerals."

Page 115

11. Or suppose someone gets us to notice that a line, in Euclid's sense, is a boundary of two coloured surfaces, and not a mark? and a point the intersection of such colour boundaries and not a dot? (How often has it been said that you cannot imagine a point.)

Page 115

12. It is possible for one to live, to think, in the fancy that things are thus and so, without *believing* it; that is to say, when one is asked, then one knows, but if one does not have to answer the question one does *not* know, but acts and thinks according to another opinion.

Page 115

13. For a form of expression makes us act thus and so. When it dominates our thinking, then in spite of all objections we should like to say: "But surely it *is* so in some sense." Although the 'some sense' is just what matters. (Roughly like the way it signifies a man's dishonesty when we say "He's *not* a *thief*".)

Page Break 116

APPENDIX III

Page 116

1. It is easy to think of a language in which there is not a form for questions, or commands, but question and command are expressed in the form of statements, e.g. in forms corresponding to our: "I should like to know if..." and "My wish is that..."

No one would say of a question (e.g. whether it is raining outside) that it was true or false. Of course it is English to say so of such a sentence as "I want to know whether...". But suppose this form were always used instead of the question?--

Page 116

2. The great majority of sentences that we speak, write and read, are statement sentences.

And--you say--these sentences are true or false. Or, as I might also say, the game of truth-functions is played with them. For assertion is not something that gets added to the proposition, but an essential feature of the game we play with it. Comparable, say, to that characteristic of chess by which there is winning and losing in it, the winner being the one who takes the other's king. Of course, there could be a game in a certain sense very near akin to chess, consisting in making the chess moves, but without there being any winning and losing in it; or with different conditions for winning.

Page 116

3. Imagine it were said: A command consists of a proposal ('assumption') and the commanding of the thing proposed.

4. Might we not do arithmetic without having the idea of uttering arithmetical *propositions*, and without ever having been struck by the similarity between a multiplication and a proposition?

Should we not shake our heads, though, when someone shewed us a multiplication done wrong, as we do when someone tells us it is raining, if it is not raining?--Yes; and here is a point of connexion. But we also make gestures to stop our dog, e.g. when he behaves as we do not wish.

We are used to saying "2 times 2 is 4", and the verb "is" makes this into a proposition, and apparently establishes a close kinship with everything that we call a 'proposition'. Whereas it is a matter only of a very superficial relationship.

5. Are there true propositions in Russell's system, which cannot be proved in his system?--What is called a true proposition in Russell's system, then?

6. For what does a proposition's '*being true*' mean? '*p is true = p*'. (That is the answer.)

So we want to ask something like: under what circumstances do we assert a proposition? Or: how is the assertion of the proposition used in the language-game? And the 'assertion of the proposition' is here contrasted with the utterance of the sentence e.g. as practice in elocution,--or as *part* of another proposition, and so on.

If, then, we ask in this sense: "Under what circumstances is a proposition asserted in Russell's game?" the answer is: at the end of one of his proofs, or as a 'fundamental law' (Pp.). There is no other way in this system of employing asserted propositions in Russell's symbolism.

7. "But may there not be true propositions which are written in this symbolism, but are not provable in Russell's system?"--'True propositions', hence propositions which are true in *another* system, i.e. can rightly be asserted in another game. Certainly; why should there not be such propositions; or rather: why should not propositions--of physics, e.g.--be written in Russell's symbolism? The question is quite analogous to: Can there be true propositions in the language of Euclid, which are not provable in his system, but are true?--Why, there are even propositions which are provable in Euclid's system, but are *false* in another system. May not triangles be--in another system--similar (*very* similar) which do not have equal angles?--"But that's just a joke! For in that case they are not 'similar' to one another in the same sense!"--Of course not; and a proposition which cannot be proved in Russell's system is "true" or "false" in a different sense from a proposition of *Principia Mathematica*.

8. I imagine someone asking my advice; he says: "I have constructed a proposition (I will use '*P*' to designate it) in Russell's symbolism, and by means of certain definitions and transformations it can be so interpreted that it says: '*P* is not provable in Russell's system'. Must I not say that this proposition on the one hand is true, and on the other hand is unprovable? For suppose it were false; then it is true that it is provable. And that surely cannot be! And if it is proved, then it is proved that it is not provable. Thus it can only be true, but unprovable."

Just as we ask: "'provable' in what system?", so we must also ask: "'true' in what system?" 'True in Russell's system' means, as was said: proved in Russell's system; and 'false in Russell's system' means: the opposite has been proved in Russell's system.--Now what does your "suppose it is false" mean? *In the Russell sense* it means 'suppose the opposite is proved in Russell's system'; *if that is your assumption*, you will now presumably give up the interpretation that it is

unprovable. And by 'this interpretation' I understand the translation into this English sentence.--If you assume that the proposition is provable in Russell's system, that means it is true *in the Russell sense*, and the interpretation "*P* is not provable" again has to be given up. If you assume that the proposition is true in the Russell sense, *the same* thing follows. Further: if the proposition is supposed to be false in some other than the Russell sense, then it does not contradict this for it to be proved in Russell's system. (What is called "losing" in chess may constitute winning in another game.)

9. For what does it mean to say that *P* and "*P* is unprovable" are the same proposition? It means that these *two* English sentences have a *single* expression in such-and-such a notation.

10. "But surely P cannot be provable, for, supposing it were proved, then the proposition that it is not provable would be proved." But if this were now proved, or if I believed--perhaps through an error--that I had proved it, why should I not let the proof stand and say I must withdraw my interpretation "*unprovable*"?

Page 119

11. Let us suppose I prove the unprovability (in Russell's system) of P ; then by this proof I have proved P . Now if this proof were one in Russell's system--I should in that case have proved at once that it belonged and did not belong to Russell's system.--That is what comes of making up such sentences.--But there is a contradiction here!--Well, then there is a contradiction here. Does it do any harm here?

Page Break 120

Page 120

12. Is there harm in the contradiction that arises when someone says: "I am lying.--So I am not lying.--So I am lying.--etc."? I mean: does it make our language less usable if in this case, according to the ordinary rules, a proposition yields its contradictory, and vice versa?--the proposition *itself* is unusable, and these inferences equally; but why should they not be made?--It is a profitless performance!--It is a language-game with some similarity to the game of thumb-catching.

Page 120

13. Such a contradiction is of interest only because it has tormented people, and because this shews both how tormenting problems can grow out of language, and what kind of things can torment us.

Page 120

14. A proof of unprovability is as it were a geometrical proof; a proof concerning the geometry of proofs. Quite analogous e.g. to a proof that such-and-such a construction is impossible with ruler and compass. Now such a proof contains an element of prediction, a physical element. For in consequence of such a proof we say to a man: "Don't exert yourself to find a construction (of the trisection of an angle, say)--it can be proved that it can't be done". That is to say: it is essential that the proof of unprovability should be capable of being applied in this way. It must--we might say--be a *forcible reason* for giving up the search for a proof (i.e. for a construction of such-and-such a kind).

A contradiction is unusable as such a prediction.

Page 120

15. Whether something is rightly called the proposition " X is unprovable" depends on how we prove this proposition. The proof

Page Break 121

alone shews what counts as the criterion of unprovability. The proof is part of the system of operations, of the game, in which the proposition is used, and shews us its 'sense'.

Thus the question is whether the 'proof of the unprovability of P ' is here a forcible reason for the assumption that a proof of P will not be found.

Page 121

16. The proposition " P is unprovable" has a different sense afterwards--from before it was proved.

If it is proved, then it is the terminal pattern in the proof of unprovability.--If it is unproved, then *what* is to count as a criterion of its truth is not yet *clear*, and--we can say--its sense is still veiled.

Page 121

17. Now how am I to take P as having been proved? By a proof of unprovability? Or in some other way? Suppose it is by a proof of unprovability. Now, in order to see *what* has been proved, look at the proof. Perhaps it has here been proved that such-and-such forms of proof do not lead to P .--Or, suppose P has been proved in a direct way--as I should like to put it--and so in that case there follows the proposition " P is unprovable", and it must now come out how this interpretation of the symbols of P collides with the fact of the proof, and why it has to be given up here.

Suppose however that not- P is proved.--Proved *how*? Say by P 's being proved directly--for from that follows that it is provable, and hence not- P . What am I to say now, " P " or "not- P "? Why not both? If someone asks me "Which is the case, P , or not- P ?" then I reply: P stands at the end of a Russellian proof, so you write P in the Russellian system; on the other hand, however, it is then provable and this is expressed by not- P , but this proposition does not stand at the end of a Russellian proof, and so does not belong to the Russellian system.

Page Break 122

--When the interpretation " P is unprovable" was given to P , this proof of P was not known, and so one cannot say that P says: *this* proof did not exist.--Once the proof has been constructed, this has created a *new situation*: and

now we have to decide whether we will call *this* a proof (a *further* proof), or whether we will still call *this* the statement of unprovability.

Suppose not- P is directly proved; it is therefore proved that P can be directly proved! So this is once more a question of interpretation--unless we now also have a direct proof of P . If it were like that, well, that is how it would be.

(The superstitious dread and veneration by mathematicians in face of contradiction.)

Page 122

18. "But suppose, now, that the proposition were *false*--and hence provable?"--Why do you call it 'false'? Because you can see a proof?--Or for other reasons? For in that case it doesn't matter. For one can quite well call the Law of Contradiction false, on the grounds that we very often make good sense by answering a question "Yes and no". And the same for the proposition ' $\sim\sim p = p$ ' because we employ double negation as a *strengthening* of the negation and not merely as its cancellation.

Page 122

19. You say: "..., so P is true and unprovable". That presumably means: "Therefore P ". That is all right with me--but for what purpose do you write down this 'assertion'? (It is as if someone had extracted from certain principles about natural forms and architectural style the idea that on Mount Everest, where no one can live, there belonged a ch  let in the Baroque style. And how could you make the truth of the assertion plausible to me, since you can make no use of it except to do these bits of legerdemain?)

Page Break 123

Page 123

20. Here one needs to remember that the propositions of logic are so constructed as to have *no* application as *information* in practice. So it could very well be said that they were not *propositions* at all; and one's writing them down at all stands in need of justification. Now if we append to these 'propositions' a further sentence-like structure of another kind, then we are all the more in the dark about what kind of application this system of sign-combinations is supposed to have; for the mere *ring of a sentence* is not enough to give these connexions of signs any meaning.

Page Break 124

Page Break 125

PART II

1938

Page 125

1. How far does the diagonal method prove that there is a number which--let's say--is not a square root? It is of course extremely easy to shew that there are numbers that aren't square roots--but how does *this* method shew it?

$\sqrt{1}$				
$\sqrt{2}$				
$\sqrt{3}$				
$\sqrt{4}$				

Have we a general concept of what it means to shew that there is a number that is not included in this infinite set?

Let us suppose that someone had been given the task of naming a number different from every \sqrt{n} ; but that he knew nothing of the diagonal procedure and had named the number $\sqrt[3]{2}$; and had shewn that it was not a value of \sqrt{n} . Or that he had said: assume that $\sqrt{2} = 1.4142\dots$ and subtract 1 from the first decimal, but have the rest of the places agree with $\sqrt{2}$. 1.3142 cannot be a value of \sqrt{n} .

Page 125

2. "Name a number that agrees with $\sqrt{2}$ at every second decimal place." What does this task demand? The question is: is it performed by the answer: It is the number got by the rule: develop $\sqrt{2}$ and add 1 or -1 to every second decimal place?

It is the same as the way the task: *Divide an angle into three* can be

Page Break 126

regarded as carried out by laying 3 equal angles together.

Page 126

3. If someone says: "Shew me a number different from all these", and is given the rule of the diagonal for answer, why should he not say: "But I didn't mean it like that!?" What you have given me is a rule for the step-by-step construction of numbers that are successively different from each of these.

"But why aren't you willing to call this too a method of calculating a number?"--But what is the method of calculating, and what the result, here? You will say that they are *one*, for it makes sense now to say: the number *D* is bigger than... and smaller than...; it can be squared etc. etc.

Is the question not really: What can this number be *used* for? True, that sounds queer.--But what it means is: what are its mathematical surroundings?

Page 126

4. So I am comparing methods of calculating--only here there are certainly very different ways of making comparisons. However, I am supposed in some sense to be comparing the *results* of the methods with one another. But this is enough to make everything unclear, for in one sense they don't each have a single result, or it is not clear in advance what is to be regarded here as *the* result in each case. I want to say that here we are afforded every opportunity of twisting and turning the meanings.

Page 126

5. Let us say--not: "This method gives a result", but rather: "it gives an infinite series of results". How do I compare infinite series of results? Well, there are very different things that I may call doing that.

Page Break 127

Page 127

6. The motto here is always: Take a *wider* look round.

Page 127

7. The result of a calculation expressed verbally is to be regarded with suspicion. The *calculation* illumines the meaning of the expression in words. It is the *finer* instrument for determining the meaning. If you want to know what the verbal expression means, look at the calculation; not the other way about. The verbal expression casts only a dim general glow over the calculation: but the calculation a brilliant light on the verbal expression. (As if you wanted to compare the heights of two mountains, not by the technique of measurement of heights, but by their apparent relation when looked at from below.)

Page 127

8. "I want to shew you a method by which you can serially *avoid* all these developments." The diagonal procedure is such a method.--"So it produces a series that is different--from all of these." Is that right?--Yes; if, that is, you want to apply these words to the described case.

Page 127

9. How would it be with the following method of construction? The diagonal number is produced by addition or subtraction of 1, but whether to add or subtract is only found out by continuing the original series to several places. Suppose it were now said: the development of the diagonal series never catches up with the development of the other series:--certainly the diagonal series avoids each of those series when it encounters it, but that is no help to it, as the development of the other series is again ahead of it. Here I can surely say: There is always one of the series for which it is not determined whether or not it is different from the diagonal series. It may be said: they run after one another to infinity, but the original series is always ahead.

Page Break 128

Page 128

"But your rule already reaches to infinity, so you already know quite precisely that the diagonal series will be different from any other!"--

Page 128

10. It means nothing to say: "*Therefore* the X numbers are not denumerable". One might say something like this: I call number-concept X non-denumerable if it has been stipulated that, whatever numbers falling under this concept you arrange in a series, the diagonal number of this series is also to fall under that concept.

11. Since my drawing is after all only the *indication* of infinity, why must it be like this

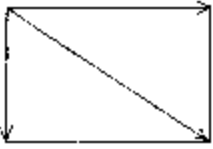

and not like this

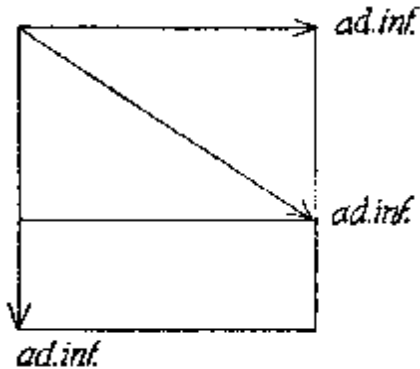

Here what we have is different pictures; and to them correspond different ways of talking. But does anything useful emerge if we have a dispute about the justification of *them*? What is important must reside

Page Break 129

somewhere else; even though these pictures fire our imagination most strongly.

Page 129

12. What can the concept 'non-denumerable' be used for?

Page 129

13. Surely--if anyone tried day-in day-out 'to put all irrational numbers into a series' we could say: "Leave it alone; it means nothing; don't you see, if you established a series, I should come along with the diagonal series!" This might get him to abandon his undertaking. Well, that would be useful. And it strikes me as if this were the whole and proper purpose of this method. It makes use of the vague notion of this man who goes on, as it were idiotically, with his work, and it brings him to a stop by means of a picture. (But one could get him to resume his undertaking by means of another picture.)

Page 129

14. The procedure exhibits something--which can in a very vague way be called the demonstration that *these* methods of calculation cannot be ordered in a series. And here the meaning of "*these*" is just kept vague.

Page 129

15. A clever man got caught in this net of language! So it must be an interesting net.

Page 129

16. The mistake begins when one says that the cardinal numbers can be ordered in a series. For what concept has one of this ordering? One has of course a concept of an infinite series, but here that gives

Page Break 130

us at most a vague idea, a guiding light for the formation of a concept. For the concept itself is *abstracted* from this and from other series; or: the expression stands for a certain analogy between cases, and it can e.g. be used to define provisionally a domain that one wants to talk about.

That, however, is not to say that the question: "Can the set R be ordered in a series?" has a clear sense. For this question means e.g.: Can one do something with these formations, corresponding to the ordering of the cardinal numbers in a series? Asked: "Can the real numbers be ordered in a series?" the conscientious answer might be: "For the time being I can't form any precise idea of that" -- "But you can order the roots and the algebraic numbers for example in a series; so you surely understand the expression!" -- To put it better, I *have got* certain analogous formations, which I call by the common name 'series'. But so far I haven't any certain bridge from these cases to that of 'all real numbers'. Nor have I any general method of trying whether such-and-such a set 'can be ordered in a series'.

Now I am shewn the diagonal procedure and told: "Now here you have the proof that this ordering can't be done here". But I can reply: "I don't know--to repeat--what it is that *can't be done* here". Though I can see that you want to shew a difference between the use of "root", "algebraic number", etc. on the one hand, and "real number" on

the other. Such a difference as e.g. this: roots are called "real numbers", *and so too* is the diagonal number formed from the roots. And similarly for all series of real numbers. For this reason it makes no sense to talk about a "series of all real numbers", just because the diagonal number for each series is also called a "real number".--Would this not be as if any row of books were itself ordinarily called a book, and now we said: "It makes no sense to speak of 'the row of all books', since this row would itself be a book."

Page Break 131

Page 131

17. Here it is very useful to imagine the diagonal procedure for the production of a real number as having been well-known before the invention of set theory, and familiar even to school-children, as indeed might very well have been the case. For this changes the aspect of Cantor's discovery. The discovery might very well have consisted *merely* in the interpretation of this long familiar elementary calculation.

Page 131

18. For this kind of calculation is itself useful. The question set would be perhaps: write down a decimal number which is different from the numbers:

0.1246798...

0.3469876...

0.0127649...

0.3426794...

..... (Imagine a long series.)

The child thinks to itself: how am I to do this, when I should have to look at all the numbers at once, to prevent what I write down from being one of them? Now the method says: Not at all: change the first place of the first number, the second of the second one etc. etc., and you are sure of having written down a number that does not coincide with any of the given ones. The number got in this way might always be called the diagonal number.

Page 131

19. The dangerous, deceptive thing about the idea: "The real numbers cannot be arranged in a series", or again "The set... is not denumerable" is that it makes the determination of a concept--concept formation--look like a fact of nature.

Page 131

20. The following sentence sounds sober: "If something is called a series of real numbers, then the expansion given by the diagonal

Page Break 132

procedure is also called a 'real number', and is moreover said to be different from all members of the series".

Page 132

21. Our suspicion ought always to be aroused when a proof proves more than its means allow it. Something of this sort might be called 'a puffed-up proof'.

Page 132

22. The usual expression creates the fiction of a procedure, a method of ordering which, though applicable here, nevertheless fails to reach its goal because of the number of objects involved, which is greater even than the number of all cardinal numbers.

If it were said: "Consideration of the diagonal procedure shews you that the *concept* 'real number' has much less analogy with the concept 'cardinal number' than we, being misled by certain analogies, are inclined to believe", that would have a good and honest sense. But just the *opposite* happens: one pretends to compare the 'set' of real numbers in magnitude with that of cardinal numbers. The difference in kind between the two conceptions is represented, by a skew form of expression, as difference of extension. I believe, and hope, that a future generation will laugh at this hocus pocus.

Page 132

23. The sickness of a time is cured by an alteration in the mode of life of human beings, and it was possible for the sickness of philosophical problems to get cured only through a changed mode of thought and of life, not through a medicine invented by an individual.

Think of the use of the motor-car producing or encouraging certain sicknesses, and mankind being plagued by such sickness until, from some cause or other, as the result of some development or other, it abandons the habit of driving.

Page Break 133

Page 133

24. For how do we make use of the proposition: "There is no greatest cardinal number"? When and on what occasion would it be said? This use is at any rate quite different from that of the mathematical proposition ' $25 \times 25 = 625$ '.

Page 133

25. First and foremost, notice that we ask this question at all; this points to the fact that the answer is not ready to hand.

Moreover, if one tries to answer the question in a hurry, it is easy to trip up. The case is like that of the question: what experience shews us that our space is three-dimensional?

Page 133

26. We say of a *permission* that it has no end.

Page 133

27. And it can be said that the permission to play language-games with cardinal numbers has no end. This would be said e.g. to someone to whom we were teaching our language and language-games. So it would again be a grammatical proposition, but of an *entirely* different kind from ' $25 \times 25 = 625$ '. It would however be of great importance if the pupil were, say, inclined to expect a definitive end to this series of language-games (perhaps because he had been brought up in a different culture).

Page 133

28. Why should we say: The irrational numbers cannot be ordered?--We have a method by which to upset any order.

Page 133

29. Cantor's diagonal procedure does not shew us an irrational

Page Break 134

number different from all in the system, but it gives sense to the mathematical proposition that the number so-and-so is different from all those of the system. Cantor could say: You can prove that a number is different from all the numbers in the system *by* proving that it differs in its first place from its first number and in its second place from its second number and so on.

Cantor is saying something about the multiplicity of the concept "Real number different from all the ones of a system".

Page 134

30. Cantor shews that if we have a system of expansions it makes sense to speak of an expansion that is different from them all.--But that is not enough to determine the grammar of the word "expansion".

Page 134

31. Cantor gives a sense to the expression "expansion which is different from all the expansions in a system", by proposing that an expansion should be so called when it can be proved that it is diagonally different from the expansions in a system.

Page 134

32. Thus it can be *set* as a question: Find a number whose expansion is diagonally different from those in this system.

Page 134

33. It might be said: Besides the rational points there are *diverse systems* of irrational points to be found in the number line.

There is no system of irrational numbers--but also no super-system, no 'set of irrational numbers' of higher-order infinity.

Page Break 135

Page 135

34. Cantor defines a *difference of higher order*, that is to say a difference of an expansion from a *system* of expansions. This definition can be used so as to shew that a number is in this sense different from a system of numbers: let us say π from the system of algebraic numbers. But we cannot very well say that the rule of altering the places in the diagonal in such-and-such a way is as such proved different from the rules of the system, because this rule is itself of 'higher order'; for it *treats of* the alteration of a system of rules, and for that reason it is not clear in advance in which cases we shall be willing to declare the expansion of *such a* rule different from all the expansions of the system.

Page 135

35. These considerations may lead us to say that $2^{\aleph_0} > \aleph_{0.1}$

That is to say: we can *make* the considerations lead us to that.

Or: we can say *this* and give *this* as our reason.

But if we do say it--what are we to do next? In what practice is this proposition anchored? It is for the time being a piece of mathematical architecture which hangs in the air, and looks as if it were, let us say, an architrave, but not supported by anything and supporting nothing.

Page 135

36. Certain considerations may lead us to say that 10^{10} souls fit into a cubic centimetre. But why do we nevertheless not say it? Because it is of no use. Because, while it does conjure up a picture, the picture is one with which we cannot go on to do anything.

Page 135

37. The proposition is worth as much as its grounds are.

It supports as much as the grounds that support it do.

Page 135

Page Break 136

Page 136

38. An interesting question is: what is the connexion of \hat{A}_0 with the cardinal numbers whose number it is supposed to be? \hat{A}_0 would obviously be the *predicate "infinite series"* in its application to the series of cardinal numbers and to similar mathematical formations. Here it is important to grasp the relationship between a series in the nonmathematical sense and one in the mathematical sense. It is of course clear that in mathematics we do *not* use the word "series of numbers" in the sense "series of numerical signs", even though, of course, there is also a connexion between the use of the one expression and of the other. A railway is not a railway train; nor is it something similar to a railway train. A 'series' in the mathematical sense is a method of construction for series of linguistic expressions.

Thus we have a grammatical class "infinite sequence", and equivalent with this expression a word whose grammar has (a certain) similarity with that of a numeral: "infinity" or " \hat{A}_0 ". This is connected with the fact that among the calculi of mathematics we have a technique which there is a certain justice in calling "1-1 correlation of the members of two infinite series", since it has a similarity to such a mutual correlation of the members of what are called 'finite' classes.

From the fact, however, that we have an employment for a *kind* of numeral which, as it were, gives the number of the members of an infinite series, it does not follow that it also makes some kind of sense to speak of the number of the concept 'infinite series'; that we have *here* some kind of employment for something like a numeral. For there is no grammatical technique suggesting employment of such an expression. For I can of course form the expression: "class of all classes which are equinumerous with the class 'infinite series'" (as also: "class of all angels that can get on to a needlepoint") but this expression is empty so long as there is no employment for it. Such an employment is not: yet to be discovered, but: still to be *invented*.

Page Break 137

Page 137

39. Imagine that I put a playing-board divided into squares in front of you, and put pieces like chess pieces on it--and stated: "This piece is the '*King*', these are the '*Knights*', these the '*Commoners*'.--So far that's all we know about the game; but that's always something.--And perhaps more will be discovered."

Page 137

40. "Fractions cannot be arranged in an order of magnitude."--First and foremost, this sounds extremely interesting and remarkable.

It sounds interesting in a quite different way from, say, a proposition of the differential calculus. The difference, I think, resides in the fact that *such* a proposition is easily associated with an application to physics, whereas *this* proposition belongs simply and solely to mathematics, seems to concern as it were the natural history of mathematical objects themselves.

One would like to say of it e.g.: it introduces us to the mysteries of the mathematical world. *This* is the aspect against which I want to give a warning.

Page 137

41. When it looks as if..., we should look out.

Page 137

42. When, on hearing the proposition that the fractions cannot be arranged in a series in order of magnitude, I form the picture of an unending row of things, and between each thing and its neighbour new things appear, and more new ones again between each of these things and its neighbour, and so on without end, then certainly there is

something here to make one dizzy.

But once we see that this picture, though very exciting, is all the same not appropriate; that we ought not to let ourselves be trapped by the words "series", "order", "exist", and others, we shall fall back on the *technique* of calculating fractions, about which there is no longer anything *queer*.

Page Break 138

Page 138

43. The fact that in a technique of calculating fractions the expression "the next greatest fraction" has no sense, that we have not given it any sense, is nothing to marvel at.

Page 138

44. If we apply a technique of continuous interpolation of fractions, we shall not be willing to call any fraction the "next biggest".

Page 138

45. To say that a technique is unlimited does *not* mean that it goes on without ever stopping--that it increases immeasurably; but that it lacks the institution of the end, that it is not finished off. As one may say of a sentence that it is not finished off if it has no period. Or of a playing-field that is unlimited, when the rules of the game do not prescribe any boundaries--say by means of a line.

Page 138

46. For the point of a new technique of calculation is to supply us with a *new* picture, a *new form of expression*; and there is nothing so absurd as to try and describe this new schema, this new kind of scaffolding, by means of the old expressions.

Page 138

47. What is the function of such a proposition as: "A fraction has not a next biggest fraction but a cardinal number has a next biggest cardinal number"? Well, it is as it were a proposition that compares two games. (Like: in draughts pieces jump over one another, but not in chess.)

Page Break 139

Page 139

48. We call something "constructing the next biggest cardinal number" but nothing "constructing the next biggest fraction".

Page 139

49. How do we compare games? By describing them--by describing one as a variation of another--by describing them and *emphasizing* their differences and analogies.

Page 139

50. "In draughts there isn't a King"--what does this mean? (It sounds childish.) Does it mean that none of the pieces in draughts is called "King"; and if we did call one of the pieces that, would there be a King in draughts? But what about *this* proposition: "In draughts all the pieces have the same rights, but not in chess"? Whom am I telling this? One who already knows both games, or else someone who does not yet know them. Here it looks as if the first one stands in no need of our information and the second can do nothing with it. But suppose I were to say: "See! In draughts all the pieces have the same rights,..." or better still: "See! In these games all the pieces have the same rights, in those not." But what does such a proposition do? It introduces a new *concept*, a new ground of classification. I teach you to answer the question: "Name games of the first sort" etc. But in a similar way it would be possible to set questions like: "Invent a game with a King".

Page 139

51. 'We cannot arrange fractions in a series in order of magnitude but we *can* order them in an infinite series.'
If someone did not know this, what has he now learnt? He has learnt a new kind of calculation, e.g.:
"Determine the number of the fraction

Page Break 140

Page 140

52. He learns this technique--but doesn't he also learn that there is such a technique?
I have indeed, in an important sense, learned that there is such a technique; that is, I have got to know a technique which can now be applied to all sorts of other things.

Page 140

53. 'What would you call *this*'?

	1	2	3	4	•	•	•
1	1	3	6	10	•		
2	2	5	9	•			
3	4	8	•				
4	7	•					
•	•						

Surely "a method of numbering the pairs of numbers"? And might I not also say: "of ordering pairs of numbers in a series"?

Page 140

54. Now does mathematics teach me that I can order the pairs of numbers in a series? Can I say: it teaches me that I can do *this*? For does it make sense to say that I teach a child that it is possible to multiply--by teaching him to multiply? It would rather be natural to say I teach him that it is possible to multiply fractions, after he has learned to multiply cardinal numbers together. For now, it might be said, he knows what "multiplying" means. But wouldn't this be misleading too?

Page 140

55. If someone says I have proved the proposition that we can order pairs of numbers in a series, it should be answered that this is not a mathematical proposition, since one doesn't calculate with the words "we", "can", "the", "pairs of numbers", etc. The proposition

Page Break 141

"one can..." is rather a mere approximate description of the technique one is teaching, say a not unsuitable *title*, a heading to this chapter. But a title with which it is not possible to *calculate*.

Page 141

56. But, you say, this is just what the logical calculus of Frege and Russell does: in it every word that is spoken in mathematics has exact significance, is an element of the calculus. Thus in this calculus we can really prove that "multiplying is possible". Very well, now it is a mathematical proposition; but who says that anything can be done with this proposition? Who says *what* use it can be? For its sounding interesting is not enough.

Just because when we are teaching we may use the proposition "So you see, we can order the fractions in a series", don't say that we have any other use for this proposition than of attaching a memorable picture to this sort of calculation.

If the interest here attaches to the proposition that has been proved, then it attaches to a picture which has an extremely weak justification, but which fascinates us by its queerness, like e.g. the picture of the "direction" of time. It produces a slight reeling of one's thoughts.

Page 141

57. Here I can only say: depart as quickly as possible from this picture, and see the interest of this calculation in its application. (It is as if we were at a masked ball at which every calculation appears in a queer guise.)

Page 141

58. "Ought the word 'infinite' to be avoided in mathematics?" Yes; where it appears to confer a meaning upon the calculus; instead of getting one from it.

Page Break 142

Page 142

59. This way of talking: "But when one examines the calculus there is nothing infinite there" is of course

clumsy--but it means: is it really necessary here to conjure up the picture of the infinite (of the enormously big)? And how is this picture connected with the *calculus*? For its connexion is not that of the picture |||| with 4.

Page 142

60. To act as if one were disappointed to have found nothing infinite in the calculus is of course funny; but not to ask: what is the everyday employment of the word "infinite", which gives it its meaning for us; and what is its connexion with these mathematical calculi?

Page 142

61. Finitism and behaviourism are quite similar trends. Both say, but surely, all we have here is.... Both deny the existence of something, both with a view to escaping from a confusion.

Page 142

62. What I am doing is, not to shew that calculations are wrong, but to subject the *interest* of calculations to a test. I test e.g. the justification for still using the word... here. Or really, I keep on urging such an investigation. I shew that there is such an investigation and what there is to investigate there. Thus I must say, not: "We must not express ourselves like this", or "That is absurd", or "That is uninteresting", but: "Test the justification of this expression in this way". You cannot survey the justification of an expression unless you survey its employment; which you cannot do by looking at some facet of its employment, say a picture attaching to it.

Page Break 143

PART III 1939-40

Page 143

1. 'A mathematical proof must be perspicuous.' Only a structure whose reproduction is an easy task is called a "proof". It must be possible to decide with certainty whether we really have the same proof twice over, or not. The proof must be a configuration whose exact reproduction can be certain. Or again: we must be sure we can exactly reproduce what is essential to the proof. It may for example be written down in two different handwritings or colours. What goes to make the reproduction of a proof is not anything like an exact reproduction of a shade of colour or a hand-writing.

Page 143

It must be easy to write down *exactly* this proof again. This is where a written proof has an advantage over a drawing. The essentials of the latter have often been misunderstood. The drawing of a Euclidian proof may be inexact, in the sense that the straight lines are not straight, the segments of circles not exactly circular, etc. etc. and at the same time the drawing is still an exact proof; and from this it can be seen that this drawing does not--e.g.--demonstrate that such a construction results in a polygon with five equal sides; that what it proves is a proposition of geometry, not one about the properties of paper, compass, ruler and pencil.

[Connects with: proof a *picture* of an experiment.]

Page 143

2. I want to say: if you have a proof-pattern that cannot be taken in, and by a change in notation you turn it into one that can, then you are producing a proof, where there was none before.

Page Break 144

Page 144

Now let us imagine a proof for a Russellian proposition stating an addition like ' $a + b = c$ ', consisting of a few thousand signs. You will say: Seeing whether this proof is correct or not is a purely external difficulty, of no mathematical interest. ("One man takes in easily what someone else takes in with difficulty or not at all" etc. etc..)

The assumption is that the definitions serve merely to abbreviate the expression for the convenience of the calculator; whereas they are part of the calculation. By their aid expressions are produced which could not have been produced without it.

Page 144

3. But how about the following: "While it is true that we cannot--in the ordinary sense--multiply 234 by 537 in the Russellian calculus, still there is a Russellian calculation corresponding to this multiplication."--What kind of correspondence is this? It might be like this: we can carry out this multiplication in the Russellian calculus too, only in a different symbolism,--just as, as we should certainly say, we can carry it out in a different number system. In that case, then, we could e.g. solve the practical problems for which we use that multiplication by means of the calculation in the Russellian calculus too, only in a more roundabout way.

Page 144

Now let us imagine the cardinal numbers explained as 1, 1 + 1, (1 + 1) + 1, ((1 + 1) + 1) + 1, and so on. You say that the definitions introducing the figures of the decimal system are a mere matter of convenience; the

calculation 703000×40000101 could be done in that wearisome notation too. But is that true?--"Of course it's true! I can surely write down, construct, a calculation in that notation corresponding to the calculation in the decimal notation."--But how do I know that it corresponds to it? Well, because I have derived it from the other by a given method.--But now if I look at it again

Page Break 145

half an hour later, may it not have altered? For one cannot command a clear view of it.

Page 145

Now I ask: could we also find out the truth of the proposition $7034174 + 6594321 = 13628495$ by means of a proof carried out in the first notation?--Is there such a proof of this proposition?--The answer is: no.

Page 145

4. But still doesn't Russell teach us *one* way of adding?

Page 145

Suppose we proved by Russell's method that $(\exists a \dots g) (\exists a \dots l) \supset (\exists a \dots s)$ is a tautology; could we reduce our result to $g + l$'s being s ? Now this presupposes that I can take the three bits of the alphabet as representatives of the proof. But does Russell's proof shew this? After all I could obviously also have carried out Russell's proof with groups of signs in the brackets whose sequence made no characteristic impression on me, so that it would not have been possible to represent the group of signs between brackets by its last term.

Page 145

Even assuming that the Russellian proof were carried out with a notation such as $x_1x_2\dots x_{10}x_{11}\dots x_{100}\dots$ as in the decimal notation, and there were 100 members in the first pair of brackets, 300 in the second and 400 in the third, does the proof itself shew that $100 + 300 = 400$?--What if this proof led at one time to this result, and at another to a different one, for example $100 + 300 = 420$? What is

Page Break 146

needed in order to see that the result of the proof, if it is correctly carried out, always depends solely on the last figures of the first two pairs of brackets?

Page 146

But still for small numbers Russell does teach us to add; for then we take the groups of signs in the brackets in at a glance and we can take *them* as numerals; for example 'xy', 'xyz', 'xyzuv'.

Thus Russell teaches us a new calculus for reaching 5 from 2 and 3; and that is true even if we say that a logical calculus is only--frills tacked on to the arithmetical calculus.

Page 146

The *application* of the calculation must take care of itself. And that is what is correct about 'formalism'.

Page 146

The reduction of arithmetic to symbolic logic is supposed to shew the point of application of arithmetic, as it were the attachment by means of which it is plugged in to its application. As if someone were shewn, first a trumpet without the mouthpiece--and then the mouthpiece, which shews how a trumpet is used, brought into contact with the human body. But the attachment which Russell gives us is on the one hand too narrow, on the other hand too wide; too general and too special. The calculation takes care of its own application.

Page 146

We extend our ideas from calculations with small numbers to ones with large numbers in the same kind of way as we imagine that, if the distance from here to the sun *could* be measured with a footrule, then we should get the very result that, as it is, we get in a quite different way. That is to say, we are inclined to take the measurement of length with a footrule as a model even for the measurement of the distance between two stars.

Page Break 147

Page 147

And one says, e.g. at school: "If we imagine rulers stretching from here to the sun..." and seems in this way to explain what we understand by the distance between the sun and the earth. And the use of such a picture is all right, so long as it is clear to us that we can measure the distance from us to the sun, and that we cannot measure it with footrules.

Page 147

5. Suppose someone were to say: "The only real proof of $1000 + 1000 = 2000$ is after all the Russellian one, which shews that the expression... is a tautology"? For can I not prove that a tautology results if I have 1000 members in each of the two first pairs of brackets and 2000 in the third? And if I can prove that, then I can look at it as a proof of the arithmetical proposition.

In philosophy it is always good to put a *question* instead of an answer to a question.

For an answer to the philosophical question may easily be unfair; disposing of it by means of another question is not.

Then should I put a *question* here, for example, instead of the answer that that arithmetical proposition cannot be proved by Russell's method?

$$\begin{matrix} 1 & 2 & 3 \\ (&) & (&) \supset (&) \end{matrix}$$

6. The proof that is a tautology consists in always crossing out a term of the third pair of brackets for a term of (1) or (2). And there are many methods for such collating. Or one might even

say: there are many ways of establishing the success of a 1-1 correlation. One way, for example, would be to construct a star-shaped pattern for the left-hand side of the implication and another one for the right-hand side and then to compare these in their turn by making an ornament out of the two of them.

Thus the rule could be given: "If you want to know whether the numbers A and B together actually yield C, write down an expression of the form... and correlate the variables in the brackets by writing down (or trying to) the proof that the expression is a tautology".

My objection to this is *not* that it is arbitrary to prescribe just this way of collating, but that it cannot be established in this way that $1000 + 1000 = 2000$.

7. Imagine that you had written down a 'formula' a mile long, and you shewed by transformation that it was tautologous ('if *it* has not altered meanwhile', one would have to say). Now we *count* the terms in the brackets or we divide them up and make the expression into one that can be taken in, and it comes out that there are 7566 terms in the first pair of brackets, 2434 in the second, 10000 in the third. Now have I proved that $2434 + 7566 = 10000$?--That depends--one might say--on whether you are certain that the counting has really yielded the number of terms which stood between the brackets in the course of the proof.

Could one say: "Russell teaches us to write as many variables in the third pair of brackets as were in the first two together"? But really: he teaches us to write a variable in (3) for every variable in (1) and (2).

But do we learn from this what number is the sum of two given

numbers? Perhaps it is said: "Of course, for in the third pair of brackets we have the paradigm, the prototype of the new number". But in what sense is ||| the paradigm of a number? Consider how it can be used as such.

8. Above all, the Russellian tautology corresponding to the proposition $a + b = c$ does not shew us in what notation the number c is to be written, and there is no reason why it should not be written in the form $a + b$.--For Russell does not teach us the technique of, say, adding in the decimal system.--But could we perhaps derive it from his technique?

Let us just ask the following question: Can one derive the technique of the decimal system from that of the system $1, 1 + 1, (1 + 1) + 1, \text{ etc.}$?

Could this question not also be formulated as follows: if one has one technique of calculation in the one system and one in the other,--how is it shewn that the two are equivalent?

9. "A proof ought to shew not merely that this is how it is, but this is how it has to be."

In what circumstances does counting shew this?

One would like to say: "When the figures and the thing being counted yield a memorable configuration. When this configuration is now used in place of any fresh counting."--But here we seem to be talking only of *spatial* configurations: but if we know a series of words by heart and then co-ordinate two such series, one to one, saying for example: "First--Monday; second--Tuesday; third--Wednesday;

etc."--can we not *prove* in this way that from Monday to Thursday is four days?

For the question is: What do we call a "memorable configuration"? What is the criterion for its being impressed on our minds? Or is the answer to that: "That we use it as a paradigm of identity!"?

10. We do not make *experiments* on a sentence or a proof in order to establish its properties.

How do we reproduce, how do we copy, a proof?--Not e.g. by taking measurements of it.

Suppose a proof were so hugely long that it could not possibly be taken in? Or let us look at a different case: Let there be a long row of strokes engraved in hard rock which is our paradigm for the number that we call 1000. We call this row the proto-thousand and if we want to know whether there are a thousand men in a square, we draw lines or stretch threads. (1-1 correlation.)

Now here the sign of the number 1000 has the identity, not of a shape, but of a physical object. We could imagine a 'proto-hundred' similarly, and a proof, which we could not *take in at a glance*, that $10 \times 100 = 1000$.

The figure for 1000 in the system of $1 + 1 + 1 + 1...$ cannot be recognized by its *shape*.

11. ||||| |

Is this pattern a proof of $27 + 16 = 43$, because one reaches '27' if one counts the strokes on the left-hand side, '16' on the right-hand

side, and '43' when one counts the whole row?

Where is the queerness of calling the pattern the proof of this proposition? It lies in the kind of way this proof is to be reproduced or known again; in its not having any characteristic visual shape.

Now even if that proof has not any such visual shape, still I can copy (reproduce) it exactly--so isn't the figure a proof after all? I might e.g. have it engraved on a bit of steel and passed from hand to hand. So I should tell someone: "Here you have the proof that $27 + 16 = 43$ ".--Well, can't one say *after all* that he proves the proposition with the aid of the pattern? Yes; but the pattern is not the proof.

This, however, would surely be called a proof of $250 + 3220 = 3470$: one counts on from 250 and at the same time begins counting from 1 and co-ordinates the two counts:

251... 1
252...2
253... 3
etc.

3470.... 3220

That could be called a proof in 3220 steps. It is surely a proof--and can it be called perspicuous?

12. What is the invention of the decimal system really? The invention of a system of abbreviations--but what is the system of the abbreviations? Is it simply the system of the new signs or is it also a

system of applying them for the purpose of abbreviation? And if it is the latter, then it *is* a new way of looking at the old system of signs.

Can we start from the system of $1 + 1 + 1 ...$ and learn to calculate in the decimal system through mere abbreviations of the notation?

13. Suppose that following Russell I have proved a proposition of the form $(\exists xyz...) (\exists uvw...) \supset (\exists abc...)$ --and now 'I make it perspicuous' by writing signs $x_1, x_2, x_3...$ over the variables--am I to say that following Russell I have proved an arithmetical proposition in the decimal system?

But for every proof in the decimal system there is surely a corresponding one in Russell's system!--How do we know there is? Let us leave intuition on one side.--But it can be proved.--

If a number in the decimal system is defined in terms of 1, 2, 3,... 9, 0, and the signs 0, 1... 9 in terms of 1, 1 +

1, $(1 + 1) + 1, \dots$ can one then use the recursive explanation of the decimal system to reach a sign of the form $1 + 1 + 1 \dots$ from any number?

Page 152

Suppose someone were to say: Russellian arithmetic agrees with ordinary arithmetic up to numbers less than 10^{10} ; but then it diverges from it. And now he produces a Russellian proof that $10^{10} + 1 = 10^{10}$. Now why should I not trust such a proof? How will anybody convince me that I must have miscalculated in the Russellian proof?

Page 152

But then do I need a proof from another system in order to ascertain

Page Break 153

whether I have miscalculated in the first proof? Is it not enough for me to write down that proof in a way that makes it possible to take it in?

Page 153

14. Is not my whole difficulty one of seeing how it is possible, without abandoning Russell's logical calculus, to reach the concept of the *set of variables* in the expression ' $(\exists xyz\dots)$ ', where this expression cannot be taken in?--

Well, but it can be made surveyable by writing: $(\exists x_1, x_2, x_3, \text{etc.})$. And still there is something that I do not understand: the criterion for the identity of such an expression has now surely been changed: I now see in a different way that the set of signs in two such expressions is the same.

Page 153

What I am tempted to say is: Russell's proof can indeed be continued step by step, but at the end one does not rightly know what one has proved--at least not by the old criteria. By making it possible to command a clear view of the Russellian proof, I prove something about this proof.

I want to say: one need not acknowledge the Russellian technique of calculation at all--and can prove by means of a different technique of calculation that there *must* be a Russellian proof of the proposition. But in that case, of course, the proposition is no longer based upon the Russellian proof.

Or again: its being possible to imagine a Russellian proof for every proved proposition of the form $m + n = l$ does not shew that the proposition is based on this proof. For it is conceivable that the Russellian proof of one proposition should not be distinguishable from the Russellian proof of another and should be called different only because they are the translations of two recognizably different proofs.

Page Break 154

Page 154

Or again: something stops being a proof when it stops being a paradigm, for example Russell's logical calculus; and on the other hand any other calculus which serves as a paradigm is acceptable.

Page 154

15. It is a fact that different methods of counting practically always agree.

Page 154

When I count the squares on a chess-board I practically always reach '64'.

Page 154

If I know two series of words by heart, for example numerals and the alphabet, and I put them into one-one correspondence:

a 1
b 2
c 3
etc.

at 'z' I practically always reach '26'.

Page 154

There is such a thing as: knowing a series of words by heart. When am I said to know the poem... by heart? The criteria are rather complicated. Agreement with a printed text is one. What would have to happen to make me doubt that I really know the *ABC* by heart? It is difficult to imagine.

But I use reciting or writing down a series of words from memory as a criterion for equality of numbers, equality of sets.

Page Break 155

Page 155

Ought I now to say: all that doesn't matter--logic still remains the fundamental calculus, only whether I have the same formula twice is of course differently established in different cases?

16. It is not logic--I should like to say--that compels me to accept a proposition of the form $(\exists)(\exists) \supset (\exists)$, when there are a million variables in the first two pairs of brackets and two million in the third. I want to say: logic would not compel me to accept any proposition at all in this case. Something *else* compels me to accept such a proposition as in accord with logic.

Logic compels me only so far as the logical calculus compels me.

But surely it is essential to the calculus with 1000000 that this number must be capable of resolution into a sum $1 + 1 + 1 \dots$, and in order to be certain that we have the right number of units before us, we can number the

$1 + 1 + 1 + 1 + \dots + 1$

units: $1 \quad 2 \quad 3 \quad 4 \quad \dots \quad 1000000$. This notation would be like: '100,000.000,000' which also makes the numeral surveyable. And I can surely imagine someone's having a great sum of money in pennies entered in a book in which perhaps they appear as numbers of 100 places, with which I have to calculate. I should now begin to translate them into a surveyable notation, but still I should call them 'numerals', should treat them as a record of numbers. For I should even regard it as the record of a number if someone were to tell me that N has as many shillings as this vessel will hold peas. Another case again: "He has as many shillings as the Song of Songs has letters".

17. The notation ' x_1, x_2, x_3, \dots ' gives a shape to the expression ' $(\exists \dots)$ ', and so to the R-proved tautology.

Let me ask the following question: Is it not conceivable that the 1-1 correlation could not be trustworthily carried out in the Russellian proof, that when, *for example*, we try to use it for adding, we regularly get a result contradicting the usual one, and that we blame this on fatigue, which makes us leave out certain steps unawares? And might we not then say:--if only we didn't get tired we should get the same result--? Because *logic* demands it? Does it demand it, then? Aren't we here rectifying logic by means of another calculus?

Suppose we took 100 steps of the logical calculus at a time and now got trustworthy results, while we don't get them if we try to take all the steps singly--one would like to say: the calculation is still based on unit steps, since 100 steps at a time is defined by means of unit steps.--But the definition says: to take 100 steps at a time is the same thing as..., and yet we take the 100 steps at a time and *not* 100 unit steps.

Still, in the shortened calculation I am obeying a *rule*--and how was this rule justified?--What if the shortened and the unshortened proof yielded different results?

18. What I am saying surely comes to this: I can e.g. define '10' as $1 + 1 + 1 + 1 \dots$ and ' 100×2 ' as ' $2 + 2 + 2 \dots$ ' but I cannot therefore necessarily define ' 100×10 ' as ' $10 + 10 + 10 \dots$ ', nor yet as ' $1 + 1 + 1 + 1 \dots$ '

I can find out that 100×100 equals 10000 by means of a 'shortened' procedure. Then why should I not regard *that* as the original proof procedure?

A shortened procedure tells me what *ought* to come out with the unshortened one. (Instead of the other way round.)

19. "But the calculation is surely based on the unit steps...." Yes; but in a different way. For the procedure of proof is a different one.

I could say for example: $10 = 1 + 1 + 1 + 1 + 1 + 1 + 1 + 1 + 1 + 1$ and in like manner $100 = 10 + 10 + 10 + 10 + 10 + 10 + 10 + 10 + 10 + 10$. Have I not based the definition of 100 on the successive addition of 1? But in the same way as if I had added 100 units? Is there any need at all in my notation for a sign of the form--' $1 + 1 + 1 \dots$ ' with 100 components of the sum?

The danger here seems to be one of looking at the shortened procedure as a pale shadow of the unshortened

one. The rule of counting is not counting.

Page 157

20. What does taking 100 steps of the calculus 'at once' consist in? Surely in one's regarding, not the unit step, but a different step, as decisive.

Page Break 158

Page 158

In ordinary addition of whole numbers in the decimal system we make steps in units, steps in tens, etc. Can one say that the procedure is founded on one of only making unit steps? One might justify it like this: the result of the addition does indeed look so--'7583'; but the explanation of this sign, its meaning, which must ultimately receive expression in its application too, is surely of this sort: $1 + 1 + 1 + 1 + 1$ and so on. But is it so? Must the numerical sign be explained in this way, or this explanation receive expression implicitly in its application? I believe that if we reflect it turns out that that is not the case.

Page 158

Calculating with graphs or with a slide-rule.

Of course when we check the one kind of calculation by the other, we normally get the same result. But if there are several kinds--who says, if they do not agree, which is the proper method of calculation, with its roots at the source of mathematics?

Page 158

21. Where a doubt can make its appearance whether *this* is really the pattern of *this* proof, where we are prepared to doubt the identity of the proof, the derivation has lost its proving power. For the proof serves as a measure.

Page 158

Could one say: it is part of proof to have an accepted criterion for the correct reproduction of a proof?

Page 158

That is to say, e.g.: we must be able to be certain, it must hold as certain for us, that we have not overlooked a sign in the course of the

Page Break 159

proof. That no demon can have deceived us by making a sign disappear without our noticing, or by adding one, etc.

Page 159

One might say: When it can be said: "Even if a demon had deceived us, still everything would be all right", then the prank he wanted to play on us has simply failed of its purpose.

Page 159

22. Proof, one might say, does not merely shew *that* it is like this, but: *how* it is like this. It shows *how* 13 + 14 yield 27.

Page 159

"A proof must be capable of being taken in" means: we must be prepared to use it as our guide-line in judging.

Page 159

When I say "a proof is a picture"--it can be thought of as a cinematographic picture.

Page 159

We construct the proof once for all. A proof must of course have the character of a model.

Page 159

The proof (the pattern of the proof) shews us the result of a procedure (the construction); and we are convinced that a procedure regulated in *this* way always leads to this configuration.

(The proof exhibits a fact of synthesis to us.)

Page Break 160

Page 160

23. When we say that a proof is a model,--we must, of course, not be saying anything new.

Page 160

Proof must be a procedure of which I say: Yes, this is how it has to be; this must come out if I proceed according to this rule.

Page 160

Proof, one might say, must originally be a kind of experiment--but is then taken simply as a picture.

Page 160

If I pour two lots of 200 apples together and count them, and the result is 400, that is not a proof that $200 + 200 = 400$. That is to say, we should not want to take this fact as a paradigm for judging all similar situations.

Page 160

To say: "these 200 apples and these 200 apples come to 400"--means: when one puts them together, none are lost or added, they behave *normally*.

Page 160

24. "This is the model for the addition of 200 and 200"--not: "this is the model of the fact that 200 and 200 added together yield 400". The process of adding *did* indeed yield 400, but now we take this result as the criterion for the correct addition--or simply: for the addition--of these numbers.

Page Break 161

Page 161

The proof must be our model, our picture, of how these operations have a *result*.

Page 161

The 'proved proposition' expresses what is to be read off from the proof-picture.

Page 161

The proof is now our model of correctly counting 200 apples and 200 apples together: that is to say, it defines a new concept: 'the counting of 200 and 200 objects together'. Or, as we could also say: "a new criterion for nothing's having been lost or added".

Page 161

The proof *defines* 'correctly counting together'.

Page 161

The proof is our model for a particular *result's being yielded*, which serves as an object of comparison (yardstick) for real changes.

Page 161

25. The proof convinces us of something--though what interests us is, not the mental state of conviction, but the applications attaching to this conviction.

Page 161

For this reason the assertion that the proof convinces us of the truth of this proposition leaves us cold,--since this expression is capable of the most various constructions.

Page Break 162

Page 162

When I say: "the proof convinces me of something", still the proposition expressing this conviction need not be constructed in the proof. As e.g. we multiply, but do not necessarily write down the result in the form of the proposition ' $\dots \times \dots = \dots$ '. So we shall presumably say: the multiplication gives us this conviction without our ever uttering the *sentence* expressing it.

Page 162

A psychological disadvantage of proofs that construct *propositions* is that they easily make us forget that the *sense* of the result is not to be read off from this by itself, but from the *proof*. In this respect the intrusion of the Russellian symbolism into the proofs has done a great deal of harm.

Page 162

The Russellian signs veil the important forms of proof as it were to the point of unrecognizability, as when a human form is wrapped up in a lot of cloth.

Page 162

26. Let us remember that in mathematics we are convinced of *grammatical* propositions; so the expression, the result, of our being convinced is that we *accept a rule*.

Page 162

Nothing is more likely than that the verbal expression of the result of a mathematical proof is calculated to delude us with a myth.

Page 162

27. I am trying to say something like this: even if the proved mathematical proposition seems to point to a reality outside itself, still it is only the expression of acceptance of a new measure (of reality).

Page Break 163

Page 163

Thus we take the constructability (provability) of this symbol (that is, of the mathematical proposition) as a

sign that we are to transform symbols in such and such a way.

Page 163

We have won through to a piece of knowledge in the proof? And the final proposition expresses this knowledge? Is this knowledge now independent of the proof (is the navel string cut)?--Well, the proposition is now used by itself and without having the proof attached to it.

Page 163

Why should I not say: in the proof I have won through to a *decision*?

Page 163

The proof places this decision in a system of decisions.

Page 163

(I might of course also say: "the proof convinces me that this rule serves my purpose". But to say this might easily be misleading.)

Page 163

28. The proposition proved by means of the proof serves as a rule--and so as a paradigm. For we *go by* the rule.

But does the proof only bring us to the point of going by this rule

Page Break 164

(accepting it), or does it also shew us *how* we are to go by it?

Page 164

For the mathematical proposition is to shew us what it makes SENSE to say.

Page 164

The proof constructs a proposition; but the point is *how* it constructs it. Sometimes, for example, it first constructs a *number* and then comes the proposition that there is such a number. When we say that the construction must *convince* us of the proposition, that means that it must lead us to apply this proposition in such-and-such a way. That it must determine us to accept this as sense, that not.

Page 164

29. What is in common between the purpose of a Euclidean construction, say the bisection of a line, and the purpose of deriving a rule from rules by means of logical inferences?

Page 164

The common thing seems to be that by the construction of a sign I compel the acceptance of a sign.

Page 164

Could we say: "mathematics creates new *expressions*, not new propositions"?

Inasmuch, that is, as mathematical propositions are instruments taken up into the language once for all--and their proof shews the place where they stand.

Page Break 165

Page 165

But in what sense are e.g. Russell's tautologies 'instruments of language'?

Russell at any rate would not have held them to be so. His mistake, if there was one, can however only have consisted in his not paying attention to their *application*.

Page 165

The proof makes one structure generate another.

It exhibits the generation of one from others.

That is all very well--but still it does quite different things in different cases! What is the *interest* of this transition?

Page 165

Even if I think of a proof as something deposited in the archives of language--who says *how* this instrument is to be employed, what it is for?

Page 165

30. A proof leads me to say: this *must* be like this.--Now, I understand this in the case of a Euclidean proof or the proof of '25 times 25 = 625', but is it also like this in the case of a Russellian proof, e.g. of ' $\vdash p \supset q.p : \supset : q$ '? What does 'it *must* be like this' mean here in contrast with 'it is like this'? Should I say: "Well, I accept this expression as a paradigm for all non-informative propositions of this form"?

Page 165

I go through the proof and say: "Yes, this is how it *has* to be; I must fix the use of my language in *this* way".

I want to say that the *must* corresponds to a track which I lay down in language.

31. When I said that a proof introduces a new concept, I meant something like: the proof puts a new paradigm among the paradigms of the language; like when someone mixes a special reddish blue, somehow settles the special mixture of the colours and gives it a name.

But even if we are inclined to call a proof such a new paradigm--what is the exact similarity of the proof to such a concept-model?

One would like to say: the proof changes the grammar of our language, changes our concepts. It makes new connexions, and it creates the concept of these connexions. (It does not establish that they are there; they do not exist until it makes them.)

32. What concept is created by ' $p \supset p$ '? And yet I feel as if it would be possible to say that ' $p \supset p$ ' serves as the sign of a concept.

' $p \supset p$ ' is a formula. Does a formula establish a concept? One can say: "by the formula... such-and-such follows from this". Or again: "such-and-such follows from this in the following way:..." But is that the sort of proposition I want? What, however, about: "Draw the consequences of this in the following way:..."?

33. If I call a proof a model (a picture), then I must also be able to say this of a Russellian primitive proposition (as the egg-cell of a proof).

It can be asked: how did we come to utter the sentence ' $p \supset p$ ' as

a true assertion? Well, it was not used in practical linguistic intercourse,--but still there was an inclination to utter it in particular circumstances (when for example one was doing logic) *with conviction*.

But what about ' $p \supset p$ '? I see in it a degenerate proposition, which is on the side of truth.

I fix it as an important point of intersection of significant sentences. A pivotal point of our method of description.

34. The construction of a proof begins with some signs or other, and among these some, the 'constants', must already have meaning in the language. In this way it is essential that ' \forall ' and ' \sim ' already possess a familiar application, and the construction of a proof in *Principia Mathematica* gets its importance, its sense, from this. But the signs of the proof do *not* enable us to see this meaning.

The 'employment' of the proof has of course to do with that employment of its signs.

35. To repeat, in a certain sense even Russell's primitive propositions convince me.

Thus the conviction produced by a proof cannot simply arise from the proof-construction.

36. If I were to see the standard metre in Paris, but were not

acquainted with the institution of measuring and its connexion with the standard metre--could I say, that I was acquainted with the concept of the standard metre?

Is a proof not also part of an institution in this way?

A proof is an instrument--but why do I say "an instrument of language"?

Is a calculation necessarily an instrument of language, then?

37. What I always do seems to be--to emphasize a distinction between the determination of a sense and the employment of a sense.

38. Accepting a proof: one may accept it as the paradigm of the pattern that arises when *these* rules are

correctly applied to certain patterns. One may accept it as the correct derivation of a rule of inference. Or as a correct derivation from a correct empirical proposition; or as the correct derivation from a false empirical proposition; or simply as the correct derivation from an empirical proposition, of which we do not know whether it is true or false.

Page 168

But now can I say that the conception of a proof as 'proof of constructability' of the proved proposition is in some sense a simpler, more primary, one than any other conception?

Page Break 169

Page 169

Can I therefore say: "Any proof proves *first and foremost* that this formation of signs must result when I apply these rules to these formations of signs"? Or: "The proof proves first and foremost that this formation can arise when one operates with these signs according to these transformation-rules".--

This would point to a geometrical application. For the proposition whose truth, as I say, is proved here, is a geometrical proposition--a proposition of grammar concerning the transformations of signs. It might for example be said: it is proved that it makes *sense* to say that someone has got the sign ... according to these rules from ... and ...; but no sense etc. etc.

Page 169

Or again: when mathematics is divested of all content, it would remain that certain signs can be constructed from others according to certain rules.--

Page 169

The least that we have to accept would be: that these signs etc. etc.--and accepting this is a basis for accepting anything else.

Page 169

I should now like to say: the sequence of signs in the proof does not necessarily carry with it any kind of acceptance. If however it's to be a matter of accepting, this does not have to be 'geometrical' acceptance.

Page 169

A proof could surely consist of only two steps: say one proposition ' $(x).fx$ ' and one ' fa '--does the correct transition according to a rule play an important part here?

Page Break 170

Page 170

39. *What* is unshakably certain about what is proved?

Page 170

To accept a proposition as unshakably certain--I want to say--means to use it as a grammatical rule: this removes uncertainty from it.

Page 170

"Proof must be capable of being taken in" really means nothing but: a proof is not an experiment. We do not accept the result of a proof because it results once, or because it often results. But we see in the proof the reason for saying that this *must* be the result.

Page 170

What *proves* is not that this correlation leads to this result--but that we are persuaded to take these appearances (pictures) as models for what it is like if....

Page 170

The proof is our new model for what it is like if nothing gets added and nothing taken away when we count correctly etc.. But these words shew that I do not quite know what the proof is a model of.

Page 170

I want to say: with the logic of *Principia Mathematica* it would be possible to justify an arithmetic in which $1000 + 1 = 1000$; and all that would be necessary for this purpose would be to doubt the sensible correctness of calculations. But if we do not doubt it, then it is not our conviction of the truth of logic that is responsible.

Page Break 171

Page 171

When we say in a proof: "This *must* come out"--then this is not for reasons that we do not *see*.

Page 171

It is not our getting this result, but its being the end of this route, that makes us accept it.

Page 171

What convinces us--*that* is the proof: a configuration that does not convince us is not the proof, even when it

can be shewn to exemplify the proved proposition.

Page 171

That means: it must not be necessary to make a physical investigation of the proof-configuration in order to shew us what has been proved.

Page 171

40. If we have a picture of two men, we do not say *first* that the one appears smaller than the other, and *then* that he seems to be further away. It is, one can say, perfectly possible that the one figure's being shorter should not strike us at all, but only its being behind. (This seems to me to be connected with the question of the 'geometrical' conception of proof.)

Page 171

41. "It (the proof) is the model for what is called such-and-such."

Page 171

But what is the transition from '(x).fx' to 'fa' supposed to be a model for? At most for how inferences can be drawn from signs like '(x).fx'.

I thought of the model as a justification, but here it is not a justification.

Page Break 172

The pattern $(x).fx \therefore fa$ does not *justify* the conclusion. If we want to talk about a justification of the conclusion, it lies outside this schema of signs.

Page 172

And yet there is something in saying that a mathematical proof creates a new concept.--Every proof is as it were an avowal of a particular employment of signs.

Page 172

But what is it an avowal of? Only of *this* employment of the rules of transition from formula to formula? Or is it also an avowal in some sense, of the 'axioms'?

Page 172

Could I say: I avow $p \supset p$ as a tautology?

Page 172

I accept ' $p \supset p$ ' as a maxim, e.g. of inference.

Page 172

The idea that proof creates a new concept might also be roughly put as follows: a proof is not its foundations plus the rules of inference, but a *new* building--although it is an example of such and such a style. A proof is a *new* paradigm.

Page 172

The concept which the proof creates may for example be a new concept of inference, a new concept of correct inferring. But as for *why* I accept this as *correct* inferring, the reasons for that lie outside the proof.

Page Break 173

Page 173

The proof creates a new concept by creating or being a new sign. Or--by giving the proposition which is its result a new place. (For the proof is not a movement but a route.)

Page 173

42. It must not be *imaginable* for *this* substitution in *this* expression to yield anything else. Or: I must declare it unimaginable. (The result of an experiment, however, can turn out this way or that.)

Page 173

Still, the case could be imagined in which a proof altered in appearance--engraved in rock, it is stated to be the same whatever the appearance says.

Page 173

Are you really saying anything but: a proof is taken as *proof*?

Page 173

Proof must be a procedure plain to view. Or again: the proof is the procedure that is *plain to view*.

Page 173

It is not something behind the proof, but the proof, that proves.

Page 173

43. When I say: "it must first and foremost be evident that *this* substitution really yields *this* expression"--I might also say: "I must accept it as indubitable"--but then there must be good reasons for this: for example, that the same substitution practically always yields

Page Break 174

the same result etc.. And isn't this exactly what surveyability consists in?

Page 174

I should like to say that where surveyability is not present, i.e. where there is room for a doubt whether what we have really is the result of this substitution, the *proof* is destroyed. And not in some silly and unimportant way that has nothing to do with the *nature* of proof.

Page 174

Or: logic as the foundation of all mathematics does not work, and to shew this it is enough that the cogency of logical proof stands and falls with its geometrical cogency.†1

Page 174

We incline to the belief that *logical* proof has a peculiar, absolute cogency, deriving from the unconditional certainty in logic of the fundamental laws and the laws of inference. Whereas propositions proved in this way can after all not be more certain than is the correctness of the way those laws of inference are *applied*.

Page 174

That is to say: logical proof, e.g. of the Russellian kind, is cogent only so long as it also possesses geometrical cogency.†1 And an abbreviation of such a logical proof may have this cogency and so be a proof, when the Russellian construction, completely carried out, is not.

Page Break 175

Page 175

The logical certainty of proofs--I want to say--does not extend beyond their geometrical certainty.

Page 175

44. Now if a proof is a model, then the point must be what is to count as a correct reproduction of the proof.

Page 175

If, for example, the sign '|||||||' were to occur in a proof, it is not clear whether merely 'the same number' of strokes (or perhaps little crosses) should count as the reproduction of it, or whether some other, not too small, number does equally well. Etc.

Page 175

But the question is what is to count as the criterion for the reproduction of a proof--for the identity of proofs. How are they to be compared to establish the identity? Are they the same if they look the same?

Page 175

I should like, so to speak, to shew that we can get away from logical proofs in mathematics.

Page 175

45. "By means of suitable definitions, we can prove ' $25 \times 25 = 625$ ' in Russell's logic."--And can I define the ordinary technique of proof by means of Russell's? But how can one technique of proof be *defined* by means of another? How can one explain the *essence* of another? For if the one is an 'abbreviation' of the other, it must surely be a *systematic*

Page Break 176

abbreviation. Proof is surely required that I can systematically shorten the long proofs and thus once more get a system of proofs.

Long proofs at first always go along with the short ones and as it were tutor them. But in the end they can no longer follow the short ones and these shew their independence.

Page 176

The consideration of *long* unsurveyable logical proofs is only a means of shewing how this technique--which is based on the geometry of proving--may collapse, and new techniques become necessary.

Page 176

46. I should like to say: mathematics is a MOTLEY of techniques of proof.--And upon this is based its manifold applicability and its importance.

Page 176

But that comes to the same thing as saying: if you had a system like that of Russell and produced systems like the differential calculus out of it by means of suitable definitions, you would be producing a new bit of mathematics.

Page 176

Now surely one could simply say: if a man had invented calculating in the decimal system--that would have

been a mathematical invention!--Even if he had already got Russell's *Principia Mathematica*--

Page 176

What is it to co-ordinate one system of proofs with another? It involves a translation rule by means of which proved propositions of

Page Break 177

the one can be translated into proved propositions of the other.

Now it is possible to imagine some--or all--of the proof systems of present-day mathematics as having been co-ordinated in such a way with one system, say that of Russell. So that all proofs could be carried out in this system, even though in a roundabout way. So would there then be only the single system--no longer the many?--But then it must surely be possible to shew of the *one* system that it can be resolved into the many.--*One* part of the system will possess the properties of trigonometry, another those of algebra, and so on. Thus one *can* say that different techniques are used in these parts.

Page 177

I said: whoever invented calculation in the decimal notation surely made a mathematical discovery. But could he not have made this discovery all in Russellian symbols? He would, so to speak, have discovered a new *aspect*.

Page 177

"But in that case the truth of true mathematical propositions can still be proved from those general foundations."--It seems to me there is a snag here. When do we say that a mathematical proposition is true?--

Page 177

It seems to me as if we were introducing new concepts into the Russellian logic without knowing it.--For example, when we settle what signs of the form ' $\exists x, y, z...$ ' are to count as equivalent to one another, and what are not to count as equivalent.

Is it a matter of course that ' $\exists x, y, z$ ' is not the same sign as ' $\exists x, y, z, n$ '?

Page Break 178

Page 178

But suppose I first introduce ' $p \vee q$ ' and ' $\sim p$ ' and use them to construct some tautologies--and then produce (say) the series $\sim p, \sim\sim p, \sim\sim\sim p$, etc. and introduce a notation like $\sim^1 p, \sim^2 p, \dots \sim^{10} p \dots$. I should like to say: we should perhaps originally never have thought of the possibility of such a sequence and we have now introduced a new concept into our calculation. Here is a 'new aspect'.

Page 178

It is clear that I could have introduced the concept of number in this way, even though in a very primitive and inadequate fashion--but this example gives me all I need.

Page 178

In what sense can it be correct to say that one would have introduced a new concept into logic with the series $\sim p, \sim\sim p, \sim\sim\sim p$, etc.?--Well, first of all one could be said to have done it with the '*etc.*'. For this '*etc.*' stands for a law of sign formation which is new to me. A characteristic mark of this is the fact that *recursive* definition is required for the explanation of the decimal notation.

Page 178

A new *technique* is introduced.

Page 178

It can also be put like this: having the concept of the Russellian formation of proofs and propositions does *not* mean you have the concept of every *series* of Russellian signs.

Page Break 179

Page 179

I should like to say: Russell's foundation of mathematics postpones the introduction of new techniques--until finally you believe that this is no longer necessary at all.

Page 179

(It would perhaps be as if I were to philosophize about the concept of measurement of length for so long that people forgot that the actual fixing of a unit of length is necessary before you can measure length.)

Page 179

47. Can what I want to say be put like *this*: "If we had learnt from the beginning to do all mathematics in Russell's system, the differential calculus, for example, would not have been invented just by our having Russell's calculus. So if someone discovered this kind of calculation *in Russell's calculus*----."

Page 179

Suppose I had Russellian proofs of the propositions

$$'p \equiv \sim\sim p'$$

$$' \sim p \equiv \sim\sim\sim p'$$

$$'p \equiv \sim\sim\sim\sim p'$$

and I were now to find a shortened way of proving the proposition

$$'p \equiv \sim 10p'.$$

It is as if I had discovered a new kind of calculation within the old calculus. What does its having been discovered consist in?

Page 179

Tell me: have I discovered a new kind of calculation if, having once learnt to multiply, I am struck by multiplications with all the factors the same, as a special branch of these calculations, and so I introduce the notation ' $a^n = \dots$ '?

Page Break 180

Page 180

Obviously the mere 'shortened', or *different*, notation--' 16^2 ' instead of ' 16×16 '--does not amount to that. What is important is that we now merely *count* the factors.

Is ' 16^{15} ' merely another notation for ' $16 \times 16 \times 16 \times 16 \times 16 \times 16 \times 16 \times 16 \times 16 \times 16 \times 16 \times 16 \times 16 \times 16 \times 16$ '?

Page 180

The proof that $16^{15} = \dots$ does not simply consist in my multiplying 16 by itself fifteen times and getting this result--the proof must shew that I take the number as a factor 15 times.

Page 180

When I ask "What is new about the 'new kind of calculation'--exponentiation"--that is difficult to say. The expression 'new aspect' is vague. It means that we now look at the matter differently--but the question is: what is the essential, the *important* manifestation of this 'looking at it differently'?

First of all I want to say: "It need never have *struck* anyone that in certain products all the factors are equal"--or: "Product of all equal factors' is a new concept"--or: "What is new consists in our classifying calculations differently". In exponentiation the essential thing is evidently that we look at the *number* of the factors. But who says we ever attended to the number of factors? It *need* not have struck us that there are products with 2, 3, 4 factors etc. although we have often worked out such products. A new aspect--but once more: what is *important* about it? For what purpose do I use what has struck me?--Well, first of all perhaps I put it down in a notation. Thus I write e.g. ' a^2 ' instead of ' $a \times a$ '. By this means I refer to the series of numbers (allude to it), which did not happen before. So I am surely setting up a new connexion!--A connexion--between what objects? Between the technique of counting factors and the technique of multiplying.

Page Break 181

Page 181

But in that way every proof, each individual calculation makes new connexions!

Page 181

But the *same* proof as shews that $a \times a \times a \times \dots = b$, surely also shews that $a^n = b$; it is only that we have to make the transition according to the definition of ' a^n '.--

But this transition is exactly what is new. But if it is only a transition to the old proof, how can it be important?

Page 181

'It is only a different notation.' Where does it stop being--just a different notation?

Page 181

Isn't it where only the one notation and not the other can be used in such-and-such a way?

Page 181

It might be called "finding a new aspect", if someone writes ' $a(f)$ ' instead of ' $f(a)$ '; one might say: "He *looks at* the function as an argument of its argument". Or if someone wrote ' $\times(a)$ ' instead of ' $a \times a$ ' one could say: "he looks at what was previously regarded as a special case of a function with two argument places as a function with *one* argument place".

If anyone does this he has certainly altered the aspect in a sense, he has for example classified *this* expression with others, compared it with others, with which it was not compared before.--But now, is that an

important change of aspect? *No*, not so long as it does not have certain consequences.

Page Break 182

Page 182

It is true enough that I changed the aspect of the logical calculation by introducing the concept of the *number* of negations: "I never looked at it like that"--one might say. But this alteration only becomes important when it connects with the application of the sign.

Page 182

Conceiving one foot as *12 inches* would indeed mean changing the aspect of 'a foot', but this change would only become important if one now also *measured* lengths in inches.

Page 182

If you introduce the counting of negation signs, you bring in a new way of reproducing signs.

Page 182

For arithmetic, which does talk about the equality of numbers, it is indeed a matter of complete indifference how equality of number of two classes is established--but for its inferences it is not indifferent how its signs are compared with one another, and so e.g. what is the method of establishing whether the number of figures in two numerical signs is the same.

Page 182

It is not the introduction of numerical signs as abbreviations that is important, but the *method* of counting.

Page 182

48. I want to give an account of the motley of mathematics.

Page 182

49. "I can carry out the proof that $127 : 18 = 7.05$ in Russell's system too." Why not.--But must the same result be reached in the

Page Break 183

Russellian proof as in ordinary division? The two are of course connected by means of a type of *calculation* (by rules of translation, say--); but still, is it not risky to work out the division by the new technique,--since the truth of the result is now dependent on the geometry of the rendering?

Page 183

But now suppose someone says: "Nonsense--such considerations play no part in mathematics".--

Page 183

--But the question is not one of uncertainty, for we *are* certain of our conclusions, but of whether we are still doing (Russellian) logic when we e.g. divide.

Page 183

50. Trigonometry has its original importance in connexion with measurements of lengths and angles: it is a bit of mathematics adapted to employment on measurements of lengths and angles.

Applicability to this field might also be called an 'aspect' of trigonometry.

Page 183

When I divide a circle into equal sectors and determine the cosine of one of these sectors by measurement--is that a calculation or an experiment?

Page 183

If a calculation--is it SURVEYABLE?

Is calculation with a slide-rule *surveyable*?

Page Break 184

Page 184

If the cosine of an angle has to be determined by measurement, is a proposition of the form ' $\cos \alpha = n$ ' a *mathematical* proposition? What is the criterion for this decision? Does the proposition say something external about our rulers etc.; or something internal about our concepts?--How is this to be decided?

Page 184

Do the figures (drawings) in trigonometry belong to pure mathematics, or are they only examples of a possible *application*?

Page 184

51. If there is something true about what I am trying to say, then--e.g.--calculating in the decimal notation must have its own life.--One can of course represent any decimal number in the form:

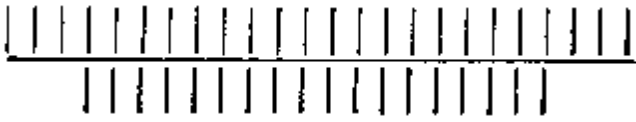

and hence carry out the four species of calculation in this notation. But the life of the decimal notation would have to be independent of calculating with unit strokes.

Page 184

52. In this connexion the following point constantly occurs to me: while indeed a proposition ' $a: b = c$ ' can be *proved* in Russell's logic, still that logic does not teach us to construct a correct sentence of this form, i.e. does not teach us to *divide*. The procedure of dividing would correspond e.g. to that of a *systematic testing* of Russellian proofs with a view, say, to getting the proof of a proposition of the form ' $37 \times 15 = x$ '. "But the technique of such a systematic testing is in its turn founded on logic. It can surely be logically proved in turn that

Page Break 185

this technique must lead to the goal." So it is like proving in Euclid that such-and-such can be constructed in such-and-such a way.

Page 185

53. If someone tries to shew that mathematics is not logic, what is he trying to shew? He is surely trying to say something like:--If tables, chairs, cupboards, etc. are swathed in enough paper, certainly they will look spherical in the end.

Page 185

He is not trying to shew that it is impossible that, for every mathematical proof, a Russellian proof can be constructed which (somehow) 'corresponds' to it, but rather that the acceptance of such a correspondence does not lean on logic.

Page 185

"But surely we can always go back to the primitive logical method!" Well, assuming that we can--how is it that we don't *have* to? Or are we hasty, reckless, if we do not?

But how do we get back to the primitive expression? Do we e.g. take the route through the secondary proof and back from the end of it into the primary system, and then look to see where we have got; or do we go forward in both systems and then connect the end points? And how do we know that we reach the same result in the primary system in the two cases?

Does not proceeding in the secondary system carry the power of conviction with it?

Page 185

"But at every step in the secondary system, we can imagine that it

Page Break 186

could be taken in the primary one too!"--That is just it: *we can imagine that it could be done*--without doing it.

Page 186

And why do we accept the one in place of the other? On grounds of *logic*?

Page 186

"But can't one prove logically that both transformations must lead to the same result?"--But what is in question here is surely the result of transformations of signs! How can logic decide this?

Page 186

54. How can the proof in the stroke system prove that the proof in the decimal system is a proof?

Page 186

Well--isn't it the same for the proof in the decimal system, as it is for a *construction* in Euclid of which it is proved that it really is the construction of such-and-such a figure?

Page 186

Can I put it like this: "The translation of the stroke system into the decimal system presupposes a recursive definition. This definition, however, does not introduce the abbreviation of *one* expression to another. Yet of course inductive proof in the decimal system does not contain the whole set of those signs which would have to be translated by means of the recursive definition into stroke signs. Therefore this general proof cannot be translated by recursive definition into a proof in the stroke system."?

Page Break 187

Page 187

Recursive definition introduces a new sign-technique.--It must therefore make the transition to a new

'geometry'. We are taught a new method of recognizing signs. A new criterion for the identity of signs is introduced.

Page 187

55. A proof shews us what OUGHT to come out.--And since every reproduction of the proof must demonstrate the same thing, while on the one hand it must reproduce the result automatically, on the other hand it must also reproduce the *compulsion* to get it.

That is: we reproduce not merely the *conditions* which once yielded this result (as in an experiment), but the result itself. And yet the proof is not a stacked game, inasmuch as it must always be capable of guiding us.

Page 187

On the one hand we must be able to reproduce the proof *in toto* automatically, and on the other hand this reproduction must once more be *proof* of the result.

Page 187

"Proof must be surveyable": this aims at drawing our attention to the difference between the concepts of 'repeating a proof', and 'repeating an experiment'. To repeat a proof means, not to reproduce the conditions under which a particular result was once obtained, but to repeat every step *and the result*. And although this shews that proof is something that must be capable of being reproduced *in toto* automatically, still every such reproduction must contain the force of proof, which compels acceptance of the result.

Page Break 188

Page 188

56. When do we say that one calculus 'corresponds' to another, is only an abbreviated form of the first?--"Well, when the results of the latter can be translated by means of suitable definitions into the results of the former." But has it been said how one is to calculate with these definitions? What makes us accept this translation? Is it a stacked game in the end? It is, if we are decided on only accepting the translation that leads to the accustomed result.

Page 188

Why do we call a part of the Russellian calculus the part corresponding to the differential calculus?--Because the propositions of the differential calculus are proved in it.--But, ultimately, after the event.--But does that matter? Sufficient that proofs of these propositions can be found in the Russellian system! But aren't they proofs of these propositions only when their results can be translated only into *these* propositions? But is that true even in the case of multiplying in the stroke system with numbered strokes?

Page 188

57. Now it must be clearly stated that calculations in the stroke notation will normally always agree with those in the decimal notation. Perhaps, in order to make sure of agreement, we shall at some point have to take to getting the stroke-calculation worked over by *several* people. And we shall do the same for calculations with still higher numbers in the decimal system.

But that of course is enough to shew that it is not the proofs in the stroke notation that make the proofs in the decimal system cogent.

Page Break 189

Page 189

"Still, if we did not have the latter, we could use the former to prove the same thing."--The same thing? What is the same thing?--Well, the stroke proof will convince me of the same thing, though not in the same way.--Suppose I were to say: "The place to which a proof leads us cannot be determined independently of this proof."--Did a proof in the stroke system demonstrate to me that the proved proposition possesses the applicability given it by the proof in the decimal system--was it e.g. proved in the stroke system that the proposition is also provable in the decimal system?

Page 189

58. Of course it would be nonsense to say that *one* proposition cannot have two proofs--for we do say just that. But can we not say: *this* proof shews that... results when we do *this*; the other proof shews that this expression results when we do something else?

For is e.g. the mathematical fact that 129 is divisible by 3 independent of the fact that *this* is the result in *this* calculation? I mean: is the fact of this divisibility independent of the *calculus* in which it is a result; or is it a fact of this calculus?

Page 189

Suppose it were said: "By calculating we get acquainted with the properties of numbers".

But do the properties of numbers *exist* outside the calculating?

Page 189

"Two proofs prove the same when what they convince me of is the same."--And when is what they convince me of the same?--How do I know that what they convince me of is the same? Not of course by introspection.

Page Break 190

Page 190

I can be brought to accept this rule by a variety of paths.

Page 190

59. "Each proof proves not merely the truth of the proposition proved, but also that it can be proved *in this way*."--But this latter can also be proved in another way.--"Yes, but the proof proves this in a particular way and in doing so proves that it can be demonstrated in this way."--But even *that* could be shewn by means of a different proof.--"Yes, but then not in this way."--

But this means e.g.: this proof is a mathematical entity that cannot be replaced by any other; one can say that it can convince us of something that nothing else can, and this can be given expression by our assigning to it a proposition that we do not assign to any other proof.

Page 190

60. But am I not making a crude mistake? For just this is essential to the propositions of arithmetic and to the propositions of the Russellian logic: various proofs lead to them. Even: infinitely many proofs lead to any one of them.

Page 190

Is it correct to say that every proof demonstrates something to us which it alone can demonstrate? Would not--so to speak--the proved proposition then be superfluous, and the proof itself also be the thing proved?

Page 190

Is it only the proved proposition that the proof convinces me of?

Page Break 191

Page 191

What is meant by: "A proof is a mathematical entity which cannot be replaced by any other"? It surely means that every single proof has a usefulness which no other one has. It might be said: "--that every proof, even of a proposition which has already been proved, is a contribution to mathematics". But why is it a contribution if its only point was to prove the proposition? Well, one can say: "the new proof shews (or *makes*) a new connexion". (But in that case is there not a mathematical proposition saying that this connexion exists?)

Page 191

What do we *learn* when we see the new proof--apart from the proposition, which we already know anyhow? Do we learn something that cannot be expressed in a mathematical proposition?

Page 191

61. How far does the application of a mathematical proposition depend on what is allowed to count as a proof of it and what is not?

Page 191

I can surely say: if the proposition ' $137 \times 373 = 46792$ ' is true in the ordinary sense, *then there must be a multiplication-sum*, at the ends of which stand the two sides of this equation. And a multiplication-sum is a pattern satisfying certain rules.

I want to say: if I did not accept the multiplication-sum as *one* proof of the proposition, then that would mean that the application of the proposition to multiplication-sums would be gone.

Page 191

62. Let us remember that it is not enough that two proofs meet in the same propositional sign. For how do we know that this sign

Page Break 192

says the same thing both times? *That* must proceed from other connexions.

Page 192

63. The *exact* correspondence of a correct (convincing) transition in music and in mathematics.

Page 192

64. Suppose I were to set someone the problem: "Find a proof of the proposition..."--The answer would surely be to shew me certain signs. Very well: *what* condition must these signs satisfy? They must be a proof of that proposition--but is that, say, a *geometrical* condition? Or a psychological one? Sometimes it could be called a geometrical condition; where the means of proof are already prescribed and all that is being looked for is a particular arrangement.

65. Are the propositions of mathematics anthropological propositions saying how we men infer and calculate?--Is a statute book a work of anthropology telling how the people of this nation deal with a thief etc.?--Could it be said: "The judge looks up a book about anthropology and thereupon sentences the thief to a term of imprisonment"? Well, the judge does not USE the statute book as a manual of anthropology.

66. The prophecy does *not* run, that a man will get *this* result when he follows this rule in making a transformation--but that he will get this result, when we *say* that he is following the rule.

What if we said that mathematical propositions were prophecies in *this* sense: they predict what result members of a society who have learnt this technique will get in agreement with other members of the society? '25 × 25 = 625' would thus mean that men, if we judge them to obey the rules of multiplication, will reach the result 625 when they multiply 25 × 25.--That this is a correct prediction is beyond doubt; and also that calculating is in essence founded on such predictions. That is to say, we should not call something 'calculating' if we could not make such a prophecy with certainty. This really means: calculating is a technique. And what we have said pertains to the essence of a technique.

67. This consensus belongs to the essence of *calculation*, so much is certain. I.e.: this consensus is part of the phenomenon of our calculating.

In a technique of *calculating* prophecies must be possible.

And that makes the technique of calculating similar to the technique of a *game*, like chess.

But what about this consensus--doesn't it mean that *one* human being by himself could not calculate? Well, *one* human being could at any rate not calculate just *once* in his life.

It might be said: all *possible* positions in chess can be conceived as propositions saying that they (themselves) are *possible* positions, or again as prophecies that people will be able to reach these positions

by moves which they agree in saying are in accordance with the rules. A position *reached* in this way is then a proved proposition of this kind.

"A calculation is an experiment."--A calculation can be an experiment. The teacher makes the pupil do a calculation in order to see whether he can calculate; that is an experiment.

When the stove is lit in the morning, is that an experiment? But it could be one.

And in the same way moves in chess are *not* proofs either, and chess positions are not propositions. And mathematical propositions are not positions in a game. And in *this* way they are not prophecies either.

68. If a calculation is an experiment, then what is a mistake in calculation? A mistake in the experiment? Surely not; it would have been a mistake in the experiment, if I had not observed the *conditions* of the experiment--if, e.g., I had made someone calculate when a terrible noise was going on.

But why should I not say: while a mistake in calculating is not a *mistake* in the experiment, still, it is a *miscarriage* of the experiment--sometimes explicable, sometimes inexplicable?

69. "A calculation, for example a multiplication, is an experiment: *we do not know what will result* and we learn it once the multiplication is done."

--Certainly; nor do we know when we go for a walk where exactly we shall be in five minutes' time--but does that make going for a walk into an experiment?--Very well; but in the calculation I surely wanted from the beginning to know what the result was going to be; *that* was what I was interested in. I am, after all, curious about the result. Not,

however, as what I am *going* to say, but as what I *ought* to say.

Page 195

But isn't this just what interests you about this multiplication--how the generality of men will calculate? No--at least not usually--even if I am running to a common meeting point with everybody else.

But surely this is just what the calculation shews me experimentally--where this meeting point is. I as it were let myself unwind and see where I get. And the correct multiplication is the pattern of the way we all work, when we are wound up like *this*.

Page 195

Experience teaches that we all find this calculation correct.

Page 195

We let ourselves unwind and get the result of the calculation. But now--I want to say--we aren't interested in having--under such and such conditions say--actually produced this result, but in the pattern of our working; it interests us as a convincing, harmonious, pattern--not, however, as the result of an experiment, but as a *path*.

Page 195

We say, not: "So *that's* how we go!", but: "So *that's* how it goes!"

Page Break 196

Page 196

70. In what we accept we all work the same way, but we do not make use of this identity merely to predict what people will accept. Just as we do not *use* the proposition "this notebook is red" only to predict that most people will call it 'red'.

Page 196

"And that's what we *call* 'the same'." If there did not exist an agreement in what we call 'red', etc. etc., language would stop. But what about the agreement in what we call 'agreement'?

We can describe the phenomenon of a confusion of language; but what are our tokens of confusion of language? Not necessarily tumult and muddle in action. But rather that, e.g. I am lost when people talk, I cannot react in agreement with them.

Page 196

"For me this is not a language-game." But in this case I might also say: though they accompany their actions with spoken sounds and I cannot call their actions 'confused', still they haven't a *language*--But perhaps their actions would become confused if they were prevented from emitting those sounds.

Page 196

71. It could be said: a proof helps communication. An experiment presupposes it.
Or even: a mathematical proof moulds our language.

Page 196

But it surely remains the case that we can use a mathematical proof to make scientific predictions about the proving done by other people.--

Page Break 197

Page 197

If someone asks me: "What colour is this book?" and I reply: "It's green"--might I as well have given the answer: "The generality of English-speaking people call that 'green'"?

Might he not ask: "And what do *you* call it?" For he wanted to get my reaction.

Page 197

The limits of empiricism.†1

Page 197

72. But there is such a thing as a science of conditioned calculating reflexes;--is that mathematics? That science will rely on experiments: and these experiments will be *calculations*. But suppose this science became quite exact and in the end even a 'mathematical' science?

Now is the result of these experiments that human beings agree in their calculations, or that they agree in what they call "agreeing"? And it goes on like that.

Page 197

It could be said: that science would not function if we did not agree regarding the idea of agreement.

Page 197

It is clear that we can make use of a mathematical work for a study in anthropology. But then one thing is not clear:--whether we

ought to say: "This writing shews us how operating with signs was done among these people", or: "This writing shews us what parts of mathematics these people had mastered".

73. Can I say, on reaching the end of a multiplication: "So *this* is what I agree with!--"?--But can I say it at a single *step* of the multiplication? E.g. at the step ' $2 \times 3 = 6$ '? Any more than I can say: "So this is what I call '*white*'!", looking at this paper?

It seems to me it would be a similar case if someone were to say: "When I call to mind what I have done to-day, I am making an experiment (starting myself off), and the memory that then comes serves to shew me what other people, who saw me, will reply to the question what I did".

What would happen if we rather often had this: we do a calculation and find it correct; then we do it again and find it isn't right; we believe we overlooked something before--then when we go over it again our second calculation doesn't seem right, and so on.

Now should I call this calculating or not?--At any rate he cannot use this calculation to predict that he will land there again next time.--But could I say that he calculated *wrong* this time, because the next time he did not calculate again the same way? I might say: where *this* uncertainty existed there would be no calculating.

But on the other hand I say again: 'Calculating is right--as it is done'. There *can* be no mistake of calculation in ' $12 \times 12 = 144$ '. Why? This proposition has assumed a place among the rules.

But is ' $12 \times 12 = 144$ ' the assertion that it is natural to all men to work out 12×12 in such a way that the answer is 144?

74. If I go over a calculation several times so as to be sure of having done it right, and if I then accept it as correct,--haven't I repeated an experiment so as to be sure that I shall tick the same way the next time?--But why should going over the calculation three times convince me that I shall tick the same way the fourth time?--I'd say: I went over the calculation 'so as to be sure of not having overlooked anything'.

The danger here, I believe, is one of giving a justification of our procedure where there is no such thing as a justification and we ought simply to have said: *that's how we do it*.

When somebody makes an experiment repeatedly 'always with the same result', has he at the same time made an experiment which tells him *what* he will call 'the same result', i.e. how he uses the word "the same"? If you measure a table with a yardstick, are you also measuring the yardstick? If you are measuring the yardstick, then you cannot be measuring the table at the same time.

Suppose I were to say: "When someone measures the table with a yardstick he is making an experiment which tells him the results of measuring this table with *all other* yardsticks"? It is after all beyond doubt that a measurement with one yardstick can be used to predict the results of measurement with others. And, further, that if it could

not--our whole system of measuring would collapse.

No yardstick, it might be said, would be correct, if in general they did not agree.--But when I say that, I do not mean that then they would all be *false*.

75. Calculating would lose its point, if *confusion* supervened. Just as the use of the words "green" and "blue" would lose its point. And yet it seems to be nonsense to say--that a proposition of arithmetic *asserts* that there will not be confusion.--Is the solution simply that the arithmetical proposition would not be *false* but useless, if confusion supervened?

Just as the proposition that this room is 16 foot long would not become *false*, if rulers and measuring fell into confusion. Its sense, not its truth, is founded on the regular working of measurements. (But don't be dogmatic here. There are transitional cases which complicate the discussion.)

Suppose I were to say: an arithmetical proposition expresses confidence that confusion will not supervene. Then the use of all words expresses confidence that confusion will not supervene.

Page 200

We cannot say, however, that use of the word "green" signifies that confusion will not supervene--because then the use of the word "confusion" would have in its turn to assert just the same thing about *this* word.

Page 200

If ' $25 \times 25 = 625$ ' expresses the confidence that we shall always find it easy to agree on taking the road that ends with this proposition--

Page Break 201

then why doesn't this last clause express confidence in something different, viz. that we should always be able to agree about *its* use?

Page 201

We do not play the same language-game with the two propositions.

Page 201

Or can one equally well be confident that one will see the same colour over there as here--and also: that one will be inclined to call the colour the same, if it is the same?

Page 201

What I want to say is: mathematics as such is always measure, not thing measured.

Page 201

76. The concept of calculating excludes *confusion*.--Suppose someone were to get different results at different times when he did a multiplication, and saw this, but found it all right?--But then surely he could not use the multiplication for the same purposes as we!--Why not? Nor is there anything to say that he would necessarily fare ill if he did.

Page 201

The conception of calculation as an experiment tends to strike us as the only *realistic* one.

Page 201

Everything else, we think, is moonshine. In an experiment we have

Page Break 202

something tangible. It is almost as if one were to say: "When a poet composes he is making a psychological experiment; that is the only way of explaining how a poem can have value". We mistake the nature of '*experiment*',--believing that whenever we are keen on knowing the end of a process, it is what we call an "experiment".

Page 202

It looks like obscurantism to say that a calculation is not an experiment. And in the same way so does the statement that mathematics does not *treat* of signs, or that pain is not a form of behaviour. But only because people believe that one is asserting the existence of an intangible, i.e. a shadowy, object side by side with what we all can grasp. Whereas we are only pointing to different modes of employment of words.

It is almost as if one were to say: 'Blue' has to stand for a blue object--otherwise we could not see what the word was for.

Page 202

77. I have invented a game--realize that whoever begins must always win: so it isn't a game. I alter it; now it is all right.

Did I make an experiment, whose result was that whoever begins must always win? Or that we are inclined to play in such a way that this happens? No.--But the result was not what you would have expected! Of course not; but that does not make the game into an experiment.

Page 202

But what does it mean not to know *why* it always has to work out like that? Well, it is because of the rules.--I want to know how I must alter the rules in order to get a proper game.--But you can e.g. alter them *entirely*--and so give a quite different game in place of this

Page Break 203

one.--But that is not what I want. I want to keep the general outline of the rules and only eliminate a mistake.--But that is vague. It is now simply *not clear* what is to be considered as the mistake.

Page 203

It is almost like when one says: What is the mistake in this piece of music? It doesn't sound well on the

instruments.--Now the mistake is not necessarily to be looked for in the instrumentation; it *could* be looked for in the themes.

Page 203

Let us suppose, however, that the game is such that whoever begins can always win by a particular simple trick. But this has not been realized;--so it is a game. Now someone draws our attention to it;--and it stops being a game.

Page 203

What turn can I give this, to make it clear to myself?--For I want to say: "and it stops being a game"--not: "and we now see that it wasn't a game".

Page 203

That means, I want to say, it can also be taken like this: the other man did not *draw our attention* to anything; he taught us a different game in place of our own.--But how can the new game have made the old one obsolete?--We now see something different, and can no longer naïvely go on playing.

On the one hand the game consisted in our actions (our play) on the board; and these actions I could perform as well now as before. But on the other hand it was essential to the game that I blindly tried to

Page Break 204

win; and now I can no longer do that.

Page 204

78. Let us suppose that people originally practised the four kinds of calculation in the usual way. Then they began to calculate with bracketed expressions, including ones of the form $(a - a)$. Then they noticed that multiplications, for example, were becoming ambiguous. Would this have to throw them into confusion? Would they have to say: "Now the solid ground of arithmetic seems to wobble"?

Page 204

And if they now demand a proof of consistency, because otherwise they would be in danger of falling into the bog at every step--what are they demanding? Well, they are demanding a kind of *order*. But was there *no* order before?--Well, they are asking for an order which appeases them now.--But are they like small children, that merely have to be lulled asleep?

Page 204

Well, multiplication would surely become unusable in practice because of its ambiguity--that is for the former normal purposes. Predictions based on multiplications would no longer hit the mark.--(If I tried to predict the length of the line of soldiers that can be formed from a square 50×50 , I should keep on arriving at wrong results.)

Is this kind of calculation wrong, then?--Well, it is unusable for *these* purposes. (Perhaps usable for other ones.) Isn't it as if I were once to divide instead of multiplying? (As can actually happen.)

Page Break 205

Page 205

What is meant by: "You have to *multiply* here; not divide!"--

Page 205

Now is ordinary multiplication a *proper* game; is it *impossible* to trip up? And is the calculation with $(a - a)$ not a proper game--is it impossible *not* to trip up?

Page 205

(What we want is to *describe*, not to explain.)

Page 205

Now, what is it for us not to know our way about in our calculus?

Page 205

We went sleepwalking along the road between abysses.--But even if we now say: "Now we are awake",--can we be certain that we shall not wake up one day? (And then say:--so we were asleep again.)

Page 205

Can we be certain that there are not abysses now that we do not see?

But suppose I were to say: The abysses in a calculus are not there if I don't see them!

Page 205

Is no demon deceiving us at present? Well, if he is, it doesn't matter. What the eye doesn't see the heart doesn't grieve over.

Page Break 206

Page 206

Suppose I were to divide by 3 sometimes like this:



sometimes like this



without noticing it.--Then someone draws my attention to it.

To a mistake? Is it necessarily a mistake? And in what circumstances do we call it one?

Page 206

$$\begin{array}{l}
 \sim f(f) = \phi(f) \text{ Def.} \\
 \vdots \\
 \phi(\phi) = \sim \phi(\phi)
 \end{array}
 \left. \vphantom{\begin{array}{l} \sim f(f) = \phi(f) \text{ Def.} \\ \vdots \\ \phi(\phi) = \sim \phi(\phi) \end{array}} \right\}$$

79.

Page 206

The propositions ' $\phi(\phi)$ ' and ' $\sim\phi(\phi)$ ' sometimes seem to say the same thing and sometimes opposite things. According as we look at it the proposition ' $\phi(\phi)$ ' sometimes seems to say $\sim\phi(\phi)$, sometimes the opposite. And we sometimes see it as the product of the substitution:

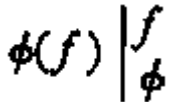

At other times as:

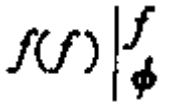

We should like to say: "Heterological' is not heterological; so by definition it can be called 'heterological'." And it sounds all right, goes quite smoothly, and the contradiction need not strike us at all. If we become aware of the contradiction, we should at first like to say that we do not mean the same thing by the assertion, ξ is heterological, in the two cases. The one time it is the unabbreviated assertion,

Page Break 207

the other time the assertion abbreviated according to the definition.

We should then like to get out of the thing by saying: ' $\sim\phi(\phi) = \phi_1(\phi)$ '. But why should we lie to ourselves like this? Here two *contrary* routes really do lead--to the *same* thing.

Or again:--*it is equally natural* in this case to say ' $\sim\phi(\phi)$ ' and ' $\phi(\phi)$ '.

According to the rule it is an equally natural expression to say that C lies to the right of the point A and that it lies to the left.

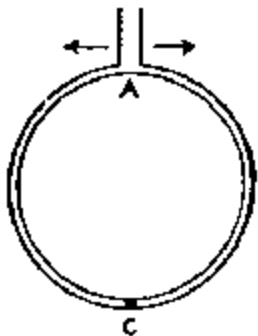

According to this rule--which says that a place lies in the direction of the arrow if the street that begins in that direction leads to it.

Page 207

Let us look at it from the point of view of the language-games.--

Originally we played the game only with straight streets.----

Page 207

80. Could it perhaps be imagined that where I see *blue*, this means that the object that I see is *not* blue--that the colour that appears to me always counts as the one that is *excluded*? I might for example believe that God always shews me a colour in order to say: *not* this.

Or does this work: the colour that I see merely tells me that this colour plays a part in the description of the object. It corresponds, not to a proposition, but merely to the word "blue". And the description

Page Break 208

of the object can then equally well run: "it is blue", and "it is not blue". Then one says: the eye only shows me blue, but not the role of this blue.--We compare seeing the colour with hearing the word "blue" when we have not heard the rest of the sentence.

Page 208

I should like to shew that we could be led to want to describe something's being blue, both by saying it was blue, and by saying it was not blue.

And so that it is in our hands to make such a shift in the method of projection that '*p*' and '*~p*' get the same sense. By which, however, they lose it, if I do not introduce something new as negation.

Page 208

Now a language-game can lose its sense through a contradiction, can lose the character of a language-game.

And here it is important to say that this character is not described by saying that the sounds must have a certain *effect*. For our language-game (2)†1 would lose the character of a language-game if the builders kept on uttering different sounds instead of the 4 orders; even if it could be shewn, say physiologically, that it was always these noises that moved the assistant to bring the stones that he did bring.

Page 208

Even here it could be said that of course the examination of language-games gets its importance from the fact that language-games continue to function. And so that it gets its importance from the fact that human beings can be trained to such a reaction to sounds.

Page Break 209

Page 209

It seems to me that there is a connexion between this and the question whether a calculation is an experiment made with a view to predicting the course of calculations. For suppose that one did a calculation and--correctly--predicted that one would calculate differently the next time, since the circumstances have changed then precisely by one's already having done the calculation *so-and-so* many times.

Calculating is a phenomenon which we know from calculating. As language is a phenomenon which we know from our language.

Page 209

Can we say: 'Contradiction is harmless if it can be sealed off'? But what prevents us from sealing it off? That we do not know our way about in the calculus. Then *that* is the harm. And this is what one means when one says: the contradiction indicates that there is something wrong about our calculus. It is merely the (local) *symptom* of a sickness of the whole body. But the body is only sick if we do not know our way about.

The calculus has a secret sickness, means: what we have got is, as it is, not a calculus, and *we do not know our way about*--i.e. cannot give a calculus which corresponds 'in essentials' to this simulacrum of a calculus, and only excludes what is wrong in it.

Page 209

But how is it possible not to know one's way about in a calculus: isn't it there, open to view?

Let us imagine having been taught Frege's calculus, contradiction and all. But the contradiction is not presented as a disease. It is, rather, an accepted part of the calculus, and we calculate with it. (The calculations

Page Break 210

do not serve the usual purpose of logical calculations.)--Now we are set the task of changing this calculus, of which the contradiction is an entirely respectable part, into another one, in which this contradiction is not to exist, as the new calculus is wanted for purposes which make a contradiction undesirable.--What sort of problem is this? And what sort of inability is it, if we say: "We have not yet found a calculus satisfying this condition"?

Page 210

When I say: "I don't know my way about in the calculus"--I do not mean a mental state, but an inability to *do* something.

Page 210

It is often useful, in order to help clarify a philosophical problem, to imagine the historical development, e.g. in mathematics, as quite different from what it actually was. If it had been different no one would have had the idea of saying what is actually said.

Page 210

I should like to ask something like: "Is it usefulness you are out for in your calculus?--In that case you do not get any contradiction. And if you aren't out for usefulness--then it doesn't matter if you do get one."

Page 210

81. Our task is, not to discover calculi, but to describe the *present* situation.

Page Break 211

Page 211

The idea of the predicate which is true of itself etc. does of course lean on *examples*--but these examples were *stupidities*, for they were not thought out at all. But that is not to say that such predicates could not be applied, and that the contradiction would not then have its application!

I mean: if one really fixes one's eye on the application, it does not occur to one at all to write ' $f(f)$ '. On the other hand, if one is using the signs in the calculus, *without presuppositions* so to speak, one may also write ' $f(f)$ ', and must then draw the consequences and not forget that one has not yet an *inkling* of a possible practical application of this calculus.

Page 211

Is the question this: "Where did we forsake the region of usability?"?--

Page 211

For might we not possibly have *wanted* to produce a contradiction? Have said--with pride in a mathematical discovery: "Look, this is how we produce a contradiction"? Might not e.g. a lot of people possibly have tried to produce a contradiction in the domain of logic, and then at last *one* person succeeded?

But why should people have tried to do *this*? Perhaps I cannot at present suggest the most plausible purpose. But why not e.g. in order to show that everything in this world is uncertain?

Page 211

These people would then never actually employ expressions of the form $f(f)$, but still would be glad to lead their lives in the *neighbourhood* of a contradiction.

Page Break 212

Page 212

"Can I see an *order* which prevents me from unwittingly arriving at a contradiction?" That is like saying: shew me an order in my calculus to convince me that I can never in this way arrive at a number which.... Then I shew him e.g. a recursive proof.

Page 212

But is it wrong to say: "Well, I shall go on. If I *see* a contradiction, then will be the time to do something about it."?--Is that: not really doing mathematics? Why should that *not* be calculating? I travel this road untroubled; if I should come to a precipice I shall try to turn round. Is that not 'travelling'?

Page 212

Let us imagine the following case: the people of a certain tribe only know oral calculation. They have no acquaintance with writing. They teach their children to count in the decimal system. Among them mistakes in counting are very frequent, digits get repeated or left out without their noticing. Now a traveller makes a gramophone record of their counting. He teaches them writing and written calculation, and then shews them how often they make mistakes when they calculate just by word of mouth.--Would these people now have to admit that they had not really calculated before? That they had merely been groping about, whereas now they walk? Might they not perhaps even say: our affairs went better before, our intuition was not burdened with the dead stuff of writing? You cannot lay hold of the spirit with a machine. They say perhaps: "If we repeated a digit then, as your machine asserts--well, that will have been right".

Page 212

We may trust 'mechanical' means of calculating or counting more than our memories. Why?--Need it be like this? I may have

Page Break 213

miscounted, but the machine, once constructed by us in such-and-such a way, cannot have miscounted. Must I adopt this point of view?--"Well, experience has taught us that calculating by machine is more trustworthy than by memory. It has taught us that our life goes smoother when we calculate with machines." But must smoothness

necessarily be our ideal (must it be our ideal to have everything wrapped in cellophane)?

Might I not even trust memory and not trust the machine? And might I not mistrust the *experience* which 'gives me the illusion' that the machine is more trustworthy?

Page 213

82. Earlier I was not certain that, among the kinds of multiplication corresponding to *this* description, there was none yielding a result different from the accepted one. But say my uncertainty is such as only to arise at a certain distance from calculation of the normal kind; and suppose that we said: there it does no harm; for if I calculate in a very abnormal way, then I must just reconsider everything. Wouldn't this be all right?

Page 213

I want to ask: *must* a proof of consistency (or of non-ambiguity) necessarily give me greater certainty than I have without it? And, if I am really out for adventures, *may* I not go out for ones where this proof no longer offers me any certainty?

Page 213

My aim is to alter the *attitude* to contradiction and to consistency proofs. (*Not* to shew that this proof shews something unimportant. How *could* that be so?)

Page Break 214

Page 214

If for example I were anxious to produce contradictions, say for aesthetic purposes, then I should now unhesitatingly accept the inductive proof of consistency and say: it is hopeless to try and produce a contradiction in this calculus; the proof shews that it won't work. (Proof in theory of harmony.)----

Page 214

83. It is a good way of putting things to say: "this order (this method) is unknown to this calculus, but not to that one".

What if one said: "A calculus to which this order is unknown is really not a calculus"?

(An office system to which this order is unknown is not really an office system.)

Page 214

It is--I should like to say--for practical, not for theoretical purposes, that the disorder is avoided.

Page 214

A kind of order is introduced because one has fared ill without it--or again, it is introduced, like streamlining in perambulators and lamps, because it has perhaps proved its value somewhere else and in this way has become the style or fashion.

Page 214

The misuse of the idea of *mechanical* insurance against contradiction. But what if the parts of the mechanism fuse together, break or bend?

Page Break 215

Page 215

84. "Only the proof of consistency shews me that I can rely on the calculus."

Page 215

What sort of proposition is it, that only *then* can you rely on the calculus? But what if you do rely on it *without* that proof! What sort of mistake have you made?

Page 215

I introduce order; I say: "There are only *these* possibilities: ...". It is like determining the set of possible permutations of *A, B, C*: before the order was there, I had perhaps only a foggy idea of this set.--Am I now quite certain that I have overlooked nothing? The order is a method for not overlooking anything. But--for not overlooking any possibility in the calculus, or: for not overlooking any possibility in reality?--Is it now certain that people will never want to calculate differently? That people will never look at our calculus as we look at the counting of aborigines whose numbers only go up to 5?--that we shall never want to look at reality differently? But *that* is not at all the certainty that this order is supposed to give us. It is not the eternal correctness of the calculus that is supposed to be assured, but only, so to speak, the temporal.

Page 215

'But these are the possibilities that you *mean!*--Or do you mean other ones?'

Page 215

The order convinces me that I have overlooked nothing when I have these 6 possibilities. But does it also convince me that nothing is going to be able to upset my present conception of such possibilities?

85. Could I imagine our fearing a possibility of constructing the heptagon, like the construction of a contradiction; and that the proof that the construction of the heptagon is impossible should have a settling effect, like a consistency proof?

How does it come about that we are at all tempted (or at any rate come near it) to divide through by $(3 - 3)$ in $(3 - 3) \times 2 = (3 - 3) \times 5$? How does it come about that by the rules this step looks plausible, and that even so it is still unusable?

When one tries to describe this situation it is enormously easy to make a mistake in the description. (So it is very difficult to describe.) The descriptions which immediately suggest themselves are all misleading--that is how our language in this field is arranged.

And there will be constant lapses from description into explanation here.

It was, or appears to be, *roughly* like this: we have a calculus, let us say, with the beads of an abacus; we then replace it by a calculus with written signs; this calculus suggests to us an extension of the method of calculating which the first calculus did not suggest--or perhaps better: the second calculus *obliterates* a distinction which was not to be overlooked in the first one. Now if it was the point of the first calculus that this distinction was made, and it is not made in the second one then the latter thereby lost its usability as an equivalent of the former. And now--it seems--the problem might arise: *where* did we depart from the original calculus, what frontiers in the new one correspond to the natural frontiers of the old?

I formed a system of rules of calculation which were modelled on those of another calculus. I took the latter as a model. But exceeded its limits. This was even an advantage; but now the new calculus became unusable in certain parts (at least for the former purposes). I therefore seek to alter it: that is, to replace it by one that is *to some extent* different. And by one that has the advantages without the disadvantages of the new one. But is that a clearly *defined* task?

Is there such a thing--it might also be asked--as *the right* logical calculus, only without the contradictions?

Could it be said, e.g., that while Russell's Theory of Types avoids the contradiction, still Russell's calculus is not THE universal logical calculus but perhaps an artificially restricted, mutilated one? Could it be said that the *pure, universal* logical calculus has yet to be found?

I was playing a game and in doing so I followed certain rules: but as for *how* I followed them, that depended on circumstances and the way it so depended was not laid down in black and white. (This is to some extent a misleading account.) Now I wanted to play this game in such a way as to follow rules 'mechanically' and I 'formalized' the game. But in doing this I reached positions where the game lost *all* point; I therefore wanted to avoid these positions 'mechanically'.--The formalization of logic did not work out satisfactorily. But what was the attempt made for at all? (What was it useful for?) Did not this need, and the idea that it must be capable of satisfaction, arise from a lack of clarity in another place?

The question "what was it useful for?" was a quite *essential* question. For the calculus was not invented for some practical purpose, but in order 'to give arithmetic a foundation'. But who says that arithmetic is logic, or what has to be done with logic to make it in some sense into a substructure for arithmetic? If we had e.g. been led to attempt this

by aesthetic considerations, who says that it can succeed? (Who says that this English poem can be translated into German to our satisfaction?!)

(Even *if* it is clear that there is in *some* sense a translation of any English sentence into German.)

Philosophical dissatisfaction disappears by our seeing *more*.

By my allowing the cancelling of $(3 - 3)$ this type of calculation loses its point. But suppose that, for example, I were to introduce a new sign of equality which was supposed to express: 'equal after *this* operation'? Would it, however, make sense to say: "Won in *this* sense", if in this sense I should win *every* game?

At certain places the calculus led me to its own abrogation. Now I want a calculus that does not do this and that excludes these places.--Does this mean, however, that any calculus in which such an exclusion does not occur is an uncertain one? "Well, the discovery of these places was a warning to us."--But did you not *misunderstand* this 'warning'?

Page 218

86. Can one prove that one has not overlooked anything?--Certainly. And must one not perhaps admit later: "Yes, I did overlook something; but not in the field for which my proof held"?

Page 218

The proof of consistency must give us reasons for a prediction; and

Page Break 219

that is its *practical purpose*. That does not mean that this proof is a proof from the physics of our technique of calculation--and so a proof from applied mathematics--but it does mean that that prediction is the application that first suggests itself to us, and the one for whose sake we have this proof at heart. The prediction is not: "No disorder will arise *in this way*" (for that would not be a prediction: it is the mathematical proposition) but: "no disorder will arise".

Page 219

I wanted to say: the consistency-proof can only set our minds at rest, if it is a cogent reason for this prediction.

Page 219

87. Where it is enough for me to get a proof that a contradiction or a trisection of the angle cannot be constructed in *this way*, the recursive proof achieves what is required of it. But if I had to fear that something somehow might at some time be interpreted as the construction of a contradiction, then no proof can take this indefinite fear from me.

Page 219

The fence that I put round contradiction is not a super-fence.
How can a proof have put the calculus right in principle?

Page 219

How can it have failed to be a proper calculus until this proof was found?

Page Break 220

Page 220

"This calculus is purely mechanical; a machine could carry it out." What sort of machine? One constructed of the usual materials--or a super-machine? Are you not confusing the hardness of a rule with the hardness of a material?

Page 220

We shall see contradiction in a quite different light if we look at its occurrence and its consequences as it were anthropologically--and when we look at it with a mathematician's exasperation. That is to say, we shall look at it differently, if we try merely to *describe* how the contradiction influences language-games, and if we look at it from the point of view of the mathematical law-giver.

Page 220

88. But wait--isn't it clear that no one wants to reach a contradiction? And so that if you shew someone the possibility of a contradiction, he will do everything to make such a thing impossible? (And so that if someone does not do this, he is a sleepyhead.)

Page 220

But suppose he replied: "I can't imagine a contradiction in my

Page Break 221

calculus.--You have indeed shewn me a contradiction in another, but not in *this* one. In this *there is none*, nor can I see the possibility of one."

Page 221

"If my conception of the calculus should sometime alter; if its aspect should alter because of some context that I cannot see now--then we'll talk some more about it."

"I do *not* see the possibility of a contradiction. Any more than you--as it seems--see the possibility of there being one in your consistency-proof."

Page 221

Do I know whether, if I ever should see a contradiction where at present I can see no possibility of such a

thing, it will then look dangerous to me?

Page 221

89. "What does a proof teach me, apart from its result?"--What does a new tune teach me? Am I not under a temptation to say it teaches me something?--

Page 221

90. I have not yet made the role of miscalculating clear. The role of the proposition: "I must have miscalculated". It is really the key to an understanding of the 'foundations' of mathematics.

Page Break 222

Page Break 223

PART IV 1942-1944

Page 223

1. "The axioms of a mathematical axiom-system ought to be self-evident." How are they self-evident, then? What if I were to say: *this* is how I find it easiest to imagine.

And here imagining is not a particular mental process during which one usually shuts one's eyes or covers them with one's hands.

Page 223

2. What do we say when we are presented with such an axiom, e.g. the parallel axiom? Has experience shewn us that this is how it is? Well perhaps; but *what* experience? I mean: experience plays a part; but not the one that one would *immediately expect*. For we haven't made experiments and found that in reality only *one* straight line through a given point fails to cut another. And yet the proposition is evident.--Suppose I now say: it is quite indifferent why it is evident. It is enough that we accept it. All that is important is how we use it.

Page 223

The proposition describes a picture. Namely:

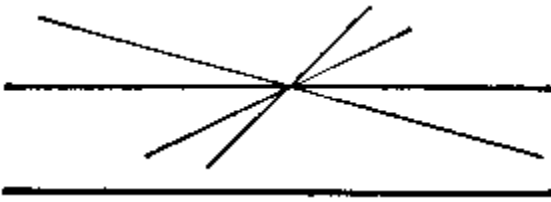

We find this picture acceptable. As we find it acceptable to indicate our rough knowledge of a number by rounding it off at a multiple of 10.

Page Break 224

Page 224

'We accept this proposition.' But as *what* do we accept it?

Page 224

3. I want to say: when the words of e.g. the parallel-axiom are given (and we understand the language) the kind of use this proposition has and hence its sense are as yet quite undetermined. And when we say that it is evident, this means that we have already chosen a definite kind of employment for the proposition without realizing it. The proposition is not a mathematical axiom if we do not employ it precisely *for this purpose*.

Page 224

The fact, that is, that here we do not make experiments, but accept the self-evidence, is enough to fix the employment. For we are not so naïf as to make the self-evidence count in place of experiment.

Page 224

It is not our finding the proposition self-evidently true, but our making the self-evidence count, that makes it into a mathematical proposition.

Page 224

4. Does experience tell us that a straight line is possible between any two points? Or that two different colours cannot be at the same place?

It might be said: *imagination* tells us it. And the germ of truth is here; only one must understand it right.

Page 224

Before the proposition the concept is still pliable.

Page Break 225

Page 225

But might not experience determine us to reject the axiom?! Yes. And nevertheless it does not play the part of an empirical proposition.

Page 225

Why are the Newtonian laws not axioms of mathematics? Because we could quite well imagine things being otherwise. But--I want to say--this only assigns a certain role to those propositions in contrast to another one. I.e.: to say of a proposition: 'This could be imagined otherwise' or 'We can imagine the opposite too', ascribes the role of an empirical proposition to it.

Page 225

A proposition which it is supposed to be impossible to imagine as other than true has a different *function* from one for which this does not hold.

Page 225

5. The functioning of the axioms of mathematics is such that, if experience moved us to give up an axiom, that would not make its opposite into an axiom.

' $2 \times 2 \neq 5$ ' does not mean:

' $2 \times 2 = 5$ ' has not worked.

Page 225

One might, so to speak, preface axioms with a special assertion sign.

Page 225

Something is an axiom, *not* because we accept it as extremely probable, nay certain, but because we assign it a particular function, and

Page Break 226

one that conflicts with that of an empirical proposition.

Page 226

We give an axiom a different kind of acknowledgment from an empirical proposition. And by this I do not mean that the 'mental act of acknowledgment' is a different one.

Page 226

An axiom, I should like to say, is a different part of speech.

Page 226

6. When one hears the mathematical axiom that such and such is possible, one assumes offhand that one knows what 'being possible' means here; because this form of sentence is naturally familiar to us.

Page 226

We are not made aware how various the employment of the assertion "... is possible" is! And that is why it does not occur to us to ask about the special employment in this case.

Page 226

Lacking the slightest survey of the whole use, we are here quite unable to doubt that we understand the proposition.

Page 226

Does the proposition that there is no such thing as action at a distance belong to the family of mathematical propositions? Here again one would like to say: the proposition is not designed to express any experience, but rather to express the impossibility of imagining anything different.

Page Break 227

Page 227

To say that between two points a straight line is--geometrically--always possible means: the proposition "The points... lie on a straight line" is an assertion about the position of the points only if more than 2 points are involved.

Page 227

Just as one does not ask oneself, either, what is the meaning of a proposition of the form "There is no..." (e.g. "there is no proof of this proposition") in a particular case. Asked what it means, one replies both to someone else and to oneself with an example of nonexistence.

Page 227

7. A mathematical proposition stands on four feet, not on three; it is over-determined.

Page 227

8. When we describe what a man does, e.g., by means of a rule, we want the person to whom we give the description to know, by applying the rule, what happens in the particular case. Now do I give him an *indirect* description by means of the rule?

Page 227

There is of course such a thing as a proposition saying: if anyone tries to multiply the numbers... according to such and such rules, he gets....

Page 227

One application of a mathematical proposition must always be the calculating itself. That determines the relation of the activity of calculating to the sense of mathematical propositions.

Page Break 228

Page 228

We judge identity and agreement by the results of our calculating; that is why we cannot use agreement to explain calculating.

Page 228

We describe by means of the rule. What for? Why? That is another question.

Page 228

'The rule, applied to these numbers, yields those' might mean: the expression of the rule, applied to a human being, makes him produce those numbers from these.

Page 228

One feels, quite rightly, that that would *not* be a mathematical proposition.

Page 228

The mathematical proposition determines a path, lays down a path for us.

Page 228

It is no contradiction of this that it is a rule, and not simply stipulated but produced according to rules.

Page 228

If you use a rule to give a description, you yourself do not know more than you say. I.e. you yourself do not foresee the application that you will make of the rule in a particular case. If you say "and so on", you yourself do not know more than "and so on".

Page Break 229

Page 229

9. How could one explain to anybody what you have to do if you are to follow a rule?

Page 229

One is tempted to explain: first and foremost do the *simplest* thing (if the rule e.g. is always to repeat the same thing). And there is of course something in this. It is significant that we can say that it is simpler to write down a sequence of numbers in which each number is the same as its predecessor than a sequence in which each number is greater by 1 than its predecessor. And again that this is a simpler law than that of alternately adding 1 and 2.

Page 229

10. Isn't it over-hasty to apply a proposition that one has tested on sticks and stones, to wavelengths of light? I mean: that $2 \times 5000 = 10,000$.

Does one actually count on it that what has proved true in so many cases must hold for these too? Or is it not rather that with the arithmetical assumption we have not committed ourselves *at all*?

Page 229

11. Arithmetic as the natural history (mineralogy) of numbers. But *who* talks like this about it? Our whole thinking is penetrated with this idea.

Page 229

The numbers (I don't mean the numerals) are shapes, and arithmetic tells us the properties of these shapes. But the difficulty here is that these properties of the shapes are *possibilities*, not the properties in respect to shape of the things of this shape. And these possibilities in turn emerge as physical, or psychological possibilities (of separation, arrangement, etc.). But the role of the shapes is merely that of pictures

Page Break 230

which are used in such-and-such a way. What we give is not properties of shapes, but transformations of shapes, set up as paradigms of some kind or other.

Page 230

12. We do not judge the pictures, we judge by means of the pictures.

We do not investigate them, we use them to investigate something else.

Page 230

You get him to decide on accepting this picture. And you do so by means of the proof, i.e. by exhibiting a series of pictures, or simply by shewing him the picture. What moves him to decide does not matter here. The main

thing is that it is a question of accepting a picture.

Page 230

The picture of combining is not a combining; the picture of separating is not a separating; the picture of something's fitting not a case of fitting. And yet these pictures are of the greatest significance. *That is what it is like*, if a combination is made; if a separation; and so on.

Page 230

13. What would it be for animals or crystals to have as beautiful properties as numbers? There would then be e.g. a series of forms, each bigger than another by a unit.

Page 230

I should like to be able to describe how it comes about that mathematics appears to us now as the natural history of the domain of numbers, now again as a collection of rules.

Page Break 231

Page 231

But could one not study transformations of (e.g.) the forms of animals? But *how* 'study'? I mean: might it not be useful to pass transformations of animal shapes in review? And yet this would not be a branch of zoology.

Page 231

It would then be a mathematical proposition (e.g.), that this shape is derived from *this* one by way of *this* transformation. (The shapes and transformations being recognizable.)

Page 231

14. We must remember, however, that by its transformations a mathematical proof proves not only propositions of sign-geometry, but propositions of the most various *content*.

In this way the transformation in a Russellian proof proves that this logical proposition can be formed from the fundamental laws by the use of these rules. But the proof is looked at as a proof of the truth of the conclusion, or as a proof that the conclusion says *nothing*.

Now this is possible only through a relation of the proposition to something outside itself; I mean, e.g., through its relation to other propositions and to their application.

Page 231

"A tautology (e.g. ' $p \vee \sim p$ ') says nothing" is a proposition referring to the language-game in which the proposition p has application. (E.g. "It is raining or it is not raining" tells us nothing about the weather.)

Page 231

Russellian logic says nothing about kinds of *propositions*--I don't mean *logical* propositions--and their employment: and yet logic gets its whole sense simply from its presumed application to propositions.

Page Break 232

Page 232

15. People can be imagined to have an applied mathematics without any pure mathematics. They can e.g.--let us suppose--calculate the path described by certain moving bodies and predict their place at a given time. For this purpose they make use of a system of co-ordinates, of the equations of curves (*a form of description of actual movement*) and of the technique of calculating in the decimal system. The idea of a proposition of pure mathematics may be quite foreign to them.

Thus these people have rules in accordance with which they transform the appropriate signs (in particular, e.g., numerals) with a view to predicting the occurrence of certain events.

Page 232

But when they now multiply, for example, will they not arrive at a proposition saying that the result of the multiplication is the same, however the factors are shifted round? That will not be a primary rule of notation, nor yet a proposition of their physics.

They do not *need* to obtain any such proposition--even if they allow the shift of factors.

Page 232

I am imagining the matter as if this mathematics were done entirely in the form of orders. "You must do *such-and-such*"--so as to get the answer, that is, to the question 'where will this body be at such-and-such a time?' (It does not matter at all how these people have arrived at this method of prediction.)

Page 232

The centre of gravity of their mathematics lies for these people *entirely* in *doing*.

Page Break 233

Page 233

16. But is this possible? Is it possible that they should not pronounce the commutative law (e.g.) to be a *proposition*?

Page 233

But I want to say: these people are not supposed to arrive at the conception of making mathematical discoveries--but *only* of making physical discoveries.

Page 233

Question: Must they make mathematical discoveries as discoveries? What do they miss if they make none? Could they (for example) use the proof of the commutative law, but without the conception of its culminating in a *proposition*, and so having a result which is in some way comparable with their physical propositions?

Page 233

17. The mere picture

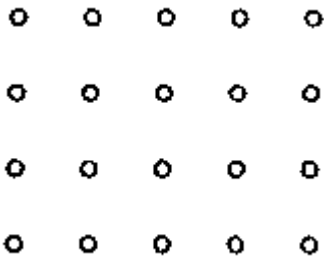

regarded now as four rows of five dots, now as five columns of four dots, might convince someone of the commutative law. And he might thereupon carry out multiplications, now in the one direction, now in the other.

Page 233

One look at the pattern and pieces convinces him that he will be able to make them into that shape, i.e. he thereupon *undertakes* to do so.

Page Break 234

Page 234

"Yes, but only if the pieces don't change."--If they don't change, and we don't make some unintelligible mistake, or pieces disappear or get added without our noticing it.

"But it is surely essential that the pieces can as a matter of fact always be made into that shape! What would happen if they could not?"--Perhaps we should think that something had put us out. But--what then?--Perhaps we should even accept the thing as it was. And then Frege might say: "Here we have a new kind of insanity!"†1

Page 234

18. It is clear that mathematics as a technique for transforming signs for the purpose of prediction has nothing to do with grammar.

Page 234

19. The people whose mathematics was only such a technique, are now also supposed to accept proofs convincing them of the replaceability of one sign-technique by another. That is to say, they find transformations, series of pictures, on the strength of which they can venture to use one technique in place of another.

Page 234

20. If calculating looks to us like the action of a machine, it is *the human being* doing the calculation that is the machine.

Page 234

In that case the calculation would be as it were a diagram drawn by a part of the machine.

Page Break 235

Page 235

21. And that brings me to the fact that a picture may very well convince us that a particular part of a mechanism will move in such-and-such a way when the mechanism is set in motion.

Page 235

The effect of such a picture (or series of pictures) is like that of a proof. In this way I might e.g. make a construction for how the point X of the mechanism



will move.

Page 235
Is it not *queer* that it is not instantly clear *how* the picture of the period in division convinces us of the recurrence of that row of digits?

Page 235
(I find it so difficult to separate the inner from the outer--and the picture from the prediction.)

Page 235
The twofold character of the mathematical proposition--as *law* and as *rule*.

Page 235
22. Suppose that one were to say "guessing right" instead of "intuition"? This would shew the value of an intuition in a quite

Page Break 236
different light. For the phenomenon of guessing is a psychological one, but not that of guessing right.

Page 236
23. Our having learned a technique brings it about that we now alter it in such and such a way after seeing this picture.

Page 236
'We decide on a new language-game.'
'We decide *spontaneously*' (I should like to say) 'on a new language-game.'

Page 236
24. True;--it looks as though, if our memory functioned differently, we could not calculate as we do. But in that case could we give definitions as we do; talk and write as we do?

But how can we describe the foundation of our language by means of empirical propositions?

Page 236
25. Suppose that when we worked out a division it did not lead to the same result as the copying of its period. That might arise e.g. from our altering our tables, without being aware of it. (Though it might also arise from our copying in a different way.)

Page 236
26. What is the difference between *not* calculating and calculating *wrong*?--Or: is there a sharp dividing line between *not* measuring time and measuring it *wrong*? Not knowing any measurement of time and knowing a wrong one?

Page Break 237

Page 237
27. Pay attention to the patter by means of which we convince someone of the truth of a mathematical proposition. It tells us something about the function of this conviction. I mean the patter by which intuition is awakened.

By which, that is, the machine of a calculating technique is set in motion.

Page 237
28. Can it be said that if you learn a technique, that convinces you of the uniformity of its results?

Page 237
29. The limit of the empirical†1--is *concept-formation*.

Page 237
What is the transition that I make from "It will be like this" to "it *must* be like this"? I form a different concept. One involving something that was not there before. When I say: "If these derivations are the same, then it *must* be that...", I am making something into a criterion of identity. So I am recasting my concept of identity.

Page 237
But what if someone now says: "I am not aware of these *two* processes, I am only aware of the empirical, not of a formation and transformation of concepts which is independent of it; everything seems to me to be in the service of the empirical"?

In other words: we do not seem to become now more, now less, rational, or to alter the form of our thinking,

so as to alter *what we call "thinking"*. We only seem always to be fitting our thinking to experience.

Page Break 238

Page 238

So much is clear: when someone says: "If you follow the *rule*, it *must* be like this", he has not any *clear* concept of what experience would correspond to the opposite.

Page 238

Or again: he has not any clear concept of what it would be like for it to be otherwise. And this is very important.

Page 238

30. What compels us *so* to form the concept of identity as to say, e.g., "If you really do the same thing both times, then the result must be the same too"?--What compels us to proceed according to a rule, to conceive something as a rule? What compels us to talk to ourselves in the forms of the languages we have learnt?

Page 238

For the word "must" surely expresses our inability to depart from *this* concept. (Or ought I to say "refusal"?)

Page 238

And even if I have made the transition from one concept-formation to another, the old concept is still there in the background.

Page 238

Can I say: "A proof induces us to make a certain decision, namely that of accepting a particular concept-formation"?

Page 238

Do not look at the proof as a procedure that *compels* you, but as one

Page Break 239

that *guides* you.--And what it guides is your *conception* of a (particular) situation.

Page 239

But how does it come about that it guides *each one* of us in such a way that we agree in the influence it has on us? Well, how does it come about that we agree in *counting*? "That is just how we are trained" one may say, "and the agreement produced in this way is carried further by the proofs."

Page 239

In the course of this proof we formed our way of looking at the trisection of the angle, which excludes a construction with ruler and compass.

Page 239

By accepting a proposition as self evident, we also release it from all responsibility in face of experience.

Page 239

In the course of the proof our way of seeing is changed--and it does not detract from this that it is connected with experience.

Page 239

Our way of seeing is remodelled.

Page 239

31. It must be like this, does not mean: it will be like this. On the contrary: 'it will be like this' chooses between one possibility and another. 'It must be like this' sees only *one* possibility.

Page Break 240

Page 240

The proof as it were guides our experience into definite channels. Someone who has tried again and again to do such-and-such gives the attempt up after the proof.

Page 240

Someone tries to arrange pieces to make a particular pattern. Now he sees a model in which one *part* of that pattern is seen to be composed of all his pieces, and he gives up his attempt. The model was the *proof* that his proposal is impossible.

Page 240

That model too, like the one that shews that he will be able to make a pattern of these pieces, changes his *concept*. For, one might say, he never looked at the task of making the pattern of these pieces in this way before.

Page 240

Is it obvious that if anyone sees that part of the pattern can be made with these pieces, he realizes that there is no way of making the whole pattern with them? May it not be that he goes on trying and trying whether after all some arrangement of the pieces does not achieve this end? And may he not achieve it? (Use of one piece twice over, e.g.)

Page 240

Must we not distinguish here between thinking and the practical success of the thinking?

Page 240

32. "... who do not have immediate knowledge of certain truths, as we do, but perhaps are reduced to the roundabout path of

Page Break 241

induction", says Frege.†1 But what interests me is this immediate insight, whether it is of a truth or of a falsehood. I am asking: what is the characteristic demeanour of human beings who 'have insight into' something 'immediately', whatever the practical result of this insight is?

Page 241

What interests me is not having immediate insight into a truth, but the phenomenon of immediate insight. Not indeed as a special mental phenomenon, but as one of human action.

Page 241

33. Yes: it is as if the formation of a concept guided our experience into particular channels, so that one experience is now seen together with another one in a new way. (As an optical instrument makes light come from various sources in a particular way to form a pattern.)

Page 241

Imagine that a proof was a work of fiction, a stage play. Cannot watching a play lead me to something?

Page 241

I did not know how it would go,--but I saw a picture and became convinced that it would go as it does in the picture.

The picture helped me to make a prediction. Not as an experiment--it was only midwife to the prediction.

Page Break 242

Page 242

For, whatever my experience is or has been, I surely still have to *make* the prediction. (Experience does not make it for me.)

Page 242

No great wonder, then, that proof helps us to *predict*. Without this picture I should not have been able to say how it will be, but when I see it I seize on it with a view to prediction.

Page 242

I cannot predict the colour of a chemical compound by means of a picture exhibiting the substances in the test-tube and the reaction. If the picture shewed frothing, and finally red crystals, I should not be able to say: "Yes, *that* is how it has to be" or "No, it cannot be like that". It is otherwise, however, when I see the picture of a mechanism in motion; that can tell me how a part actually will move. Though if the picture represented a mechanism whose parts were composed of a very soft material (dough, say), and hence bent about in various ways in the picture, then this picture might not help me to make a prediction either.

Page 242

Can we say that a concept is so formed as to be adapted to a certain prediction, i.e. it enables it to be made in the simplest terms--?

Page 242

34. The philosophical problem is: how can we tell the truth and *pacify* these strong prejudices in doing so?

Page Break 243

Page 243

It makes a difference whether I think of something as a deception of my senses or an external event, whether I take this object as a measure of that or the other way round, whether I resolve to make two criteria decide or only one.

Page 243

35. If the calculation has been done right, then this must be the result. Must *this always* be the result, in that case? Of course.

By being educated in a technique, we are also educated to have a way of looking at the matter which is just as firmly rooted as that technique.

Mathematical propositions seem to treat neither of signs nor of human beings, and therefore they *do* not.

They shew *those* connexions that we regard as rigid. But to a certain extent we look away from these connexions and at something else. We turn our back upon them, so to speak. Or: we rest, or lean, on them.

Once more: we do not look at the mathematical proposition as a proposition dealing with signs, and hence it *is* not that.

We acknowledge it *by* turning our back on it.

What about e.g. the fundamental laws of mechanics? If you understand them you must know how experience supports them. It is otherwise with the propositions of pure mathematics.

36. A proposition may describe a picture and this picture be variously anchored in our way of looking at things, and so in our way of living and acting.

Is not the proof too flimsy a reason for entirely giving up the search for a construction of the trisection? You have only gone through the sequence of signs once or twice; will you decide on the strength of that? Just because you have seen this one transformation, will you give up the search?

The effect of proof is, I believe, that we plunge into the new rule.

Hitherto we have calculated according to such and such a rule; now someone shews us the proof that it can also be done in another way, and we switch to the other technique--not because we tell ourselves that it will work this way too, but because we feel the new technique as identical with the old one, because we have to give it the same sense, because we recognize it as the same just as we recognize this colour as green.

That is to say: insight into mathematical relations has a role similar to that of seeing an identity. It might almost be said to be a more complicated kind of identity.

It might be said: the reasons why we now shift to a different technique are of the same kind as those which make us carry out a new multiplication as we do; we accept the technique as the *same* as we have applied in doing other multiplications.

37. A human being is *imprisoned* in a room, if the door is unlocked but opens inwards; he, however, never gets the idea of *pulling* instead of pushing against it.

38. When white turns black some people say "Essentially it is still the same"; and others, when the colour turns a shade darker: "It is *completely* different".

39. The proposition ' $a = a$ ', ' $p \supset p$ ', "The word 'Bismarck' has 8 letters", "There is no such thing as reddish-green", are all obvious and are propositions about essence: what have they in common? They are evidently each of a different kind and differently used. The last but one is the most like an empirical proposition. And it can understandably be called a synthetic *a priori* proposition.

It can be said: unless you put the series of numbers and the series of letters side by side, you cannot know how many letters the word has.

40. One pattern derived from another according to a rule. (Say the reversal of a theme.)

Then the result put as equivalent to the operation.

41. When I wrote "proof must be perspicuous" that meant: *causality* plays no part in the proof.

Or again: a proof must be capable of being reproduced by mere copying.

42. That, if you go on dividing $1 : 3$, you must keep on getting 3 in the result is not known by intuition, any more than that the multiplication 25×25 yields the same product every time it is repeated.

43. It might perhaps be said that the synthetic character of the propositions of mathematics appears most obviously in the unpredictable occurrence of the prime numbers.

But their being synthetic (in this sense) does not make them any the less *a priori*. They could be said, I want to say, not to be got out of their concepts by means of some kind of analysis, but really to determine a concept by synthesis, e.g. as crossing prisms can be made to determine a body.

The distribution of primes would be an ideal example of what could be called synthetic *a priori*, for one can say that it is at any rate not discoverable by an analysis of the concept of a prime number.

44. Might one not really talk of intuition in mathematics? Though it would not be a *mathematical* truth that was grasped intuitively, but a physical or psychological one. In this way I know with *great* certainty that if I multiply 25 by 25 ten times I shall get 625 every time. That is to say I know the psychological fact that this calculation will keep on seeming correct to me; as I know that if I write down the series of numbers from 1 to 20 ten times my lists will prove identical on collation.--Now is that an empirical fact? Of course--and yet it would be difficult to mention experiments that would convince me of it. Such a thing might be called an intuitively known *empirical* fact.

45. You want to say that every new proof alters the concept of proof in one way or another.

But then by what principle is something recognized as a new proof? Or rather there is certainly no 'principle' here.

46. Now ought I to say: "we are convinced that the same result will always come out"? No, that is not enough. We are convinced that the same *calculation* will always come out, be calculated. Now is *that* a mathematical conviction? No--for if it were not always the same that was calculated, we could not conclude that the calculation yields at one time one result and at another time another.

We are *of course* also convinced that when we repeat a calculation we shall repeat the pattern of the calculation.--

47. Might I not say: if you do a multiplication, in any case you do not find the mathematical fact, but you do find the mathematical proposition? For what you *find* is the non-mathematical fact, and in this way the mathematical proposition. For a mathematical proposition is the determination of a concept following upon a discovery.



Page 248

You *find* a new physiognomy. Now you can e.g. memorize or copy it.

Page 248

A *new* form has been found, constructed. But it is used to give a new concept together with the old one.

Page 248

The concept is altered so that this *had* to be the result.

Page 248

I find, not the result, but that I reach it.

Page Break 249

Page 249

And it is not this route's beginning here and ending here that is an empirical fact, but my having gone this road, or some road to this end.

Page 249

48. But might it not be said that the *rules* lead this way, even if no one went it?

Page 249

For that is what one would like to say--and here we see the mathematical machine, which, driven by the rules themselves, obeys only mathematical laws and not physical ones.

Page 249

I want to say: the working of the mathematical machine is only the *picture* of the working of a machine.

Page 249

The rule does not do work, for whatever happens according to the rule is an interpretation of the rule.

Page 249

49. Let us suppose that I have the stages of the movement of

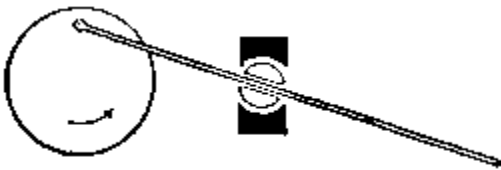

in a picture in front of me; then this enables me to form a proposition, which I as it were read off from this picture. The proposition contains the word "roughly" and is a proposition of geometry.

Page Break 250

Page 250

It is queer that I should be able to read off a proposition from a *picture*.

Page 250

The proposition, however, does not treat of the picture that I see. It does not say that such-and-such can be seen in this picture. But nor does it say what the actual mechanism will do, although it suggests it.

Page 250

But could I draw the movement of the mechanism in other ways too, if its parts do not alter? That is to say, am I not *compelled, under these conditions*, to accept just this as the picture of the movement?

Page 250

Let us imagine the construction of the phases of the mechanism carried out with lines of changing colour. Let the lines be partly black on a white ground, partly white on a black ground. Imagine the constructions in Euclid carried out in this way; they will lose all obviousness.

Page 250

50. A word in reverse has a *new* face.

Page 250

What if it were said: If you reverse the sequence 1 2 3, you *learn* about it that it yields 3 2 1 when reversed? And what you learn is not a property of these ink-marks, but of the sequence of *forms*. You learn a *formal* property of forms. The proposition asserting this formal property is proved by experience, which shews you the one form arising in this way out of the other.

Page Break 251

Page 251

Now, if you learn this, do you have *two* impressions? One of the fact that the sequence is *reversed*, the other of the fact that 3 2 1 arises? And could you not have the experience, the impression, of 1 2 3's being reversed and yet not of 3 2 1's arising? Perhaps it will be said: "Only by a queer illusion".--

Page 251

The reason why one really cannot say that one learns that formal proposition from experience is--that one only calls it this experience when this process leads to this result. The experience meant consists as such of this process with this result.

Page 251

That is why it is more than the experience: seeing a pattern.

Page 251

Can one row of letters have two reverses?

Say one acoustic, and another, optical, reverse. Suppose I explain to someone what the reverse of a word on paper is, what we call that. And now it turns out that he has an acoustic reverse of the word, i.e., something that he would like to call that, but it does not quite agree with the written reverse. So that one can say: he hears *this* as the reverse of the word. As if, as it were, the word got distorted for him in being turned round. And this might perhaps occur if he pronounced the word and its reverse fluently, as opposed to the case of spelling it out. Or the reverse might seem different when he spoke the word forwards and backwards in a single utterance.

Page 251

It might be that the exact mirror-image of a profile, seen immediately

Page Break 252

after it, was never pronounced to be the same thing, merely turned in the other direction; but that in order to give the impression of exact reversal, the profile had to be altered a little in its measurements.

Page 252

But I want to say that we have no right to say: though we may indeed be in doubt about the correct reverse of, for example, a long word, still we *know* that the word has only *one* reverse.

Page 252

"Yes, but if it is supposed to be a reverse in *this* sense there can be only one." Does 'in this sense' here mean: by these rules, or: with this physiognomy? In the first case the proposition would be tautological, in the second it need not be true.

Page 252

51. Think of a machine which 'is so constructed' that it reverses a row of letters. And now of the proposition that in the case of

O V E R

the result is

R E V O.--

Page 252

The rule, as it is actually meant, seems to be a driving power which reverses an ideal sequence like *this*,--whatever a human being may do with an actual sequence.

This is the mechanism which is the yardstick, the ideal, for the actual mechanism.

Page Break 253

Page 253

And that is *intelligible*. For if the result of the reversal becomes the criterion for the row's really having been reversed, and if we express this as our imitating an ideal machine, then this machine must produce this result *infallibly*.

Page 253

52. Now can it be said that the concepts which mathematics produces are a convenience, that essentially we could do without them?

Page 253

First and foremost the adoption of these concepts expresses the *sure* expectation of certain experiences.

Page 253

We do not accept e.g. a multiplication's not yielding the same result every time.

Page 253

And what we expect with certainty is essential to our whole life.

Page 253

53. Why, then, should I not say that mathematical propositions just express those special expectations, i.e., therefore, that they express matters of experience? Only because they just do not. Perhaps I should not take the measure of adopting a certain concept if I did not quite definitely expect the occurrence of certain facts; but for that reason laying down this measure and expressing the expectations are not equivalent.

Page Break 254

Page 254

54. It is difficult to put the body of fact right side up: to regard the given as given. It is difficult to place the body differently from the way one is accustomed to see it. A table in a lumber room may always lie upside down, in order to save space perhaps. Thus I have always seen the body of fact placed like *this*, for reasons of various kinds; and now I am supposed to see something else as its beginning and something else as its end. That is difficult. It as it were will not stand like that, unless one supports it in this position by means of other contrivances.

Page 254

55. It is one thing to use a mathematical technique consisting in the avoidance of contradiction, and another to philosophize against contradiction in mathematics.

Page 254

56. Contradiction. Why just this *one* boggy? That is surely very suspicious.

Page 254

Why should not a calculation made for a practical purpose, with a contradictory result, tell me: "Do as you please, I, the calculation, do not decide the matter"?

Page 254

The contradiction might be conceived as a hint from the gods that I am to act and *not* consider.

Page 254

57. "Why should contradiction be disallowed in mathematics?" Well, why is it not allowed in our simple language-games? (There is

Page Break 255

certainly a connexion here.) Is this then a fundamental law governing all thinkable language-games?

Page 255

Let us suppose that a contradiction in an order, e.g. produces astonishment and indecision--and now we say: that is just the purpose of contradiction in this language-game.

Page 255

58. Someone comes to people and says: "I always lie". They answer: "Well, in that case we can trust you!"--But could *he* mean what he said? Is there not a feeling of being incapable of saying something really true; let it be what it may?--

Page 255

"I always lie!"--Well, and what about *that*?--"It was a lie too!"--But in that case you don't always lie!--"No, it's all lies!"

Perhaps we should say of this man that he doesn't mean the same thing as we do by "true" and by "lying". He means perhaps something like: What he says flickers; or nothing really comes from his heart.

Page 255

It might also be said: his "I always lie" was not really an *assertion*. It was rather an exclamation.

Page 255

And so it can be said: "If he was saying that sentence, not thoughtlessly--then he must have meant the words in such-and-such a way, he *cannot* have meant them in the usual way"?

Page Break 256

Page 256

59. Why should Russell's contradiction not be conceived as something supra-propositional, something that towers above the propositions and looks in both directions like a Janus head? N.B. the proposition $F(F)$ --in which $F(\xi) = \sim\xi(\xi)$ --contains no variables and so might hold as something supra-logical, as something unassailable, whose negation itself in turn only *asserts* it. Might one not even begin logic with this contradiction? And as it were descend from it to propositions.

Page 256

The proposition that contradicts itself would stand like a monument (with a Janus head) over the propositions of logic.

Page 256

60. The pernicious thing is not: to produce a contradiction in the region in which neither the consistent nor the contradictory proposition has any kind of work to accomplish; no, what *is* pernicious is: not to know how one reached the place where contradiction no longer does any harm.

Page Break 257

PART V 1942-1944

Page 257

1. It is of course clear that the mathematician, in so far as he really is 'playing a game' *does not infer*. For here 'playing' must mean: *acting* in accordance with certain rules. And it would already be something outside the mere game for him to infer that he could act in this way according to the general rule.

Page 257

2. Does a calculating machine *calculate*?

Page 257

Imagine that a calculating machine had come into existence by accident; now someone accidentally presses its knobs (or an animal walks over it) and it calculates the product 25×20 .

Page 257

I want to say: it is essential to mathematics that its signs are also employed in *mufti*.

It is the use outside mathematics, and so the *meaning* of the signs, that makes the sign-game into mathematics.

Page 257

Just as it is not logical inference either, for me to make a change from one formation to another (say from one arrangement of chairs to another) if these arrangements have not a linguistic function apart from this transformation.

Page 257

3. But is it not true that someone with no idea of the meaning

Page Break 258

of Russell's symbols could *work over* Russell's proofs? And so could in an important sense test whether they were right or wrong?

Page 258

A human calculating machine might be trained so that when the rules of inference were shewn it and perhaps exemplified, it read through the proofs of a mathematical system (say that of Russell), and nodded its head after every correctly drawn conclusion, but shook its head at a mistake and stopped calculating. One could imagine this creature as otherwise perfectly imbecile.

Page 258

We call a proof something that can be worked over, but can also be copied.

Page 258

4. If mathematics is a game, then playing some game is doing mathematics, and in that case why isn't dancing mathematics too?

Page 258

Imagine that calculating machines occurred in nature, but that people could not pierce their cases. And now suppose that these people use these appliances, say as we use calculation, though of that they know nothing. Thus e.g. they make predictions with the aid of calculating machines, but for them manipulating these queer objects is experimenting.

Page 258

These people lack concepts which we have; but what takes their place?

Think of the mechanism whose movement we saw as a geometrical (kinematic) proof clearly it would not normally be said of someone turning the wheel that he was proving something. Isn't it the same with someone who makes and changes arrangements of signs as a game; even when what he produces could be seen as a proof?

To say mathematics is a game is supposed to mean: in proving, we need never appeal to the meaning of the signs, that is to their extra-mathematical application. But then what does appealing to this mean at all? How can such an appeal be of any avail?

Does it mean passing out of mathematics and returning to it again, or does it mean passing from *one* method of mathematical inference to another?

What does it mean to obtain a new concept of the surface of a sphere? How is it then a concept of the surface of a *sphere*? Only in so far as it can be applied to real spheres.

How far does one need to have a concept of 'proposition', in order to understand Russellian mathematical logic?

5. If the intended application of mathematics is essential, how about parts of mathematics whose application--or at least *what*

mathematicians take for their application--is quite fantastic? So that, as in set theory, one is doing a branch of mathematics of whose application one forms an entirely false idea. Now, isn't one doing mathematics *none the less*?

If the operations of arithmetic only served to construct a cipher, its application would of course be fundamentally different from that of our arithmetic. But would these operations then be mathematical operations at all?

Can someone who is applying a decoding rule be said to be performing mathematical operations? And yet his transformations can be so conceived. For he could surely say that he was calculating what had to come out in decoding the symbols... with such-and-such a key. And the proposition: the signs..., decoded according to this rule, yield... is a mathematical one. As is the proposition that you can get to this position from *that* one in chess.

Imagine the geometry of four-dimensional space done with a view to learning about the living conditions of spirits. Does that mean that it is not mathematics? And can I now say that it determines concepts?

Would it not sound queer to say that a child could already do thousands and thousands of multiplications--by which is supposed to be meant that it can already calculate in the unlimited number domain. And indeed this might be reckoned an extremely modest way of putting it, as it says only 'thousands and thousands' instead of 'infinitely many'.

Could people be imagined, who in their ordinary lives only calculated up to 1000 and kept calculations with higher numbers for mathematical investigations about the world of spirits?

"Whether or not this holds of the surface of a *real* sphere--it does hold for the mathematical one"--this makes it look as if the special difference between the mathematical and an empirical proposition was that, while the truth of the empirical proposition is rough and oscillating, the mathematical proposition describes *its* object precisely and absolutely. As if, in fact, the 'mathematical sphere' were a sphere. And it might e.g. be asked whether there was only *one* such sphere, or several (a Fregean question).

Does a misunderstanding about the possible application constitute an objection to the calculation as a part of mathematics?

And apart from misunderstanding,--what about mere lack of clarity?

Page 261

Imagine someone who believes that mathematicians have discovered a queer thing, $\sqrt{-1}$, which when squared does yield - 1, can't he nevertheless calculate quite well with complex numbers, and apply such calculations in physics? And does this make them any the less *calculations*?

In *one* respect of course his understanding has a weak foundation; but he will draw his conclusions with certainty, and his calculus will have a *solid* foundation.

Page Break 262

Page 262

Now would it not be ridiculous to say this man wasn't doing mathematics?

Page 262

Someone makes an addition to mathematics, gives new definitions and discovers new theorems--and in a *certain* respect he can be said not to know what he is doing.--He has a vague imagination of having *discovered* something like a space (at which point he thinks of a room), of having opened up a kingdom, and when asked about it he would talk a great deal of nonsense.

Page 262

Let us imagine the primitive case of someone carrying out enormous multiplications in order, as he says, to conquer gigantic new provinces of the domain of numbers.

Page 262

Imagine calculating with $\sqrt{-1}$ invented by a madman, who, attracted merely by the paradox of the idea, does the calculation as a kind of service, or temple ritual, of the absurd. He imagines that he is writing down the impossible and operating with it.

Page 262

In other words: if someone believes in mathematical *objects* and their queer properties--can't he nevertheless do mathematics? Or--isn't he also doing mathematics?

Page 262

'Ideal object.' "The symbol '*a*' stands for an ideal object" is evidently supposed to assert something about the meaning, and so about the use, of '*a*'. And it means of course that this use is in a certain respect

Page Break 263

similar to that of a sign that has an object, and that it does not stand for any object. But it is interesting what the expression 'ideal object' makes of this fact.

Page 263

6. In certain circumstances we might speak of an endless row of marbles.--Let us imagine such an endless straight row of marbles at equal distances from one another; we calculate the force exerted by all these marbles on a certain body according to a certain law of attraction. We regard the number yielded by this calculation as the ideal of exactness for certain measurements.

Page 263

The feeling of something *queer* here comes from a misunderstanding. The kind of misunderstanding that is produced by a thumb-catching of the intellect--to which I want to call a halt.

Page 263

The objection that 'the finite cannot grasp the infinite' is *really* directed against the idea of a psychological act of grasping or understanding.

Page 263

Or imagine that we simply say: "This force corresponds to the attraction of an endless row of marbles which we have arranged in such-and-such a way and which attract the body according to such-and-such a law of attraction". Or again: "Calculate the force which an endless row of marbles of such-and-such a kind exerts on the body".--It certainly makes sense to give such an order. It describes a particular calculation.

Page Break 264

Page 264

What about the following question: "Calculate the weight of a pillar composed of as many slabs lying on top of one another as there are cardinal numbers; the undermost slab weighs 1 kg., and every higher one weighs half of the one just below it".

The difficulty is *not* that we can't form an image. It is easy enough to form some kind of image of an endless row, for example. The question is what use the image is to us.

Imagine infinite numbers used in a fairy tale. The dwarves have piled up as many gold pieces as there are cardinal numbers--etc. What can occur in this fairy tale must surely make sense.--

7. Imagine set theory's having been invented by a satirist as a kind of parody on mathematics.--Later a reasonable meaning was seen in it and it was incorporated into mathematics. (For if one person†1 can see it as a paradise of mathematicians, why should not another see it as a joke?)

The question is: even as a joke isn't it evidently mathematics?--

And why is it evidently mathematics?--Because it is a game with signs according to rules?

But isn't it evident that there are concepts formed here--even if we are not clear about their application? But how is it possible to have a concept and not be clear about its application?

8. Take the construction of the polygon of forces: isn't that a bit of applied mathematics? And where is the proposition of *pure* mathematics which is invoked in connexion with this graphical calculation? Is this case not like that of the tribe which has a technique of calculating in order to make certain predictions, but no propositions of pure mathematics?

Calculation that belongs to the performance of a ceremony. For example, let the number of words in a form of blessing that is to be applied to a home be derived by a particular technique from the ages of the father and mother and the number of their children. We could imagine procedures of calculating described in such a law as the Mosaic law. And couldn't we imagine that the nation with these ceremonial prescriptions for calculating never calculated in practical life?

This would indeed be a case of *applied* calculation, but it would not serve the purpose of a prediction.

Would it be any wonder if the technique of calculating had a family of applications?

9. We only see how queer the question is whether the pattern ϕ (a particular arrangement of digits e.g. '770') will occur in the infinite expansion of π , when we try to formulate the question in a quite common or garden way: men have been trained to put down signs according to certain rules. Now they proceed according to this training and we say that it is a problem whether they will *ever* write down the pattern ϕ in following the given rule.

But what are you saying if you say that one thing is clear: either one will come on ϕ in the infinite expansion, or one will not?

It seems to me that in saying this you are yourself setting up a rule or postulate.

What if someone were to reply to a question: 'So far there is no such thing as an answer to this question'?

So, e.g., the poet might reply when asked whether the hero of his poem has a sister or not--when, that is, he has not yet decided anything about it.

The question--I want to say--changes its status, when it becomes

decidable. For a connexion is made then, which formerly *was not there*.

Of someone who is trained we can ask 'How *will* he interpret the rule for this case?', or again 'How *ought* he to interpret the rule for this case?'--but what if no decision about this question has been made?--Well, then the answer is, not: 'he ought to interpret it in such a way that ϕ occurs in the expansion' or: 'he ought to interpret it in such a way that it does not occur', but: 'nothing has so far been decided about this'.

However queer it sounds, the further expansion of an irrational number is a further expansion of mathematics.

We do mathematics with concepts.--And with certain concepts more than with other ones.

I want to say: it *looks* as if a ground for the decision were already there; and it has yet to be invented.

Would this come to the same thing as saying: in thinking about the technique of expansion, which we have learnt, we use the false picture of a completed expansion (of what is ordinarily called a "row") and this forces us to ask unanswerable questions?

For after all in the end every question about the expansion of $\sqrt{2}$ must be capable of formulation as a practical question concerning the technique of expansion.

And what is in question here is of course not merely the case of the expansion of a real number, or in general the production of mathematical signs, but every analogous process, whether it is a game, a dance, etc., etc..

10. When someone hammers away at us with the law of excluded middle as something which cannot be gainsaid, it is clear that there is something wrong with his question.

When someone sets up the law of excluded middle, he is as it were putting two pictures before us to choose from, and saying that one must correspond to the fact. But what if it is questionable whether the pictures can be applied here?

And if you say that the infinite expansion must contain the pattern ϕ or not contain it, you are so to speak shewing us the picture of an unsurveyable series reaching into the distance.

But what if the picture began to flicker in the far distance?

11. To say of an unending series that it does *not* contain a particular

pattern makes sense only under quite special conditions.

That is to say: this proposition has been given a sense for certain cases.

Roughly, for those where it is in the *rule* for this series, not to contain the pattern....

Further: when I calculate the expansion further, I am deriving new rules which the series obeys.

"Good,--then we can say: 'It must either reside in the rule for this series that the pattern occurs, or the opposite.'" But is it like that?--"Well, doesn't the rule of expansion *determine* the series completely? And if it does so, if it allows of no ambiguity, then it must implicitly determine all questions about the structure of the series."--Here you are thinking of finite series.

"But surely all members of the series from the 1st up to 1,000th, up to the 10¹⁰-th and so on, are determined; so surely *all* the members are determined." That is correct if it is supposed to mean that it is not the case that e.g. the so-and-so-many'th is *not* determined. But you can see that *that* gives you no information about whether a particular pattern is going to appear in the series (if it has not appeared so far). *And so we can see* that we are using a misleading *picture*.

If you want to know more about the series, you have, so to speak, to get into another dimension (as it were from the line into a surrounding plane).--But then isn't the plane *there*, just like the line, and merely something to be *explored*, if one wants to know what the facts are?

No, the mathematics of this further dimension has to be invented just as much as any mathematics.

In an arithmetic in which one does not count further than 5 the question what $4 + 3$ makes doesn't yet make sense. On the other hand the problem may very well exist of giving this question a sense. That is to say: the question makes *no more* sense than does the law of excluded middle in application to it.

12. In the law of excluded middle we think that we have already got something solid, something that at any rate cannot be called in doubt. Whereas in truth this tautology has just as shaky a sense (if I may put it like that), as the question whether p or $\sim p$ is the case.

Suppose I were to ask: what is meant by saying "the pattern... occurs in this expansion"? The reply would be: "you surely *know* what it means. It occurs as the pattern... in fact occurs in the expansion."--So *that* is the way it occurs?--But *what way* is that?

Imagine it were said: "Either it occurs in that way, or it does not occur in that way"!

"But don't you really understand what is meant?"--But may I not believe I understand it, and be wrong?--

For how do I know what it means to say: the pattern... occurs in the expansion? Surely by way of examples--which shew me what it is like for.... But these examples do not shew me what it is like for this pattern to occur in the expansion!

Might one not say: if I really had a right to say that these examples tell me what it is like for the pattern to occur in the expansion, then they would also have to shew me what the opposite means.

13. The general proposition that that pattern does not occur in the expansion can only be a *commandment*.

Suppose we look at mathematical propositions as commandments, and even utter them as such? "Let 25^2 be 625."

Well--a commandment has an internal and an external negation.

The symbols " $(x).\phi x$ " and " $(\exists x).\phi x$ " are certainly useful in mathematics so long as one is acquainted with the technique of the proofs of the existence or non-existence to which the Russellian signs *here* refer. If however this is left open, then these concepts of the old logic are extremely misleading.

If someone says: "But you surely know what 'this pattern occurs in the expansion' means, namely *this*"--and points to a case of occurring,--then I can only reply that what he shews me is capable of illustrating a *variety* of facts. For that reason I can't be said to know what the proposition means just from knowing that he will certainly use it in this case.

The opposite of "there exists a law that p " is not: "there exists a law that $\sim p$ ". But if one expresses the first by means of P , and the second by means of $\sim P$, one will get into difficulties.

14. Suppose children are taught that the earth is an infinite flat surface; or that God created an infinite number of stars; or that a star keeps on moving uniformly in a straight line, without ever stopping.

Queer: when one takes something of this sort as a matter of course, as it were in one's stride, it loses its whole paradoxical aspect. It is as if I were to be told: Don't worry, this series, or movement, goes on without ever stopping. We are as it were excused the labour of thinking of an end.

Page 272

'We won't bother about an end.'

Page 272

It might also be said: 'for us the series is infinite'.

Page 272

'We won't worry about an end to this series; for us it is always beyond our ken.'

Page 272

15. The rational numbers cannot be *enumerated*, because they cannot be counted--but one can count with them, as with the cardinal numbers. That squint-eyed way of putting things goes with the whole system of pretence, namely that by using the new apparatus we deal with

Page Break 273

infinite sets with the same certainty as hitherto we had in dealing with finite ones.

Page 273

It should not have been called 'denumerable', but on the other hand it would have made sense to say 'numberable'. And this expression also informs us of an application of the concept. For one cannot set out to enumerate the rational numbers, but one can perfectly well set out to assign numbers to them.

Page 273

But where is the problem here? Why should I not say that what we call mathematics is a family of activities with a family of purposes?

Page 273

People might for example use calculating as a kind of competitive activity. As children do sometimes have races in doing sums; only this use of sums plays a quite subordinate role among us.

Page 273

Or multiplication might strike us as much more difficult than it does--if e.g. we only calculated orally, and in order to take note of, and so to grasp, a multiplication it were necessary to bring it into the form of rhyming verse. When someone succeeded in doing this he would have the feeling of having discovered a wonderful great truth.

Every new multiplication would require a new individual piece of work.

If these people believed that numbers were spirits and that they were

Page Break 274

exploring the domain of spirits by means of their calculations, or compelling the spirits to manifest themselves--would this now be arithmetic? Again--would it be arithmetic even in the case where these people used the calculations for nothing else?

Page 274

16. The comparison with alchemy seems natural. We might speak of a kind of alchemy in mathematics.

Page 274

Is it already mathematical alchemy, that mathematical propositions are regarded as statements about mathematical objects,--and mathematics as the exploration of these objects?

Page 274

In a certain sense it is not possible to appeal to the meaning of the signs in mathematics, just because it is only mathematics that gives them their meaning.

Page 274

What is typical of the phenomenon I am talking about is that a *mysteriousness* about some mathematical concept is not *straight away* interpreted as an erroneous conception, as a mistake of ideas; but rather as something that is at any rate not to be despised, is perhaps even rather to be respected.

Page 274

All that I can do, is to shew an easy escape from this obscurity and this glitter of the concepts.

Page Break 275

Strangely, it can be said that there is so to speak a solid core to all these glistening concept-formations. And I should like to say that that is what makes them into mathematical productions.

Page 275

It might be said: what you see does of course look more like a gleaming Fata Morgana; but look at it from another quarter and you can see the solid body, which only looks like a gleam without a corporeal substrate when seen from that other direction.

17. 'The pattern is in the series or it is not in the series' means: either the thing looks like *this* or it does not look like this.

How does one know what is meant by the opposite of the proposition " ϕ occurs in the series", or even of the proposition " ϕ does not occur in the series"? This question sounds like nonsense, but does make sense all the same.

Namely: how do I know that I understand the proposition " ϕ occurs in this series"?

True, I can give examples illustrating the use of such statements, and also of the opposite ones. And they are examples of there being a rule prescribing the occurrence in a definite region or series of regions, or determining that such an occurrence is excluded.

If "you do it" means: you must do it, and "you do not do it" means: you must not do it--then "Either you do it, or you do not" is not the law of excluded middle.

Everyone feels uncomfortable at the thought that a proposition can state that such-and-such does not occur in an infinite series--while on the other hand there is nothing startling about a command's saying that this must not occur in this series however far it is continued.

But what is the source of this distinction between: "however far you go you will never find this"--and "however far you go you must never do this"?

On hearing the proposition one can ask: "how can we know anything like that?" but nothing analogous holds for the command.

The statement seems to overreach itself, the command not at all.

Can we imagine all mathematical propositions expressed in the imperative? For example: "Let 10×10 be 100".

And if you now say: "Let it be like this, or let it not be like this", you are not pronouncing the law of excluded middle--but you are pronouncing a *rule*. (As I have already said above.)

18. But is this really a way out of the difficulty? For how about all

the other mathematical propositions, say ' $25^2 = 625$ '; isn't the law of excluded middle valid for these *inside* mathematics?

How is the law of excluded middle applied?

"Either there is a rule that prescribes it, or one that forbids it."

Assuming that there is no rule forbidding the occurrence,--why is there then supposed to be one that prescribes it?

Does it make sense to say: "While there isn't any rule forbidding the occurrence, as a matter of fact the pattern does not occur"?--And if this does not make sense, how can the opposite make sense, namely, that the pattern does occur?

Well, when I say it occurs, a picture of the series from its beginning up to the pattern floats before my mind--but if I say that the pattern *does* not occur, then no such picture is of any use to me, and my supply of pictures gives out.

What if the rule should bend in use without my noticing it? What I mean is, that I might speak of different spaces in which I use it.

The opposite of "it must not occur" is "it can occur". For a finite segment of the series, however, the opposite of "it must not occur in it" seems to be: "it must occur in it".

The queer thing about the alternative " ϕ occurs in the infinite series or it does not", is that we have to imagine the two possibilities individually, that we look for a distinct idea of each, and that *one* is not adequate for the negative and for the positive case, as it is elsewhere.

19. How do I know that the general proposition "There is..." makes sense here? Well, if it can be used to tell something about the technique of expansion in a language game.

In *one* case what we are told is: "it must not occur"--i.e.: if it occurs you calculated wrong.

In one case what we are told is: "it can occur", i.e., no such interdict exists. In another: "it must occur in such-and-such a region (always in this place in these regions)". But the opposite of this seems to be: "it must not occur in such-and-such places"--instead of "it *need* not occur there".

But what if the rule were given that, e.g., everywhere where the formation rule for π yields 4, any arbitrary digit other than 4 can be put in its place?

Consider also the rule which forbids one digit in certain places, but otherwise leaves the choice open.

Isn't it like this? The concepts of infinite decimals in mathematical

propositions are not concepts of series, but of the unlimited technique of expansion of series.

We learn an endless technique: that is to say, something is done for us first, and then we do it; we are told rules and we do exercises in following them; perhaps some expression like "and so on *ad inf.*" is also used, but what is in question here is not some gigantic extension.

These are the facts. And now what does it mean to say: " ϕ either occurs in the expansion, or does not occur"?

20. But does this mean that there is no such problem as: "Does the pattern ϕ occur in this expansion?"--To ask this is to ask for a rule regarding the occurrence of ϕ . And the alternative of the existence or non-existence of such a rule is at any rate not a mathematical one.

Only within a mathematical structure which has yet to be erected does the question allow of a *mathematical* decision, and at the same time become a demand for such a decision.

21. Then is infinity not actual--can I not say: "these two edges of the slab meet at infinity"?

Say, not: "the circle has this property because it passes through the two points at infinity..."; but: "the properties of the circle can be regarded in this (extraordinary) perspective".

It is essentially a perspective, and a far-fetched one. (Which does not express any reproach.) But it must always be quite clear *how far-fetched* this way of looking at it is. For otherwise its real *significance* is dark.

22. What does it mean to say: "the mathematician does not know what he is doing", or: "he knows what he is doing"?

23. Can one make infinite predictions?--Well, why should one not for example call the law of inertia one? Or the proposition that a comet describes a parabola?

In a certain sense of course the infinity of the prediction is not taken very seriously.

Now what about a *prediction* that if you expand π , however far you go, you will never come across the pattern ϕ ?--Well, we could say that this is either a *non-mathematical* prediction, or alternatively a mathematical rule.

Page 280

Someone who has learned to expand $\sqrt{2}$ goes to a fortune-teller, and she tells him that however far he may expand $\sqrt{2}$ he will never arrive at the pattern....--Is her soothsaying a mathematical proposition?

Page Break 281

No.--Unless she says: "If you always expand correctly you will never reach it". But is that still a prediction?

Page 281

Now it looks as if such a *prediction* of the correct expansion were imaginable and were distinct from a mathematical law that it *must* be thus and thus. So that in the mathematical expansion there would be a distinction between what as a matter of fact comes out like this--as it were accidentally--and what must come out.

Page 281

How is it to be decided whether an infinite prediction makes sense?

Page 281

At any rate not by one's saying: "I am certain I *mean* something when I say...".

Page 281

Besides, the question is not so much whether the prediction makes some kind of sense, as: what kind of sense it makes. (That is, in what language games it occurs.)

Page 281

24. "The disastrous invasion" of mathematics by logic.

Page 281

In a field that has been prepared in this way *this* is a proof of existence.

Page 281

The harmful thing about logical technique is that it makes us forget the special mathematical technique. Whereas logical technique is only an auxiliary technique in mathematics. For example it sets up certain

Page Break 282

connexions between different techniques.

Page 282

It is almost as if one tried to say that cabinet-making consisted in glueing.

Page 282

25. A proof convinces you that there is a root of an equation (without giving you any idea *where*)--how do you know that you understand the proposition that there is a root? How do you know that you are really convinced of anything? You may be convinced that the application of the proved proposition will turn up. But you do not understand the proposition so long as you have not found the application.

Page 282

When a proof proves in a general way that *there* is a root, then everything depends on the form in which it proves this. On what it is that here leads to this verbal expression, which is a mere shadow, and keeps mum about *essentials*. Whereas to logicians it seems to keep mum only about incidentals.

Page 282

Generality in mathematics does not stand to particularity in mathematics in the same way as the general to the particular elsewhere.

Page 282

Everything that I say really amounts to this, that one can know a proof thoroughly and follow it step by step, and yet at the same time not *understand* what it was that was proved.

Page Break 283

Page 283

And this in turn is connected with the fact that one can form a mathematical proposition in a grammatically correct way without understanding its meaning.

Now when does one understand it?--I believe: when one can apply it.

It might perhaps be said: when one has a clear picture of its application. For this, however, it is not enough to connect a clear picture with it. It would rather have been better to say: when one commands a clear view of its application. And even that is bad, for the matter is simply one of not imagining that the application is where it is not; of not being deceived by the verbal form of the proposition.

Page 283

But how does it come about that one can fail to understand, or can misunderstand, a proposition or proof in this way? And what is then necessary in order to produce understanding?

Page 283

There are here, I believe, cases in which someone can indeed apply the proposition (or proof), but is unable to give a clear account of the kind of application. And the case in which he is even unable to apply the proposition. (Multiplicative axiom.)†1

Page 283

How is it as regards $0 \times 0 = 0$?

Page Break 284

Page 284

One would like to say that the understanding of a mathematical proposition is not guaranteed by its verbal form, as is the case with most non-mathematical propositions. This means--so it appears--that the words don't determine the *language-game* in which the proposition functions.

Page 284

The logical notation swallows the structure.

Page 284

26. In order to see how something can be called an 'existence-proof', though it does not permit a construction of what exists, think of the different meanings of the word "where". (For example the topological and the metrical.)

Page 284

For it is not merely that the existence-proof can leave the place of the 'existent' undetermined: there need not be any question of such a place.

That is to say: when the proved proposition runs: "there is a number for which..." then it need not make sense to ask "and which number is it?", or to say "and this number is...".

Page 284

27. A proof that 777 occurs in the expansion of π , without shewing where, would have to look at this expansion from a totally new point of view, so that it shewed e.g. properties of regions of the expansion about which we only knew that they lay very far out. Only the picture floats before one's mind of having to assume as it were a dark zone of indeterminate length very far on in π , where we can no longer rely on our devices for calculating; and then still further out a zone where in a *different* way we can once more see something.

Page Break 285

Page 285

28. We can always imagine proof by *reductio ad absurdum* used in argument with someone who puts forward a non-mathematical assertion (e.g. that he has seen a checkmate with such-and-such pieces) which can be mathematically refuted.

Page 285

The difficulty which is felt in connexion with *reductio ad absurdum* in mathematics is this: what goes on in this proof? Something mathematically absurd, and hence unmathematical? How--one would like to ask--can one so much as assume the mathematically absurd at all? That I can assume what is physically false and reduce it *ad absurdum* gives me no difficulty. But how to think the--so to speak--unthinkable?

Page 285

What an indirect proof says, however, is: "If you want *this* then you cannot assume *that*: for only the opposite of what you do not want to abandon would be combinable with *that*".

Page 285

29. The geometrical illustration of Analysis is indeed inessential; not, however, the geometrical application. Originally the geometrical illustrations were *applications of Analysis*. Where they cease to be this they can be wholly misleading.

What we have then is the imaginary application. The fanciful application.

The idea of a 'cut' is one such dangerous illustration.

Page Break 286

Page 286

Only in so far as the illustrations are also applications do they avoid producing that special feeling of dizziness which the illustration produces in the moment at which it ceases to be a possible application; when, that is, it becomes stupid.

30. Dedekind's theorem could be derived, if what we call irrational numbers were *quite unknown*, but if there were a technique of deciding the places of decimals by throwing dice. And this theorem would then have its application even if the mathematics of irrational numbers did not exist. It is not as if Dedekind's expansions already foresaw all the special real numbers. It merely *looks* like that as soon as Dedekind's calculus is joined to the calculi of the special real numbers.

31. It might be asked: what is there about the proof of Dedekind's theorem that a child 10 years old could *not* understand?--For isn't this proof far simpler than all the calculations which the child has to master?--And if now someone were to say: it can't understand the deeper content of the proposition--then I ask: how does this proposition come to have a deep content?

32. The picture of the number line is an absolutely natural one up to a certain point; that is to say so long as it is not used for a general theory of real numbers.

33. If you want to divide the *real* numbers into an upper and lower class, then do it first crudely by means of

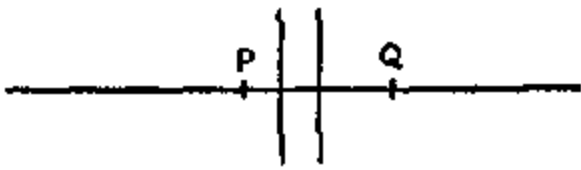

two rational points P and Q . Then halve PQ and decide in which half (if not at the point of division) the cut is supposed to lie; if for example in the lower one, halve this and make a more exact decision and so on.

If you have a principle for unlimited repetition of this procedure then you can say that this principle executes a cut, as it decides for each number whether it lies to the right or to the left.--Now the question is whether I can go all the way by means of such a principle of division, or whether some other way of deciding is still needed; and again, whether this would be *after* finishing the use of the principle, or *before*. Now in any case, not before the completion; for so long as the question still is, in which finite bit of the straight line the point is supposed to lie, further division may decide the matter.--But *after* the decision by a principle is there still room for a further decision?

It is the same with Dedekind's theorem as with the law of excluded middle: it seems to exclude a third possibility, whereas a third possibility is not in question here.

The proof of Dedekind's theorem works with a picture which cannot justify *it*; which ought rather to be justified by the theorem.

You readily see a principle of division as an unendingly repeated division, for at any rate it does not correspond to any finite division and seems to lead you on and on.

34. Couldn't we make a more *extensional preparation* for the theory of limits, functions, real numbers, than we do? Even if this preparatory calculus should seem *very* trivial and in itself useless?

The difficulty of looking at the matter now in an intensional, now again in an extensional way, is already there with the concept of a 'cut'. That every rational number can be called a principle of division of the rational numbers is perfectly clear. Now we discover something else that we can call a principle of division, e.g. what corresponds to $\sqrt{2}$. Then other similar ones--and now we are already quite familiar with the possibility of such divisions, and see them under the aspect of a cut made somewhere along the straight line, *hence extensionally*. For if I *cut*, I can of course choose where I want to cut.

But if a *principle* of division is a cut, it surely is so only because it is possible to say of any arbitrary rational number that it is on one side or the other of the cut. Can the idea of a cut now be said to have led us from the rational to the irrational numbers? Are we for example led to $\sqrt{2}$ by way of the concept of a cut?

Now what is a cut of the real numbers? Well, a principle of division into an upper and a lower class. Thus such a principle yields every rational and irrational number. For even if we have no system of irrational numbers, still

those *that we have* divide into upper and lower by reference to the cut (so far, that is, as they are comparable with it).

But now Dedekind's idea is that the division into an upper and lower class (under the known conditions) is the real number.

Page 288

The cut is an extensional *image*.

Page Break 289

Page 289

It is of course true that, if I have a mathematical criterion for establishing, for any arbitrary rational number, whether it belongs to the upper or the lower class, then it is easy for me systematically to approximate as close as I like to the place where the two classes meet.

Page 289

In Dedekind we do not make a cut by cutting, i.e. pointing to the place, but--as in finding $\sqrt{2}$ --by approaching the adjacent ends of the upper and the lower class.

Page 289

The thing now is to prove that no other numbers except the real numbers can perform such a cut.

Page 289

Let us not forget that the division of the rational numbers into two classes did not *originally* have any meaning, until we drew attention to a particular thing that could be so described. The concept *is taken over from the everyday use of language* and that is why it immediately looks as if it had to have a meaning for numbers too.

Page 289

When the idea of a cut of the *real* numbers is now introduced by saying that we simply have to extend the concept of a cut of the rational numbers to the real numbers--all that we need is a property dividing the real numbers into two classes (etc.)--then *first of all* it is not clear what is meant by such a property, which thus divides *all* real numbers. Now our attention can be drawn to the fact that any real number can serve this purpose. But that gets us only so far and no further.

Page Break 290

Page 290

35. The extensional definitions of functions, of real numbers etc. pass over--although they presuppose--everything intensional, and refer to the ever-recurring outward form.

Page 290

36. Our difficulty really already begins with the infinite straight line; although we learn even as children that a straight line has no end, and I do not know that this idea has ever given anyone any difficulty. Suppose a finitist were to try to replace this concept by that of a straight segment of definite length?!

But the straight line is a *law* for producing further.

Page 290

The concept of the limit and of continuity, as they are introduced nowadays, depend, without its being said, on the concept of *proof*. For we say

$$\lim_{x \rightarrow \infty} F(x) = 1 \text{ when it can be proved that...}$$

This means we use concepts which are infinitely harder to grasp than those that we make explicit.

Page 290

37. The misleading thing about Dedekind's conception is the idea that the real numbers are there spread out in the number line. They may be known or not; that does not matter. And in this way all that one needs to do is to cut or divide into classes, and one has dealt with them all.

Page 290

It is by *combining calculation and construction* that one gets the idea that there must be a point left out on the straight line, namely *P*,

Page Break 291

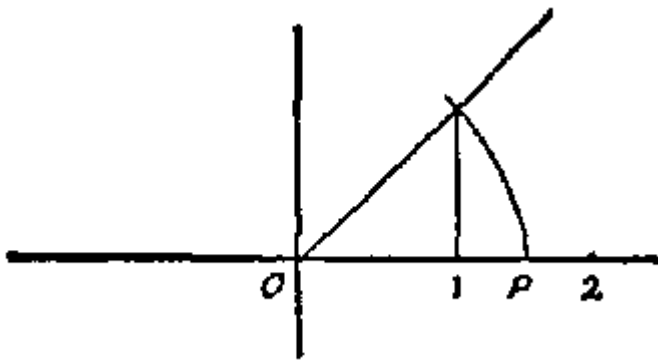

if one does not admit $\sqrt{2}$ as a measure of distance from O . 'For, if I were to construct really accurately, then the circle would have to cut the straight line *between* its points.'

Page 291

This is a frightfully confusing picture.

Page 291

The irrational numbers are--so to speak--special cases.

Page 291

What is the *application* of the concept of a straight line in which a point is missing?! The application must be 'common or garden'. The expression "straight line with a point missing" is a fearfully misleading picture. The yawning gulf between illustration and application.

Page 291

38. The generality of functions is so to speak an *unordered* generality. And our mathematics is built up on such an unordered generality.

Page 291

39. If one imagines the general calculus of functions without the existence of examples, then the vague explanations by means of value-tables

Page Break 292

and diagrams, such as are found in the textbooks, are in place as *indications* of how e.g. a sense might sometime be given to this calculus.

Page 292

Imagine someone's saying: "I want to hear a composition which goes like this":



Page 292

Would that necessarily be senseless? Couldn't there be a composition whose correspondence to this line, in some important sense, could be shewn?

Page 292

Or suppose one looked at continuity as a property of the sign ' $x^2 + y^2 = z^2$ '--of course only if this equation and others were *ordinarily* subjected to a known method of testing. *This* is the relation of this rule (equation) to this particular test.' A test, which goes with a sidelong glance at a kind of extension.

Page 292

In this test of the equation something is undertaken which is connected with certain extensions. Though not as if what were in question here were an extension which would be somehow equivalent to the equation itself. It is just that certain extensions are, so to speak, alluded to.--The real thing here is not the extension, which is only *faute de mieux* described intensionally; rather is the *intension* described--or

Page Break 293

presented--by means of certain extensions, which are yielded by it then and there.

Page 293

The range of certain extensions casts a *sidelight* on the algebraic property of the function. In this sense, then, the drawing of a hyperbola could be said to cast a sidelight on the equation of the hyperbola.

Page 293

It is no contradiction of this for those extensions to be the most important application of the rule; for it is *one* thing to draw an ellipse, and another to construct it *by means of its equation*--

Page 293

Suppose I were to say: extensional considerations (for example the Heine-Borel theorem) shew: *This* is how to deal with intensions.

Page 293

The theorem gives us the main features of a method of proceeding with intensions. It says e.g.: '*this* is what it will have to be like'.

Page 293

And it will then be possible to attach a diagram as a particular illustration, e.g. to a procedure with particular intensions. The illustration is a sign, a description, which is particularly easy to take in, particularly memorable.

Page 293

To give the illustration here will in fact be to give a procedure.

Page Break 294

Page 294

A theory of the placing of figures in a picture (a painting),--say on general aesthetic grounds--*apart from* whether these figures are engaged in fighting, or love-making etc..

Page 294

The theory of functions as a schema, into which on the one hand a host of examples fits, and which on the other hand is there as a standard for the classification of cases.

Page 294

The misleading thing about the usual account consists in its looking as if the *general* account could be quite understood even without examples, without a thought of intensions (in the plural), since really everything could be managed extensionally, if that were not impossible for external reasons.

Page 294

Compare the two forms of definition: "We say

$$\lim_{x \rightarrow \infty} \phi(x) = L \text{ when it can be shewn that..."}$$

and

$$\text{"}\lim_{n \rightarrow \infty} \phi(n) = L \text{ means: for every } \epsilon \text{ there is a } \delta \text{..."}$$

Page 294

40. Dedekind gives a general pattern of expression; so to speak a logical form of reasoning.

A general formulation of a procedure. The effect is similar to that of introducing the word "correlation" with a view to the general definition of functions. A general way of talking is introduced, which is very useful for the characterization of a mathematical procedure (as in Aristotelian logic). But the danger is that one will think one is in

Page Break 295

possession of the complete explanation of the individual cases when one has this general way of talking (the same danger as in logic).

Page 295

We determine the concept of *the rule* for the construction of a non-terminating decimal further and further.

But the content of the concept?!--Well, can we not complete the construction of the concept as a receptacle for whatever application may turn up? May I not complete the construction of the *form* (the form for which some content has supplied me with the *stimulus*) and as it were prepare a form of language for possible employment? For, so long as it remains empty, the form will contribute to determining the form of mathematics.

Page 295

For isn't the subject-predicate form open in this way; and waiting for the most various new applications?

Page 295

That is to say: is it true that the whole difficulty about the generality of the concept of a mathematical

function is already to be found in Aristotelian logic, since we can no more survey the generality of propositions and of predicates than that of mathematical functions?

Page 295

41. Concepts which occur in 'necessary' propositions must also occur and have a meaning in non-necessary ones.

Page 295

42. Would one say that someone understood the proposition ' $563 + 437 = 1000$ ' if he did not know how it can be proved? Can

Page Break 296

one deny that it is a sign of understanding a proposition, if a man knows how it could be proved?

Page 296

The problem of finding a mathematical decision of a theorem might with some justice be called the problem of giving mathematical sense to a formula.

Page 296

An equation links two concepts; so that I can now pass from one to the other.

Page 296

An equation constructs a conceptual path. But is a conceptual path a concept? And if not, is there a sharp distinction between them?

Page 296

Imagine that you have taught someone a technique of multiplying. He uses it in a language-game. In order not to have to keep on multiplying afresh, he writes the multiplication in an abbreviated form as an equation, and he uses this where he multiplied before.

Now he says that the technique of multiplying establishes connexions between the concepts. He will also say the same thing about a multiplication as a picture of this transition. And finally he will say the same thing about the equation itself: for it is essential that the transition should be capable of being represented simply by the pattern of the equation. That is, that the transition should *not* always have to be made anew.

Now will he also be inclined to say that the process of multiplying is a concept?

Page Break 297

Page 297

It is surely a *movement*. It seems to be a movement between two stationary points; these are the concepts.

Page 297

If I conceive a proof as my *movement* from one concept to another, then I shall not want also to say that it is a new concept. But can I not conceive the written multiplication as *one* picture, comparable to a number-sign, and may not its functioning include functioning as a concept-sign?

Page 297

43. I should like to say: when we employ now the one, now the other side of the equation, we are employing two sides of the same concept.

Page 297

44. Is the conceptual apparatus a concept?

Page 297

45. How does anyone shew that he understands a mathematical proposition? E.g. by applying it. So not also by proving it?

Page 297

I should like to say: the proof shews me a new connexion, and hence it also gives me a new concept.

Page 297

Is not the new concept the proof itself?

Page Break 298

Page 298

But a proof certainly does enable you to form a new judgment. For you can after all say of a particular pattern that it is or is not this proof.

Page 298

Yes, but is the proof, regarded, interpreted, as a *proof*, a pattern? As a *proof*, I might say, it has to convince me of something. In consequence of it I will do or not do something. And in consequence of a new concept I don't do or not do anything. So I want to say: the proof is the pattern of proof employed in a particular way.

And what it convinces me of can be of very various kinds. (Think of the proofs of Russellian tautologies, or proofs in geometry and in algebra.)

Page 298

A mechanism can convince me of something (can prove something). But under what circumstances--in the context of what activities and problems--shall I say that it convinces me of something?

Page 298

"But a concept surely does not convince me of anything, for it does not shew me a fact."--But why should a concept not first and foremost convince me that I want to use *it*?

Page 298

Why should not the new concept, once formed, immediately license my transition to a judgment?

Page 298

46. 'Understanding a mathematical proposition'--that is a very vague concept.

Page Break 299

Page 299

But if you say "The point isn't understanding at all. Mathematical propositions are only positions in a game" that too is nonsense! 'Mathematics' is *not* a sharply delimited concept.

Page 299

Hence the issue whether an existence-proof which is not a construction is a real proof of existence. That is, the question arises: Do I *understand* the proposition "There is..." when I have no possibility of finding where it exists? And here there are two points of view: as an English sentence for example I understand it, so far, that is, as I can explain it (and note how far my explanation goes). But what can I do with it? Well, not what I can do with a constructive proof. And in so far as what I can do with the proposition is the criterion of understanding it, thus far it is not clear *in advance* whether and to what extent I understand it.

The curse of the invasion of mathematics by mathematical logic is that now any proposition can be represented in a mathematical symbolism, and this makes us feel obliged to understand it. Although of course this method of writing is nothing but the translation of vague ordinary prose.

Page 299

47. A concept is not essentially a predicate.†1 We do indeed sometimes say: "This thing is not a bottle" but it is certainly not essential to the language-game with the concept 'bottle' that such judgments occur in it. The thing is to pay attention to how a concept word ("slab", e.g.) is used in a language-game.

Page Break 300

Page 300

There need not e.g. be such a sentence as "This is a slab" at all; but e.g. merely: "Here is a slab."

Page 300

48. 'Mathematical logic' has completely deformed the thinking of mathematicians and of philosophers, by setting up a superficial interpretation of the forms of our everyday language as an analysis of the structures of facts. Of course in this it has only continued to build on the Aristotelian logic.

Page 300

49. It is quite true: the numerical sign belongs with a concept-sign, and only together with this is it, so to speak, a measure.

Page 300

50. If you look into this mouse's jaw you will see two long incisor teeth.--How do you know?--I know that all mice have them, so this one will too. (And one does not say: "And this thing is a mouse, so it too...") Why is this such an important move? Well, we investigate e.g. animals, plants etc. etc.; we form general judgments and apply them in particular cases.--But it surely is a truth that this mouse has the property, *if all* mice have it! That is a determination about the application of the word "all". The factual generality is to be found somewhere else. Namely, for example, in the general occurrence of that method of investigation and its application.

Page 300

Or: "This man is a student of mathematics." How do you know?--"All the people in this room are mathematicians; only such people have been admitted."

Page Break 301

Page 301

The interesting case of generality is this: we often have a means of ascertaining the general proposition before

considering particular cases: and we then use the general method to judge the particular case.

We gave the porter the order only to admit people with invitations and now we count upon it that this man, who has been admitted, has an invitation.

Page 301

The interesting generality in the case of the logical proposition is not the fact that it appears to express, but the ever-recurring situation in which this transition is made.

Page 301

51. If it is said that the proof shews *how* (e.g.) 25×25 yield 625, that is of course a queer way of talking, since for this to be the arithmetical result is not a temporal process. But the proof does not shew any temporal process either.

Page 301

Imagine a sequence of pictures. They shew how two people fence with rapiers according to such-and-such rules. A sequence of pictures can surely shew that. Here the picture refers to a reality. It cannot be said to shew *that* fencing is done like this, but *how* fencing is done. In another sense we can say that the pictures shew how one can get from this position into that in three movements. And now they also shew *that* one can get into that position in this way.

Page 301

52. The philosopher must twist and turn about so as to pass by the mathematical problems, and not run up against one,--which would have to be solved before he could go further.

Page Break 302

Page 302

His labour in philosophy is as it were an idleness in mathematics.

Page 302

It is not that a new building has to be erected, or that a new bridge has to be built, but that the geography, *as it now is*, has to be described.

Page 302

We certainly see bits of the concepts, but we don't clearly see the declivities by which one passes into others.

Page 302

This is why it is of no use in the philosophy of mathematics to recast proofs in new forms. Although there is a strong temptation here.

Page 302

Even 500 years ago a philosophy of mathematics was possible, a philosophy of what mathematics was then.

Page 302

53. The philosopher is the man who has to cure himself of many sicknesses of the understanding before he can arrive at the notions of the sound human understanding.

Page Break 303

PART VI

ca. 1943/1944

Page 303

1. Proofs give propositions an order. They organize them.

Page 303

2. The concept of a formal test presupposes the concept of a transformation-rule, and hence of a technique.

Page 303

For only through a technique can we *grasp* a regularity.

Page 303

The technique is external to the pattern of the proof. One might have a perfectly accurate view of the proof, yet not understand it as a transformation according to such-and-such rules.

Page 303

One will certainly call adding up the numbers ... to see whether they come to 1000, a formal test of the numerals. But all the same that is *only* when adding is a practised technique. For otherwise how could the procedure be called any kind of test?

Page 303

It is only within a *technique* of transformation that the proof is a formal test.

Page Break 304

Page 304

When you ask what right you have to pronounce this rule, the proof is the answer to your question.

Page 304

What right have you to say that? *What* right have you to say it?

Page 304

How do you test a theme for a contrapuntal property? You transform it according to *this* rule, you put it together with another one in *this* way; and the like. In this way you get a definite result. You get it, as you would also get it by means of an experiment. So far what you are doing may even have been an experiment. The word "get" is here used temporally; you got the result at three o'clock.--In the mathematical proposition which I then frame the verb ("get", "yields" etc.) is used non-temporally.

The activity of testing produced such and such a result.

So up to now the testing was, so to speak, experimental. Now it is taken as a proof. And the proof is the *picture* of a test.

Page 304

The proof, like the application, lies in the background of the proposition. And it hangs together with the application.

Page 304

The proof is the route taken by the test.

Page 304

The test is a formal one only in so far as we conceive the result as the result of a formal proposition.

Page Break 305

Page 305

3. And if this picture justifies the prediction--that is to say, if you only have to see it and you are convinced that a procedure will take such-and-such a course--then naturally this picture also justifies the rule. In this case the proof stands behind the rule as a picture that justifies the rule.

Page 305

For why does the picture of the movement of the mechanism justify the belief that this kind of mechanism will always move in *this* way?--It gives our belief a particular direction.

Page 305

When the proposition seems not to be right in application, the proof must surely shew me why and how it *must* be right; that is, *how* I must reconcile it with experience.

Page 305

Thus the proof is a blue-print for the employment of the rule.

Page 305

4. How does the proof justify the rule?--It shews how, and therefore why, the rule can be used.

Page 305

The King's Bishop†1 shews us how 8×9 makes 72--but here the rule of counting is not acknowledged as a rule.

The King's Bishop shews us *that* 8×9 makes 72: Now we are acknowledging the rule.

Page Break 306

Page 306

Or ought I to have said: the King's Bishop shews me how 8×9 *can* make 72; that is to say, it shews me a way?

Page 306

The procedure shews me a How of '*making*'.

Page 306

In so far as $8 \times 9 = 72$ is a rule, of course it means nothing to say that that shews me *how* $8 \times 9 = 72$; unless this were to mean: someone shews me a process through the contemplation of which one is led to this rule.

Page 306

Now isn't going through any proof such a process?

Page 306

Would it mean anything to say: "I want to shew you how 8×9 originally made 72"?

Page 306

5. What is really queer is that the picture, not the reality, should be able to prove a proposition! As if here the

picture itself took over the role of reality.--But that's not how it is: for what I derive from the picture is only a rule. And this rule does not stand to the picture as an empirical proposition stands to reality.--The picture of course does not shew that such-and-such happens. It only shews that what does happen can be taken in *this* way.

Page 306

The proof shews how one proceeds according to the rule without a hitch.

Page Break 307

Page 307

And so one may even say: the procedure, the proof, shews one how far $8 \times 9 = 72$.

Page 307

The picture shews one, not, of course, anything that happens, but that what ever does happen will allow of being looked at like this.

Page 307

We are brought to the point of using this technique in this case. I am brought to this--and *to that extent* I am convinced of something.

Page 307

See, in this way 3 and 2 make 5. Note this procedure. "In doing so you at once notice the rule."

Page 307

6. The Euclidean proof of the infinity of prime numbers might be so conducted that the investigation of the numbers between p and $p! + 1$ was carried out on one or more examples, and in this way we learned a technique of investigation. The force of the proof would of course in that case not reside in the fact that a prime number $> p$ was found in *this* example. And at first sight this is queer.

It will now be said that the algebraic proof is stricter than the one by way of examples, because it is, so to speak, the extract of the effective principle of these examples. But after all, even the algebraic proof is not quite naked. Understanding--I might say--is needed for both!

Page 307

The proof teaches us a technique of finding a prime number between p and $p! + 1$. And we become convinced that this technique must

Page Break 308

always lead to a prime number $> p$. Or that we have miscalculated if it doesn't.

Page 308

Would one be inclined to say here that the proof shews us *how* there is an infinite series of prime numbers? Well, one might say so. And at any rate: "What there being an infinity of primes amounts to." For it could also be imagined that we had a proof that did indeed determine us to say that there were infinitely many primes, but did not teach us to find a prime number $> p$.

Now perhaps it would be said: "Nevertheless, these two proofs prove the same proposition, the same mathematical fact." There might be reason at hand for saying this, or again there might not.

Page 308

7. The spectator sees the whole impressive procedure. And he becomes convinced of something; that is the special impression that he gets. He goes away from the performance convinced of something. Convinced that (for example) he will end up the same way with other numbers. He will be ready to express what he is convinced of in such-and-such a way. Convinced of what? Of a psychological fact?--

Page 308

He will say that he has drawn a conclusion from what he has seen.--*Not*, however as one does from an experiment. (Think of periodic division.)

Page 308

Could he say: "What I have seen was very impressive. I have drawn a conclusion from it. In future I shall..."?

Page Break 309

Page 309

(E.g.: In future I shall always calculate like *this*.)

Page 309

He tells us: "I saw that it must be like that."

Page 309

"I realised that it must be like that"--that is his report.

Page 309

He will now perhaps run through the proof procedure in his mind.

Page 309

But he does not say: I realised that *this* happens. Rather: that it must be like that. This "must" shews what kind of lesson he has drawn from the scene.

The "must" shews that he has gone in a circle.

Page 309

I decide to see things like *this*. And so, to act in such-and-such a way.

Page 309

I imagine that whoever sees the process also draws a moral from it.

Page 309

'It must be so' means that this outcome has been defined to be essential to this process.

Page 309

8. This *must* shews that he has adopted a concept.

Page Break 310

Page 310

This *must* signifies that he has gone in a circle.

Page 310

He has read off from the process, not a proposition of natural science but, instead of that, the determination of a concept.

Let concept here mean method. In contrast to the application of the method.

Page 310

9. See, 50 and 50 make 100 like *this*. One has, say, added 10 to 50 five times in succession. And one goes on with the increase of the number until it grows to 100. Here of course the observed process would be a process of calculating in some fashion (on the abacus, perhaps); a proof.

Page 310

The meaning of that "like *this*" is of course not that the proposition " $50 + 50 = 100$ " says: this takes place somewhere. So it is not as when I say: "See, a horse canters like this"--and shew him a picture.

Page 310

One could however say: "See, *this* is *why* I say $50 + 50 = 100$ ".

Page 310

Or: See, *this* is how one gets $50 + 50 = 100$.

But if I now say: See, *this* is how 3 + 2 make 5, laying 3 apples on the table and then 2 more, here I mean to say: 3 apples and 2 apples

Page Break 311

make 5 apples, if none are added or taken away.--Or one might even tell someone: If you put 3 apples and then 2 more on the table (as I am doing), then what you see now almost always happens--and there are now 5 apples lying there.

I want perhaps to shew him that 3 apples and 2 apples don't make 5 apples in *such* a way as they might make 6 (because e.g. one makes a sudden appearance). This is really an explanation, a definition of the operation of adding. This is indeed how one might actually explain adding with the abacus.

Page 311

"If we put 3 things by 2 things, that may yield various counts of things. But we see as a *norm* the procedure that 3 things and 2 things make 5 things. See, *this* is how it looks when they make 5."

Page 311

Couldn't one say to a child: "Shew me how 3 and 2 make 5." And the child would then have to calculate 3 + 2 on the abacus.

Page 311

When, in teaching the child to calculate, one asks, "How do 3 + 2 make 5?"--what is he supposed to shew? Well, obviously he is supposed to move three beads up to 2 beads and then to count the beads (or something like that).

Page 311

Might one not say "Shew me how this theme makes a canon." And someone asked this would have to prove that it does make a canon.--One would ask someone "*how*" if one wanted to to get him to shew that he does grasp what is in question here.

And if the child now shews how 3 and 2 make 5, then he shews a procedure that can be regarded as a ground for the rule "2 + 3 = 5."

10. But suppose one asks the pupil: "Shew me how there are infinitely many prime numbers."--Here the grammar is doubtful! But it would be appropriate to say: "Shew me in how far one may say that there are infinitely many prime numbers."

When one says "Shew me that it is...," then the question *whether it is* is already put and it remains only to answer "yes" or "no". But if one says "Shew me *how* it is that...", then here the language-game itself needs to be explained. At any rate, one has so far no *clear* concept of what one is supposed to be at with this assertion. (One is asking, so to speak; "How can such an assertion be justified at all?")

Now am I meant to give different answers to the question: "Shew me *how*..." and "Shew me *that*..."?

From the proof you derive a theory. If you derive a theory from the proof, then the sense of the theory must be independent of the proof; for otherwise the theory could never have been separated from the proof.

In the same way as I can remove auxiliary construction lines in a drawing and leave the rest.

Thus it is as if the proof did not determine the sense of the proposition proved; and yet as if it did determine it.

But isn't it like that with any verification of any proposition?

11. I believe this: Only in a large context can it be said at all that there are infinitely many prime numbers. That is to say: For this to be possible there must already exist an extended technique of calculating with cardinal numbers. That proposition only makes sense within this technique. A proof of the proposition locates it in the whole system of calculations. And its position therein can now be described in more than one way, as of course the whole complicated system in its background is presupposed.

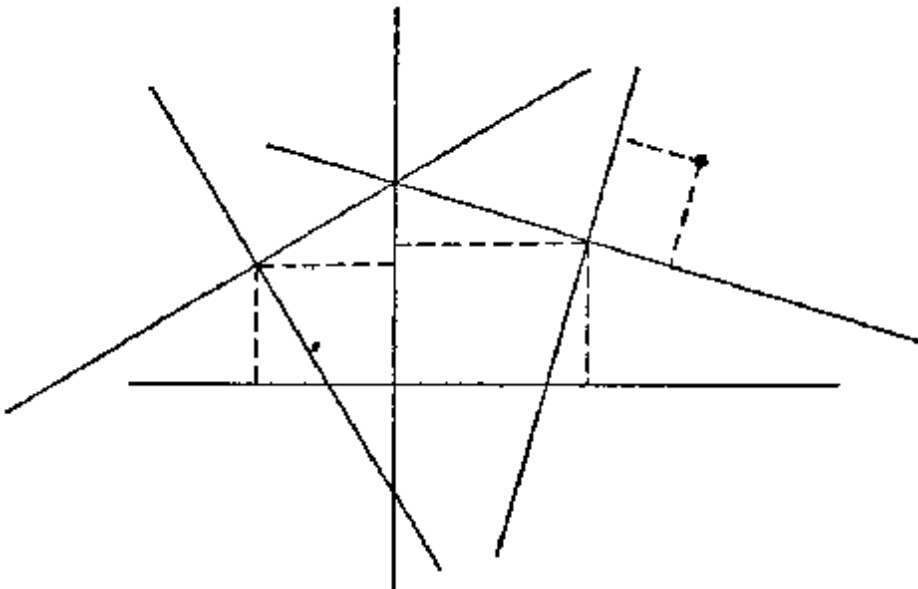

If for example 3 co-ordinate systems are given a definite mutual arrangement, I can determine the position of a point for all of them by giving it for any one.

The proof of a proposition certainly does not mention, certainly does not describe, the whole system of calculation that stands behind the proposition and gives it its sense.

Assume that an adult with intelligence and experience has learnt only the first elements of calculation, say the four fundamental operations with numbers up to 20. In doing so he has also learnt the word "prime number". And suppose someone said to him "I am going to prove to you that there are infinitely many prime numbers." Now, how can he prove it to him? He has got to *teach him to calculate*. That is here part of the proof. It takes that, so to speak, to give the question "Are there infinitely many prime numbers?" any sense.

Page 314
 12. Philosophy has to work things out in face of the temptations to misunderstand on *this* level of knowledge. (On another level there are again new temptations.) But that doesn't make philosophising any easier!

Page 314
 13. Now isn't it absurd to say that one doesn't understand the sense of Fermat's last theorem?--Well, one might reply: the mathematicians are not *completely* blank and helpless when they are confronted by this proposition. After all, they try certain methods of proving it; and, so far as they try methods, *so far* do they understand the proposition.--But is that correct? Don't they *understand* it just as completely as one can possibly understand it?

Page 314
 Now let us assume that, quite contrary to mathematicians' expectations, its contrary were proved. So now it is shewn that it *cannot* be so at all.

Page 314
 But, if I am to know what a proposition like Fermat's last theorem says, must I not know what the criterion is, for the proposition to be true? And I am of course acquainted with criteria for the truth of

Page Break 315
similar propositions, but not with any criterion for the truth of this proposition.

Page 315
 'Understanding' is a vague concept.

Page 315
 In the first place, there is such a thing as *belief* that one understands a proposition. And if understanding is a psychical process--why should it interest us so much? Unless experience connects it with the capacity to make use of the proposition.

Page 315
 "Shew me how..." means: shew me the connexions in which you are using this proposition (this machine-part).

Page 315
 14. "I am going to shew you how there are infinitely many prime numbers" presupposes a condition in which the proposition that there are infinitely many prime numbers had no, or only the vaguest, meaning. It might have been merely a joke to him, or a paradox.

Page 315
 If this procedure convinces you of that, then it must be very impressive.--But is it?--Not particularly. Why is it not *more* so? I believe it would only be impressive if one were to explain it quite radically. If for example one did not merely write $p! + 1$, but first explained it and illustrated it with examples. If one did not presuppose the techniques as something obvious, but gave an account of them.

Page Break 316

Page 316

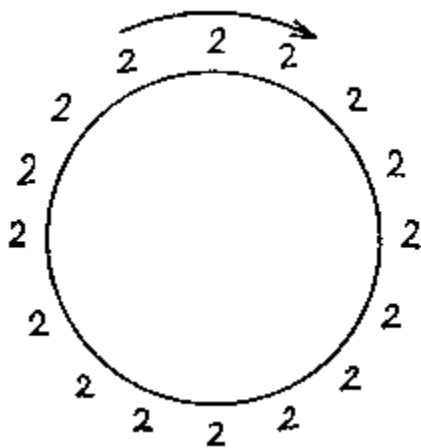

15.

We keep on copying the last figure "2" going round to the right. If we copy correctly, the last figure is in turn a copy

of the first one.

Page 316

A language-game:



Page 316

One person (A) predicts the result to another (B). The other follows the arrows with excitement, as it were curious how they will conduct him, and is pleased at the way they end by leading him to the predicted result. He reacts to it perhaps as one reacts to a joke.

A may have constructed the result before, or merely have guessed it. B knows nothing about it and it does not interest him.

Page 316

Even if he was acquainted with the rule, still he had never followed it *thus*. He is *now* doing something new. But there is also such a thing as curiosity and surprise when one has already travelled this road. In this way one can read a story again and again, even know it by heart, and yet keep on being surprised at a particular turn that it takes.

Page Break 317

Page 317

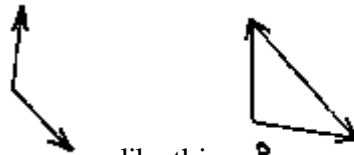

Before I have followed the two arrows like this  , I don't know how the route or the result will look. I do not know what face I shall see. Is it strange that I did not know it? How should I have known it? I had never seen it! I knew the rule and had mastered it and I saw the sheaf of arrows.

Page 317

But why wasn't this a genuine prediction: "If you follow the rule, you will produce this"? Whereas the following is certainly a genuine prediction: "If you follow the rule as best you can, you will..." The answer is: the first is not a prediction because I might also have said: "If you follow the rule, you *must* produce this." It is not a prediction if the concept of *following* the rule is so determined, that the result is the criterion for whether the rule was followed.

Page 317

A says: "If you follow the rule you will get *this*" or he says simply: "You will get this." At the same time he draws the resulting arrow there.

Page 317

Now was what A said in this game a prediction? Well damn it, Yes--in a certain sense. Does that not become particularly clear if we make the suggestion that the prediction was *wrong*? It was only not a prediction in the case where the *condition* turned the proposition into a pleonasm.

Page Break 318

Page 318

A might have said: "If you are in agreement with each of your steps, then you will arrive *at this*."

Page 318

Suppose that while B is deriving the polygon, the arrows of the sheaf were to alter their direction a little. B always draws an arrow parallel, as it is just at this moment. He is now just as surprised and excited as in the foregoing game, although here the result is not that of a calculation. So he had taken the first game in the same way as the second.

Page 318

The reason why "If you follow the rule, this is where you'll get to" is not a prediction is that this proposition simply says: "The result of this calculation is..." and that is a true or false mathematical proposition: The allusion to the future and to yourself is mere clothing.

Page 318

Now must A have a clear idea at all, of whether his prediction is meant mathematically or otherwise? He

simply says "If you follow the rule... will result" and enjoys the game. If for example the predicted result does not come out, he does not investigate any further.

Page 318

16. ... And this series is defined by a rule. Or again by the training in proceeding according to the rule. And the inexorable proposition is that according to this rule this number is the successor of this one.†1

Page Break 319

Page 319

And this proposition is not an empirical one. But why not an empirical one? A rule is surely something that we go by, and we produce one numeral out of another. Is it not matter of experience, that this rule takes someone from here to there?

Page 319

And if the rule + 1 carries him one time from 4 to 5, perhaps another time it carries him from 4 to 7. Why is that impossible?

Page 319

The question arises, what we take as criterion of going according to the rule. Is it for example a feeling of satisfaction that accompanies the act of going according to the rule? Or an intuition (intimation) that tells me I have gone right? Or is it certain practical consequences of proceeding that determine whether I have really followed the rule?--In that case it would be possible that $4 + 1$ sometimes made 5 and sometimes something else. It would be thinkable, that is to say, that an experimental investigation would shew whether $4 + 1$ always makes 5.

Page 319

If it is not supposed to be an empirical proposition that the rule leads from 4 to 5, then *this*, the result, must be taken as the criterion for one's having gone by the rule.

Page 319

Thus the truth of the proposition that $4 + 1$ makes 5 is, so to speak, *overdetermined*. Overdetermined by this, that the result of the operation is defined to be the criterion that this operation has been carried out.

Page Break 320

Page 320

The proposition rests on one too many feet to be an empirical proposition. It will be used as a determination of the concept 'applying the operation + 1 to 4'. For we now have a new way of judging whether someone has followed the rule.

Page 320

Hence $4 + 1 = 5$ is now itself a rule, by which we judge proceedings.

This rule is the result of a proceeding that we assume as *decisive* for the judgment of other proceedings. The rule-grounding proceeding is the proof of the rule.

Page 320

17. How does one describe the process of learning a rule?--If A claps his hands, B is always supposed to do it too.

Page 320

Remember that the description of a language-game is already a description.

Page 320

I can train someone in a *uniform* activity. E.g. in drawing a line like this with a pencil on paper:



Now I ask myself, what is it that I want him to do, then? The answer is: He is always to go on as I have shewn him. And what do I really mean by: he is always to go on in that way? The best answer to this that I can give myself, is an example like the one I have just given.

Page Break 321

Page 321

I would use this example in order to shew him, and *also* to shew myself, what I mean by uniform.

Page 321

We talk and act. That is already presupposed in everything that I am saying.

Page 321

I say to him "That's right," and this expression is the bearer of a tone of voice, a gesture. I leave him to it. Or I say "No!" and hold him back.

18. Does this mean that 'following a rule' is indefinable? No. I can surely define it in countless ways. Only definitions are no use to me in these considerations.

19. I might also teach him to understand an order of the form:

$$(- \cdot \cdot) \rightarrow \text{ or } (- \cdot \cdot \cdot -) \rightarrow$$

(Let the reader guess what I mean.)

Now what do I mean him to do? The best answer that I can give myself to this is to carry these orders on a bit further. Or do you believe that an algebraic expression of this rule presupposes less?

And now I train him to follow the rule

$$- \cdot - \cdot - \cdot \cdot \cdot \text{ etc.}$$

And again I don't myself know any more about what I want from him, than what the example itself shews. I can of course paraphrase the rule in all sorts of different forms, but that makes it more intelligible only for someone who can already follow these paraphrases.

20. This, then, is how I have taught someone to count and to multiply in the decimal system, for example. "365 × 428" is an order and he complies with it by carrying out the multiplication.

Here we insist on this, that the same sum that is set always has the same multiplication-pattern in its train, and so the same result. Different patterns of multiplication for the same set sum we reject.

The situation will now arise, of a calculator making mistakes in calculation; and also of his correcting mistakes.

A further language-game is this: He gets asked "How much is '365 × 428'?" And he may act on this question in two different ways. Either he does the multiplication, or if he has already done it before, he reads off the previous result.

21. The application of the concept 'following a rule' presupposes a custom. Hence it would be nonsense to say: just once in the history of

the world someone followed a rule (or a signpost; played a game, uttered a sentence, or understood one; and so on).

Here there is nothing more difficult than to avoid pleonasm and only to say what really describes something.

For here there is an overwhelming temptation to say something more, when everything has already been described.

It is of the greatest importance that a dispute hardly ever arises between people about whether the colour of this object is the same as the colour of that, the length of this rod the same as the length of that, etc. This peaceful agreement is the characteristic surrounding of the use of the word "same".

And one must say something analogous about proceeding according to a rule.

No dispute breaks out over the question whether a proceeding was according to the rule or not. It doesn't come to blows, for example.

This belongs to the framework, out of which our language works (for example, gives a description).

22. Now someone says that in the series of cardinal numbers that obeys the rule $+ 1$, the technique of which was taught to us in such-and-such a way, 450 succeeds 449. That is not the empirical proposition that we come from 449 to 450 when it strikes us that we have applied the operation $+ 1$ to 449. Rather is it a stipulation that only when the result is 450 have we applied this operation.

It is as if we had hardened the empirical proposition into a rule. And now we have, not an hypothesis that gets tested by experience, but a paradigm with which experience is compared and judged. And so a new kind of judgment.

For one judgment is: "He worked out 25×25 , was attentive and conscientious in doing so and made it 615"; and another: "He worked out 25×25 and got 615 out instead of 625."

But don't the two judgments come to the same thing in the end?

The arithmetical proposition is not the empirical proposition: "When I do *this*, I get *this*"--where the criterion for my doing *this* is not supposed to be what results from it.

23. Might we not imagine that the main point in multiplying was the concentration of the mind in a definite way, and that indeed one didn't always work out the same sums the same way, but for the particular practical problems that we want to solve, just these differences of result were advantageous?

Is the main thing not this: that in *calculating* the main weight would be placed on whether one has calculated right or wrong, quite prescindng from the psychical condition etc. of the person who is doing the calculation?

The justification of the proposition $25 \times 25 = 625$ is, naturally, that if anyone has been trained in such-and-such a way, then under normal circumstances he gets 625 as the result of multiplying 25 by 25. But the arithmetical proposition does not *assert that*. It is so to speak an empirical proposition hardened into a rule. It stipulates that the rule has been followed only when that is the result of the multiplication. It is thus withdrawn from being checked by experience, but now serves as a paradigm for judging experience.

If we want to make practical use of a calculation, we convince ourselves that it has been "worked out right", that the *correct* result has been obtained. And there can be only *one* correct result of (e.g.) the multiplication; it doesn't depend on what you get when you *apply* the calculation. Thus we judge the facts by the aid of the calculation and quite differently from the way in which we should do so, if we did not regard the result of the calculation as something determined once for all.

Not empiricism and yet realism in philosophy, that is the hardest thing. (Against Ramsey.)

You do not yourself understand any more of the rule than you can explain.

24. "I have a particular concept of the rule. If in this sense one follows it, then from that number one can only arrive at this one". That is a spontaneous decision.

But why do I say "I *must*", if it is my decision? Well, may it not be that I must decide?

Doesn't its being a spontaneous decision merely mean: that's how I act; ask for no reason!

You say you must; but cannot say what compels you.

I have a definite concept of the rule. I know what I have to do in any particular case. I know, that is I am in no doubt: it is obvious to me. I say "Of course". I can give no reason.

When I say "I decide spontaneously", naturally that does not mean: I consider which number would really be the best one here and then plump for...

Page 326

We say: "First the calculations must be done right, and then it will be possible to pass some judgment on the facts of nature."

Page Break 327

Page 327

25. Someone has learned the rule of counting in the decimal system. Now he takes pleasure in writing down number after number in the "natural" number series.

Or he follows the rule in the language-game "Write down the successor of the number in the series"--How can I explain this language-game to anyone? Well, I can describe an example (or examples).--In order to see whether he has understood the language-game, I may make him work out examples.

Page 327

Suppose someone were to verify the multiplication tables, the logarithm tables etc., because he did not trust them. If he reaches a different result, he trusts it, and says that his mind had been so concentrated on the rule that the result it gets must count as the right one. If someone points out a mistake to him he says that he would rather doubt the trustworthiness of his own understanding and his own meaning *now* than then when he first made the calculation.

Page 327

We can take agreement for granted in all questions of calculation. But now, does it make any difference whether we utter the proposition used in calculating as an empirical proposition or as a rule?

Page 327

26. Should we acknowledge the rule $25^2 = 625$, if we did not all arrive at this result? Well, why then should we not be able to make use of the empirical proposition instead of the rule?--Is the answer to that: Because the contrary of the empirical proposition does not correspond to the contrary of the rule?

Page 327

When I write down a bit of a series for you, that you then see *this*

Page Break 328

regularity in it may be called an empirical fact, a psychological fact. But, *if* you have seen this law in it, that you then continue the series in *this* way--that is no longer an empirical fact.

But how is it not an empirical fact?--for "seeing *this* in it" was presumably not the *same* as: continuing it like this.

One can only say that it is not an empirical proposition, by *defining* the step on this level as the one that corresponds to the expression of the rule.

Page 328

Thus you say: "By the rule that *I* see in this sequence, it goes on in *this* way." Not: according to experience! Rather: that just is the meaning of this rule.

Page 328

I understand: You say "that is not according to experience"--but still *isn't* it according to experience?

Page 328

"By this rule it goes like *this*": i.e., you *give* this rule an extension.

Page 328

But why can't I give it this extension today, that one tomorrow?

Page 328

Well, so I can. I might for example alternately give one of two interpretations.

Page 328

27. If I have once grasped a rule I am bound in what I do further. But of course that only means that I am bound in my *judgment* about

Page Break 329

what is in accord with the rule and what not.

Page 329

If I now see a rule in the sequence that is given me--can that simply consist in, for example, my seeing an algebraic expression before me? Must it not belong to a language?

Page 329

Someone writes up a sequence of numbers. At length I say: "Now I understand it; I must always..." And this *is* the expression of a rule. *But*, only within a language!

Page 329

For when do I say that I see the rule--or a rule--in this sequence? When, for example, I can talk to myself about this sequence in a particular way. But surely also when I simply can continue it? No, I give myself or someone else a general explanation of how it is to be continued. But might I not give this explanation purely in the mind, and so without any real language?

Page 329

28. Someone asks me: What is the colour of this flower? I answer: "red".--Are you absolutely sure? Yes, absolutely sure! But may I not have been deceived and called the wrong colour "red"? No. The certainty with which I call the colour "red" is the rigidity of my measuring-rod, it is the rigidity from which I start. When I give descriptions, *that* is not to be brought into doubt. This simply characterizes what we call describing.

(I may of course even here assume a slip of the tongue, but nothing else.)

Page Break 330

Page 330

Following according to the rule is FUNDAMENTAL to our language-game. It characterizes what we call description.

Page 330

This is the similarity of my treatment with relativity-theory, that it is so to speak a consideration about the clocks with which we compare events.

Page 330

Is $25^2 = 625$ a fact of experience? You'd like to say: "No".--Why isn't it?--"Because, by the rules, it can't be otherwise."--And why so?--Because *that* is the meaning of the rules. Because that is the procedure on which we build all judging.

Page 330

29. When we carry out a multiplication, we give a law. But what is the difference between the law and the empirical proposition that we give this law?

Page 330

When I have been taught the rule of repeating the ornament



and now I have been told "Go on like that": how do I know what I have to do the next time?--Well, I do it with certainty, I shall also know how to defend what I do--that is, up to a certain point. If that does not count as a defence then there is none.

Page 330

"As I understand the rule, *this* comes next."

Page Break 331

Page 331

Following a rule is a human activity.

Page 331

I give the rule an extension.

Page 331

Might I say: See here, if I follow the order I draw this line? Well in certain cases I shall say that. When for example I have constructed a curve according to an equation.

Page 331

"See here! if I follow the order I do *this*!" That is naturally not supposed to mean: if I follow the order I follow the order. So I must have a different identification for the "this".

Page 331

"So *that's* what following this order looks like!"

Page 331

Can I say: "Experience teaches me: if I take the rule like *this* then *this* is how I must go on?"

Page 331

Not if I make 'taking it so' one and the same with 'continuing so'.

Page 331

Following a rule of transformation is not more problematic than following the rule: "keep on writing the same". For the transformation is a kind of identity.

Page Break 332

Page 332

30. It might however be asked: if all humans that are educated like this also calculate like *this*, or at least agree to *this* calculation as the right one; then what does one need the *law* for?

Page 332

" $25^2 = 625$ " cannot be the empirical proposition that people calculate like that, because $25^2 \neq 626$ would in that case not be the proposition that people get not this but another result; and also it could be true if people did not calculate at all.

Page 332

The agreement of people in calculation is not an agreement in opinions or convictions.

Page 332

Could it be said: "In calculating, the rules strike you as inexorable; you feel that you can only do that and nothing else if you want to follow the rule"?

Page 332

"As I see the rule, *this* is what it requires." It does not depend on whether I am disposed this way or that.

Page 332

I feel that I have given the rule an interpretation before I have followed it; and that this interpretation is enough to *determine* what I have to do in order to follow it in the particular case.

If I take the rule as I have taken it, then only doing *this* will correspond to it.

Page Break 333

Page 333

"Have you understood the rule?"--Yes, I have understood--"Then apply it now to the numbers....." If I want to follow the rule, have I now any choice left?

Page 333

Assuming that he orders me to follow the rule and that I am frightened not to obey him: am I now not compelled?

But that is surely so too if he orders me: "Bring me this stone." Am I compelled less by *these* words?

Page 333

31. To what extent can the function of language be described? If someone is not master of a language, I may bring him to a mastery of it by training. Someone who is master of it, I may remind of the kind of training, or I may describe it; for a particular purpose; thus already using a technique of the language.

To what extent can the function of a rule be described? Someone who is master of none, I can only train. But how can I explain the nature of a rule to myself?

The difficult thing here is not, to dig down to the ground; no, it is to recognize the ground that lies before us as the ground.

Page 333

For the ground keeps on giving us the illusory image of a greater depth, and when we seek to reach this, we keep on finding ourselves on the old level.

Page 333

Our disease is one of wanting to explain.

Page 333

"Once you have got hold of the rule, you have the route traced for you."

Page Break 334

Page 334

32. What sort of public must there be if a game is to exist, if a game can be invented?

Page 334

What surrounding is needed for someone to be able to invent, say, chess?

Of course I might invent a board-game today, which would never actually be played. I should simply describe it. But that is possible only because there already exist similar games, that is because such games *are played*.

Page 334

One might also ask: is regularity possible *without* repetition?

I may give a new rule today, which has never been applied, and yet is understood. But would that be possible, if no rule had *ever* actually been applied?

And if it is now said: "Isn't it enough for there to be an imaginary application?" the answer is: No. (Possibility of a private language.)

A game, a language, a rule is an institution.

"But how often must a rule have actually been applied, in order for one to have the right to speak of a rule?" How often must a human being have added, multiplied, divided, before we can say that he has

mastered the technique of these kinds of calculation? And by that I don't mean: how often must he have calculated right in order to convince *others* that he can calculate? No, I mean: in order to prove it to himself.

33. But couldn't we imagine that someone without any training should see a sum that was set to do, and straightway find himself in the mental state that in the normal course of things is only produced by training and practice? So that he knew he could calculate although he had never calculated. (One might, then, it seems, say; The training would merely be history, and merely as a matter of empirical fact would it be necessary for the production of knowledge.)--But suppose now he is in that state of certainty and he calculates wrong? What is he supposed to say himself? And suppose he then multiplied sometimes right, sometimes again quite wrong.--The training may of course be overlooked as mere history, if he now *always* calculates right. But that he *can* calculate he shews, to himself as well as to others only by this, that he *calculates* correctly.

What, in a complicated surrounding, we call "following a rule" we should certainly not call that if it stood in isolation.

34. Language, I should like to say, relates to a *way* of living.

In order to describe the phenomenon of language, one must describe a practice, not something that happens once, *no matter of what kind*.

It is very hard to realize this.

Let us imagine a god creating a country instantaneously in the middle of the wilderness, which exists for two minutes and is an exact reproduction of a part of England, with everything that is going on there in two minutes. Just like those in England, the people are pursuing a variety of occupations. Children are in school. Some people are doing mathematics. Now let us contemplate the activity of some human being during these two minutes. One of these people is doing exactly what a mathematician in England is doing, who is just doing a calculation.--Ought we to say that this two-minute-man is calculating? Could we for example not imagine a past and a continuation of these two minutes, which would make us call the processes something quite different?

Suppose that these beings did not speak English but apparently communicated with one another in a language that we are not acquainted with. What reason should we have to say that they were speaking a language? And yet *could* one not conceive what they were doing as that?

And suppose that they were doing something that we were inclined to call "calculating"; perhaps because its outward appearance was similar.--But *is* it calculating; and do (say) the people who are doing it know, though we do not?

35. How do I know that the colour that I am now seeing is called "green"? Well, to confirm it I might ask other people; but if they did not agree with me, I should become totally confused and should perhaps

take them or myself for crazy. That is to say: I should either no longer trust myself to judge, or no longer react to what they say as to a judgement.

If I am drowning and I shout "Help!", how do I know what the word "Help" means? Well, that's how I react in this situation.--Now *that* is how I know what "green" means as well and also know how I have to follow the rule in the particular case.

Page 337

Is it *imaginable* that the polygon of forces of

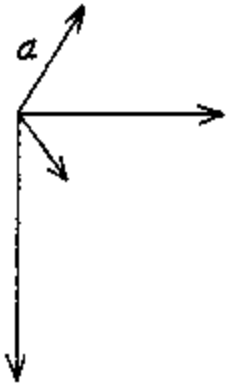

looks, not like this:

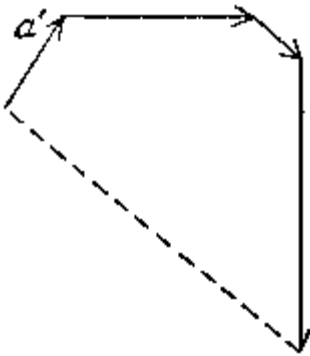

but otherwise? Well, is it imaginable that the parallel to *a* should not look to have the direction of *a'* but a different direction? That is to say: is it imaginable that I should regard not *a'* but a differently directed arrow as parallel to *a*?

Well, I might for example imagine that I was somehow seeing the parallel lines in perspective and so I call parallel arrows, and that it never occurs to me that I have been using a different way of looking at them. Thus, then, it *is* imaginable that I should draw a different polygon of forces corresponding to the arrows.

Page Break 338

Page 338

36. What sort of proposition is this: "There are four sounds in the word *OBEN*"?

Is it an empirical proposition?

Page 338

Before we have counted the letters, we don't know it.

Page 338

Someone who counts the letters in the word 'OBEN' in order to find out how many sounds there are in a sequence that sounds like that, does just the same thing as someone who counts in order to find out how many letters there are in the word that is written in such-and-such a place. So the former is doing something that might also be an experiment. And that might be reason to call the proposition that 'OBEN' has four letters synthetic *a priori*.

Page 338

The word "Plato" has as many sounds in it as the pentacle has corners. Is that a proposition of logic?--Is it an empirical proposition?

Page 338

Is counting an experiment? It *may* be one.

Page 338

Imagine a language-game in which someone has to count the sounds in a word. Now it might be that a word

apparently always had the same sound, but that when we count its sounds we come to different numbers on different occasions. It might be, for example, that a word did seem to us to sound the same in different contexts (as it were by an acoustical illusion) but the difference emerged when we counted the sounds. In such a case we shall perhaps keep on counting the

Page Break 339

sounds of a word on different occasions, and this will perhaps be a kind of experiment.

On the other hand it may be that we count the sounds in words once for all, make a calculation, and make use of the result of this counting.

The resulting proposition will in the first case be a temporal one, in the second it will be non-temporal.

Page 339

When I count the sounds in the word "Daedalus" I can regard the result in two different ways: (1) The word that is written there (or looks like this or was just now pronounced or etc.) has 7 sounds. (2) The sound-pattern "Dædalus" has 7 sounds.

The second proposition is timeless.

The employment of the two propositions must be different.

The *counting* is the same in the two cases. Only, what we reach by means of it is different.

Page 339

The timelessness of the second proposition is not e.g. a result of the counting, but of the decision to employ the result of counting in a particular way.

Page 339

In English the word Dædalus has 7 sounds. That is surely an empirical proposition.

Page 339

Imagine that someone counted the sounds in words in order to find or test a linguistic law, say a law of development of language. He says: "Dædalus' has 7 sounds". That's an empirical proposition. Consider

Page Break 340

here the *identity* of the word. The same word may here have now this, now that number of sounds.

Page 340

Now I tell someone: "Count the sounds in these words and write down the number by each word."

Page 340

I should like to say: "Through counting the sounds one may get an empirical proposition--but also one may get a rule."

Page 340

To say: "The word.... has.... sounds--in the timeless sense" is a determination about the identity of the concept 'The word....'. Hence the timelessness.

Page 340

Instead of "The word.... has.... sounds--in the timeless sense," one might also say: "The word.... has *essentially*.... sounds."

Page 340

$$\begin{aligned} p|p \cdot | \cdot q|q &= p \cdot q \\ p|q \cdot | \cdot p|q &= pq \\ 37. \quad x|y \cdot | \cdot z|u &\stackrel{\text{Def}}{=} || (x, y, z, u) \end{aligned}$$

Page 340

Definitions would not at all need to be abbreviations; they might make new connexions in another way. Say by means of brackets or the use of different colours for the signs.

Page Break 341

Page 341

I may for example prove a proposition by using colours to indicate that it has the form of one of my axioms, lengthened by a certain substitution.

Page 341

38. "I know how I have to go" means: I am in no doubt how I have to go.

Page 341

"How can one follow a rule?" That is what I should like to ask.

Page 341

But how does it come about that I want to ask that, when after all I find no kind of difficulty in following a rule?

Page 341

Here we obviously misunderstand the facts that lie before our eyes.

Page 341

How can the word "Slab" indicate what I have to do, when after all I can bring any action into accord with any interpretation?

Page 341

How can I follow a rule, when after all whatever I do can be interpreted as following it?

Page 341

What must I know, in order to be able to obey the order? Is there some *knowledge*, which makes the rule followable only in *this* way?

Page Break 342

Sometimes I must *know* something, *sometimes* I must *interpret* the rule before I apply it.

Now, *how* was it possible for the rule to have been given an interpretation during instruction, an interpretation which reaches as far as to any arbitrary step?

And if this step was not named in the explanation, how then *can* we agree about what has to happen at this step, since after all whatever happens can be brought into accord with the rule and the examples?

Thus, you say, nothing definite has been said about these steps.

Page 342

Interpretation comes to an end.

Page 342

39. It is true that *anything* can be somehow justified. But the phenomenon of language is based on regularity, on agreement in action.

Page 342

Here it is of the greatest importance that all or the enormous majority of us agree in certain things. I can, e.g., be quite sure that the colour of this object will be called 'green' by far the most of the human beings who see it.

Page 342

It would be imaginable that humans of different stocks possessed languages that all had the same vocabulary, but the meanings of the words were different. The word that meant green among one tribe, meant same among another, table for a third and so on. We could even

Page Break 343

imagine that the same sentences were used by the tribes, only with entirely different senses.

Page 343

Now in this case I should not say that they spoke the same language.

Page 343

We say that, in order to communicate, people must agree with one another about the meanings of words. But the criterion for this agreement is not just agreement with reference to definitions, e.g., ostensive definitions--but *also* an agreement in judgments. It is essential for communication that we agree in a large number of judgments.

Page 343

40. Language-game (2), †1 how can I explain it to someone, or to myself? Whenever A shouts "Slab" B brings *this* kind of object.--I might also ask: how can *I* understand it? Well, *only* as far as I can explain it.

Page 343

But there is here a queer temptation which expresses itself in my inclination to say: I cannot understand it, because the interpretation of the explanation is still vague.

Page Break 344

Page 344

That is to say, both to you and to myself I can only give examples of the application.

Page 344

41. The word "agreement" and the word "rule" are *related*, they are cousins. The phenomena of agreement and of acting according to a rule hang together.

Page 344

There might be a cave-man who produced *regular* sequences of marks for himself. He amused himself, e.g., by drawing on the wall of the cave:

— • — — • — — • — — — •

or

— • — • — • — • — • — • — • —

But he is not following the general expression of a rule. And when we say that he acts in a regular way that is not because we can form such an expression.

Page 344

But suppose he now developed π ! (I mean without a general expression of the rule.)

Page 344

Only in the practice of a language can a word have meaning.

Page 344

Certainly I can give myself a rule and then follow it.--But is it not a rule only for this reason, that it is analogous to what is called 'rule' in human dealings?

Page Break 345

Page 345

When a thrush always repeats the same phrase several times in its song, do we say that perhaps it gives itself a rule each time, and then follows the rule?

Page 345

42. Let us consider very simple rules. Let the expression be a figure, say this one:

| - - |

and one follows the rule by drawing a straight sequence of such figures (perhaps as an ornament).

| - - || - - || - - || - - || - - |

Under what circumstances should we say: someone gives a rule by writing down such a figure? Under what circumstances: someone is following this rule when he draws that sequence? It is difficult to describe this.

Page 345

If one of a pair of chimpanzees once scratched the figure | - - | in the earth and thereupon the other the series | - - || - - | etc., the first would not have given a rule nor would the other be following it, whatever else went on at the same time in the mind of the two of them.

If however there were observed, e.g., the phenomenon of a kind of instruction, of shewing how and of imitation, of lucky and misfiring attempts, of reward and punishment and the like; if at length the one who had been so trained put figures which he had never seen before one after another in sequence as in the first example, then we should probably say that the one chimpanzee was writing rules down, and the other was following them.

Page 345

43. But suppose that already the first time the one chimpanzee had *purposed* to repeat this procedure? Only in a particular technique of

Page Break 346

acting, speaking, thinking, can someone purpose something. (This 'can' is the grammatical 'can'.)

Page 346

It is possible for me to invent a card-game today, which however never gets played. But it means nothing to say: in the history of mankind just once was a game invented, and that game was never played by anyone. That means nothing. Not because it contradicts psychological laws. Only in a quite definite surrounding do the words "invent a game" "play a game" make sense.

Page 346

In the same way it cannot be said either that just once in the history of mankind did someone follow a sign-post. Whereas it can be said that just once in the history of mankind did some walk parallel with a board. And that first impossibility is again not a psychological one.

Page 346

The words "language", "proposition", "order", "rule", "calculation", "experiment", "following a rule" relate to a technique, a custom.

Page 346

A preliminary step towards acting according to a rule would be, say, pleasure in simple regularities such as the tapping out of simple rhythms or drawing or looking at simple ornaments. So one might train someone to obey

the order: "draw something regular", "tap regularly". And here again one must imagine a particular technique.

Page Break 347

Page 347

You must ask yourself: under what special circumstances do we say that someone has "made a mere slip of the pen" or "he could perfectly well have gone on, but on purpose did not do so" or "he had meant to repeat the figure that he drew, but he happened not to do it".

Page 347

The concept "regular tapping", "regular figure", is taught us in the same way as 'light-coloured' or 'dirty' or 'gaudy'.

Page 347

44. But aren't we guided by the rule? And how can it guide us, when its expression can after all be interpreted by us both thus and otherwise? I.e. when after all various regularities correspond to it. Well, we are inclined to say that an expression of the rule guides us, i.e., we are inclined to use this metaphor.

Page 347

Now what is the difference between the proceeding according to a rule (say an algebraic expression) in which one derives number after number according to the series, and the following proceeding: When we shew someone a

certain sign, e.g. , a numeral occurs to him; if he looks at the numeral and the sign, another numeral occurs to him and so on. And each time we engage in this experiment the same series of numerals occurs to him. Is the difference between this proceeding and that of going on according to the rule the psychological one that in the second case we have something occurring to him? Might I not say: When he was following the rule "|- -|", then "| - - |" kept on occurring to him?

Page 347

Well in our own case we surely have intuition, and people say that intuition underlies acting according to a rule.

Page Break 348

Page 348

So let us assume that that, so to speak, magical sign produces the series 123123123 etc.: is the sign *then* not the expression of a rule? No.

Acting according to a rule presupposes the recognition of a *uniformity* and the sign "123123123 etc." was the natural expression of a uniformity.

Page 348

Now perhaps it will be said that | 22 || 22 || 22 | is indeed a uniform sequence of marks but surely

| 2 || 22 || 222 || 2222 |

is not.

Page 348

Well, I might call this another kind of uniformity.

Page 348

45. Suppose however there were a tribe whose people apparently had an understanding of a kind of regularity which I do not grasp. That is they would also have learning and instruction, quite analogous to that in § 42. If one watches them one would say that they follow rules, learn to follow rules. The instruction effects, e.g., agreement in actions on the part of pupil and teacher. But if we look at one of their series of figures we can see no regularity of any kind.

What should we say now? We *might* say: "They appear to be following a rule which escapes us," but also "Here we have a phenomenon of behaviour on the part of human beings, which we don't understand".

Page 348

Instruction in acting according to the rule can be described without employing "and so on".

What can be described in this description is a gesture, a tone of voice, a sign which the teacher uses in a particular way in giving instruction, and which the pupils imitate. The effect of these expressions can also

Page Break 349

be described, again without calling 'and so on' to our aid, i.e. finitely. The effect of "and so on" will be to produce agreement going beyond what is done in the lessons, with the result that we all or nearly all count the same and calculate the same.

It would be possible, though, to imagine the very instruction without any "and so on" in it. But on leaving school the people would still all calculate the same beyond the examples in the instruction they had had.

Suppose one day instruction no longer produced agreement?

Could there be arithmetic without agreement on the part of calculators?

Could there be only one human being that calculated? Could there be only one that followed a rule?

Are these questions like, say, this one: "Can one man alone engage in commerce?"

It only makes sense to say "and so on" when "and so on" is *understood*. I.e., when the other is as capable of going on as I am, i.e., does go on just as I do.

Could two people engage in trade with one another?

46. When I say: "If you follow the rule, this *must* come out," that doesn't mean: it must, because it always has. Rather, that it comes out is one of my *foundations*.

What *must* come out is a foundation of judgment, which I do not touch.

On what occasion will it be said: "If you follow the rule this *must* come out"?

This may be a mathematical definition given in the train of a proof that a particular route branches. It may also be that one says it to someone in order to impress the nature of a rule upon him, in order to tell him something like: "You are *not* making an experiment here".

47. "But at every step I know absolutely what I have to do; what the rule demands of me." The rule, as I conceive it. I don't reason. The picture of the rule makes it clear how the picture of the series is to be continued.

"But I know at every step what I have to do. I see it quite clear before me. It may be boring, but there is no doubt what I have to do."

Whence this certainty? But why do I ask that question? Is it not enough that this certainty exists? What for should I look for a source of it? (And I can indeed give *causes* of it.)

When someone, whom we fear to disobey, orders us to follow the rule... which we understand, we shall write down number after number without any hesitation. And that is a typical kind of reaction to a rule.

"You already know how it is"; "You already know how it goes on."

I can now determine to follow the rule $(- \cdot -) \rightarrow$.

Like this: $-- \cdot - - \cdot - - \cdot - - \cdot -$

But it is remarkable that I don't lose the meaning of the rule as I do it. For how do I hold it fast?

But--how do I know that I do hold it fast, that I do not lose it?! It makes no sense at all to say I have held it fast unless there is such a thing as an outward mark of this. (If I were falling through space I might hold something, but not hold it still.)

Language just is a phenomenon of human life.

48. One person makes a bidding gesture, as if he meant to say "Go!" The other slinks off with a frightened expression. Might I not call this procedure "order and obedience", even if it happened only once?

What is this supposed to mean: "Might I not call the proceeding----"? Against any such naming the objection could naturally be made, that among human beings other than ourselves a quite different

gesture corresponds to "Go away!" and that perhaps our gesture for this order has among them the significance of our extending the hand in token of friendship. And whatever interpretation one has to give to a gesture depends on other actions, which precede and follow the gesture.

As we employ the word "order" and "obey", gestures no less than words are intertwined in a net of multifarious relationships. If I am now construing a simplified case, it is not clear whether I ought still to call the phenomenon "ordering" and "obeying".

We come to an alien tribe whose language we do not understand. Under what circumstances shall we say that they have a chief? What will occasion us to say that this man is the chief even if he is more poorly clad than others? The one whom the others obey--is he without question the chief?

What is the difference between inferring wrong and not inferring? between adding wrong and not adding? Consider this.

49. What you say seems to amount to this, that logic belongs to the natural history of man. And that is not combinable with the hardness of the logical "must".

But the logical "must" is a component part of the propositions of logic, and these are not propositions of human natural history. If what a proposition of logic said was: Human beings agree with one another in such and such ways (and that would be the form of the natural-historical proposition), then its contradictory would say that there is here a *lack* of agreement. Not, that there is an agreement of another kind.

The agreement of humans that is a presupposition of logic is not an agreement in *opinions*, much less in opinions on questions of logic.

PART VII

1941 and 1944

1. The role of propositions which deal with measures and are not 'empirical propositions'.--Someone tells me: "this stretch is two hundred and forty inches long". I say: "that's twenty foot, so it's roughly seven paces" and now I have got an idea of the length.--The transformation is founded on arithmetical propositions and on the proposition that 12 inches = 1 foot.

No one will ordinarily see this last proposition as an empirical proposition. It is said to express a convention. But measuring would entirely lose *its ordinary character* if, for example, putting 12 bits each one inch long end to end didn't ordinarily yield a length which can in its turn be preserved in a special way.

Does this mean that I have to say that the proposition '12 inches = 1 foot' asserts all those things which give measuring its present point?

No. The proposition *is grounded in* a technique. And, if you like, also in the physical and psychological facts that make the technique *possible*. But it doesn't follow that its sense is to express these conditions. The opposite of that proposition, 'twelve inches = one foot' does not say that rulers are not rigid enough or that we don't all count and calculate in the same way.

2. The proposition has the typical (but that doesn't mean *simple*) role of a rule.

I can use the proposition '12 inches = 1 foot' to make a prediction; namely that twelve inch-long pieces of wood laid end to end will turn out to be of the same length as one piece measured in a different way. Thus the point of that rule is, e.g., that it can be used to make certain predictions. Does it lose the character of a *rule* on that

account?

Page 356

Why can one make those predictions? Well,--all rulers are made alike; they don't alter much in length; nor do pieces of wood cut up into inch lengths; our memory is good enough for us not to take numbers twice in counting up to '12', and not to leave any out; and so on.

Page 356

But then can the rule *not* be replaced by an empirical proposition saying that rulers are made in such and such ways, that people do *this* with them? One might give an ethnological account of this human institution.

Page 356

Now it is evident that this account could take over the function of a rule.

Page 356

If you know a mathematical proposition, that's not to say you yet know anything. If there is confusion in our operations, if everyone calculates differently, and each one differently at different times, then there isn't any calculating yet; if we agree, then we have only set our watches, but not yet measured any time.

If you know a mathematical proposition, that's not to say you yet know *anything*.

I.e., the mathematical proposition is only supposed to supply a framework for a description.

Page Break 357

Page 357

3. How can the mere transformation of an expression be of practical consequence?

Page 357

The fact that I have 25×25 nuts can be verified by my counting 625 nuts, but it can also be discovered in another way which is closer to the form of expression ' 25×25 '. And of course it is in the linking of these two ways *of determining* a number that one point of multiplying lies.

Page 357

A rule *qua* rule is detached, it stands as it were alone in its glory; although what gives it importance is the facts of daily experience.

Page 357

What I have to do is something like describing the office of a king;--in doing which I must never fall into the error of explaining the kingly dignity by the king's usefulness, but I must leave neither his usefulness nor his dignity out of account.

Page 357

I am guided in practical work by the result of transforming an expression.

Page 357

But in that case how can I still say that it means the same thing whether I say "here are 625 nuts", or "here are 25×25 nuts"?

Page Break 358

Page 358

If you verify the proposition "here are 625 ..." then in doing that you are also verifying "here are 25×25 ..."; etc. But the one form is closer to one kind of verification, the other closer to another.

Page 358

How can you say that "... 625 ..." and "... 25×25 ..." say the same thing?--Only through our arithmetic do they *become one*.

Page 358

I can at one time arrive at the one, and at another time at the other kind of description, e.g. by counting. That is to say, I can arrive at either of these forms in either way; but by different routes.

Page 358

It might now be asked: if the proposition "... 625..." was verified at one time in this way and at another time in a different way, then did it mean the same thing both times?

Or: what happens if one method of verification gives '625', but the other not ' 25×25 '?--Is "... 625..." true and "... 25 times 25..." false? No.--To doubt the one means to doubt the other: that is the grammar given to these signs by our arithmetic.

Page 358

If both ways of counting are supposed to justify *giving a number* then giving *one* number, even though in different forms, is all that is *provided for*. On the other hand there is no contradiction in saying: "By one method of counting I get 25×25 (and so 625), by the other not 625 (and so not 25×25)". Arithmetic has no objection to this.

For arithmetic to equate the two expressions is, one might say, a grammatical trick.

In this way arithmetic bars a particular kind of description and conducts description into other channels. (And it goes without saying that this is connected with the facts of experience.)

4. Suppose I have taught somebody to multiply; not, however, by using an explicit general rule, but only by his seeing how I work out examples for him. I can then set him a *new* question and say: "Do the same with *these* two numbers as I did with the previous ones". But I can also say: "If you do with these two what I did with the others, then you will arrive at the number...". What kind of proposition is that?

"You will write such-and-such" is a prediction. 'If you write such-and-such, then you will have done it as I shewed you' determines what he calls "following his example".

'The solution to this problem is...!--If I read this before I have worked out the sum,--what sort of proposition is it?

"If you do with these numbers what I did with the others, you will get..."--that surely means: "The result of this calculation is..."--and that is not a prediction but a mathematical proposition. But it is none the less a prediction too--A prediction of a special kind. Just as someone who at the end finds that he really does get such-and-such when he adds up the column may be really surprised; for example may exclaim: Good Lord, it does come out!

Just think of this procedure of prediction and confirmation as a

special language-game--I mean: isolated from the rest of arithmetic and its application.

What is so singular about this game of prediction? What strikes me as singular would disappear if the prediction ran: "If you believe that you have gone by my example, then you will have produced *this*" or: "If everything seems correct to you, *this* will be the result". This game could be imagined in connexion with the administration of a particular poison and the prediction would be that the injection affects our faculties, our memory for example, in such-and-such a way.--But if we can imagine the game with the administration of a poison, then why not with the administration of a medicine? But even then the weight of the prediction may still always rest on the fact that the *healthy* man sees *this* as the result. Or perhaps: that *this* satisfies the healthy man.

"Do as I do, and this is what you will get" doesn't of course mean: "If you do as I do then you will do as I do"--nor: "Calculate like *this*, and you will calculate like *this*".--But what does "Do as I do" mean? In the language game--it can simply be an order: "Now do as I do!"

What is the difference between these predictions: "If you calculate correctly you will get *this* result"--and: "If you believe you are calculating correctly you will get *this* result"?

Now who says that the prediction in my language-game above does not mean the latter? It seems not to--but what *shews* this? Ask yourself *in what circumstances* the prediction would seem to predict the one thing and in what circumstances the other. For it is clear that it all depends on the rest of the circumstances.

If you predict that I shall get *this*, are you not simply predicting that I shall take this result as correct?--"But"--perhaps you say--"only because it really *is* correct!"--But what does it mean to say: "I take the calculation as correct because it is correct"?

And yet we can say: the person who is calculating in my language-game does not think of it as a peculiarity of *his* nature that he gets *this*; the fact does not appear to him as a psychological one.

I am imagining him as under the impression that he has only followed a thread that is already there, and accepting the How of the following as something that is a matter of course; and only knowing *one* explanation of his action, namely: how the thread runs.

He does just let himself go on when he follows the rule or the examples; however, he does not regard what

he does as a peculiarity of *his* course; he says, not: "so *that's* how I went", but: "so *that's* how it goes".

Page 361

But now, suppose someone did say at the end of the calculation in our language-game: "so *that's* how I went"--or: "so *this* course satisfies me"--can I say he has misunderstood the whole language-game? Certainly not! So long as he does not make some further unwelcome application of it.

Page 361

5. Isn't it the *application* that elicits that conception: that it is not we, but the calculation, that takes a certain course?

Page Break 362

Page 362

The different 'conceptions' must correspond to different applications.

Page 362

For there is indeed a distinction between these two things: being surprised that the figures on the paper seem to behave like *this*; and being surprised that *this* is what comes out as the result. In each case, however, I see the calculation in a different context.

Page 362

I think of the feeling of its 'coming out' when for instance we add up a rather long column of numbers of various patterns, and a round number of 1,000,000 comes out, as we had been told it would before, "Yes, by Jove, another nought--" we say.

Page 362

"One wouldn't guess it from looking at the numbers", I might say.

Page 362

How would it be if we said--instead of ' 6×6 gives 36':--'The number 36's being given by 6×6 '?--Replacing the *proposition* by a substantival expression. (The proof shews *the being given*.)

Page 362

Why do you always want to look at mathematics under the aspect of finding and not of doing?

Page 362

It must have a great influence, that we use the words "right" and "true" and "wrong" and the form of statement, in calculating. (Head-shaking and nodding.)

Page Break 363

Page 363

Why should I say that the knowledge that *this* is the way in which all human beings who have learned to calculate do calculate isn't *mathematical* knowledge? Because it seems to point in the direction of a different context.

Page 363

Then is working out what someone will get out by a calculation already applied mathematics?--and hence also: working out what I myself get out?

Page 363

6. There is no doubt at all that *in certain language-games* mathematical propositions play the part of rules of description, as opposed to descriptive propositions.

Page 363

But that is not to say that this contrast does not shade off in all directions. And *that* in turn is not to say that the contrast is not of the greatest importance.

Page 363

We feel that mathematics stands on a pedestal--this pedestal it has because of a particular role that its propositions play in our language games.

Page 363

What is proved by a mathematical proof is set up as an internal relation and withdrawn from doubt.

Page Break 364

Page 364

7. What is common to a mathematical proposition and a mathematical proof, that they are both called "mathematical"?

Not, that the mathematical proposition has to be proved mathematically; not, that the mathematical proof has to prove a mathematical proposition.

What is mathematical about an unproved proposition (an axiom)? what has it in common with a mathematical *proof*?

Page 364

Should I answer: "The inference rules of mathematical proof are always mathematical propositions"? Or: "Mathematical propositions and proofs are used in inference"? That would be getting closer to the truth.

Page 364

8. Proof must shew an internal relation, not an external one. For we might also imagine a process of transforming a sentence by *experiment*, and a transformation which would be used to predict what would be asserted by the transformed sentence. One might imagine, e.g., signs getting shifted through adding other signs to them, in such fashion that they form a true prediction on the basis of the conditions expressed in their initial position. And if you like, you may regard the calculating human being as an apparatus for such an experiment.

For, that a human being *works out* the result, in the sense that he doesn't write down the result at once, but only after he has written down various other things--doesn't make him any the less a physical-chemical means of producing one sequence of signs from another.

Page Break 365

Page 365

Thus I should have to say: The proved proposition is not: that sequence of signs which the man who has received such-and-such schooling produces under such-and-such conditions.

Page 365

When we think of proving in that way, what we see in it changes entirely. The intermediate steps become an uninteresting by-product. (Like a rattle in the insides of the automatic machine before it discharges its wares for us.)

Page 365

9. We say that a proof is a picture. But this picture stands in need of ratification, and that we give it when we work over it.--

Page 365

True enough; but if it got ratification from one person, but not from another, and they could not *come to any understanding*--would what we had here be calculation?

So it is not the ratification by itself that makes it calculation but the agreement of ratifications.

Page 365

For another game could quite well be imagined, in which people were prompted by expressions (similar perhaps to general rules) to let sequences of signs come to them for particular practical purposes, i.e. *ad hoc*; and that this even proved to pay. And here the 'calculations' if we choose to call them that, do not have to agree with one another. (Here we might speak of 'intuition'.)

Page 365

The agreement of ratifications is the pre-condition of our language-game, it is not affirmed in it.

Page Break 366

Page 366

If a calculation is an experiment and the *conditions are fulfilled*, then we must accept whatever comes, as the result; and if a calculation is an experiment then the proposition that it yields such and such a result is after all the proposition that under such conditions this kind of sign makes its appearance. And if under these conditions one result appears at one time and another at another, we have no right to say "there's something wrong here" or "both calculations cannot be all right", but we should have to say: this calculation does not always yield the same result (*why* need not be known). But although the procedure is now just as interesting, perhaps even more interesting, what we have here now is no longer calculation. And this is of course a grammatical remark about the use of the word "calculation". And this grammar has of course a point.

Page 366

What does it mean to reach an *understanding* about a difference in the result of a calculation? It surely means to arrive at a calculation that is free of discrepancy. And if we can't reach an understanding, then the one cannot say that the other is calculating too, only with different results.

Page 366

10. Now how about this--ought I to say that the same sense can only have *one* proof? Or that when a proof is found the sense alters?

Of course some people would oppose this and say: "Then the proof of a proposition cannot ever be found, for, if it has been found, it is no longer the proof of *this* proposition". But to say this is so far to say nothing at all.--

Page 366

It all depends *what* settles the sense of a proposition, what we choose

Page Break 367

to say settles its sense. The use of the signs must settle it; but what do we count as the use?--

Page 367

That these proofs prove the same proposition means, e.g.: both demonstrate it as a suitable instrument for the same purpose.

Page 367

And the purpose is an allusion to something outside mathematics.

Page 367

I once said: 'If you want to know what a mathematical proposition says, look at what its proof proves'.†1 Now is there not both truth and falsehood in this? For is the sense, the point, of a mathematical proposition really clear as soon as we can follow the proof?

Page 367

What Russell's ' $\sim f(f)$ ' lacks above all is application, and hence meaning.

If we do apply this form, however, that is not to say that ' $f(f)$ ' need be a proposition in any ordinary sense or ' $f(\xi)$ ' a propositional function. For the concept of a proposition, apart from that of a proposition of logic, is only explained in Russell in its general conventional features.

Here one is looking at language without looking at the language-game.

Page 367

When we say of different sequences of configuration that they shew e.g. that $25 \times 25 = 625$, it is easy enough to recognize what fixes the

Page Break 368

place of this proposition, which is reached by the two routes.

Page 368

A new proof gives the proposition a place in a new system; here there is often a translation of one kind of operation into a quite different kind. As when we translate equations into curves. And then we realize something about curves and, by means of that, about equations. But what right have we to be convinced by lines of thought which are apparently quite remote from the object of our thought?

Well, our operations are not more remote from that object than is, say, dividing in the decimal system from sharing out nuts. Especially if one imagines (what is quite easy to imagine) that operation as originally invented for a different purpose from that of making divisions and the like.

Page 368

If you ask: "What right have we?" the answer is: perhaps none.--What right have you to say that the development of this system will always run parallel with that one? (It is as if you were to fix *both* inch and foot as units, and assert that $12n$ inches will always be the same length as n feet.)

Page 368

When two proofs prove the same proposition it is possible to imagine circumstances in which the whole surrounding connecting these proofs fell away, so that they stood naked and alone, and there were no cause to say that they had a common point, proved the same proposition.

One has only to imagine the proofs without the organism of applications which envelopes and connects the two of them: as it were stark naked. (Like two bones separated from the surrounding manifold

Page Break 369

context of the organism; in which alone we are accustomed to think of them.)

Page 369

11. Suppose that people calculated with numbers, and sometimes did divisions by expressions of the form ($n - n$), and in this way occasionally got results different from the normal results of multiplying etc. But that nobody minded this.--Compare with this: lists, rolls, of people are prepared, but not alphabetically as we do it; and in this way it happens that in some lists the same name appears more than once.--But now it can be supposed that this does not strike anyone; or that people see it, but accept it without worrying. As we could imagine people of a tribe who, when they dropped coins on the ground, did not think it worth while to pick them up. (They have, say, an idiom for these occasions: "It belongs to the others" or the like.)

Page 369

But now times have changed and people (at first only a few) begin to demand exactness. Rightly,

wrongly?--Were the earlier lists *not* really lists?--

Page 369

Say we quite often arrived at the results of our calculations through a hidden contradiction. Does that make them illegitimate?--But suppose that we now absolutely refuse to accept such results, but still are afraid that some might slip through.--Well then, in that case we have an idea which might serve as a model for a new calculus. As one can have the idea of a new game.

Page Break 370

Page 370

The Russellian contradiction is disquieting, not because it is a contradiction, but because the whole growth culminating in it is a cancerous growth, seeming to have grown out of the normal body aimlessly and senselessly.

Page 370

Now can we say: "We want a calculus which more certainly tells us the truth"?

Page 370

But you can't allow a contradiction to stand!--Why not? We do sometimes use this form in our talk, of course not often--but one could imagine a technique of language in which it was a regular instrument.

It might for example be said of an object in motion that it existed and did not exist in this place; change might be expressed by means of contradiction.

Page 370

Take a theme like that of Haydn's (St. Antony Chorale), take the part of one of Brahms's variations corresponding to the first part of the theme, and set the task of constructing the second part of the variation in the style of its first part. That is a problem of the same kind as mathematical problems are. If the solution is found, say as Brahms gives it, then one has no doubt;--that is the solution.

Page 370

We are agreed on this route. And yet, it is obvious here that there may easily be different routes, on each of which we can be in agreement, each of which we might call consistent.

Page Break 371

Page 371

'We take a number of steps, all legitimate--i.e. allowed by the rules--and suddenly a contradiction results. So the list of rules, as it is, is of no use, for the contradiction wrecks the whole game!' Why do you have it wreck the game?

But what I want is that one should be able to go on inferring *mechanically* according to the rule without reaching any contradictory results. Now, what kind of provision do you want? One that your present calculus does not allow? Well, that does not make that calculus a bad piece of mathematics,--or not mathematics in the fullest sense. The meaning of the word "mechanical" misleads you.

Page 371

12. When, for some practical purpose, you want to avoid a contradiction mechanically, as your calculus so far cannot do, this is e.g. like looking for a construction of the ...-gon, which you have up to now only been able to draw by trial and error; or for a solution of a third degree equation, to which you have so far only approximated.

Page 371

What is done here is not to improve bad mathematics, but to create a new bit of mathematics.

Suppose I wanted to determine that the pattern '777' did not occur in the expansion of an irrational number. I might take π and settle that if that pattern occurs, we replace it by '000'. Now I am told: that is not enough, for whoever is calculating the places is prevented from looking back to the earlier ones. Now I need another calculus; one in which I can be assured in advance that it cannot yield '777'. A mathematical problem.

Page Break 372

Page 372

'So long as freedom from contradiction has not been proved I can never be quite certain that someone who calculates without thinking, but according to the rules, won't work out something wrong.' Thus so long as this provision has not been obtained the calculus is untrustworthy.--But suppose that I were to ask: "*How* untrustworthy?"--If we spoke of degrees of untrustworthiness mightn't this help us to take the metaphysical sting out of it?

Were the first rules of the calculus not good? Well, we gave them only *because* they were good.--If a contradiction results later,--have they *failed* in their office? No, they were not given for this application.

Page 372

I may want to supply my calculus with a particular kind of provision. This does not make it into a *proper* piece of mathematics, but e.g. into one that is more useful for a certain purpose.

Page 372

The idea of the mechanization of mathematics. The fashion of the axiomatic system.

Page 372

13. But suppose the 'axioms' and 'methods of inference' are not just some kind of construction, but are absolutely convincing. Well, this means that there are cases in which a construction out of these elements is *not* convincing.

And the logical axioms are in fact not at all convincing if for the propositional variables we substitute structures which no one originally foresaw as possible values, when, that is, we began by acknowledging the truth of the axioms absolutely.

Page Break 373

Page 373

But what about saying: the axioms and methods of inference surely ought to be so chosen that they cannot prove any false proposition?

Page 373

'We want, not just a fairly trustworthy, but an *absolutely* trustworthy calculus. Mathematics must be *absolute*.'

Page 373

Suppose I had erected rules for a game of 'hare and hounds'--fancying it to be a nice amusing game.--Later, however, I find that the hounds can always win once one knows how.

Now, let's say, I am dissatisfied with my game. The rules which I gave brought forth a result which I did not foresee and which spoils the game for me.

Page 373

14. "N. came upon the fact that in their calculations people had often reduced by expressions of the form ' $n - n$ '. He pointed out the consequent discrepancy of results and shewed how this way of calculating had led to the loss of human life."

Page 373

But let us suppose that other people too had noticed these contradictions, only they had not been able to give any account of their source. They calculated as it were with a bad conscience. They had chosen *one* among contradictory results but with uncertainty, whereas N's discovery would have made them quite certain.--But did they tell themselves: "There's something wrong with our calculus"? Was their uncertainty of the same kind as ours when we do a physical calculation

Page Break 374

but are not certain whether these formulae really give the correct result here? Or was it a doubt whether their calculating was really calculating? In this case: what did they do to get over the difficulty?

Page 374

So far these people have only rarely made use of reduction by expressions of values. But some time somebody discovers that they can actually arrive at any arbitrary result in this way.--What do they do now? Well, we could imagine very different things. They may now, e.g., state that this kind of calculation has lost its point, and that in future people are not to calculate in *this* way any more.

Page 374

'He believes that he is calculating'--one would like to say--'but as a matter of fact he is not calculating.'

Page 374

15. If the calculation lost its point for me as soon as I knew I could work out any arbitrary result--did it have none so long as I did *not* know that?

Page 374

I may of course now declare all these calculations to be null--for I have given up doing them now--but does that mean that they weren't calculations?

Page 374

I at one time inferred *via* a contradiction without realizing it. Is my result then wrong, or at any rate wrongly got?

Page Break 375

Page 375

If the contradiction is so well hidden that no one notices it, why shouldn't we call what we do now proper calculation?

Page 375

We say that the contradiction would *destroy* the calculus. But suppose it only occurred in tiny doses in lightning flashes as it were, not as a constant instrument of calculation, would it nullify the calculus?

Page 375

Imagine people had fancied that $(a + b)^2$ must be equal to $a^2 + b^2$. (Is this a fancy of the same kind as that there must be a trisection of the angle by ruler and compass?) Is it possible, then, to fancy that two ways of calculating had to yield the same result, if it is not the same?

Page 375

I add up a column, doing it in a variety of ways (e.g. I take the numbers in a different order), and I keep on getting random different results.--I shall perhaps say: "I am in a complete muddle, either I am making random mistakes in calculating, or I am making certain mistakes in particular connexions: e.g. always saying '7 + 7 = 15' after '6 + 3 = 9'."

Or I might imagine that suddenly, once in the sum, I subtract instead of adding, but don't think I am doing anything different.

Page 375

Now it might be that I didn't find the mistake and thought I had lost my wits. But this would not have to be my reaction.

Page Break 376

Page 376

'Contradiction destroys the calculus'--what gives it this special position? With a little imagination, I believe, it can certainly be shaken.

Page 376

To resolve these philosophical problems one has to compare things which it has never seriously occurred to anyone to compare.

Page 376

In this field one can ask all sorts of things which, while they belong to the topic, still do not lead through its centre.

A particular series of questions leads through the centre and out into the open. The rest get answered incidentally.

It is enormously difficult to find the path through the centre.

Page 376

It goes *via new* examples and comparisons. The hackneyed ones don't shew us it.

Page 376

Let us suppose that the Russellian contradiction had never been found. Now--is it quite clear that in that case we should have possessed a false calculus? For aren't there various possibilities here?

Page 376

And suppose the contradiction had been discovered but we were not excited about it, and had settled e.g. that no conclusions were to be drawn from it. (As no one does draw conclusions from the 'Liar'.) Would this have been an obvious mistake?

Page Break 377

Page 377

"But in that case it isn't a proper calculus! It loses all *strictness*!" Well, not *all*. And it is only lacking in full strictness, if one has a particular ideal of rigour, wants a particular style in mathematics.

'But a contradiction in mathematics is incompatible with its application.

Page 377

'If it is consistently applied, i.e. applied to produce arbitrary results, it makes the application of mathematics into a farce, or some kind of superfluous ceremony. Its effect is e.g. that of non-rigid rulers which permit various results of measuring by being expanded and contracted.' But was measuring by pacing not measuring at all? And if people worked with rulers made of dough, would that of itself have to be called wrong?

Page 377

Couldn't reasons be easily imagined, on account of which a certain elasticity in rulers might be desirable?

Page 377

"But isn't it right to manufacture rulers out of ever harder, more unalterable material?" Certainly it is right; if

that is what one wants!

Page 377

'Then are you in favour of contradiction?' Not at all; any more than of soft rulers.

Page 377

There is *one* mistake to avoid: one thinks that a contradiction *must* be senseless: that is to say, if e.g. we use the signs ' p ', ' \sim ', ' $'$ ' consistently,

Page Break 378

then ' $p.\sim p$ ' cannot say anything.--But think: what does it mean to continue such and such a use 'consistently'? ('A consistent continuation of this bit of a curve.')

Page 378

16. What does mathematics need a foundation for? It no more needs one, I believe, than propositions about physical objects--or about sense impressions, need an *analysis*. What mathematical propositions do stand in need of is a clarification of their grammar, just as do those other propositions.

Page 378

The *mathematical* problems of what is called foundations are no more the foundation of mathematics for us than the painted rock is the support of a painted tower.

Page 378

'But didn't the contradiction make Frege's logic useless for giving a foundation to arithmetic?' Yes, it did. But then, who said that it had to be useful for this purpose?

Page 378

One could even imagine a savage's having been given Frege's logic as an instrument with which to derive arithmetical propositions. He derived the contradiction unawares, and now he derives arbitrary true and false propositions from it.

Page 378

'Up to now a good angel has preserved us from going *this* way.' Well, what more do you want? One might say, I believe: a good angel will always be necessary, whatever you do.

Page Break 379

Page 379

17. One says that calculation is an experiment, in order to shew how it is that it can be so practical. For we do know that an experiment really does have practical value. Only one forgets that it possesses this value in virtue of a technique which is a fact of natural history, but whose rules do not play the part of propositions of natural history.

Page 379

"The limits of empiricism."†1--(Do we live because it is practical to live? Do we think because thinking is practical?)

Page 379

He knows that an experiment is practical; and so calculation is an experiment.

Page 379

Our experimental activities have indeed a characteristic physiognomy. If I see somebody in a laboratory pouring a liquid into a test tube and heating it over a Bunsen burner, I am inclined to say he is making an experiment.

Page 379

Let us suppose that people, who know how to count, want--just as we do--to know numbers for practical purposes of various kinds. And to this end they ask certain people who, having had the practical problem explained to them, shut their eyes, and let the appropriate number occur to them--here there wouldn't be any calculation, however trustworthy the numbers given might be. This way of determining numbers might be even more trustworthy in practice than any calculation.

Page Break 380

Page 380

A calculation--it might be said--is perhaps a part of the technique of an experiment, but is by itself not an experiment.

Page 380

Do we forget that a particular *application* is part of a procedure's being an experiment? And the calculation is an instrument of the application.

For would anyone *think* of calling the translation of a cipher by means of a key an experiment?

When I doubt whether n and m multiplied yield l , my doubt isn't about whether our calculating is going to fall into confusion, and e.g. half of mankind say one thing is right and the other half another.

An action is an 'experiment' only as seen from a certain point of view. And it is *obvious* that the action of calculating can also be an experiment.

I may for example want to test what this man calculates, in such-and-such circumstances, when set this question.--But isn't that exactly what you are asking when you want to know what 52×63 is? I may very well ask that--my question may even be expressed in these words. (Compare: is the sentence "Listen, she's groaning!" a proposition about her behaviour or about her suffering?)

But suppose I *work over* his calculation?--'Well, then I am making a further experiment so as to find out with complete certainty that all normal human beings react like that.'--And if they do *not* react uniformly--which one is the mathematical result?

18. "If calculation is to be practical, then it must uncover facts. And only experiment can do that."

But what things are 'facts'? Do you believe that you can shew what fact is meant by, e.g., pointing to it with your finger? Does that of itself clarify the part played by 'establishing' a fact?--Suppose it takes mathematics to define the *character* of what you are calling a 'fact'!

It is interesting to know *how many* vibrations this note has! But it took arithmetic to teach you this question. It taught you to see this kind of fact.

Mathematics--I want to say--teaches you, not just the answer to a question, but a whole language-game with questions and answers.

Are we to say that *mathematics* teaches us to count?

Can mathematics be said to teach us experimental *methods of investigation*? Or to help us to discover such methods of investigation?

'To be practical, mathematics must tell us facts.'--But do these facts have to be the *mathematical* facts?--But why should not mathematics, instead of 'teaching us facts', create the forms of what we call facts?

"Yes but surely it remains an empirical fact that men calculate like this!"--Yes, but that does not make the propositions used in calculating into empirical propositions.

"Yes, but surely our calculating must be founded on empirical facts!" Certainly. But what empirical facts are you now thinking of? The psychological and physiological ones that make it possible, or those that make it a useful activity? The connexion with *the latter* consists in the fact that the calculation is the picture of an experiment as it practically always turns out. From the former it gets its point, its physiognomy; but that is certainly not to say that the propositions of mathematics have the functions of empirical propositions. (That would almost be as if someone were to believe that because only the actors appear in the play, no other people could usefully be employed upon the stage of the theatre.)

There are no causal connexions in a calculation, only the connexions of the pattern. And it makes no difference to this that we work over the proof in order to accept it. That we are therefore tempted to say that it arose as the result of a psychological experiment. For the psychical course of events is not psychologically investigated when we calculate.

'There are 60 seconds to a minute.' This proposition is very *like* a mathematical one. Does its truth depend on experience?--Well, could we talk about minutes and hours, if we had no sense of time; if there were no clocks, or could be none for physical reasons; if there did not exist all the connexions that give our measures of time meaning and importance? In that case--we should say--the measure of time would have lost its meaning (like the action of

delivering check-mate if the game of chess were to disappear)--or it would have some quite different meaning. But suppose our experience were like that--then would experience make the proposition false; and the contrary experience make it true? No; *that* would not describe its function. It functions quite differently.

Page Break 383

Page 383

'Calculating, if it is to be practical, must be grounded in empirical facts.'--Why should it not rather determine what empirical facts *are*?

Page 383

Consider: 'Our mathematics turns experiments into definitions'.

Page 383

19. But can't we imagine a human society in which calculating quite in our sense does not exist, any more than measuring quite in our sense?--Yes.--But then why do I want to take the trouble to work out what mathematics is?

Because we have a mathematics, and a special conception of it, as it were an ideal of its position and function,--and this needs to be clearly worked out.

Page 383

Don't demand too much, and don't be afraid that your just demand will dwindle into nothing.

Page 383

It is my task, not to attack Russell's logic from within, but from without.

Page 383

That is to say: not to attack it mathematically--otherwise I should be doing mathematics--but its position, its office.

Page 383

My task is, not to talk about (e.g.) Gödel's proof, but to by-pass it.

Page Break 384

Page 384

20. The problem: find the number of ways in which we can trace the joins in this wall:

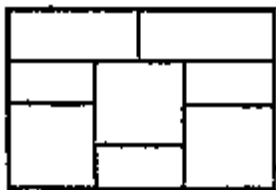

continuously and without repetition, will be recognized by everyone as a *mathematical* problem.--If the drawing were much bigger and more complicated, and could not be taken in at a glance, it could be supposed to change without our noticing; and then the problem of finding that number (which perhaps changes according to some law) would no longer be a mathematical one. But even if it does not change, the problem is, in this case, still not mathematical.--But even when the wall can be taken in at a glance, that cannot be said to make the question mathematical, as when we say: *this* question is now a question in embryology. Rather: *here* we need a mathematical solution. (Like: here what we need is a *model*.)

Page 384

Did we 'recognize' the problem as a mathematical one because mathematics treats of making tracings from drawings?

Page 384

Why, then, are we inclined to call this problem straight away a 'mathematical' one? Because we see at once that here the answer to a *mathematical* question is *practically* all we need. Although the problem could easily be seen as, for example, a psychological one.

Similarly with the task of folding a piece of paper in such-and-such a way.

Page Break 385

Page 385

It may look as if mathematics were here a science that makes experiments with *units*; experiments, that is, in which it does not matter what kind of units they are, whether for instance they are peas, glass marbles, strokes and so on.--Mathematics discovers only what holds for *all* these things. And so it does not discover anything about e.g. their melting point, but that 2 and 2 of them are 4. And the first problem of the wall is a mathematical one, i.e. can be

solved by means of *this* kind of experiment.--And what does the mathematical experiment consist in? Well, in setting things out and moving them about, in drawing lines, writing down expressions, propositions, etc. And we must not be disturbed by the fact that the outward appearance of these experiments is not that of physical or chemical experiments, etc.; they just are of a different kind. Only there is a difficulty here: the procedure is easy enough to see, to describe,--but *how* is it to be looked at as an experiment? What is the head and what the tail of the experiment here? What are the conditions of the experiment, what its result? Is the result what is yielded by the calculation; or the pattern of calculation; or the assent (whatever that consists in) of the person doing the calculation?

Page 385

But does it make the principles of dynamics, say, into propositions of pure mathematics if we leave their interpretation open, and then use them to produce a system of measurement?

Page 385

'A mathematical proof must be perspicuous'--this is connected with the perspicuousness of that figure.

Page 385

21. Do not forget that the proposition asserting of itself that it is unprovable is to be conceived as a *mathematical* assertion--for that is not *a matter of course*.

It is not a matter of course that the proposition that such-and-such

Page Break 386

a structure cannot be constructed is to be conceived as a mathematical proposition.

Page 386

That is to say: when we said: "it asserts of itself"--this has to be understood in a special way. For here it is easy for confusion to occur through the variegated use of the expression "this proposition asserts something of...".

Page 386

In this sense the proposition ' $625 = 25 \times 25$ ' also asserts something about itself: namely that the left-hand number is got by the multiplication of the numbers on the right.

Page 386

Gödel's proposition, which asserts something about itself, does not *mention* itself.

Page 386

'The proposition says that this number cannot be got from these numbers in this way.'--But are you also certain that you have translated it correctly into English? Certainly it looks as if you had.--But isn't it possible to go wrong here?

Page 386

Could it be said: Gödel says that one must also be able to trust a mathematical proof when one wants to conceive it practically, as the proof that the propositional pattern can be constructed according to the rules of proof?

Or: a mathematical proposition must be capable of being conceived as a proposition of a geometry which is actually applicable to itself. And if one does this it comes out that in certain cases it is not possible to rely on a proof.

Page Break 387

Page 387

The limits of empiricism†1 are not assumptions unguaranteed, or intuitively known to be correct: they are ways in which we make comparisons and in which we act.

Page 387

22. 'Let us assume that we have an arithmetical proposition saying that a particular number... cannot be obtained from the numbers ..., ..., ..., by means of such and such operations. And let us assume that a rule of translation can be given according to which this arithmetical proposition is translatable into the figures of the first number--the axioms from which we are trying to prove it, into the figures of the other numbers--and our rules of inference into the operations mentioned in the proposition.--If we had then derived *the arithmetical proposition* from the axioms according to our rules of inference, then *by this means* we should have demonstrated its derivability, but we should also have proved a proposition which, by that translation rule, can be expressed: this arithmetical proposition (namely ours) is not derivable.'

What would have to be done here? I am supposing that we trust our *construction* of the *propositional sign*; i.e. we trust the *geometrical* proof. So we say that this 'propositional pattern' can be obtained from those in such and such ways. And, merely translated into another notation, this means: this number can be got from those by means of these operations. So far the proposition and its proof have nothing to do with any special *logic*. Here the constructed proposition was simply another way of writing the constructed number; it had the *form* of a proposition but we don't compare it with other propositions as a sign *saying* this or that, making *sense*.

Page 387

But it must of course be said that that sign need not be regarded either as a propositional sign or as a number sign.--Ask yourself: what makes it into the one, and what into the other?

Page Break 388

Page 388

If we now read the constructed proposition (or the figures) as a proposition of mathematical language (in English, say) then it says the opposite of what we regard as proved. Thus we have demonstrated the falsity of the real sense of the proposition and at the same time *proved* it--if, that is, we look on its construction from the admitted axioms by means of the admitted rules of inference as a proof.

Page 388

If someone objects to us that we couldn't make such *assumptions*, for they would be *logical* or *mathematical* assumptions, then we reply that we need only assume that someone has made a mistake in calculating and so has reached the result we 'assume', and that for the time being he cannot find the mistake.

Page 388

Here once more we come back to the expression "the proof convinces us". And what interests us about conviction here is neither its expression by voice or gesture, nor yet the feeling of satisfaction or anything of that kind; but its ratification in the use of what is proved.

Page 388

It might justly be asked what importance Gödel's proof has for our work. For a piece of mathematics cannot solve problems of the sort that trouble *us*.--The answer is that the *situation*, into which such a proof brings us, is of interest to us. 'What are we to say now?'--That is our theme.

Page 388

However queer it sounds, my task as far as concerns Gödel's proof seems merely to consist in making clear what such a proposition as:

Page Break 389

Page 389

"Suppose this could be proved" means in mathematics.

Page 389

23. We take it much too much for granted that we ask "How many?" and thereupon count and calculate.

Page 389

Do we count because it is practical to count? We count!--And in the same way we calculate.

Page 389

An experiment--or whatever one likes to call it--can be what we go on, sometimes in determining the measurement of the thing measured, and sometimes even in determining the appropriate measure.

Page 389

Then is the unit of measurement in this way the result of measurements? Yes and no. Not the result reached in measuring but perhaps the *consequence* of measurements.

Page 389

"Has experience taught us to calculate in *this* way?" would be one question and: "Is calculation an experiment?" another.

Page 389

24. But isn't it possible to derive anything from anything according to some rule or other--nay, according to *any* rule with a suitable interpretation? What does it mean for me to say, for example: this number can be got from that pair of numbers by multiplying? Ask yourself: When does one use this proposition? Well, it isn't, e.g., a psychological proposition saying what humans will do under certain conditions;

Page Break 390

what will satisfy them; nor is it a physical proposition concerning the behaviour of marks on paper. That is, it will be applied in a surrounding other than a psychological or physical one.

Page 390

Assume that human beings learn to calculate, roughly as they in fact do; but now imagine different 'surroundings' which turn the calculating, now into a psychological experiment, now into a physical experiment with the marks used in calculating, now into something else!

We assume that children learn counting and the simple kinds of sum by means of imitation, encouragement and correction. But now, from a certain point of view, the nonagreement of the one who is doing the sums (i.e., the

mistakes) get treated, not as something bad, but as something psychologically interesting. "So you took that for correct then, did you? The rest of us did it like *this*."

Page 390

I want to say that what we call mathematics, the *mathematical* conception of the proposition $13 \times 14 = 182$, hangs together with the special position that we assign to the activity of calculating. Or, the special position that the calculation... has in our life, in the rest of our activities. The language-game in which it is found.

Page 390

One may learn a piece of music by heart in order to be able to play it correctly; but also as part of a psychological experiment, in order to investigate the working of musical memory. But one might also impress it on one's memory in order thereby to judge some alterations in the score.

Page Break 391

Page 391

25. A language-game: I am doing multiplication and I say to the other: if you calculate right you will get such-and-such a result; whereupon he carries out the calculation and is pleased at the correctness, and sometimes the incorrectness, of my prediction. What does this language-game presuppose? That 'mistakes in calculating' are easy to discover, and that agreement about the rightness or wrongness of the calculation is always quickly achieved.

Page 391

"If you agree with each step, you will arrive at this result."

Page 391

What is the criterion for a step in the calculation's being right; isn't it that the step seems right to me, and other things of the same sort?

What is the criterion for my working out the same figure twice? Isn't it things like the figures' *appearing* to me to be the same?

Page 391

What is the criterion for my having followed the paradigm here?

Page 391

"If you say that each step is correct, this is what will come out."

Page 391

The prediction really is: where you hold what you do to be right, *this* is what you will do.

Where you hold each step to be right, you will go this way.--And so you will reach this end.

Page Break 392

Page 392

A *logical* conclusion is being drawn, when no experience can contradict the conclusion without contradicting the premises. I.e., when the inference is only a movement within the means of representation.

Page 392

26. In some language-game sentences are used; reports, orders and so on. And now the people also employ calculating propositions. They say them to themselves perhaps, in between the orders and the reports.

Page 392

A language-game, in which someone calculates according to a rule and places the blocks of a building according to the results of the calculation. He has learnt to operate with written signs according to rules.--Once you have described the procedure of this teaching and learning, you have said everything that can be said about acting correctly according to a rule. We can go no further. It is no use, for example, to go back to the concept of agreement, because it is no more certain that one proceeding is in agreement with another, than that it has happened in accordance with a rule. Admittedly going according to a rule is also founded on an agreement.

Page 392

To repeat, what the correct following of a rule consists in cannot be described *more closely* than by describing the *learning* of 'proceeding according to the rule.' And this description is an everyday one, like that of cooking and sewing, for example. It presupposes as much as these. It distinguishes one thing from another, and so it informs a human being who is ignorant of something particular. (Cf. the remark: Philosophy doesn't use a preparatory language, etc.)

Page Break 393

Page 393

For if you give me a description of how people are trained in following a rule and how they react correctly to the training, you will yourself employ the expression of a rule in the description and will presuppose that I

understand it.

Page 393

We have, then, taught someone the technique of multiplying. So we employ expressions of acquiescence and rejection. We shall also sometimes write down the goal of the multiplication: "You must get this, if it is to be right," we may say to him.

Page 393

But now, can the pupil contradict and say: "How do you know that? And what do you want?--Do you want me to follow the rule, or to get this result? For there's no need for the two to coincide." Well, we do not assume that the pupil can say that; we assume that he accepts the rule as valid when approached from either side. That he conceives both the individual step *and* the multiplication-pattern--and therefore the result of the multiplication--as criteria of correctness, and if these are not in accord with one another, he believes there is some confusion of his senses.

Page 393

27. Now is it imaginable for someone to follow the rule right and nevertheless to work out different results at different times in multiplying 15×13 ? It all depends on what criteria one allows to count for correct following of the rule. In mathematics the result itself is also a criterion for correct calculation. Here then it is unthinkable that one should follow the rule right and should produce different patterns of multiplication.

Page Break 394

Page 394

Not letting a contradiction stand is something that characterises the technique of our employment of our truth-functions. If we do let the contradiction stand in our language-games, we alter that technique--as, if we departed from regarding a double negative as an affirmative. And this alteration would be significant, because the technique of our logic is connected in its character with the conception of the truth-functions.

Page 394

"The rules compel me to..."--this can be said if only for the reason that it is not all a matter of my own will what seems to me to agree with the rule. And that is why it can even happen that I memorize the rules of a board-game and subsequently find out that in this game whoever starts *must* win. And it is something like this, when I discover that the rules lead to a contradiction.

Page 394

I am now compelled to acknowledge that this is not a proper game.

Page 394

'The rules of multiplication, once adopted, compel me to acknowledge that $\dots \times \dots = \dots$.' Suppose it were disagreeable for me to acknowledge this proposition. Am I to say: "Well, this arises from that type of training. Human beings who are so trained, so conditioned, then get into this kind of difficulty"?

Page 394

'How does one count in the decimal system?'--"We write 2 after 1, 3 after 2, ... 14 after 13 ... 124 after 123 *and so on*."--That is an explanation for someone who, while there is indeed something he doesn't know, does understand 'and so on'. And understanding it

Page Break 395

means not understanding it as an abbreviation: it does *not* mean that he now sees a much longer series in his mind than that of my examples. That he understands it comes out in his now making certain applications, in his saying *this* and acting *so* in particular cases.

Page 395

"How do we count in the decimal system?"-- --Now is that not an answer?--But it isn't one for someone who did not understand the 'and so on'.--But may our explanation not have made it intelligible to him? May he not, through it, have got hold of the idea of the rule?--Ask yourself what are the criteria for his having got hold of the idea now.

Page 395

What is it that compels me?--the expression of the rule?--Yes, once I have been educated in this way. But can I say it compels me to follow it? Yes: if here one thinks of the rule, not as a line that I trace, but rather as a spell that holds us in thrall.

(("plain nonsense, and bumps..."))

Page 395

28. Why shouldn't it be said that such a contradiction as: 'heterological' \in heterological $\equiv \sim$ ('heterological' \in

heterological), shews a logical property of the concept 'heterological'?

Page 395

"'Two-syllabled' is heterological", or "'Four-syllabled' is not heterological" are empirical propositions. It might be important in some contexts to find out whether adjectives possess the properties they stand for or not. The word "heterological" would in that case

Page Break 396

be used in a language-game. But now, is the proposition "' $h \in h$ '" supposed to be an empirical proposition? It obviously is not one, nor should we admit it as a proposition in our language-game even if we had not discovered the contradiction.

Page 396

' $h \in h \equiv \sim (h \in h)$ ' might be called 'a true contradiction'.--But this contradiction is not a significant proposition! Agreed, but the tautologies of logic aren't either.

Page 396

"The contradiction is true" means: it is proved; derived from the rules for the word " h ". Its employment is, to shew that "' h '" is one of those words which do not yield a proposition when inserted into ' $\xi \in h$ '.

Page 396

"The contradiction is true" means: this really is a contradiction, and so you cannot use the word " h " as an argument in ' $\xi \in h$ '.

Page 396

29. I am defining a game and I say: "If you move like this, then I move like *this*, and if you do that, then I do *this*.--Now play." And now he makes a move, or something that I have to accept as a move and when I want to reply according to my rules, whatever I do proves to conflict with the rules. How can this have come about? When I set the rules up, I *said* something: I was following a certain use. I did not foresee what we should go on to do, or I saw only a particular possibility. It was just as if I had said to somebody: "Give up the game; you can't mate with these pieces" and had overlooked an existing possibility of mating.

Page Break 397

The various half joking guises of logical paradox are only of interest in so far as they remind anyone of the fact that a serious form of the paradox is indispensable if we are to understand its function properly. The question is: what part can such a logical mistake play in a language-game?

Page 397

You may instruct someone what to do in such-and-such a case; and these instructions later prove *nonsensical*.

Page 397

30. Logical inference is part of a language-game. And someone who carries out logical inferences in the language-game follows certain instructions which were given him in the actual learning of the language-game. If, say, a builder's mate is building a house in accordance with certain orders, he has to interrupt his cartage of materials etc. from time to time and carry out certain operations with signs on paper; and then he takes up his work again in conformity with the result.

Page 397

Imagine a procedure in which someone who is pushing a wheelbarrow comes to realize that he must clean the axle of the wheel when the wheelbarrow gets too difficult to push. I don't mean that he says to himself. "Whenever the wheelbarrow can't be pushed...", but he simply *acts* in this way. And he happens to shout to someone else: "The wheelbarrow won't push; clean the axle", or again: "The wheelbarrow won't push. So the axle needs cleaning." Now this is an inference. Not a logical one, of course.

Page Break 398

Page 398

Can I now say: "Non-logical inference can prove wrong; but logical inference not"?

Page 398

Is logical inference correct when it has been made according to rules; or when it is made according to *correct* rules? Would it be wrong, for example, if it were said that p should always be inferred from $\sim p$? But why should one not rather say: such a rule would not give the signs ' $\sim p$ ' and ' p ' their usual meaning?

Page 398

We can conceive the rules of inference--I want to say--as giving the signs their meaning, because they are

rules for the use of these signs. So that the rules of inference are involved in the determination of the meaning of the signs. In this sense rules of inference cannot be right or wrong.

Page 398

In the course of building A has measured the length and breadth of an area and gives B the order: "bring 15×18 slabs". B is trained to multiply and to count out a number of slabs in conformity with the result.†1

Page 398

The sentence ' $15 \times 18 = 270$ ' need of course never be uttered.

Page 398

It might be said: experiment--calculation are poles between which human activities move.

Page 398

31. We condition a man in such-and-such ways; then bring a question to bear on him; and get a number-sign. We go on to use

Page Break 399

this for our purposes and it proves practical. That is calculating.--No, it isn't enough! It might be an eminently *sensible* procedure--but need not be what we call 'calculating'. As one could imagine sounds being emitted for purposes now served by language, which sounds yet did not form a language.

It is essential to calculating that everyone who calculates right produces the same pattern of calculation. And 'calculating right' does not mean calculating with a clear understanding or smoothly; it means calculating *like this*.

Page 399

Every mathematical proof gives the mathematical edifice a new leg to stand on. (I was thinking of the legs of a table.)

Page 399

32. I have asked myself: if mathematics has a purely fanciful application, isn't it still mathematics?--But the question arises: don't we call it 'mathematics' only because e.g. there are transitions, bridges from the fanciful to non-fanciful applications? That is to say: should we say that people possessed a mathematics if they used calculating, operating with signs, *merely* for occult purposes?

Page 399

33. But in that case isn't it incorrect to say: the *essential* thing about mathematics is that it forms concepts?--For mathematics is after all an anthropological phenomenon. Thus we can recognize it as the essential thing about a great part of mathematics (of what is called 'mathematics') and yet say that it plays no part in other regions. This insight by itself will of course have some influence on people once they learn to see mathematics in this way. Mathematics is, then, a family; but that is not to say that we shall not mind what is incorporated into it.

Page Break 400

Page 400

We might say: if you did not understand *any* mathematical proposition better than you understand the Multiplicative Axiom,†1 then you would *not* understand mathematics.

Page 400

34. --There is a contradiction here. But we don't see it and we draw conclusions from it. E.g. we infer mathematical propositions; and wrong ones. But we accept these inferences.--And now if a bridge collapses, which we built on the basis of these calculations, we find some other cause for it, or we call it an Act of God. Now was our calculation wrong; or was it not a calculation?

Certainly, if we are explorers observing the people who do this we shall perhaps say: these people don't calculate at all. Or: there is an element of arbitrariness in their calculations, which distinguishes the nature of their mathematics from ours. And yet we should not be able to deny that these people have a mathematics.

Page 400

What kind of rules must the king†2 give so as to escape henceforward from the awkward position, which his prisoner has put him in?--What sort of problem is this?--It is surely like the following one: how must I change the rules of this game, so that such-and-such a situation cannot occur? And that is a mathematical problem.

Page 400

But can it be a mathematical problem to make mathematics into mathematics?

Page 400

Can one say: "After this mathematical problem was solved, human beings began really to calculate"?

35. What sort of certainty is it that is based on the fact that in general there *won't* actually be a run on the banks by all their customers; though they would break if it did happen?! Well, it is a *different* kind of certainty from the more primitive one, but it is a kind of certainty all the same.

I mean: if a contradiction were now actually found in arithmetic--that would only prove that an arithmetic with *such* a contradiction in it could render very good service; and it will be better for us to modify our concept of the certainty required, than to say that it would really not yet have been a proper arithmetic.

"But surely this isn't ideal certainty!"--Ideal for what purpose?

The rules of logical inference are rules of the *language-game*.

36. What *sort* of proposition is: "The class of lions is not a lion, but the class of classes is a class"? How is it verified? How could it be *used*?--So far as I can see, only as a grammatical proposition. To draw someone's attention to the fact that the word "lion" is used in a fundamentally different way from the name of a lion; whereas the class word "class" is used like the designation of one of the classes, say the class *lion*.

One may say that the word "class" is used reflexively, even if for instance one accepts Russell's theory of types. For it is used reflexively there too.

Of course to say in this sense that the class of lions is not a lion etc. is like saying one has taken an "e" for an "a" when one has taken a ball for a bell.

The sudden change of aspect in the picture of a cube and the impossibility of seeing 'lion' and 'class' as comparable concepts.

The contradiction says: "Look out....".

But suppose that one gives a particular lion (the king of lions) the name "Lion"? Now you will say: But it is clear that in the sentence "Lion is a lion" the word "lion" is being used in two different ways. (*Tractatus Logico-philosophicus*.†1) But can't I count them as *one* kind of use?

But if the sentence "Lion is a lion" is used in this way: shouldn't I be drawing your attention to anything, if I drew your attention to the difference of employment of the two "lion"s?

One can examine an animal to see if it is a cat. But at any rate the concept cat cannot be examined in this way.

Even though "the class of lions is not a lion" seems like nonsense,

to which one can only ascribe a sense out of politeness; still I do not want to take it like that, but as a proper sentence, if only it is taken right. (And so not as in the *Tractatus*.) Thus my conception is a different one here. Now this means that I am saying: there is a language-game with this sentence too.

"The class of cats is not a cat."--How do you know?

The fable says: "The lion went for a walk with the fox", not a lion with a fox; nor yet the lion so-and-so with the fox so-and-so. And here it actually is as if the species lion came to be seen as a lion. (It isn't as Lessing†1 says, as if a particular lion were put in the place of some lion or other. "Reynard the Fox" does not mean: a fox of the name "Reynard".)

Imagine a language in which the class of lions is called "the lion of all lions", the class of trees "the tree of all

trees", etc.--Because people imagine all lions as forming *one* big lion. (We say: "God created man".)

Then it would be possible to set up the paradox that there isn't a definite number of all lions. And so on.

Page Break 404

Page 404

But would it be impossible to count and calculate in such a language?

Page 404

37. We might ask: What role can a sentence like "I always lie" have in human life? And here we can imagine a variety of things.

Page 404

38. Is turning inches into centimetres logical inference? "The cylinder is 2 inches long.--So it is about 5 cm. long." Is that a *logical* inference?†1

Page 404

But isn't a rule something arbitrary? Something that I *lay down*? And could I lay it down that the multiplication 18×15 shall *not* yield 270?--Why not?--But then it just hasn't taken place according to the rule which I first laid down, and whose use I have practised.

Is something that follows from a rule itself in turn a rule? And if not,--what kind of proposition am I to call it?

Page 404

"It is... impossible for human beings to recognize an object as different from itself." Well, if only I had an inkling how it is done,--I should try at once!--But, if it is impossible for us to recognize an object as different from itself, is it quite possible to recognize two objects as different from one another? I have e.g. two chairs before me and I recognize that they are *two*. But here I may sometimes believe that they are only *one*; and in *that* sense I can also take one for two.--

Page Break 405

But that doesn't mean that I recognize the chair as different from itself! Very well; but then neither have I recognized the two as different from one another. If you think you can do this and you are playing a kind of psychological game, then translate it into a game with gestures. When you have two objects before you, point with each hand at one of them; as if, as it were, you wanted to indicate that they were independent. If you only have one object before you then you point to it with both hands in order to indicate that no difference between it and itself can be made.--But now, why should one not play the game the opposite way?

Page 405

39. The words "right" and "wrong" are used when giving instruction in proceeding according to a rule. The word "right" makes the pupil go on, the word "wrong" holds him back. Now could one explain these words to a pupil by saying instead: "this agrees with the rule--that not"? Well yes, if he has a concept of agreement. But what if this has yet to be formed? (The point is how he reacts to the word "agree".)

Page 405

One does not learn to obey a rule by first learning the use of the word "agreement".

Page 405

Rather, one learns the meaning of "agreement" by learning to follow a rule.

Page 405

If you want to understand what it means "to follow a rule", you have already to be able to follow a rule.

Page Break 406

Page 406

"If you accept this rule you *must* do this."--This may mean: the rule doesn't leave two paths open to you here. (A mathematical proposition.) But I mean: the rule conducts you like a gangway with rigid walls. But against this one can surely object that the rule could be interpreted in all sorts of ways.--Here is the rule, like an order! And like an order too in its *effect*.

Page 406

40. A language-game: to bring something *else*; to bring the *same*. Now, we can imagine how it is played.--But how can I explain it to anyone? I can give him this training.--But then how does he know what he is to bring the next time as 'the same'--with what justice can I say that he has brought the right thing or the wrong?--Of course I know very well that in certain cases people would turn on me with signs of opposition.

And does this mean e.g. that the definition of "same" would be this: same is what all or most human beings with one voice take for the same?--Of course not.

Page 406

For of course I don't make use of the agreement of human beings to affirm identity. What criterion do you use, then? None at all.

Page 406

To use the word without a justification does not mean to use it wrongfully.

Page 406

The problem of the preceding language-game exists also here: Bring me something red. For what shews me that something is red? The

Page Break 407

agreement of the colour with a sample?--What right have I to say: "Yes, that's red"? Well, I say it; and it cannot be justified. And it is characteristic of this language-game as of the other that all men consent in it without question.

Page 407

An undecided proposition of mathematics is something that is accepted neither as a rule nor as the opposite of a rule, and which has the form of a *mathematical* statement.--But is this form a sharply circumscribed concept?

Page 407

Imagine $\lim_{n \rightarrow \infty} \phi_n = e$ as a property of a piece of music (say). But of course not as if the piece went on endlessly, but as a property that can be recognized by the ear (as it were an *algebraic* property) of the piece.

Page 407

Imagine equations used as ornaments (wallpaper patterns), and now a test of these ornaments with a view to discovering what kind of curves they correspond to. The test would be analogous to that of the contrapuntal properties of a piece of music.

Page 407

41. A proof that shews that the pattern '777' occurs in the expansion of π , but does not shew *where*.†1 Well, proved in this way this 'existential proposition' would, for certain purposes, not be a *rule*. But might it not serve e.g. as a means of classifying expansion rules? It would perhaps be proved in an analogous way that '777' does not occur in π^2 but it does occur in $\pi \times e$ etc. The question would simply be: is it reasonable to say of the proof concerned: it proves the existence

Page Break 408

of '777' in this expansion? This can be simply misleading. It is in fact the curse of prose, and particularly of Russell's prose, in mathematics.

Page 408

What harm is done e.g. by saying that God knows *all* irrational numbers? Or: that they are already all there, even though we only know certain of them? Why are these pictures not harmless?

Page 408

For one thing, they hide certain problems.--

Page 408

Suppose that people go on and on calculating the expansion of π . So God, who knows everything, knows whether they will have reached '777' by the end of the world. But can his *omniscience* decide whether they *would* have reached it after the end of the world? It cannot. I want to say: Even God can determine something mathematical only by mathematics. Even for him the mere rule of expansion cannot decide anything that it does not decide for us.

Page 408

We might put it like this: if the rule for the expansion has been given us, a *calculation* can tell us that there is a '2' at the fifth place. Could God have known this, without the calculation, purely from the rule of expansion? I want to say: No.

Page 408

42. When I said that the propositions of mathematics determine concepts, that is *vague*; for '2 + 2 = 4' forms a concept in a different sense from ' $p \supset p$ ', ' $(x).fx \supset fa$ ', or Dedekind's Theorem. The point is, there is a family of cases.

Page Break 409

The concept of the rule for the formation of an infinite decimal is--of course--not a specifically mathematical one. It is a concept connected with a rigidly determined *activity* in human life. The concept of this rule is not more mathematical than that of: following the rule. Or again: this latter is not less sharply defined than the concept of such a rule itself.--For the expression of the rule and its sense is only a part of the language-game: following the rule.

One has the *same* right to speak of such rules in general, as of the activities of following them.

Of course, we say: "all this is involved in the concept itself", of the rule for example--but what that means is that we incline to *these* determinations of the concept. For what have we in our heads, which of itself contains all these determinations?

A number is, as Frege says, a property of a concept--but in mathematics it is a mark of a mathematical concept. \hat{A}_0 is a *mark* of the concept of a cardinal number; and the *property* of a technique. $2\hat{A}_0$ is a mark of the concept of an infinite decimal, but what is this number a property of? That is to say: of what kind of concept can one assert it empirically?

43. The proof of a proposition shews me what I am prepared to stake on its truth. And different proofs can perfectly well cause me to stake the same thing.

Something surprising, a paradox, is a paradox only in a particular, as it were defective, surrounding. One needs to complete this surrounding in such a way that what looked like a paradox no longer seems one.

If I have proved that $18 \times 15 = 270$, I have thereby also proved the geometrical proposition that we get the sign '270' by applying certain transformation rules to the sign '18 \times 15'.--Now suppose that people, having their vision or memory impaired (as we now put it) by some harmful drug, did not get '270' when they did this calculation.--If we cannot use it to make a correct prediction of the result anyone is going to get under normal circumstances, isn't the calculation useless? Well, even if it is, that does not shew that the proposition '18 \times 15 = 270' is the empirical proposition: people in general calculate like *this*.

On the other hand it is not clear that the general agreement of people doing calculations is a characteristic mark of all that is called "calculating". I could imagine that people who had learned to calculate might in particular circumstances, say under the influence of opium, begin to calculate differently from one another, and might make use of these calculations; and that they were not said not to be calculating at all and to be deranged--but that their calculations were accepted as a reasonable procedure.

But must they not at least be trained to do the same calculations? Doesn't *this* belong essentially to the concept of calculating? I believe that we could imagine deviations here too.

44. Can we say that mathematics teaches an experimental method of investigation, teaches us to formulate empirical questions (cf. p. 381).†1

Can't it be said to teach me e.g. to ask whether a particular body moves according to the equation of a parabola?--What does mathematics do in this case? Without it, or without the mathematicians, we should of course not have arrived at the definition of this curve. But was defining this curve itself a piece of mathematics? Would it for instance imply mathematics for people to investigate the movement of a body so as to see whether its path can be represented by the construction of an ellipse with two pegs and a string? Was whoever invented this inquiry doing mathematics?

He did create a new *concept*. But was it in the same way as mathematics does? Was it like the way the multiplication $18 \times 15 = 270$ gives us a new concept?

45. Then *can't* one say that mathematics teaches us to count? But if it teaches us to count, then why doesn't it also teach us to compare colours?

It is clear that if someone teaches us the equation of an ellipse he is teaching us a new concept. But if someone proves to us that *this* ellipse and *this* straight line intersect at these points--he too is giving us a new concept.

Page 411

Teaching us the equation of an ellipse is like teaching us to count. But it is also like teaching us to ask the question: "Are there a hundred times as many marbles here as there?"

Page 411

Now if I had taught someone this question in a language-game, and a method of answering it, should I have taught him mathematics? Or

Page Break 412

would it have been that only if he operated with signs?

Page 412

(Would that be like asking: "Would it be geometry, even if it *only* consisted of the Euclidian axioms?")

Page 412

If arithmetic teaches us the question "how many?", then why doesn't it also teach the question "how dark?"?

Page 412

Is a new conceptual connexion a new concept? And does mathematics create conceptual connexions?

Page 412

But the question "are there a hundred times as many marbles here as there?" is surely not a mathematical question. And the answer to it is not a mathematical proposition. A mathematical question would be: "are 170 marbles a hundred times as many as 3 marbles?" (And this is a question of pure, not of applied mathematics.)

Page 412

Now ought I to say that whoever teaches us to count etc. gives us new concepts; and *also* whoever uses such concepts to teach us pure mathematics?

Page 412

The word "concept" is too vague by far.

Page Break 413

Page 413

Mathematics teaches us to operate with concepts in a new way. And hence it can be said to change the way we work with concepts.

Page 413

But only a mathematical proposition that has been proved or that is assumed as a postulate does this, not a problematic proposition.

Page 413

46. But can we not experiment mathematically? for instance, try whether a square bit of paper can be folded into a cat's head, where the *physical* properties of the paper, such as stiffness or elasticity, don't come into the question? Now certainly we speak of trying here. And why not of experimenting too? This case is like one in which we substitute pairs of numbers in the equation $x^2 + y^2 = 25$ in order to find by trial and error one that satisfies the equation. And if one finally arrives at $3^2 + 4^2 = 25$, is this proposition now the result of an experiment? For why did we call our procedure "trying"? Should we also have called it that if someone always solved such problems first time off with complete certainty (giving the signs of certainty) but without calculating? What did the experiment consist in here? Suppose that before he gives the solution, he has a vision of it.--

Page 413

47. If a rule does not compel you, then you aren't *following* a rule.

Page 413

But how am I supposed to be following it; if I can after all follow it as I like?

Page Break 414

Page 414

How am I supposed to follow a sign-post, if whatever I do is a way of following it?

Page 414

But, that everything can (also) be *interpreted* as following, doesn't mean that everything is following.

Page 414

But how then does the teacher interpret the rule for the pupil? (For he is certainly supposed to give it a particular interpretation.)--Well, how but by means of words and training?

And if the pupil reacts to it thus and thus; he possesses the rule inwardly.

But *this* is important, namely that this reaction, which is our guarantee of understanding, presupposes as a surrounding particular circumstances, particular forms of life and speech. (As there is no such thing as a facial expression without a face.)

(This is an important movement of thought.)

Page 414

48. Does a line compel me to trace it?--No; but if I have decided to use it as a model in *this* way, then it compels me.--No; then *I* compel myself to use it in this way. I as it were cleave to it.--But here it is surely important that I can form the decision with the (general) interpretation so to speak once for all, and can hold by it, and do not *interpret* afresh at every step.

Page 414

The line, it might be said, intimates to me how I am to go. But that is of course only a picture. And if I judge that it intimates this or that to me as it were irresponsibly, then I would not say that I was following it *as a rule*.

Page Break 415

Page 415

"The line intimates to me how I am to go": that is merely a paraphrase for:--it is my *last* court of appeal for how I am to go.

Page 415

49. Imagine someone was following a line as a rule in this way: he holds a pair of compasses, one point of which he carries along the rule, while the other point draws the line that follows the rule. And as he goes along the rule-line in this fashion, he opens and doses the compasses, to all appearances with great exactness; as he does this, he keeps on looking at the rule, as if *it* determined what he was doing. Now we, who are watching him, can see no regularity of any kind in this opening and shutting. Hence we cannot learn his way of following the rule from him either. But we believe him when he tells us that the line intimated to him to do what he did.

Page 415

Here we should perhaps really say: "The model seems to *intimate* to him how he has to go. But it isn't a rule."

Page 415

50. Suppose someone follows the series "1, 3, 5, 7, ..." in writing the series $2x + 1$; and he asked himself "But am I always doing the same thing, or something different every time?"

If from one day to the next someone promises: "Tomorrow I will give up smoking," does he say the same thing every day, or every day something different?

Page 415

How is it to be decided whether he always does the same, when the line intimates to him how he is to go?

Page Break 416

Page 416

51. Didn't I want to say: Only the total picture of the use of the word "same" as it is interwoven with the uses of the other words, can determine whether he does use the word as we do?

Page 416

Doesn't he always do the same, namely, let the line intimate to him how he is to go? But suppose he says that the line intimates now this to him and now that? Couldn't he now say: in *one* sense he is always doing the same thing, but still he isn't following a rule? And cannot the one who is following a rule nevertheless also say that in a certain sense he does something different every time? Thus whether he does the same thing or keeps on doing something different does not determine whether he is following a rule.

Page 416

The procedure of following a rule can be described only like this: by describing in a different way what we do in the course of it.

Would it make sense to say: "If he did something *different* every time, we should not say he was following a rule"? That does *not* make sense.

Page 416

52. Following a rule is a particular language-game. How can it be described? When do we say he has understood the description?--We do this and that; if he now reacts in such-and-such a way, he understood the game. And this "this and that," "in such-and-such a way" doesn't contain an "and so on."--Or: if I used an "and so on" in the description, and were to be asked what that meant, I should have to explain that in turn by the narration of examples; or perhaps by means of a gesture. And I should then regard it as a sign of understanding, if

he, say, repeated the gesture with an intelligent expression; and in special cases acted in such-and-such a way.

"But then doesn't the understanding reach beyond all the examples?" A very remarkable expression, and one that is entirely natural.

When one recounts examples and then says "and so on", this latter expression does not get explained in the same way as the examples.

For the "and so on" might on the one hand be replaced by an arrow, which indicates that the end of the series of examples is not supposed to signify an end of their application. On the other hand "and so on" also means: that's enough, you've understood; we don't need any more examples.

If we replace the expression by a gesture, it might easily be that people only took our series of examples as they were supposed to (only followed it correctly) when we made this gesture at the end. Thus it would be quite analogous to pointing to an object or a place.

53. Let us imagine a line intimating to me how I am to follow it; that is, as my eye travels along the line a voice within me says: "*This* way!"--What is the difference between this process of obeying a kind of inspiration and that of obeying a rule? For they are surely not

the same. In the case of inspiration I *await* direction. I shall not be able to teach anyone else my 'technique' of following the line. Unless, indeed, I teach him some way of hearkening, some kind of receptivity. But then, of course, I cannot require him to follow the line in the same way as I do.

It would also be possible to imagine such instruction in a sort of calculating. The children can calculate, each in his own way--as long as they listen to their inner voice and obey it. Calculating in this way would be something like composing.

For doesn't the technique (the *possibility*) of training someone else in following it belong to the following of a rule? To be sure, by means of examples. And the criterion of his understanding must be the agreement of their individual actions. Hence it is not as it is with instruction in receptivity.

54. How do you follow the rule?--"I do it like *this*;..." and now there follow general explanations and examples.--How do you follow the voice of the line?--"I look at it, exclude all thoughts, etc., etc."

"I wouldn't say that it kept on intimating something else to me--if I were following it as a rule". Can one say that? "Doing the same" is tied up with "following the rule."

55. Can you imagine having absolute pitch, if you don't have it? Can you imagine it, *if* you do?--Can a blind man imagine the seeing of red? Can *I* imagine it? Can I imagine spontaneously reacting in such-and-such a way if I don't do so? Can I imagine it better, if I do do so?

But can I play the language-game, if I don't react in this way?

56. One does not feel that one must always be awaiting the tip-off of the rule. On the contrary. We are not excited about what it will tell us to do next, rather it always tells us the same thing, and we do what it says.

It might be said: we look at what we do in following according to the rule from the point of view: *always the same*.

You might say to someone you were beginning to train: "See, I always do the same:..."

57. When do we say: "the line intimates this to me *as a rule*--always the same." And on the other hand: "It keeps on intimating to me what I have to do--it is not a rule."

In the first case the story is: I have no further court of appeal for what I have to do. The rule does it all by itself; I need only follow it (and following just is *one thing*). I don't feel for example that it's queer that the line always tells me something.--

Page Break 420

Page 420

The other proposition says: I don't know what I shall do; the line will tell me.

Page 420

Calculating prodigies, who reach the right result, but cannot tell how. Are we to say: they don't calculate? (A family of cases.)

Page 420

These things are finer spun than crude hands have any inkling of.

Page 420

58. May I not *believe* I am following a rule? Doesn't this case exist?

Page 420

And if so, then may I not also believe I am *not* following a rule and yet be following a rule? Isn't there something that we should call *that*, too?

Page 420

59. How can I explain the word "same"?--Well, by means of examples.--But is that *all*? Isn't there a still deeper explanation; or must not the *understanding* of the explanation be deeper?--Well, have I myself a deeper understanding? *Have* I more than I give in the explanation?

But whence arises the feeling, as if I had more than I can say?

Page 420

Is it that I interpret the not-limited as length which reaches further than any given length? (The permission that is not limited, as a permission for something limitless.)

Page 420

The image that goes with the limitless, is of something so big that we can't see its end.

Page Break 421

Page 421

The employment of the word "rule" is interwoven with the employment of the word "same".

Page 421

Consider: Under what circumstances will the explorer say: The word "..." of this tribe means the same as our "and so on"? Imagine the details of their life and their language, which would justify him in this.

Page 421

"But I know what 'same' means!"--I have no doubt of that; I know it too.

Page 421

60. "The line intimates to me..." Here the emphasis is on the *impalpability* of the intimating. On this: that *nothing* stands between the rule and my action.

Page 421

One could however imagine that someone multiplied, multiplied correctly, with such feelings; kept on saying: "I don't know--now suddenly the rules intimates *this* to me!" and that we reply: "Of course; for you are going ahead perfectly in accordance with the rule."

Page 421

Following a rule: this can be contrasted with various things. Among other things the explorer will also describe the circumstances under which someone of these people doesn't want to say he is following a rule. Even when in this or that respect it looks as if he were.

Page Break 422

Page 422

But might we not also calculate as we do calculate (all agreeing), etc., and yet at every step have the feeling of being guided by the rule as if by a spell; astonished maybe at agreeing with one another? (Thanking the deity perhaps for this agreement.)

Page 422

From this you can just see how much there is to the physiognomy of what we call "following a rule" in

everyday life!

Page 422

One follows the rule *mechanically*. Hence one compares it with a mechanism.

Page 422

"Mechanical"--that means: without thinking. But *entirely* without thinking? Without *reflecting*.

Page 422

The explorer might say: "they follow rules, but it looks different from the way it looks among us."

Page 422

"It--for no reason--intimates this or that to me" means: I can't teach you *how* I follow the line. I make no presumption that you will follow it as I do, even if you do follow it.

Page 422

61. An addition of shapes together, so that some of the edges fuse, plays a very small part in our life.--As when

Page Break 423

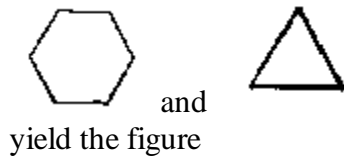

But if this were an *important* operation, our ordinary concept of arithmetical addition would perhaps be different.

Page 423

It is natural for us to regard it as a geometrical fact, not as a fact of physics, that a square piece of paper can be folded into a boat or hat. But is not geometry, so understood, part of physics? No; we split geometry off from physics. The geometrical possibility from the physical one. But what if we left them together? If we simply said: "If you do this and this and this with the piece of paper then *this* will be the result"? What has to be done might be told in a rhyme. For might it not be that someone did not distinguish at all between the two possibilities? As e.g. a child who learns this technique does not. It does not know and does not consider whether these results of folding are possible only because the paper stretches, is pulled out of shape, when it is folded in such-and-such a way, or because it is *not* pulled out of shape.

Page 423

And now isn't it like this in arithmetic too? Why shouldn't it be possible for people to learn to calculate without having the concepts of a mathematical and a physical fact? They merely know that this

Page Break 424

is always the result when they take care and do what they have learnt.

Let us imagine that while we were calculating the figures on paper altered erratically. A 1 would suddenly become a 6 and then a 5 and then again a 1 and so on. And I want to assume that this does not make any difference to the calculation because, as soon as I read a figure in order to calculate with it or to apply it, it once more becomes the one that we have in *our* calculating. At the same time, one would see how the figures change during the calculation; but we are trained not to worry about this.

Of course, even if we do not make the above assumption, this calculation could lead to useful results.

Here we calculate strictly according to rules, yet this result does not *have* to come out.--I am assuming that we see no sort of regularity in the alteration of the figures.

Page 424

I want to say: this calculating could really be conceived as an experiment, and we might for example say: "Let's try what will come out now if I apply this rule".

Page 424

Or again: "Let us make the following experiment: we'll write the figures with ink of such-and-such a composition... and calculate according to the rule...."

Now you might of course say: "In this case the manipulation of figures according to rules is not calculation."

"We are calculating only when there is a *must* behind the result."--But suppose we don't know this *must*,--is it contained in the calculation

all the same? Or are we not calculating, if we do it quite naïvely?

How about the following: You aren't calculating if, when you get now this, now that result, and cannot find a mistake, you accept this and say: this simply shews that certain circumstances which are still unknown have an influence on the result.

This might be expressed: if calculation reveals a causal connexion to you, then you are not calculating.

Our children are not only given practice in calculation but are also trained to adopt a particular attitude towards a mistake in calculating.†1

What I am saying comes to this, that mathematics is *normative*. But "norm" does not mean the same thing as "ideal".

62. The introduction of a new rule of inference can be conceived as a transition to a new language-game. I can imagine one in which for example one person pronounces: ' $p \supset q$ ', another ' p ' and a third draws the conclusion.

63. Is it possible to observe that a surface is coloured red and blue;

and not to observe that it is red? Imagine that a kind of colour adjective were used for things that are half red and half blue: they are said to be 'bu'. Now might not someone be trained to observe whether something is bu; and not to observe whether it is also red? Such a man would then only know how to report: "bu", or "not bu". And from the first report we could draw the conclusion that the thing was partly red.

I am imagining that the observation happens by means of a psychological sieve, which for example only lets through the fact that the surface is blue-white-red (the French tricolour) or that it is not.

Now if it is a special observation that the surface is partly red, how can this follow logically from the preceding? Surely logic cannot tell us what to observe.

Someone is counting apples in a box; he counts up to 100. Someone else says: "so there are at any rate 50 apples in the box" (that is all that interests him). This is surely a logical conclusion; but isn't it also a special piece of experience?

64. A surface which is divided into a number of strips is observed by several people. The colours of the strips change every minute, all at the same time.



Now the colours are: red, green, blue, white, black, blue.

It is observed:

red. blue \supset black. \supset . white.

It is also observed:

\sim green \supset \sim white

and someone draws the conclusion:

$\sim \text{green} \supset: \text{red. blue. } \sim \text{black.}$

And these implications are 'material implications' in Russell's sense.

Page 427

But then is it possible to *observe* that

$\text{red. blue} \supset \text{black.} \supset. \text{white?}$

Isn't one observing *arrangements* of colours, and so for example that red.blue.black.white; and then deducing that proposition?

But may not someone who is observing a surface be quite preoccupied with the question whether it is going to turn green or not green; and if he now sees: $\sim \text{green}$, need he be attentive to the particular colour that the surface is?

And might not someone be preoccupied with the aspect $\text{red.blue} \supset \text{black.} \supset. \text{white?}$ If, for example, he has been taught to forget everything else, and only to look at the surface from this point of view. (In particular circumstances it might be all one to people whether objects were red or green but important whether they had one of these colours or some third one. And in this case there might be a colour word for "red or green".)

Page 427

But if one can observe that

$\text{red. blue} \supset: \text{black.} \supset. \text{white}$

and

$\sim \text{green} \supset \sim \text{white}$

Page Break 428

then one can also observe, and not merely infer, that

$\sim \text{green} \supset: \text{red. blue. } \sim \text{black.}$

Page 428

If these are three observations then it must also be possible for the third observation not to agree with the logical conclusion from the first two.

Page 428

Then is it imaginable that someone observing a surface should see the combination red-black (say as a flag), but if he now sets himself to see *one* of the two halves, he sees blue instead of red? Well, you have just described it.--It would perhaps be as if someone were to look at a group of apples and always see it as two groups of two apples each, but as soon as he tried to take the whole lot in at a glance, they seemed to him to be five. This would be a very remarkable phenomenon. And it is not one of whose possibility we take any notice.

Page 428

Remember that a rhombus, seen as a diamond, does not look like a parallelogram. Not that the opposite sides seem *not* to be parallel, only the parallelism does not strike us.

Page 428

65. I could imagine someone saying that he saw a red and yellow star but did not see anything yellow--because he sees the star as, so to speak, a *conjunction* of coloured parts, which he cannot separate.

Page 428

For example he had figures like these before him:

Page Break 429



Asked whether he sees a red pentagon he would say "yes"; asked whether he sees a yellow one, "no". In the same

way he says that he sees a blue triangle but not a red one.--When his attention was drawn to it perhaps he said: "Yes, now I see it; I had not taken the star like that."

Page 429

And it might seem to him that you can't separate the colours in the star, because you can't separate the shapes.

Page 429

You cannot learn to view the geography of a landscape as a whole, if you move on in it so slowly that you have already forgotten one bit when you come to another.

Page 429

66. Why do I always speak of being compelled by a rule; why not of the fact that I can *choose* to follow it? For that is equally important.

But I don't want to say, either, that the rule compels me to act like this; but that it makes it possible for me to hold by it and let it compel me.

Page 429

And if e.g. you play a game, you keep to its rules. And it is an interesting fact that people set up rules for the fun of it, and then keep to them.

Page Break 430

Page 430

My question really was: "How can one keep to a rule†1?" And the picture that might occur to someone here is that of a short bit of handrail, by means of which I am to let myself be guided further than the rail reaches. [But there *is* nothing there; but there isn't *nothing* there!] For when I ask "How can one...", that means that something here looks *paradoxical* to me; and so a picture is confusing me.

Page 430

"I never thought of its being red too; I only saw it as part of a multi-coloured ornament."

Page 430

Logical inference is a transition that is justified if it follows a particular paradigm and its rightness is not dependent on anything else.

Page 430

67. We say: "If you really follow the rule in multiplying, you *must* all get the same result." Now if this is only the somewhat hysterical way of putting things that you get in university talk, it need not interest us overmuch.

It is however the expression of an attitude towards the technique of calculation, which comes out everywhere in our life. The emphasis of the *must* corresponds only to the inexorableness of this attitude both to the technique of calculating and to a host of related techniques.

Page 430

The mathematical Must is only another expression of the fact that mathematics forms concepts.

Page Break 431

Page 431

And concepts help us to comprehend things. They correspond to a particular way of dealing with situations.

Page 431

Mathematics forms a network of norms.

Page 431

68. It is possible to see the complex formed of A and B, without seeing A or B. It is even possible to call the complex a "complex of A and B" and to think that this name points to some kind of kinship of this whole with A and with B. Thus it is possible to say that one is seeing a complex formed from A and B but neither A nor B. As for example one might say that there is a reddish yellow here but neither red nor yellow.

Page 431

Now can I have A and B before me and also see them both, but only observe $A \vee B$? Well, in a certain sense this is surely possible. I was thinking of it like this: the observer is preoccupied with a particular aspect; for example, he has a special kind of paradigm before him; he is engaged in a particular routine of application.--And just as he can be adjusted to $A \vee B$, so he can also be adjusted to A.B. Thus only A.B strikes him, and not, for example, A. To be adjusted to $A \vee B$ might be said to mean: to react to such-and-such a situation with the concept 'A \vee B'. And one can of course do exactly the same thing with A.B too.

Page 431

Say someone is interested only in A.B, and so whatever happens he judges merely either "A.B", or " $\sim(A.B)$ ";

then I can imagine his judging "A.B" and saying "No, I see A.B" when he is asked "Do you see B?" As for example some people who see A.B will not concede that they see $A \vee B$.

Page Break 432

Page 432

69. But 'seeing' the surface 'blue all over' and 'seeing' it 'red all over' are surely 'genuine' experiences, and yet we say that a man could not have them at the same time.

Page 432

Now suppose he assured us that he saw this surface really red all over and blue all over at the same time? We should have to say: "You aren't making yourself intelligible to us."

Page 432

With us the proposition "1 foot = ... cm." is timeless. But we could imagine the case in which the foot and the metre gradually altered somewhat, and kept on having to be compared anew in order for us to calculate their translations into one another.

Page 432

But have we not determined the relative length of foot and metre experimentally? Yes; but the result was given the character of a rule.

Page 432

70. In what sense can a proposition of arithmetic be said to give us a concept? Well let us interpret it, not as a proposition, as something that decides a question, but as a--somehow accepted--connexion of concepts.

Page 432

The equating of 25^2 and 625 could be said to give me a new concept. And the proof shews what the position is regarding this equality.--"To give a new concept" can only mean to introduce a new employment of a concept, a new practice.

Page Break 433

Page 433

"How can the proposition be separated from its proof?" This question betrays a false conception.

Page 433

The proof is part of the *surroundings* of the proposition.

Page 433

'Concept' is a vague concept.

Page 433

71. It is not in every language-game that there occurs something that one would call a concept.

Page 433

Concept is something like a picture with which one compares objects.

Page 433

Are there concepts in language-game (2)†1? Still, it would be easy to add to it in such a way that "slab", "block" etc. became concepts. For example, by means of a technique of describing or portraying those objects. There is of course no sharp dividing line between language-games which work with concepts and others. What is important is that the word "concept" refers to one kind of expedient in the mechanism of language-games.

Page Break 434

Page 434

72. Consider a mechanism. For example this one:

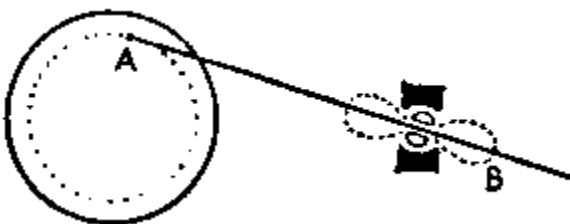

While the point *A* describes a circle, *B* describes a figure eight. Now we write this down as a proposition of kinematics.

When I work the mechanism its movement proves the proposition to me; as would a construction on paper. The proposition corresponds e.g. to a picture of the mechanism with the paths of the points *A* and *B* drawn in. Thus

it is in a certain respect a picture of that movement. It holds fast what the *proof* shews me. Or--what it persuades me of.

Page 434

If the proof registers the procedure according to the rule, then by doing this it produces a new concept.

Page 434

In producing a new concept it convinces me of something. For it is essential to this conviction that the procedure according to these rules must always produce the same configuration. ('Same', that is, by our ordinary rules of comparison and copying.)

Page 434

With this is connected the fact that we can say that proof must shew the existence of an internal relation. For the internal relation is the operation producing one structure from another, seen as equivalent to the picture of the transition itself--so that now the transition

Page Break 435

according to this series of configurations is *eo ipso* a transition according to those rules for operating.

Page 435

In producing a concept, the proof convinces me of something: what it convinces me of is expressed in the proposition that it has proved.

Page 435

Problem: Does the adjective "mathematical" always mean the same: when we speak of "mathematical" concepts, of "mathematical" propositions and of mathematical proofs?

Page 435

Now what has the proved proposition got to do with the concept created by the proof? Again: what has the proved proposition got to do with the internal relations demonstrated by the proof?

Page 435

The picture (proof-picture) is an instrument producing conviction.

Page 435

It is clear that one can also apply an unproved mathematical proposition; even a false one.

Page 435

The mathematical proposition says to me: Proceed like this!

Page 435

73. "If the proof convinces us, then we must also be convinced of the axioms." Not as by empirical propositions, that is not their role. In the language-game of verification by experience they are excluded. Are, not empirical propositions, but principles of judgement.

Page Break 436

Page 436

A language-game: How have I to imagine one in which axioms, proofs and proved propositions occur?

Someone who hears a bit of logic for the first time at school is straightway convinced when he is told that a proposition implies itself, or when he hears the law of contradiction, or of excluded middle.--Why is he immediately convinced? Well, these laws fit entirely into the use of language that he is so familiar with. Then he learns perhaps to prove more complicated propositions of logic. The proofs are exhibited to him, and he is again convinced; or he invents proofs himself.

In this way he learns new techniques of inference. And also, what account to lay it to, if now errors appear.

Page 436

The proof convinces him that he must hold fast to the proposition, to the technique that it prescribed; but it also shews him how he can hold fast to the proposition without running any risk of getting into conflict with experience.

Page 436

74. Any proof in applied mathematics may be conceived as a proof in pure mathematics which proves that *this* proposition follows from *these* propositions, or can be got from them by means of such and such operations; etc.

Page 436

The proof is a particular *path*. When we describe it, we do not mention causes.

Page 436

I act on the proof.--But how?--I act according to the proposition that got proved.

The proof taught me e.g., a technique of approximation. But still it proved *something*, convinced me of something. *That* is expressed by the proposition: It says what I shall now do on the strength of the proof.

The proof belongs to the background of the proposition. To the system in which the proposition has an effect.

See, *this* is how 3 and 2 yield 5. Note this proceeding.

Every empirical proposition may serve as a rule if it is fixed, like a machine part, made immovable, so that now the whole representation turns around it and it becomes part of the coordinate system, independent of facts.

"This is how it is, if this proposition is derived from these ones. That you have to admit."--What I admit is, *this* is what I call such a procedure.

FOOTNOTES

†1 The numbering of Wittgenstein's manuscripts and typescripts follows that of the list given in the article "The Wittgenstein Papers" by G. H. von Wright in: *The Philosophical Review*, Vol. LXXVIII, 1969.

†1 *Principia Mathematica*: What is implied by a true premiss is true. Pp. (Eds.)

†1 Is 'this correlation' here the correlation of the patterns in the proof itself? A thing cannot be at the same time the measure and the thing measured. (Note in margin.)

†2 On the strength of the figure I shall e.g. try to effect one correlation, but not the other, and shall say that that one is not possible. (Note in margin.)

†1 See above, § 36. (Eds.)

†1 Cf. *Tractatus* 6.1261: In logic process and result are equivalent. (Eds.)

†1 The last sentence added in March, 1944. (Eds.)

†1 *Grundgesetze der Arithmetik* I, xviii. (Eds.)

†1 *ibid.*, I, XVI.

†1 This remark came at the end of the cut-up typescript which is the source of this Part I and the following Appendix I. (Cf. Preface, p. 33). But its place in the collection of cuttings is not quite clear--and for that reason the editors did not include the remark in the first edition. It is uncertain whether the words "Connected with this" relate to the preceding remarks 169 and 170. The remark was put between brackets in the typescript too. (Eds.)

†1 Several alternatives to the last sentence were indicated in the MS. "We fix our eye on the expression of meaning." "We investigate the expression of meaning." "We focus on the *expression* of meaning." "Focus on the expression of meaning." (Eds.)

†1 [Marginal note:] What is meant by "ne non *p*" and "non ne *p*"?

†1 This remark was in handwriting on the back of the page. (Eds.)

†1 But compare § 38. (Eds.)

†1 Probably refers to Bertrand Russell's article *The Limits of Empiricism. Proceedings of the Aristotelian Society*, 1935-1936. (Eds.)

- Page 208
†1 Cf. *Grundgesetze der Arithmetik*, Vol. I, Preface p. XVI. Compare also above, p. 95. (Eds.)
- Page 234
†1 *Philosophical Investigations*, § 2 quoted here *infra*, VI § 40n. (Eds.)
- Page 237
†1 See note, p. 197. (Eds.)
- Page 241
†1 *Grundgesetze der Arithmetik*, Vorwort, p. XVI.
- Page 264
†1 D. Hilbert. *Über das Unendliche*. *Mathematische Annalen* 95 (1926) (Translated in: Putnam and Bencic, *Philosophy of Mathematics*; also in Heijenoort, *From Frege to Gödel*.) Eds.
- Page 283
†1 I.e. Axiom of choice. (Eds.)
- Page 299
†1 Cf. Frege, *Die Grundlagen der Arithmetik*, § 65n; "Begriff ist für mich ein mögliches Prädikat..."; also: *Grundgesetze der Arithmetik* II, p. 69: "Eine Definition eines Begriffes (möglichen Prädikates) muss vollständig sein...". (Eds.)
- Page 305
†1 It is possible to devise a 'rule of counting' to fit the text--*e.g.* one of counting up the positions commanded from eight of the ten squares commanding nine (the colour of the bishop's diagonals being determinate). But we have not been able to find out what routine Wittgenstein did have in mind. (Eds.)
- Page 318
†1 An amendment of and addition to the fourth sentence of § 4, Part I, which runs: "And isn't *this* series just *defined* by this sequence?" (p. 37). In a revision belonging to about the same period as the present passage there then comes "Not by the sequence; but by a rule; or by the training in the use of a rule." (Eds.)
- Page 343
†1 §2 of *Philosophical Investigations*. An imaginary language 'is supposed to serve for communication between a builder A and an assistant B. A is constructing a building out of building stones; there are cubes, pillars, slabs and beams available. B has to pass him the blocks, and in the order that A needs them in. To this end they make use of a language consisting of the words "cube", "pillar", "slab" and "beam". A calls them out;--B brings the block that he has learnt to bring at this call. Conceive this as a complete primitive language.' (Eds.)
- Page 367
†1 cf. *Philosophical Grammar*, p. 369 f; cf. also *Philosophical Remarks*, pp. 183, 184. (Eds.)
- Page 379
†1 cf. p. 197 n.
- Page 387
†1 cf. note p. 197. (Eds.)
- Page 398
†1 cf. *Philosophical Investigations*, § 2, § 8. (Eds.)
- Page 400
†1 I.e. the Axiom of Choice. (Eds.)
- Page 400
†2 Presumably the king who made the law that all who came to his city must state their business and be hanged if they lied. A sophist said he came to be hanged under that law.--(Eds.)
- Page 402
†1 Cf. *Tractatus* 3.323. (Eds.)
- Page 403
†1 *Abhandlungen [[sic]] über die Fabeln*, in: G. E. Lessing, *Fabeln*, 1759. (Eds.)
- Page 404
†1 Cf. Part I, § 9. (Eds.)
- Page 407
†1 Cf. Part V, § 27. (Eds.)
- Page 410
†1 cf. p. 381.
- Page 425
†1 [Variant]:... towards a departure from the norm. (Ed.)
- Page 430

<tabs before most paragraphs need to be removed in Culture and Value>

CULTURE AND VALUE



Ludwig Wittgenstein from Blackwell Publishers

The Wittgenstein Reader

Edited by Anthony Kenny

Philosophical Investigations

Translated by G. E. M. Anscombe

Zettel

Second Edition

Edited by G. E. M. Anscombe and G. H. von Wright

Remarks on Colour

Edited by G. E. M. Anscombe

Remarks on the Foundations of Mathematics

Third edition

Edited by G. H. von Wright, Rush Rhees and G. E. M. Anscombe

Philosophical Remarks

Edited by Rush Rhees

Philosophical Grammar

Edited by Rush Rhees

On Certainty

Edited by G. E. M. Anscombe and G. H. von Wright

Lectures and Conversations

Edited by Cyril Barrett

Culture and Value

Edited by G. H. von Wright

The Blue and Brown Books

Preliminary Studies for the *Philosophical Investigations*

Remarks on the Philosophy of Psychology, Vol. I

Edited by G. E. M. Anscombe and G. H. von Wright

Remarks on the Philosophy of Psychology, Vol. II
Edited by G. E. M. Anscombe and Heikki Nyman

Last Writings on the Philosophy of Psychology, Vol. I
Edited by G. H. von Wright and Heikki Nyman

Last Writings on the Philosophy of Psychology, Vol. II
Edited by G. H. von Wright and Heikki Nyman

Page Break iii

Page Break iv

Page Break v

Titlepage

Page v

LUDWIG WITTGENSTEIN
Culture and Value

A Selection from the Posthumous Remains

Edited by
Georg Henrik von Wright
in Collaboration with Heikki Nyman

Revised Edition of the Text by
Alois Pichler

Translated by
Peter Winch



Page Break vi

Copyright page

Page vi

English translation copyright © Blackwell Publishers Ltd, 1998
German edition copyright © Suhrkamp Verlag, 1994

First edition of *Vermischte Bemerkungen* 1977
Second edition 1978

Amended second edition with English translation 1980
Reprinted 1984, 1988, 1989, 1992

Revised second edition of *Vermischte Bemerkungen* 1994
Revised second edition with English translation 1998
Reprinted 1998

Blackwell Publishers Ltd
108 Cowley Road
Oxford OX4 1JF
UK

Blackwell Publishers Inc.

350 Main Street
Malden, Massachusetts 02148
USA

All rights reserved. Except for the quotation of short passages for the purposes of criticism and review, no part of this publication may be reproduced, stored in a retrieval system, or transmitted, in any form or by any means, electronic, mechanical, photocopying, recording or otherwise, without the prior permission of the publisher.

Except in the United States of America, this book is sold subject to the condition that it shall not, by way of trade or otherwise, be lent, resold, hired out, or otherwise circulated without the publisher's prior consent in any form of binding or cover other than that in which it is published and without a similar condition including this condition being imposed on the subsequent purchaser.

British Library Cataloguing in Publication Data

A CIP catalogue record for this book is available from the British Library.

Library of Congress Cataloging-in-Publication Data

Wittgenstein, Ludwig. 1889-1951.

[Vermischte Bemerkungen. English & German]

Culture and value: a selection from the posthumous remains: Ludwig Wittgenstein: edited by Georg Henrik von Wright in collaboration with Heikki Nyman: revised edition of the text by Alois Pichler: translated by Peter Winch.--Rev. 2nd ed. with English translation.

p. cm.

Includes bibliographical references and indexes.

ISBN 0-631-20570-5 (alk. paper)--ISBN 0-631-20571-3 (pbk: alk. paper)

I. Philosophy-Miscellanea. I. Wright, G. H. von (Georg Henrik), 1916--. II. Nyman, Heikki. III. Pichler, Alois, 1966--. IV. Title.

B3376.W562E5 1997

192-dc21

96-37738

Page vi

CIP

Typeset in 10 on 12pt Sabon

by Ace Filmsetting Ltd, Frome, Somerset

Printed and bound by Athenaeum Press Ltd, Gateshead, Tyne & Wear

This book is printed on acid-free paper

Page Break vii

Page Break viii

Contents

Page viii

Foreword to the Edition of 1977	ixe
Foreword to the 1994 Edition	xii
Editorial Note	xiv
Note by Translator	xviii
<i>Culture and Value</i>	2e
A Poem	100e
Notes	101e
<i>Appendix</i>	105
List of Sources	107
List of Sources, Arranged Alphanumerically	113
Index of Beginning Remarks	120e

Page Break ix

Foreword to the Edition of 1977

Page ix

In the manuscript material left by Wittgenstein there are numerous notes which do not belong directly with his philosophical works although they are scattered among the philosophical texts. Some of these notes are autobiographical, some are about the nature of philosophical activity, and some concern subjects of a general sort,

such as questions about art or about religion. It is not always possible to separate them sharply from the philosophical text; in many cases, however, Wittgenstein himself hinted at such a separation--by the use of brackets or in other ways.

Page ix

Some of these notes are ephemeral; others on the other hand--the majority--are of great interest. Sometimes they are strikingly beautiful or profound. It was evident to the literary executors that a number of these notes would have to be published. G.H. von Wright was commissioned to make a selection and arrange it.

Page ix

It was a decidedly difficult task; at various times I had different ideas about how best to accomplish it. To begin with, for example, I imagined that the remarks could be arranged according to the topics of which they treated--such as "music", "architecture", "Shakespeare", "aphorisms of practical wisdom", "philosophy", and the like. Sometimes the remarks can be arranged into such groupings without strain, but by and large, splitting up the material in this way would probably give an impression of artificiality. At one time moreover I had thought of including already published material. For many of Wittgenstein's most impressive "aphorisms" are to be found in his philosophical works--in the *Notebooks* from the First World War, in the *Tractatus*, and in the *Investigations* too. I should like to say that it is when they are embedded in such contexts that Wittgenstein's remarks really have their most powerful effect. But for that very reason it did not seem to me right to tear them from their surroundings.

Page Break x

Page x

At one time too I played with the idea of not making a very extensive selection, but including only the "best" remarks. The impression made by the good remarks would, I thought, only be weakened by a great mass of material. *That*, presumably, is true--but it was not my job to be an arbiter of taste. Furthermore, I did not trust myself to choose between repeated formulations of the same, or nearly the same, thought. Often the repetitions themselves seemed to me to have a substantial point.

Page x

In the end I decided on the only principle of selection that seemed to me unconditionally right. I excluded from the collection notes of a purely "personal" sort--i.e. notes in which Wittgenstein is commenting on the external circumstances of his life, his state of mind and relations with other people--some of whom are still living. Generally speaking these notes were *easy* to separate from the rest and they are on a *different* level of interest from those which are printed here. Only in a few cases where these two conditions seemed not to be met did I include notes of an autobiographical nature as well.

Page x

The remarks are published here in chronological order with an indication of their year of origin. It is conspicuous that nearly half the remarks stem from the period after the completion (in 1945) of Part One of *Philosophical Investigations*.

Page x

In the absence of further explanation some of the remarks will be obscure or enigmatic to a reader who is not familiar with the circumstances of Wittgenstein's life or with what he was reading. In many cases it would have been possible to provide explanatory comments in footnotes. I have nevertheless, with very few exceptions, refrained from adding comments. I ought to add that all the footnotes are the editor's. †1

Page x

It is unavoidable that a book of this sort will reach the hands of readers to whom otherwise Wittgenstein's philosophical work is, and will remain, unknown. This need not necessarily be harmful or useless. I am all the same convinced that these notes can be properly understood and appreciated only against the background of Wittgenstein's philosophy and, furthermore, that they make a contribution to our understanding of that philosophy.

Page x

I began making my selection from the manuscripts in the years 1965-6. I then laid the work aside until 1974. Mr Heikki Nyman helped me with the final selection and arrangement of the collection. He also checked that the next agreed exactly with the manuscripts and removed many errors and

Page Break xi

gaps from my typescript. I am very grateful to him for his work, which he carried out with great care and good taste. Without his help I should probably not have been able to bring myself to complete the collection for the press. I am also deeply indebted to Mr Rush Rhees for making corrections in the text which I produced and for giving me valuable advice on matters of selection.

Page Break xii

Foreword to New Edition 1994

Page xii

The present new version of the text of *Vermischte Bemerkungen* is the work of Alois Pichler. Mr Pichler, who works at the *Wittgenstein Archive of the University of Bergen*†*, has newly transcribed from the manuscripts all the remarks. In the process a few mistakes in the earlier editions were corrected, mainly places which had been difficult to read correctly. Some of these corrections had already been noticed by the original editor in the course of the years.

Page xii

The new edition contains all the remarks of the earlier editions and only those. However they appear here edited more completely and more faithfully to the original. Wittgenstein usually wrote his remarks in short sections, separated from each other by one or more blank lines. Some of the remarks printed in the earlier editions consisted simply of "extracts" from these sections, i.e. often parts were left out which did not seem relevant to the editor. This is a judgement that might appear controversial to some; for this reason in the present edition all such passages have been completed so as to comprise the totality of the section. Another new feature is that variants are retained in footnotes--formerly the editor had made a choice. The musical notation and the drawings are this time reproduced in facsimile; thanks are due to Michael Biggs of the University of Hertfordshire for his advice and help. Many will be pleased that the sources of the remarks are cited.†** (See Alois Pichler's Editorial Note for more details about editing.)

Page Break xiii

At the end of the remarks there is a poem which was in the possession of Hofrat Ludwig Hänsel, to whom Wittgenstein had given it. We assume that it was written by Wittgenstein. Here the poem is reproduced as a facsimile of the surviving typescript. There is supposed to have been a handwritten version too, which has probably been lost. It is not known when the poem was composed. The Wittgenstein Trustees thank Prof. Dr Hermann Hänsel, Vienna, for making this unique document available.

Page xiii

Alois Pichler and I thank the *Wittgenstein Archive of the University of Bergen* for professional and technical support.

Helsinki, November 1993

Georg Henrik von Wright

Page Break xiv

Editorial Note

Page xiv

History of the Edition: The *Vermischte Bemerkungen* were first published in 1977. In 1978 a new edition appeared with supplementary remarks. The edition of 1978 was corrected and expanded in Volume 8 in the complete works, 1984; between "Es ist als hätte ich mich verirrt (...)" and "Sind *alle* Leute große Menschen? (...)" (1978: p. 93) was inserted the remark "Je weniger sich Einer selbst kennt (...)" (1984: p. 516). For this reason the latter remark is not included in the English edition of 1980. The present new edition contains all the remarks of the edition of 1984 and--apart from the completion of the context to include the full section and the noting of the variants--only those remarks.

Page xiv

Sources: The manuscript source is given after each remark: "MS #" refers to the manuscript number in Georg Henrik von Wright's catalogue of the *Nachlaß*†*. Following the manuscript number the page is cited on which the remark begins (Folio pagination is distinguished according to recto and verso by "r" and "v"; identical pagination is distinguished according to left and right by "a" and "b".) The date of writing is also given, where this can be ascertained.

Page xiv

Arrangement: The remarks are arranged chronologically; this has led to fairly extensive rearrangements in relation to the earlier editions. For remarks which follow immediately one after another in the original, the source has been given after the last of those remarks, so that the original grouping may be clear in this edition.

Page xiv

Context: All remarks, i.e. all passages separated from each other by blank

lines and not indented, correspond to whole sections in the original; whereas the former editions sometimes contained only parts of sections, the complete section is reproduced here. Completions of this sort are marked in the citation of sources with an asterisk * (see e.g. the first remark). Further sections were added to the remark "Architecture immortalizes (...)" (1978: p. 133; 1984: p. 548; here p. 74), as they constitute different versions of it and in the manuscript are on the same or the previous side. In the earlier editions this passage was marked with "Several variants in the manuscript". With remarks which belong together and which are here edited under the same indication of source, but which in the original are separated from each other by one or more sections not published here, the omission of the relevant section(s) is indicated with (...) (e.g. as on p. 75).

Code: Several of the published remarks are written in the original partly or wholly in Wittgenstein's code; this is registered in the indication of source with a "c" for "code", following the page number. The code, roughly, consists in the reversal of the alphabet, in detail in the following correlations (read "a is z", "b is y", etc.):

a	z	h	s	n	n	u	f
b	y	hh	ss/ß	o	m	v	e
c	x	i	r	p	l	w	d
d	w	k	q	q	k	x	d
e	v	l	p	r	i/j	y	b
f	u	m	o	s	h	z	a
&funk;	ü	&munk;	ö	t	g	&zunk;	ä

g t
"Rsx", e.g., is when decoded "Ich".

Completeness: In the originals many of the remarks are marked with working signs and lines in the margin: these marks were not included, as their significance belongs to the context of a work process that is not present here. The same holds for (curved and pointed) brackets, bracketing a section as a whole: where the bracketed sections are edited here without preceding or following section(s) that are not bracketed, the brackets have been omitted. This is because such brackets have the function of delimiting the context and so are meaningful only where the context is also included. Also omitted are text deleted by Wittgenstein words and punctuation marks, which do not fit syntactically into the remark (this applies to crossings-out

in cases where Wittgenstein has neglected to cross out the whole text which belongs syntactically together with the deleted material, and to duplications of words and punctuation marks). Insertions and rearrangements were arranged or followed without this being indicated. When there was a date by a section this was included in the indication of source in standardized form. Text underlined once in the original is printed in *italics*; text underlined twice in the original is in SMALL CAPITALS. Passages underlined in the original with a wavy line (expressing doubts about the expression, cf. collected works, Vol. 3, p. 166) are here **underlined**; e.g. p. 5 "Das", p. 35 "₂".

Indentation: Wittgenstein has used indentations of various lengths for the separate paragraphs of his sections. The extent of the indentation is not rendered here; it would have been meaningful to do this in a context reaching beyond section and page. The first line of a section is printed here without indentation; all following paragraphs of a section are indented.

Orthography, Grammar and Punctuation: Wittgenstein's orthographic habits especially in the use of upper and lower case (e.g. "pointen"†i), in separations and runnings-together of words (e.g. "jeder so & sovielte"†ii) and historically or regionally restricted orthographies (like "c" for "z" and "k" in words of Latin origin, "stätig" for "stetig" and "alchemistisch" for "alchimistisch") have been respected. The ampersand "&" for "und" or "and" is retained. The use of "ss"/"ß" and of the apostrophe in genitives ("Goethe's") has been consistently corrected in accordance with modern usage. Extra punctuation marks have been supplied only where their absence would make reading difficult; and brackets were completed where in the original brackets are opened, but not closed. Quotation marks are printed in standardized form, ",", ';. Otherwise the punctuation has been left *as in the original*. All expansions at the level of *words* (i.e. expansions which constitute a new word) and at the level of *punctuation* are shown with pointed brackets, e.g. p. 7 "<>"; (orthographic) expansions and omissions below the level of words are not indicated. Indication is also made where an abbreviation has been expanded into the full word, as in the case of "B" into

"B<unyan>".

Page xvi

Variants: The remarks are printed inclusive of (undeleted) variants. Except

Page Break xvii

in cases like "(...) während die eigentlich(e) philosophische Überlegung (...)" (alternatives of "eigentliche" and "eigentlich": both versions in the main text, p. 53), the version written first is given in the main text, the other(s) however in footnotes. The various ways of marking variants ("[(...)]", "//(...)//" etc.) are not printed. Variants within variants are separated by "|". When variants required repetition of what was written only once in the original, this is indicated by "<(...)>". Alternative punctuation is also counted as a variant.

Page xvii

Graphics: The musical notation on p. 19 and the figures on pages 44 and 60 are facsimiles (reduced). In the original they are on lined paper; here the lines are suppressed for the sake of greater clarity. The facsimiles were produced by Michael Biggs.

Page xvii

Notes: Comments, explanations and textual notes are in end notes. "Unklar" means that the passage's content is unclear; "Nicht klar leserlich" means that the passage is not clearly legible.†

Page xvii

Appendix: The Appendix contains three lists: the first lists the sources of the remarks in the order in which they are published here; the second lists the sources alphanumerically; the third lists the beginnings of the remarks (with page references). The remarks which, in contrast to earlier editions, have been edited as whole sections are marked in the lists with an asterisk *.

Alois Pichler

Page Break xviii

Note by Translator

Page xviii

The present translation is a quite extensive revision of my original translation published in 1980. This is of course partly to take account of the new material included in Alois Pichler's revised edition, but there are other changes too. Some of these changes relate to my dissatisfaction with my earlier renderings; but there are others which are consequent on the somewhat different character of Mr Pichler's edition as compared with earlier editions.

Page xviii

Professor von Wright's earlier editions were intended for a readership broader than that to be expected for Wittgenstein's more technically philosophical works. They did not, partly for that reason, attempt to include the kind of textual detail that Mr Pichler has aimed at. *One* important feature of the newly included material is the detailed noting of the many variant readings that Wittgenstein included in his manuscripts and typescripts. In order even to begin any attempt to translate these variants, it was necessary to stick much more closely to the original grammatical structure of Wittgenstein's texts than I had thought appropriate in my earlier version. I have done this while still trying as far as possible to produce a text that reads like English and not a word for word representation into a weird "translatese".

Page xviii

Sometimes Wittgenstein's variant readings can be captured more or less satisfactorily; but by no means always. This is because the relative values of words which are roughly synonymous in German are not mirrored in the English counterparts of these words. In these cases there is no reason to suppose that Wittgenstein would have wished to present anything like the same variant readings had he been writing in English. It is important for the reader to bear this in mind.

Page xviii

I have added some footnotes of my own. These are numbered in small Roman numerals thus: i, ii, etc.

Page Break xix

Page xix

I wish to reiterate my gratitude to the people who gave me generous help with the earlier translation: Marina Barabas, Steven Burns, S. Ellis, Stephan Körner, Norman Malcolm, Heiki Nyman, Rush Rhees, Helen Widdess, Erika Winch and G. H. von Wright. I now wish to add my thanks to two people who have helped me with my revised version: Helen Geyer and Lars Hertzberg. Lars Hertzberg in particular took enormous pains to go through

the first draft of my revision. He made valuable suggestions, some of which I followed; though in other cases I obstinately stuck to my original versions.

University of Illinois at Urbana/Champaign

Peter Winch

November 1995

Page Break 1

Page Break 2

Culture and Value

Page 2

Page Break 3

Page 3

The Lieutenant†1 & I have already talked about all kinds of thing; a very nice man. He is able to get along with the greatest scoundrels & be friendly without compromising himself. If we hear a Chinese we tend to take his speech for inarticulate gurgling. Someone who understands Chinese will recognize *language* in what he hears. Similarly I often cannot recognize the *human being* in someone etc. Worked a bit, but without success. MS 101 7 c: 21.8.1914*

Page 3

There is no religious denomination in which so much sin has been committed through the misuse of metaphorical expressions as in mathematics. MS 106 58: 1929

Page 3

The human gaze has the power of making things precious; though it's true that they become more costly too. MS 106 247: 1929

Page 3

I myself still find my way of philosophizing new, & it keeps striking me so afresh, & that is why I have to repeat myself so often. It will have become part of the flesh & blood of a new generation & it will find the repetitions boring. For me they are necessary.--This method consists essentially in leaving the question of *truth* and asking about *sense* instead. MS 105 46 c: 1929*

Page 3

It's a good thing I don't let myself be influenced! MS 105 67 c: 1929

Page 3

A good simile refreshes the intellect. MS 105 73 c: 129

Page 3

It is hard to tell someone who is shortsighted how to get to a place. Because you can't say "Look at that church tower ten miles away over there and go in that direction.<"> MS 105 85 c: 1929

Page 3

Just let nature speak & acknowledge only *one* thing higher than nature, but not what others might think. MS 107 70 c: 1929

Page 3

You get tragedy where the tree, instead of bending, breaks. Tragedy is something unjewish. Mendelssohn is perhaps the most untragic of composers. Tragically holding on, defiantly holding on to a tragic situation in love always seems to me quite alien to my ideal. Does that mean my ideal

Page Break 4

is feeble? I cannot & *should not judge*. If it is feeble then it is bad. I believe that fundamentally I have a gentle & calm ideal. But may God protect my ideal from feebleness & mawkishness! MS 107 72 c: 1929*

Page 4

A new word is like a fresh seed thrown on the ground of the discussion. MS 107 82 [[sic, c?]]: 1929

Page 4

Each morning you have to break through the dead rubble afresh so as to reach the living, warm seed. MS 107 82 c: 1929

Page 4

With my full philosophical rucksack I can climb only slowly up the mountain of mathematics. MS 107 97 c: 1929

Page 4

Mendelssohn is not a peak, but a plateau. His Englishness. MS 107 98 c: 1929

Page 4

No one can think a thought for me in the way no one can don my hat for me. MS 107 100 c: 1929

Page 4

Anyone who listens to a child's crying with understanding will know that psychic forces, terrible forces, sleep within it, different from anything commonly assumed. Profound rage & pain & lust for destruction. MS 107 116 c: 1929

Page 4

Mendelssohn is like a man who is cheerful only when everything is cheerful anyway, or good only when everyone around him is good, & not self-sufficient like a tree that stands firmly in its place, whatever may be going on around it. I too am like that & tend to be so. MS 107 120 c: 1929

Page 4

My ideal is a certain coolness. A temple providing a setting for the passions without meddling with them. MS 107 130 c: 1929

Page 4

I often wonder whether my cultural ideal is a new one, i.e. contemporary, or whether it comes from the time of Schumann. At least it strikes me as a continuation of that ideal, though not the continuation that actually followed it then. That is to say, the second half of the 19th Century has been left out. This, I ought to say, has happened quite instinctively & and was not the result of reflection. MS 107 156 c: 10.10.1929

Page Break 5

If we think of the world's future, we always mean the place it will get to if it keeps going as we see it going now and it doesn't occur to us that it is not going in a straight line but in a curve & that its direction is constantly changing. MS 107 176 c: 24.10.1929

Page 5

I think good Austrian work (Grillparzer, Lenau, Bruckner, Labor) is particularly hard to understand. There is a sense in which it is *subtler* than anything else and its truth never leans towards plausibility. MS 107 184 c: 7.11.1929

Page 5

What is Good is Divine too. That, strangely enough, sums up my ethics.

Page 5

Only something supernatural can express the Supernatural.

MS 107 192 c: 10.11.1929

Page 5

You cannot lead people to the good; you can only lead them to some place or other; the good lies outside the space of facts.

MS 107 196: 15.11.1929

Page 5

I recently said to Arvid,†2 after I had been watching a very old film with him in the cinema: A modern film is to an old one as a present-day motor car is to one built 25 years ago. The impression it makes is just as ridiculous and clumsy & the way film-making has improved is comparable to the sort of technical improvement we see in cars. It is not to be compared with the improvement--if it's right to call it that--of an artistic style. It must be much the same with modern dance music too. A jazz dance, like a film, must be something that can be improved. What distinguishes all these developments from the formation of a *style* is that spirit plays no part in them.

Page 5

Today the difference between a good & a poor architect consists in the fact that the poor architect succumbs to every temptation while the good one resists it.

Page 5

I once said, & perhaps rightly: The earlier culture will become a heap of rubble & finally a heap of ashes; but spirits will hover over the ashes.

MS 107 229: 10.-11.1.1930

Page 5

One uses straw to try to stuff the cracks which show in the work of art's

Page Break 6

organic unity, but to quiet one's conscience one uses the *best* straw.

MS 107 242: 16.1.1930

Page 6

If anyone should think he has solved the problem of life & feels like telling himself everything is quite easy now, he need only tell himself, in order to see that he is wrong, that there was a time when this "solution" had not been discovered; but it must have been possible to live *then* too & the solution which has now been discovered appears in relation to how things were then like†a an accident. And it is the same for us in logic too. If there were a "solution to the problems of logic (philosophy)" we should only have to caution ourselves that there was a time when they had not been solved (and then too it must have been possible to live and think)--

MS 108 207: 29.6.1930

Page 6

Engelmann told me that when he rummages round at home in a drawer full of his own manuscripts, they strike him

as so glorious that he thinks they would be worth presenting to other people. (He said it's the same when he is reading through letters from his dead relations.) But when he imagines a selection of them published he said the whole business loses its charm & value & becomes impossible I said this case was like the following one: Nothing could be more remarkable than seeing someone who thinks himself unobserved engaged in some quite simple everyday activity. Let's imagine a theatre, the curtain goes up & and we see someone alone in his room walking up and down, lighting a cigarette, seating himself etc. so that suddenly we are observing a human being from outside in a way that ordinarily we can never observe ourselves; as if we were watching a chapter from a biography with our own eyes,--surely this would be at once uncanny and wonderful. More wonderful than anything that a playwright could cause to be acted or spoken on the stage. We should be seeing life itself.--But then we do see this every day & it makes not the slightest impression on us! True enough, but we do not see it from *that* point of view.--Similarly when E. looks at his writings and finds them splendid†b (even though he would not care to publish any of the pieces individually) he is seeing his life as God's work of art, & and as such it is certainly worth contemplating, as is every life & everything whatever. But only the artist can represent the individual thing so that it appears to us as a work of art; those manuscripts *rightly* lose their value if we contemplate them singly & in any case without *prejudice*, i.e. without being enthusiastic about them in

Page Break 7

advance. The work of art compels us--as one might say--to see it in the right perspective, but without art the object is a piece of nature like any other & the fact that *we* may exalt it through our enthusiasm does not give anyone the right to display it to us. (I am always reminded of one of those insipid photographs of a piece of scenery which is interesting to the person who took it because he was there himself, experienced something, but which a third party looks at with justifiable coldness; insofar as it is ever justifiable to look at something with coldness.<)>

But now it seems to me too that besides the work†a†b of the artist there is another through which the world may be captured sub specie æterni. It is--as I believe--the way of thought which as it were flies above the world and leaves it the way it is, contemplating it from above in its†c flight.†d†e

MS 109 28: 22.8.1930

Page 7

In Renan's *Peuple d'Israël* I read: "Birth, sickness, death, madness, catalepsy, sleep, dreams, all made an infinite impression and, even nowadays, it is given to only a small number to see clearly that these phenomena have causes within our constitution<.">†3 On the contrary there is absolutely no reason to marvel at such things; because they are such everyday occurrences. If primitive human beings *must* marvel at them, how much more so dogs & monkeys. Or is it being assumed that human beings suddenly awoke as it were & noticed these things which had always been there & were understandably amazed? Well, one might even assume something like this; not however that they became aware of these things for the first time, but rather that they suddenly began to marvel at them. But that too has nothing to do with their being primitive. Unless we call it primitive not to marvel at things, in which case it is precisely the people of today & Renan himself who are primitive, if he believes that scientific explanation could enhance wonderment.

As though today lightning were more commonplace or less astounding than 2000 years ago.

In order to marvel human beings--and perhaps peoples--have to wake up. Science is a way of sending them off to sleep again.

Page 7

I.e. it is simply false to say: of course, these primitive peoples *had* to marvel

Page Break 8

at everything. But perhaps right that these people *did* marvel at everything around them.--To think they had to marvel at them is a primitive superstition. (Like that of thinking that they *had* to fear all the forces of nature & that we of course do not have†a to fear. On the other hand experience may show that certain primitive tribes are very strongly inclined to fear natural phenomena.--But we cannot exclude the possibility that highly civilized peoples will become liable to this very same fear again & their civilization and the knowledge of science will†b not protect them from this. All the same it is true that the *spirit* in which science is carried on nowadays is not compatible with fear of this kind)

Page 8

What Renan calls the *bon sens précoce* of the semitic races (an idea that I †c already entertained a long time ago) is their *unpoetic* mentality, which heads straight for what is concrete. Which is characteristic of my philosophy. Things are right before our eyes†d, not covered by any veil.--This is where religion & art part company.

Page 8

Sketch for a Foreword†4

This book is written for those†e who are in sympathy with the spirit in which it is written.†f This spirit is, I believe, different from that of the†g prevailing European and American civilization. The spirit of this civilization the expression of which is the industry, architecture, music, of present day†h fascism & socialism, is a spirit that is alien & uncongenial†i to the author. This is not a value judgement. It is not as though I did not know that†j what today represents itself as architecture is not architecture & not†k as though he did not approach what is called modern music with the greatest mistrust (without understanding its language), but the disappearance of the arts does not justify a disparaging judgement on a whole segment of humanity. For in these times genuine & strong characters simply turn away from the field of the arts & towards other things & somehow the value of the individual finds expression. Not, to be sure, in the way it would at a time of Great Culture. Culture is like a great organization which assigns to each of its members his place, at which he

Page Break 9

can work in the spirit of the whole, and his strength can with a certain justice be measured by his success as understood within that whole. In a time without culture, however, forces are fragmented and the strength of the individual is wasted through the overcoming of opposing forces & frictional resistances; it is not manifest in the distance travelled but rather perhaps in the heat generated through the overcoming of frictional resistances. But energy is still energy & even if the spectacle afforded by this age is not the coming into being of a great work of culture in which the best contribute to the same great end, so much as the unimposing spectacle of a crowd whose best members pursue purely private ends, still we must not forget that the spectacle is not what matters.

Even if it is clear to me then that the disappearance of a culture does not signify the disappearance of human value but simply of certain means of expressing this value, still the fact remains that I contemplate the current of European civilization without sympathy, without understanding its aims if any. So I am really writing for friends who are scattered throughout the corners of the globe.

Page 9

It is all one to me whether the typical western scientist understands or appreciates my work since in any case he does not understand the spirit in which I write.

Page 9

Our civilization is characterized by the word progress. Progress is its form, it is not one of its properties that it makes progress. Typically it constructs. Its activity is to construct a more and more complicated structure. And even clarity is only a means to this end & not an end in itself.

For me on the contrary clarity, transparency, is an end in itself

I am not interested in erecting a building but in having the foundations of possible buildings transparently before me.

So I am aiming at something different than are the scientists & my thoughts move differently than do theirs.

Page 9

Each sentence that I write is trying to say the whole thing, that is, the same thing over and over again & it is as though they were†a views of one object seen from different angles.

Page Break 10

I might say: if the place I want to reach could only be climbed up to by a ladder, I would give up trying to get there. For the place to which I really have to go is one that I must actually be at already.

Anything that can be reached with a ladder does not interest me.

Page 10

One movement orders one thought to the others in a series, the other keeps aiming at the same place.

Page 10

One movement constructs & takes (in hand) one stone after another,†a the other keeps reaching for the same one.

Page 10

The danger in a long foreword is that the spirit of a book has to be evident in the book itself & cannot be described. For if a book has been written for only a few readers that will be clear just from the fact that only a few understand it. The book must automatically separate those who understand it & those who do not. The foreword too is written just for such as†b understand the book.

Telling someone something he does not understand is pointless, even if you add that he will not be able to

understand it. (That so often happens with someone you love.)

If you do not want certain people to get into a room, put a lock on it for which they do not have the key. But it is senseless to talk with them about it, unless you want them all the same to admire the room from outside!

The decent thing to do is: put a lock on the doors that attracts only those†c who are able to open it & is not noticed by the rest.

But it's alright to say that the book in my opinion has nothing to do with the progressive civilization of Europe & America.

That this civilization is perhaps an environment necessary for its spirit but that they have different aims.

Everything ritualistic (everything that, as it were, smacks of the high priest) is strictly to be avoided because it straightaway turns rotten†d.

Of course a kiss is a ritual too & it isn't rotten; but no more ritual is permissible than is as genuine as a kiss.

Page Break 11

Page 11

It is a great temptation to want to make the spirit explicit.

MS 109 204: 6-7.11.1930

Page 11

When you bump against the limits of your own decency it is as though a whirlpool of thoughts is generated, (&) an endless regress: you may *say* what you like, it gets you no further. MS 109 212: 8.11.1930

Page 11

I am reading Lessing (on the Bible): "Add to this the verbal clothing and the style.... absolutely full of tautologies, but of a kind to exercise one's wits by seeming sometimes to say something different while really saying the same thing, and at other times seeming to say the same thing while at bottom meaning, or being capable of meaning, something different..."†5 MS 110 5:12.12.1930

Page 11

If I do not quite know how to begin a book that is because something is still unclear. For I should like to begin with the original data of philosophy, written & spoken sentences, with books as it were
And here we encounter the difficulty of "Everything is in flux". And perhaps that is the very point at which to begin. MS 110 10: 13.12.1930

Page 11

If someone is merely ahead of his time, it will catch him up one day.
MS 110 11: 25.12.1930

Page 11

Music, with its few notes & rhythms, seems to some people a primitive art. But only its surface†a is simple, while the body which makes possible the interpretation of this manifest content has all the infinite complexity that is suggested in the external forms of other arts & which music conceals. In a certain sense it is the most sophisticated art of all.

Page 11

There are problems I never tackle, which do not lie in my path or belong to my world. Problems of the intellectual world of the West which Beethoven (& perhaps Goethe to a certain extent) tackled & wrestled with but which no philosopher has ever confronted (perhaps Nietzsche passed close to them)
And perhaps they are lost to western philosophy, that is there will be no one there who experiences and so can describe the development of this culture as an epic. Or more precisely it just is no longer an epic, or is one

Page Break 12

only for someone who observes it from outside & perhaps Beethoven did this with prevision (as Spengler hints in one place) It might be said that civilization can only have its epic poet in advance. Just as one can only foresee one's own death and describe it as something lying in the future, not report it as it happens. So it might be said: If you want to see the epic of a whole culture written†a you will have to seek it in the works of its greatest figures and hence seek it at a time when the end of this culture can only be *foreseen*, for later there is no one there any more to describe it. So it is not to be wondered at that it should be written in the dark language of prevision†b & intelligible only to the very few.

Page 12

But I do not get to these problems at all. When I "have done with the world" I have created an amorphous (transparent) mass & the world in all its variety is left on one side like an uninteresting lumber room.

Or perhaps more precisely: the whole outcome of the entire work is for the world to be set on one side. (A throwing-into-the-lumber-room of the whole world)

Page 12

In this world (mine) there is no tragedy & with that all the endlessness that gives rise to tragedy (as its result†c) is lacking

It is as though everything were soluble in the ether;†d there are no harnesses.

This means that hardness & conflict do not become something splendid†e but a *defect*.

Page 12

Conflict is dissipated in much the same way as is the tension of a spring in a mechanism that you melt (or dissolve in nitric acid). In this†f solution tensions no longer exist. MS 110 12: 12.-16.1.1931

Page 12

If I say that my book is meant for only a small circle of people (if that can be called a circle) I do not mean to say that this circle is in my view the élite of mankind but it is the circle to which†g I turn (not because they are better or worse than the others but) because they form my cultural circle, as it

Page Break 13

were my fellow countrymen in contrast to the others who are *foreign* to me.

MS 110 18: 18.1.1931

Page 13

The limit of language manifests itself in the impossibility of describing the fact that corresponds to (is the translation of) a sentence without simply repeating the sentence.

Page 13

(We are involved here with the Kantian solution of the problem of philosophy.)

MS 110 61: 10.2.1931

Page 13

Can I say that drama has its own time which is not a segment of historical time. I.e. I can speak of earlier and later within it but there is *no sense* to the question whether the events in it took place, say, before or after Caesar's death.

MS 110 67: 12.2.1931

Page 13

The charming difference in temperature between the parts of a human body. MS 153a 4v: 10.5.1931

Page 13

It is humiliating having to present oneself as an empty tube only inflated by the mind.

MS 153a 12v: 1931

Page 13

No one likes having offended another person; that is why it does everyone good when the other person doesn't show that he has been offended. Nobody likes being confronted by a wounded spaniel. Remember that. It is much easier patiently--& tolerantly†i--to avoid the person that offended you than to approach him as a friend. You need courage too for that.

MS 153a 18v 1931

Page 13

To treat well somebody who does not like you requires not just great good nature but great *tact* too.

MS 153a 29v: 1931

Page 13

We are struggling with language.

Page 13

We are engaged in a struggle with language.

MS 153a 35r: 1931

Page 13

Compare the solution of philosophical problems with the fairy tale gift that seems magical in the enchanted castle and if it is looked at in daylight

Page Break 14

is nothing but an ordinary bit of iron (or something of the sort).

MS 153a 35v: 1931

Page 14

A thinker is very similar to a draughtsman. Who wants†a to represent all the interconnections. MS 153a 90v: 1931

Page 14

Pieces of music composed at the keyboard, those by thinking with the pen & those composed just with imagined

sounds must be of quite a different kind†b and make quite different kinds of impression.

I am sure that Bruckner composed just in his head, imagining the orchestra playing, Brahms with his pen. Of course this is an oversimplification. But it does highlight *one* feature. MS 153a 127v: 1931

Page 14

A tragedy might really always start with the words: "Nothing at all would have happened, had it not been that..."

Page 14

(Had he not been caught in the machine by a corner of his clothing?)

Page 14

But isn't it a one-sided view of tragedy to think of it merely as showing, that an encounter can decide one's whole life.

Page 14

I think today there could be a form of theatre played in masks. The characters would be just stylized human beings.†c†6 In Kraus's writings this can be clearly seen. His pieces could be, or should be, performed in masks. Of course this goes with a certain abstractness in these works. And masked theatre, as I believe, is in any case the expression of an intellectual character. Perhaps (too) for this reason only Jews will be attracted to this theatre. MS 153a 128v: 1931

Frida Schanz:

Foggy day. Grey autumn haunts us.

Laughter seems tainted;

Page Break 15

the world is mute today,
as though last night it died.
In the red-gold hedge
are brewing fog dragons;
and sleeping lies the day.
The day will not awaken.

(...)

I took the poem on the previous page from a "Rösselsprung"†i in which of course the punctuation was not shown. So I do not know if the words "Foggy day" form the title, or belong to the first line, as I have written it. And it is remarkable how trivial the poem sounds if it does not begin with "Foggy day" but with "Grey". This changes the rhythm of the *whole* poem.†a MS 153a 136r: 1931

Page 15

What you have achieved cannot mean†b more to others than to you.

Page 15

As much (as) it has cost you, that is what they will pay.

MS 153a 141r: 1931

Page 15

The Jew is a desert region under whose thin layer of rock lies the molten lava of spirit. MS 153a 160v: 1931

Page 15

Grillparzer: "How easy it is to move about in broad distant regions, how hard to grasp what is individual & near at hand..." MS 153b 3r: 1931

Page 15

How should we feel if we had never heard of Christ?

Should we feel left alone in the dark?

Do we not feel like that only in the way a child doesn't when he knows there is someone in the room with him?

Religious madness is madness springing from irreligiousness. MS 153b 29r: 1931

Page 15

I look at the photographs of Corsican brigands and reflect: these faces are too hard & mine too soft for Christianity to be able to write on them. The

Page Break 16

faces of the brigands are terrible to behold & yet they are certainly no more distant from a good life & are simply situated on a different side of it than am I. MS 153b 39v: 1931

Page 16

A confession has to be part of one's new life.

MS 154 1r: 1931

Page 16

I never more than half succeed in expressing what I want to express. Indeed not even so much,†7 but perhaps only one tenth. That must mean something. My writing is often nothing but "stammering".

MS 154 1v: 1931

Page 16

The saint is the only Jewish "genius". Even the greatest Jewish thinker is no more than talented. (Myself for instance.)

Page 16

I think there is some truth in my idea that I am really only reproductive in my thinking. I think I have never *invented* a line of thinking but that it was always provided for me by someone else & I have done no more than passionately take it up for my work of clarification. That is how Boltzmann Hertz Schopenhauer Frege, Russell, Kraus, Loos Weininger Spengler, Sraffa†8 have influenced me. Can one take Breuer & Freud as an example of Jewish reproductive thinking?--What I invent are new *comparisons*.

Page 16

At the time I modelled the head for Drobil too the stimulus was essentially a work of Drobil's & my work was again really one of clarification. I believe that what is essential is for the activity of clarification to be carried out with COURAGE; without this it becomes a mere clever game.

Page 16

The Jew must in a real sense "make nothing his business".†i But for him especially this is particularly hard because he, as it were, has nothing. It is much harder to be poor voluntarily if you *can't help* being poor, than when you might also be rich.

Page 16

It might be said (rightly or wrongly) that the Jewish mind is not in a

Page Break 17

position to produce even so much as a tiny blade of grass or flower but that its way is to make a drawing of the blade of grass or the flower that has grown in the mind of another & then use it to sketch a comprehensive picture. This is not to allege a vice & everything is all right as long as what is being done is quite clear. Danger arises only when someone confuses the nature of a Jewish work with that of a non-Jewish work & especially when the author of the former does so himself, as he so easily may. ("Doesn't he look as proud as though he were being milked himself."†9<>

It is typical of the Jewish mind to understand someone else's work better than he understands it himself.

Page 17

When I have had a picture suitably framed or have hung it in the right surroundings I have often caught myself being as proud as though I had painted the picture. Actually that's not right: not "as proud as though I had painted it" but as proud as though I had helped to paint it, as though I had so to speak painted a little bit of it. It is as if an exceptional arranger of grasses were at last to think that he too had produced at least a quite tiny blade of grass himself. Whereas it ought to be clear to him that his work lies in a different region altogether.

The process through which even the tiniest & meanest blade of grass comes into being is quite foreign & unknown to him.

Page 17

A picture of a complete apple tree, however accurate, in a certain sense resembles it infinitely less than does the smallest daisy. And in this sense a symphony by Bruckner is infinitely more closely related to a symphony from the heroic period than is one by Mahler. If the latter is a work of art it is one of a *totally* different sort. (But this observation itself is actually Spenglerian.)

Page 17

Anyway when I was in Norway during the year 1913-14 I had some thoughts of my own, or so at least it seems to me now. I mean that I have the impression of having given birth to new lines of thinking at that time (But perhaps I am mistaken). Whereas now I seem just to apply old ones.

MS 154 15v: 1931

Page 17

There is something Jewish in Rousseau's character.

MS 154 20v: 1931

Page 17

If it is said on occasion that (someone's) philosophy is a matter of temperament, there is some truth in this. A preference for certain comparisons is something we call a matter of temperament & far more disagreements

rest on this than appears at first sight.†a

"Look on this wart†b as a regular limb of your body!" Can one do that, to order?

Do I have the power to decide at will to have, or not to have, a certain ideal conception of my body?

Within the history of the peoples of Europe the history of the Jews is†10 not treated so circumstantially as their intervention in European affairs would actually merit, because within this history they are experienced as a sort of disease, anomaly, & nobody wants to put a disease on the same level as normal life†c [[sic . ?]]

We may say: this bump can be regarded as a limb of one's body only if our whole feeling for the body changes (if the whole national feeling for the body changes). Otherwise the best we can do is *put up with it*.

You may expect an individual to display this sort of tolerance or even to disregard such things; but you cannot expect this of a nation since it is only a nation by virtue of not disregarding such things. I.e. there is a contradiction in expecting someone to retain the original aesthetic feeling for his body & also to make the swelling welcome.

Power & possession are not the *same* thing. Even though possession also gives us power. If Jews are said not to have any sense for possession that is presumably compatible with their liking to be rich; for money is for them a particular sort of power not possession. (I should for instance not like my people to be poor, since I wish them to have a certain power. Naturally I wish them to use this power properly too.)

There is definitely a certain kinship between Brahms & Mendelssohn; but I do not mean that shown by the individual passages in Brahms's works that are reminiscent of passages in Mendelssohn but the kinship of which I am speaking could be expressed by saying that Brahms does with complete rigour what Mendelssohn did half-rigorously. Or: Brahms is often Mendelssohn without the flaws.



†11 That must be the end of a theme which I cannot place†i. It occurred to me today as I was thinking about my work in philosophy & said to myself: "I destroy, I destroy, I destroy--" MS 154 21v: 1931

It has sometimes been said that the Jews' secretive & cunning nature is a result of their long persecution. That is certainly untrue; on the other hand it is certain that, despite this persecution, they continue to exist only because they have the inclination towards this secretiveness. As we may say that such & such an animal has escaped extinction only because it has the possibility or capability of concealing itself. Of course I do not mean that one should commend this ability for such a reason, not by any means.

In Bruckner's music nothing is left of the long & slender (nordic?) face of Nestroy, Grillparzer, Haydn, etc. but it has in full measure a round full (alpine?) face even purer in type than was Schubert's.

The power of language to make everything look the same which appears in its crassest form in the *dictionary* & which makes it possible to personify *time*, something which is no less remarkable than would have been making

divinities of the logical constants.

MS 154 25v: 1931

Page 19

A beautiful garment that changes (coagulates as it were) into worms &

Page Break 20

serpents if its wearer smugly smartens himself up†12 in it in the mirror. MS 155 29r: 1931

Page 20

The pleasure I take in my thoughts is pleasure in my own strange life. Is this joi de vivre? MS 155 46r: 1931

Page 20

By the way in†a the old conception--roughly that of the (great) western philosophers--there were two†b sorts of problem in the scientific sense: essential, great, universal, & inessential, as it were accidental, problems. Our conception on the contrary is that there is no *great* essential problem in the scientific sense.†i MS 110 200: 22.6.1931

Page 20

Structure & feeling in music. Feelings accompany our grasp of a piece of music as they accompany events in our life. MS 110 226: 25.6.1931

Page 20

Labor's seriousness is a very late seriousness. MS 110 231 c: 29.6.1931

Page 20

Talent is a spring from which fresh water is constantly flowing. But this spring loses its value if it is not used†c in the right way. MS 110 238: 30.6.1931

Page 20

"What a sensible man knows is hard to know." Does Goethe's contempt for laboratory experiment and his exhortation to go out into uncontrolled nature & learn from that, does this have some connection with the idea that a hypothesis (wrongly conceived) is already a falsification of the truth? And with the beginning I am now thinking of for my book which might consist of a description of nature?†d MS 110 257: 2.7.1931

Page 20

If people find a flower or an animal ugly they always have an impression as though they were artifacts. "It looks like a ..." they say. This sheds light on the meaning of the words "ugly" & "beautiful". MS 110 260 c: 2.7.1931

Page Break 21

Page 21

Labor, when he writes good music, is absolutely unromantic. That is a very remarkable & significant indication. MS 111 2c: 7.7.1931

Page 21

Reading the Socratic dialogues, one has the feeling: what a frightful waste of time! What's the point of these arguments that prove nothing & clarify nothing. MS 111 55: 30.7.1931

Page 21

The story of Peter Schlemihl†13 should, it seems to me, go†a like this: He makes over his soul to the Devil for money. Then he repents it & now the Devil demands his shadow as ransom. But Peter Schlemihl still has a choice between giving the Devil his soul or sacrificing along with his shadow life in community with human beings. MS 111 77:11.8.1931

Page 21

In Christianity it is as though God said to human beings: Don't act a tragedy, that is to say, don't enact heaven & hell on earth, heaven & hell are *my* affair. MS 111 115: 19.8.1931

Page 21

Spengler could be better understood if he said: I am *comparing* different periods of culture with the lives of families; within the family there is a family resemblance, while you will also find a resemblance between members of different families; family resemblance differs from the other sort of resemblance in such & such ways etc.. What I mean is: We have to be told the object of comparison, the object from which this approach is derived, so that prejudices do not constantly slip into the discussion. Because then we shall willy nilly ascribe what is true†b of the prototype of the approach†c to the object to which we are applying the approach as well; & we claim "*it must always be...*" This comes about because we want to give the prototype's characteristics a foothold in the approach. But since we confuse prototype & object we find ourselves dogmatically conferring on the object properties which only the prototype necessarily possesses. On the other hand we think the approach will lack the†d generality we want to give

if it really holds only of the one case. But the prototype must just be presented for what it is; as characterizing the whole approach and determining its form. In this way it stands at the head & is generally valid by virtue of determining the form of approach, not by virtue of a claim that everything which is true only of it

Page Break 22

holds for all the objects to which the approach is applied.

One should thus always ask when exaggerated dogmatic claims are made: What is actually true in this. Or again: In what case is that actually true MS 111 119: 19.8.1931

Page 22

From Simplicissimus: riddles of technology.

(Picture: two professors in front of a bridge under construction) Voice from above: "Fotch it dahn--coom on--fotch it dahn A tell tha--we'll turn it t'other rooad sooin!"†i --"It really is quite incomprehensible, my dear colleague, how such complicated & precise work can be carried out in this language." MS 111 132: 23.8.1931

Page 22

We keep hearing the remark that philosophy really does not progress, that we are still occupied with the same philosophical problems as were the Greeks. Those who say this however don't understand why it is so.†a It is because our language has remained the same & keeps seducing us into asking the same questions. As long as there is still a verb 'to be' that looks as though it functions in the same way as 'to eat' and 'to drink', as long as we still have the adjectives 'identical', 'true', 'false', 'possible', as long as we continue to talk of a river of time & an expanse of space, etc., etc., people will keep stumbling over the same cryptic difficulties & staring at something that no explanation seems capable of clearing up.

And this satisfies besides a longing for the supernatural†b for in so far as people think they can see the "limit of human understanding", they believe of course that they can see beyond it.

Page 22

I read: "philosophers are no nearer to the meaning of 'Reality' than Plato got;..." What a singular†c situation. How singular then that Plato has been able to get†d even as far as he did! Or that we could get no further afterwards! Was it because Plato was so clever? MS 111 133: 24.8.1931

Page Break 23

Kleist wrote somewhere†14 that what the poet would most of all like to be able to do, would be to convey thoughts in themselves†a without words. (What a strange avowal.) MS 111 173: 13.9.1931

Page 23

It is often said that a new religion brands the gods of the old one as devils. But in reality they have presumably by that time already become devils. MS 111 180:13.9.1931

Page 23

The works of the great masters are stars†b which rise and set around us. So the time will come again for every great work that is now in the descendent. MS 111 194: 13.9.1931

Page 23

(Mendelssohn's music, when it is flawless, consists of musical arabesques. That is why we feel embarrassed at every lack of rigour in his work.)

Page 23

In Western Civilization the Jew is always being measured according to calibrations which do not fit him. That the Greek thinkers were neither philosophers in the western sense, nor scientists in the western sense, that those who took part in the Olympic Games were not sportsmen & fit into <no> western occupation, is clear to many people. But it is the same with the Jews too†c

And insofar as the words of our <language> seem to us the only possible standards of measurement we are always doing him†d injustice. And he is†e first overestimated then underestimated. In this context Spengler is quite right not to classify Weininger with the western philosophers.†f†15

Page 23

Nothing we do can be defended definitively. But only by reference to something else that is established.

I.e. no reason can be given why you should act (or should have acted) *like this*, except that by doing so you bring about such and such a situation, which again you have to *accept* as an aim. MS 111 195: 13.9.1931

Page 23

The inexpressible (what I find enigmatic & cannot express) perhaps provides the background, against which whatever I was able to express acquires meaning. MS 112 1: 5.10.1931

Page Break 24

Work on philosophy--like work in architecture in many respects--is really more work†a on oneself. On one's own conception. On how one sees things. (And what one expects of them.) MS 112 46: 14.10.1931

Page 24

The philosopher easily gets into the position of an incompetent manager who, instead of doing his *own* work & simply seeing to it†b that his employees do theirs properly takes over their work & so finds himself one day overloaded with other people's work, while the employees look on and criticize him. MS 112 60: 15.10.1931

Page 24

The idea is worn out by now & no longer usable. (I once heard Labor make a similar remark about musical ideas.) In the way silver paper, once crumpled, can never quite be smoothed out again. Nearly all my ideas are a bit crumpled. MS 112 76: 24.10.1931

Page 24

I really do think with my pen, for my head often knows nothing of what my hand is writing.

Page 24

(Philosophers are often like little children who first scribble some marks on a piece of paper at random and now†c ask the grown-up "what's that?"--It happened like this: The grown-up had often drawn something for the child & said: "this is a man", "this is a house" etc. And now the child makes some marks too and asks: and what's *this* then?" MS 112 114: 27.10.1931

Page 24

Ramsey was a bourgeois thinker. I.e. he thought with the aim of clearing up the affairs of some particular community. He did not reflect on the essence of the state--or at least he did not like doing so--but on how *this* state might reasonable be organized. The idea that this state might not be the only possible one partly disquieted him and partly bored him. He wanted to get down as quickly as possible to reflecting on the foundations--of *this* state. This was what he was good at & what really interested him; whereas real philosophical reflection disquieted him until he put its result (if it had one) on one side as trivial. MS 112 139: 1.11.1931

Page Break 25

A curious analogy could be based on the fact that the eye-piece of even the hugest telescope cannot be bigger†a than our eye. MS 112 153: 11.11.1931

Page 25

Tolstoy: the meaning (importance) of something lies in its being something everyone can understand. That is both true & false. What makes the object hard to understand--if it's significant, important--is not that you have to be instructed in abstruse matters in order to understand it, but the antithesis between understanding the object & what most people *want* to see. Because of this precisely what is most obvious may be what is most difficult to understand. It is not a difficulty for the intellect but one for the will that has to be overcome. MS 112 221: 22.11.1931

Page 25

Someone who teaches philosophy nowadays gives his pupil foods, not†b because they are to his taste, but in order to change his taste. MS 112 223: 22.11.1931

Page 25

I must be nothing more than the mirror in which my reader sees his own thinking with all its deformities & with this assistance can set it in order. MS 112 225: 22.11.1931

Page 25

Language sets everyone the same traps; it is an immense network of well kept†c wrong turnings. And hence we see one person after another walking down the same paths & we know in advance the point at which they will branch off, at which they will walk straight on without noticing the turning, etc., etc. So what I should do is erect signposts at all the junctions where there are wrong turnings, to help people past the danger points.

Page 25

What Eddington says about the 'direction of time' & the principle of entropy amounts to saying that time would reverse its direction if people began one day to walk backwards. If you like you can by all means call it that; but then you must be clear in your mind that you have said no more than that people have changed the direction in which they walk. MS 112 231: 22.11.1931

Page Break 26

Someone divides human beings into buyers & sellers, & forgets that buyers are sellers as well. If I remind him of this, †a is his grammar changed? MS 112 232: 22.11.1931

Page 26

The real achievement of a Copernicus or a Darwin was not the discovery of a true theory but of a fertile new point of view. MS 112 233: 22.11.1931

Page 26

I believe that what Goethe was really seeking was not a physiological but a psychological theory of colours. MS 112 255: 26.11.1931

Page 26

Philosophers who say: "after death a timeless state will supervene", or "at death a timeless state supervenes" & do not notice that they have used in a temporal sense the words "after" & "at" & "supervenes" & that temporality is embedded in their grammar. MS 113 80: 29.2.1932

Page 26

Remember the impression made by good architecture, that it expresses a thought. One would like to respond to it too with a gesture. MS 156a 25r: ca. 1932-1934

Page 26

Don't play with what lies deep in another person! MS 156a 30v: ca. 1932-1934

Page 26

The face is the soul of the body. MS 156a 49r: ca. 1932-1934

Page 26

One cannot view †b one's own character from outside any more than one's *own handwriting*. I have a one-sided relation to my handwriting that prevents me from seeing & comparing it with the writing of others on the same footing. MS 156a 49v: ca. 1932-1934

Page 26

In art it is hard to say anything, that is as good as: saying nothing. MS 156a 57r: ca. 1932-1934

Page Break 27

My thinking, like everyone's, has sticking to it the shrivelled husks †a of my earlier (withered) thoughts. MS 156a 58v: ca. 1932-1934

Page 27

The *strength of the musical thinking* in Brahms. MS 156b 14v: ca. 1932-1934

Page 27

The various plants & their *human* character: rose, ivy, grass, oak, apple tree, corn palm. Compared with the diverse character of words MS 156b 23v: ca. 1932-1934

Page 27

If one wanted to characterize the essence of Mendelssohn's music one could do it by saying that there is perhaps no music by Mendelssohn that is hard to understand. MS 156b 24v: ca. 1932-1934

Page 27

Every artist has been influenced by others & shows (the) traces of that influence in his works; but what we get from him is all the same only his own personality †b. What is inherited from others can be nothing but egg shells. We should treat the fact of their presence with indulgence but they will not give us Spiritual nourishment.

Page 27

It seems to me (sometimes) as though I were already †c philosophizing with toothless gums & as though I took speaking without teeth for the right way, the more worthwhile way. I detect something similar in Kraus. Instead of my recognizing it as a deterioration. MS 156b 32r: ca. 1932-1934

Page 27

If someone says, let's suppose, "A's eyes have a more beautiful expression than B's", then I want to say that he certainly does not mean by the word beautiful what is common to everything that we call "beautiful". Rather he is playing a game with this word that has quite narrow bounds. But what shows this? Did I have in mind some particular restricted explanation of the word "beautiful"? Certainly not.--But perhaps I shall not even want to compare the beauty of expression in a pair of eyes with the beauty in the shape of a nose.

Page Break 28

Page 28

Indeed we might perhaps say: If a language had two words so that there was no indication of anything common to these cases I should have no trouble taking one of these two specialized words for my case & nothing would be lost from the sense of what I wanted to say.

One might say: how would I explain the word 'rule' or 'plant' in the particular case then? that will show 'what I mean by it'.

Suppose I had said: "the gardener raises very beautiful plants in this greenhouse". I want to communicate something to my hearer with this & the question arises: for this does he have to know what is common to everything that we call "plant"? No. I could quite well have given him the explanation for the case in hand by means of a few examples or a few pictures.

In the same way if I say: "I will just explain the rules of this game to you", do I presuppose that the other knows everything that is common to what we call "rule"? MS 145 14r: Autumn 1933*

Page 28

If I say A. has beautiful eyes I may be asked: What do you find beautiful about his eyes & perhaps I will answer: the almond shape, the long lashes, the delicate lids.

What do these eyes have in common with a Gothic church that I also find beautiful? Am I to say they make a similar impression on me? What if I said: what they have in common is that in both cases my hand is tempted to draw them? That at any rate would be a *narrow definition* of the†a beautiful.

It will often be possible to say: ask what your reasons are for calling something good or beautiful & the particular grammar of the word "good" in this case will be apparent. MS 145 17v: 1933

Page 28

I believe I summed up where I stand in relation to philosophy when I said: really one should write philosophy only as one *writes a poem*. That, it seems to me, must reveal how far my thinking belongs to the present, the future, or the past. For I was acknowledging myself, with these words, to be someone who cannot quite do what he would like to be able to do. MS 146 25v: 1933-1934

Page 28

If you use a trick in logic, whom can you be tricking but yourself? MS 146 35v: 1933-1934

Page Break 29

Composers' names. Sometimes it is the method of projection that we treat as given. When we, say, ask What name would hit off this person's character But sometimes we project the character into the name & treat that as given. Thus we get the impression that the great masters we know so well have just the names that suit their work. MS 146 44v: 1933-1934

Page 29

If someone prophesies that the generation to come will take up these problems & solve them that is usually a sort of wishful thinking, a way of excusing oneself for what one should have accomplished & hasn't. A father would like his son to achieve what he has not achieved so that the task he left unresolved should find a resolution nevertheless. But his son is faced with a new task. I mean: the wish that the task should not remain unfinished disguises itself as a prediction that it will be taken further by the next generation. MS 147 16r: 1934

Page 29

The overwhelming *skill* in Brahms. MS 147 22r: 1934

Page 29

If I say: "that is the only thing that is really seen" I point in front of me. If I were to point sideways or behind me however--at things that I did not see--this pointing would lose all its sense for me. That means, though that my pointing in front of me is not contrasted with anything.

(Someone who is in a hurry will when sitting in a car push involuntarily, even though he may tell himself that he is not pushing the car at all.) MS 157a 2r: 1934*

Page 29

By the way, in my artistic activities I have merely *good manners*. MS 157a 22v: 1934

Page 29

In the days of silent films all the classics were played with the films, except Brahms & Wagner. Not Brahms because he is too abstract. I can imagine an exciting scene in a film accompanied with music by Beethoven or Schubert & might gain some sort of understanding of the music from the film. But not an understanding of music by Brahms. Bruckner on the other hand does go with a film. MS 157a 44v: 1934 or 1937

Page 29

The queer resemblance between a philosophical investigation (perhaps especially in mathematics <)> and one in

aesthetics. (E.g. what is bad about this garment, how it should be, etc..) MS 116 56: 1937

Page Break 30

The *edifice of your pride* has to be dismantled. And that means frightful work. MS 157a 57r: 1937

Page 30

In one day you can experience the horrors of hell; that is plenty of time. MS 157a 57r: 1937

Page 30

There is a big difference between the effect of a script that you can read fluently & one that you can write but not decipher†a *easily*. The thoughts are enclosed,†16 as in a casket. MS 157a 58r: 1937

Page 30

The greater "purity" of objects that do not affect the senses, numbers for instance. MS 157a 62v: 1937

Page 30

If you offer a sacrifice & then are conceited about it, you will be cursed along with your†b sacrifice. MS 157a 66v c: 1937

Page 30

The light shed by work is a beautiful light, but it only shines with real beauty if it is illuminated by yet another light. MS 157a 67v c: 1937

Page 30

"Yes, that's how it is," you say, "because that's how it *must* be!"

Page 30

(Schopenhauer: the real life span of the human being is 100 years.)

"Of course, it must be like that!" It is as though you have understood a creator's *purpose*. You have understood the *system*.

You do not ask yourself 'How long do human beings actually live then?', that seems now a superficial matter; whereas you have understood something more profound. MS 157b 9v: 1937

Page 30

The†17 only way namely for us†c to avoid prejudice†18 --or vacuity in our claims, is to posit†d the ideal as what it is, namely as an object of comparison--a measuring rod as it were--within our way of looking at things, & not†e as a preconception to which everything must†f conform. This namely is†g the dogmatism into which philosophy†h can so easily degenerate.

Page Break 31

But then†19 what is the relation between an approach like Spengler's & mine?

Injustice in Spengler: The ideal loses none of its dignity if it is posited as the principle determining the form of one's approach. A good unit of measurement.-- --†20 MS 157b 15v: 1937

Page 31

Slept a bit better. Vivid dreams. A bit depressed; weather & state of health.

The solution of the problem you see in life is a way of living which makes what is problematic disappear.

The fact that life is problematic means that your life does not fit life's shape. So you must change your life, & once it fits the shape, what is problematic will disappear.

But don't we have the feeling that someone who doesn't see a problem there is blind to something important, indeed to what is most important of all?

Wouldn't I like to say he is living aimlessly--just blindly like a mole as it were; & if he could only see†a, he would see the problem?

Or shouldn't I say: someone who lives rightly does not experience the problem as *sorrow*, hence not after all as a problem, but rather as joy, that is so to speak as a bright halo round his life, not a murky background. MS 118 17r c: 27.8.1937*

Page 31

Almost in the same way as earlier physicists are said to have found suddenly that they had too little mathematical understanding to be able to master physics; we may say that young people today are suddenly in the position that ordinary common sense no longer suffices to meet the strange demands life makes. Everything has become so intricate that for its mastery†b an exceptional degree of understanding is required. For it is not enough any longer to be able to play the game well; but the question is again and again: what sort of game is to be played now anyway?†c MS 118 20r: 27.8.1937

Page 31

There is much that is excellent in Macaulay's essays; only his *value judgements* on people are tiresome, &

superfluous. One would like to say to him: stop gesticulating! & just say what you have to say. MS 118 21v:
27.8.1937

Page Break 32

Ideas too sometimes fall from the tree before they are ripe.

MS 118 35r c: 29.8.1937

Page 32

In philosophizing it is important for me to keep changing my position, not to stand too long on *one* leg, so as not to get stiff.

Like someone on a long up-hill climb who walks backwards for a while to revive himself, stretch some different muscles.

MS 118 45r c: 1.9.1937

Page 32

Caught a bit of a chill & unable to think. Ghastly weather.--

Christianity is not a doctrine, not, I mean, a theory about what has happened & will happen to the human soul, but a description of something that actually takes place in human life. For 'recognition of sin' is an actual occurrence & so is despair & so is redemption through faith. Those who speak of it (like Bunyan), are simply describing what has happened to them; whatever gloss someone may want to put on it!

MS 118 56r c: 4.9.1937*

Page 32

When I imagine a piece of music, something I do every day & often, I--always I think--rhythmically grind my upper & lower front teeth together. I have noticed it before but usually it takes place quite unconsciously. Moreover it's as though the notes in my imagination were produced by this movement.

I think this way of hearing music in the imagination may be very common. I can of course also imagine music without moving my teeth, but then the notes are much more blurred, much less clear, less pronounced.

MS 118 71v c: 9.9.1937

Page 32

If certain graphic propositions for instance are laid down for human beings as dogmas governing thinking, namely in such a way that opinions are not thereby determined, but the *expression* of opinions†a is completely controlled, this will have a very strange effect. People will live under an absolute, palpable tyranny, yet without being able to say they are not free.†i I think the Catholic Church does something like this. For dogma is expressed in the form of an assertion & is unshakable, & at the same time any practical

Page Break 33

opinion can be made to accord with it; admittedly this is easier in some cases, more difficult in others. It is not a *wall* setting limits to belief, but like a *brake* which in practice however serves the same purpose;†a†b almost as though someone attached a weight to your foot to limit your freedom of movement.†c This is how dogma becomes irrefutable & beyond the reach of attack.

MS 118 86v: 11.9.1937

Page 33

With thinking too there is a time for ploughing & a time for harvesting.

It gives me satisfaction to write *a lot* every day. This is childish but that's how it is. MS 118 87r c: 11.9.1937*

Page 33

If I am thinking just for myself without wanting to write a book, I jump about all round the topic; that is the only way of thinking that is natural to me. Forcing my thoughts into an ordered sequence is a torment for me. Should I even attempt it now??

I *squander* untold effort making an arrangement of my thoughts that may have no value whatever. MS 118 94v c: 15.9.1937

Page 33

People have sometimes said to me†d they cannot make any judgement about this or that because they have never learnt philosophy. This is irritating nonsense,†e it is†f being assumed that philosophy is some sort of science. And people speak of it as they might speak of medicine.--What one can say, however, is that people who have never carried out an investigation of a philosophical sort, like most mathematicians for instance, are not equipped with the right optical instruments for that sort of investigation or scrutiny. Almost,†g as someone who is not used to searching in the forest for berries†h will not find any because his eye has not been sharpened for such things & he does not know where you have to be particularly on the lookout for them. Similarly someone unpractised in philosophy passes by all the spots where difficulties lie hidden under the grass, while someone with practice pauses & senses that there is a difficulty here, even though†i he does not yet

see it.--And no wonder, if one knows how long even the practised investigator, who realizes there is a difficulty, has to search in order to find it.

If something is well hidden it is hard to find.

MS 118 113r: 24.9.1937

Religious similes can be said to move on the edge of the abyss. B<unyan>'s allegory for instance. For what if we simply add: "and all these traps, swamps, wrong turnings, were planted by the Lord of the Road, the monsters, thieves, robbers were created by him?"

Without doubt, that is not the sense of the simile! but this sequel is too obvious! For many & for me it robs the simile of its power.

But more especially if this is--as it were--suppressed. It would be different if it were said openly at every turn: 'I am using this as a simile, but look: it doesn't fit here'. Then you wouldn't feel you were being cheated, that someone were trying to convince you by trickery. You can say to someone for instance: "Thank God for the good you receive but don't complain about the evil,†a as you would of course do if a human being were to do you good and evil by turns." Rules of life are dressed up in pictures. And these pictures can only serve to *describe* what we are supposed to do, but not to *justify* it. Because to be a justification they would have to hold good in other respects too. I can say: "Thank these bees for their honey as though they†i were good people who have prepared it for you"; that is *intelligible* & describes how I wish you to behave. But not: <">. Thank them, for look how good they are!"--since the next moment they may sting you.

Religion says: *Do this!--Think like that!* but it cannot justify this and it only need try to do so to become repugnant; since for every reason it gives, there is a cogent counter-reason.

It is more convincing to say: "Think like this!--however strange it may seem.--" Or: "Won't you do this?--repugnant as it is.--"

Election by grace: It is only permissible to write like this out of the most frightful suffering--& then it means something quite different. But for this reason it is not permissible for anyone to cite it as truth, unless he himself says it in torment.--It simply isn't a theory.--Or as one might also say: if this is truth, it is not the truth it appears at first glance to express. It's less

a theory than a sigh, or a cry. MS 118 117v: 24.9.1937

In the course of our conversations Russell would often exclaim: "Logic's hell!"--And this *fully* expresses what we†a experienced while†b thinking about the problems of logic; namely their immense difficulty. Their hardness--their hard & *slippery* texture.

The primary ground of this experience, I think, was this fact: that each new†c phenomenon of language that we might retrospectively think of†d could show our earlier explanation to be unworkable.†e†f But that is the difficulty Socrates gets caught up in when he tries to give the definition of a concept. Again and again an application of the word emerges that seems not to be compatible with the concept to which other applications have led us. We say: but that *isn't* how it is!--it *is* like that though!--& all we can do is keep repeating these antitheses. MS 119 59:

1.10.1937

The spring that flows quietly & clearly†g in the Gospels seems to foam in Paul's Epistles. Or that is how it seems to *me*. Perhaps it is just my own impurity that reads muddiness into it; for why shouldn't this impurity be able to pollute what is clear? But for *me* it's as though I saw human passion, something like pride or anger, which does not square with the humility of the *Gospels*. It is as though he really is insisting here on his own person, & *doing so moreover as a religious act*, something which is foreign to the Gospel. I want to ask--& may this be no blasphemy--: "What would Christ perhaps have said to Paul?"

But a fair rejoinder to that would be: What business is that of yours? Look after making *yourself* more decent! In your present state, you are quite incapable of understanding what may be the truth here.

In the Gospels--as it seems to me--everything is *less pretentious*, humbler, simpler. There you find huts;--with Paul a church. There all human beings are equal & God himself is a human being; with Paul there is already something like a hierarchy; honours, and official positions.--That is, as it were, what my NOSE tells me. MS 119 71:

4.10.1937

Page Break 36

Let us be human.--

Page 36

I just took some apples out of a paper bag where they had been lying for a long time; I had to cut off & throw away half of many of them. Afterwards as I was copying out a sentence of mine the second half of which was bad, I at once saw it as a half-rotten apple. And that's how it always is with me. Everything that comes my way becomes for me †a picture of what I am thinking about. (Is there something feminine about this outlook?) MS 119 83: 7.10.1937

Page 36

Doing this work I am †b in the same state as that of many people when they struggle in vain †c to recall a name; we say in such a case: "think of something else, then it will come to you"--& similarly I had constantly to think of something else †i so that what I had long been *searching* for could occur †d to me. MS 119 108: 14.10.1937

Page 36

The origin & the primitive form of the language game is a reaction; only from this can the more complicated forms grow.

Language--I want to say--is a refinement, 'in the beginning was the deed' †ii. MS 119 146: 21.10.1937

Page 36

Kierkegaard writes: If Christianity were so easy and cosy, why would God have moved Heaven & Earth in his Scripture, threatened *eternal* punishments-- --Question: But why is this Scripture so unclear then? If we want to warn someone of a terrible danger, do we do it by giving him a riddle to solve, whose solution is perhaps the warning?--But who is to say that the Scripture really is unclear: isn't it possible that it was essential in this case to tell a riddle? That a more direct warning, on the other hand, would necessarily have had the *wrong* effect? God has *four* people recount the life of the incarnate God, each one differently, & contradicting each other--but can't we say: It is important that this narrative should not have more than quite middling historical plausibility, *just so* that this †21 should not be taken as the essential, decisive thing. So that the *letter* should not be believed more strongly than is proper & the *spirit* should receive its due. I.e.: What you are supposed to see cannot be communicated even by the

Page Break 37

best, most accurate, historian; *therefore* a mediocre account suffices, is even to be preferred. For that too can tell you what you are supposed to be told. (Roughly in the way a mediocre stage set can be better than a sophisticated one, painted trees better than real ones,--which distract attention from what matters.)

The Spirit puts what is essential, essential for your life, into these words. The point is precisely that you are SUPPOSED to see clearly only what even *this* representation clearly shows. (I am not sure how far all this is exactly in the spirit of Kierkegaard.) MS 119 151: 22.10.1937

Page 37

In religion it must be the case that corresponding to every level of devoutness there is a form of expression that has no sense at a lower level. For those still at the lower level this doctrine, which means something at the higher level, is null & void; it *can* only be understood *wrongly*, & so these words are *not* valid for such a person.

Paul's doctrine of election by grace for instance is at my level irreligiousness, ugly non-sense. So it is not meant for me since I can only apply wrongly the picture offered me. If it is a holy & good picture, then it is so for a quite different level, where it must be applied in life quite differently than I could apply it. MS 120 8: 20.11.1937

Page 37

Christianity is not based on a historical truth, but presents us with a (historical) narrative & says: now believe! But not believe this report with the belief that †22 is appropriate to a historical report,--but rather: believe, through thick & thin & you can do this only as the outcome of a life. *Here you have a message!--don't treat it as you would another historical message!* Make a *quite different* place for it in your life.--There is no *paradox* about that!

Page 37

If I realized how mean & petty I am, I should become more modest.

Nobody can say with truth of himself that he is filth. For if I do say it, though it can be true in a sense, still I cannot myself be penetrated by this truth: otherwise I should have to go mad, or change myself.

Had coffee with A.R. †23; it was not as it used to be, but it was not *bad* either.

Queer as it sounds: the historical accounts of the Gospels might, in the historical sense, be demonstrably false, & yet belief would lose nothing through this: but *not* because it has to do with 'universal truths of reason'!

rather, because historical proof (the historical proof-game) is irrelevant to belief. This message (the Gospels) is seized on by a human being believably (i.e. lovingly): *That* is the certainty of this "taking-for-true", nothing *else*.

The believer's relation to these messages is *neither* a relation to historical truth (probability) *nor yet* that to a doctrine consisting of 'truths of reason'. There is such a thing.--(We have quite different attitudes even to different species of what we call fiction!) MS 120 83 c: 8-9.12.1937*

You cannot write more truly about yourself than you *are*. That is the difference between writing about yourself and writing about external things. You write about yourself from your own height. Here you don't stand on stilts or on a ladder but on your bare feet. MS 120 103 c: 12.12.1937

A great blessing for me to be able to work *today*. But I so easily forget all my blessings!

I am reading: "& no man can say that Jesus is the Lord, but by the Holy Ghost."†i And it is true: I cannot call him *Lord*; because that says absolutely nothing to me. I could call him "the paragon", "God" even or rather: I can understand it when he is so called; but I cannot utter the word "Lord" meaningfully. *Because I do not believe* that he will come to judge me; because *that* says nothing to me. And it could only say something to me if I were to live *quite* differently.

What inclines even me to believe in Christ's resurrection? I play as it were with the thought.--If he did not rise from the dead, then he decomposed in the grave like every human being. *He is dead & decomposed*. In that case he is a teacher, like any other & can no longer *help*; & we are once more orphaned & alone. And have to make do with wisdom & speculation. It is as though we are in a hell, where we can only†a dream & are shut out from heaven, roofed in as it were. But if I am to be REALLY redeemed,--I need *certainty*--not wisdom, dreams, speculation--and this *certainty* is faith. And faith is faith in what my *heart*, my *soul*, needs, not my speculative intellect. For my soul, with its passions, as it were with its flesh & blood, must be redeemed, not my abstract mind. Perhaps one may

say: Only *love* can believe the Resurrection. Or: it is *love* that believes the Resurrection. One might say: redeeming love believes even in the Resurrection; holds fast even to the Resurrection. What fights doubt is *as it were redemption*. Holding fast to *it* must be holding fast to this belief. So this means: first be redeemed & hold on tightly to your redemption (keep hold of your redemption)--then you will see that what you are holding on to is this belief. So this can only come about if you no longer support yourself on this†a earth but suspend yourself from heaven. Then *everything* is different and it is 'no wonder' if you can then do what now you cannot do. (It is true that someone who is suspended looks like someone who is standing but the interplay of forces within him is nevertheless a quite different one & hence he is able to do quite different things than can one who stands.) MS 120 108 c: 12.12.1937*

Freud's idea: in madness the lock is not destroyed, only altered; the old key can no longer open it, but a differently configured key could do so. MS 120 113: 2.1.1938

A Bruckner symphony can be said to have *two* beginnings: the beginning of the first idea & the beginning of the second idea. These two ideas stand to each other not as blood relations, but†b as man & wife.

Bruckner's Ninth is a sort of *protest* against Beethoven's, & because of this†c becomes bearable, which as a sort of imitation it would not be. It stands to Beethoven's Ninth very much as Lenau's Faust to Goethe's, which means as the Catholic to the Enlightenment Faust. etc. etc. MS 120 142: 19.2.1938

Nothing is so difficult as not deceiving yourself. MS 120 283: 7.4.1938

Longfellow:

In the elder days of art,
Builders wrought with greatest care
Each minute & unseen part,
For the gods are†i everywhere.
(This might serve as my motto.)

MS 120 289: 20.4.1938

Page Break 40

Phenomena akin to language in music or architecture. Significant irregularity--in Gothic e.g. (I have in mind too the towers of St. Basil's Cathedral.) Bach's music is more like language than Mozart's & Haydn's. The double bass recitative in the 4th movement of Beethoven's 9th Symphony. (Compare too Schopenhauer's remark about *universal* music composed to a *particular* text.) †24 MS 121 26v: 25.5.1938

Page 40

In philosophy the winner of the race is the one who can run most slowly. Or: the one who gets to the winning post last. †a †b MS 121 35v: 11.6.1938

Page 40

Being psychoanalyzed is in a way like eating from the tree of knowledge. †c The knowledge we acquire sets us (new) ethical problems; but contributes nothing to their solution. MS 122 129: 30.12.1939

Page 40

What is lacking in Mendelssohn's music? A 'courageous' melody? MS 162a 18: 1939-1940

Page 40

The Old Testament seen as the body without its head; the New T.: the head; the Epistles of the Apostles: the crown on the head.

If I think of the Jewish Bible, the Old Testament on its own, I should like to say: the head is (still) missing from this body The solution to these problems is missing The fulfilment of these hopes is missing. But I do not necessarily think of a head as having a *crown*. MS 162b 16v: 1939-1940

Page 40

Envy is something superficial--i.e.: the typical colour of envy does not go down deep--farther down passion has a different colouring. (*That* does not, of course, make envy any less real.) MS 162 21v: 1939-1940

Page 40

The measure of genius is character,--even if character on its own does *not* amount to genius
Genius is not 'talent *and* character', but character manifesting itself in the form of a special talent. Where one man will show courage by jumping into the water, another will show courage by writing a symphony. (This is a weak example.) MS 162b 22r c: 1939-1940

Page Break 41

There is no more light in a genius than in any other honest human being--but the genius concentrates this light into a burning point by means of a particular kind of lens.

Page 41

Why is the soul moved by idle thoughts,--since they are after all idle? Well, it is moved by them.
(How can the wind move a tree, since it is after all just wind †a ? Well, it *does* move it; & don't forget it.) MS 162b 24r: 1939-1940

Page 41

One *cannot* speak the truth;--if one has not yet conquered oneself. One *cannot* speak it--but not, because one is still not clever enough.

Page 41

The truth can be spoken only by someone who is already *at home* in it; not by someone who still lives in untruthfulness, & does no more than reach out towards it from within untruthfulness. MS 162b 37r c: 1939-1940

Page 41

Resting on your laurels is as dangerous as resting when hiking through snow. You doze off & die in your sleep. MS 162b 42v c: 1939-1940

Page 41

The monstrous vanity of wishes is revealed for instance in †b my wish to fill a nice notebook with writing as soon as possible. I get *nothing* from this; it's not that I wish it because, say, it will be evidence of my productivity; it is simply a *longing* to rid myself of something familiar as soon as I can; although of course, as soon as I am rid of it, I must start a fresh one & the whole business will have to be repeated. MS 162b 53r: 1939-1940

Page 41

One could call Schopenhauer a quite *crude* mind. I.e., †c He does have refinement, but at a certain level this suddenly comes to an end & he is as crude as the crudest. Where real depth starts, his finishes.

Page 41

One might say of Schopenhauer: he never takes stock of himself.

Page Break 42

I sit astride life like a bad rider on his mount. I owe it solely to the horse's good nature that I am not thrown off right now. MS 162b 55v: 1939-1940

Page 42

'The impression (made by this melody) is completely indescribable.'- That means: a description is no use (for my purpose); you have to hear the melody.

If art serves 'to arouse feelings', is, perhaps, perceiving it with the senses included amongst these feelings? MS 162b 59r: 1939-1940*

Page 42

My originality (if that is the right word) is, I believe, an originality that belongs to the soil, not the seed. (Perhaps I have no seed of my own.) Sow a seed in my soil, & it will grow differently than it would in any other soil. Freud's originality too was like this, I think. I have always believed--without knowing why--that the original seed of psychoanalysis was due to Breuer, not Freud. Of course Breuer's seed-grain can only have been quite tiny. (*Courage* is always original.)

Page 42

People nowadays think, scientists are there to instruct them, poets, musicians etc. to entertain them. *That the latter have something to teach them*; that never occurs to them.

Page 42

Piano playing, a dance of human fingers. MS 162b 59v: 1939-1940

Page 42

Shakespeare, one might say, displays the dance of human passions. For this reason he has to be objective, otherwise he would not so much display the dance of human passions--as perhaps talk about it. But he shows us them in a dance, not naturalistically. (I got this idea from Paul Engelmann.) MS 162b 61r: 1939-1940

Page 42

The comparisons of the N.T.†i leave room for as much depth of interpretation†a as you like. They are bottomless.†b

Page Break 43

They have less style than the first speech of a child. Even a work of supreme art has something that can be called 'style', yes even something that can be called 'fashion'. MS 162b 63r: 1939-1940

Page 43

Within all great art there is a WILD animal: tamed.

Not, e.g., in Mendelssohn. All great art has primitive human drives as its ground bass. They are not the *melody* (as they are, perhaps, in Wagner), but they are what gives the melody *depth†a & power*.

In *this* sense one may call Mendelssohn a 'reproductive' artist.--

In the same sense: my house for Gretl†25 is the product of a decidedly sensitive ear, *good* manners, the expression of great *understanding* (for a culture, etc.). But *primordial* life, *wild* life striving to erupt into the open--is lacking. And so you might say,†b *health* is lacking (Kierkegaard). (Hothouse plant.) MS 122 175 c: 10.1.1940

Page 43

A teacher who can show good, or indeed†c astounding results while he is teaching, is still not on that account a good teacher, for it may be that, while his pupils are under his immediate influence, he raises them to a level which is not natural to them, without developing their own capacities for work at this level, so that they immediately decline again once the teacher leaves the schoolroom. Perhaps this holds for me; I have thought about this. (When Mahler was himself conducting, his private performances†26 were excellent; the orchestra seemed to collapse at once if†d he was not conducting it himself.) MS 122 190 c: 13.1.1940

Page 43

'The aim of music: to communicate feelings.'

Connected with this: We may rightly say "he has†e now the same face as before"--although measurement gave different results in the two cases.

How are the words "the same facial expression" used?--How do we know that someone is using these words correctly? But how do I know that I am using them correctly? MS 122 235: 1.2.1940

Page 43

Not funk but funk conquered is what is worthy of admiration & makes life

Page Break 44

worth having been lived. Courage, not cleverness; not even inspiration, is the grain of mustard that grows up to be a great tree. To the extent there is courage, there is connection with life & death. (I was thinking of Labor's & Mendelssohn's organ music.) But it is not by recognizing the want of courage in someone else, that you acquire courage yourself. MS 117 151 c: 4.2.1940

Page 44
One might say: "Genius is *courage in one's talent*". MS 117 152 c: 4.2.1940

Page 44
Try to be loved & not-admired.†27 MS 117 153 c: 4.2.1940

Page 44
Sometimes you have to take an expression out of the language,†a to send it for cleaning,--& then you can put it back into circulation. MS 117 156: 5.2.1940

Page 44
How hard it is for me to see what is *right in front of my eyes*! MS 117 160 c: 10.2.1940

Page 44
You can't be reluctant to give up your lie & still tell the truth. MS 117 168 c: 17.2.1940

Page 44
Writing the right style means, setting the carriage precisely†b on the rails. MS 117 225: 2.3.1940

Page 44
If this stone won't budge at present, if it is wedged in, first move other stones around it.--

Page 44
We are only going to set you straight on the track, if your carriage stands on the rails crookedly; driving†c is something we shall leave you to do by yourself.†d MS 117 237: 6.3.1940

Page 44
Scraping away mortar is much easier than moving a stone. Well, you have to do the one, before you can do the other. MS 117 253: 11.3.1940

Page Break 45

What is insidious about the causal approach is that it leads one to say: "Of course,†a that's how it has to†b happen". Whereas one ought to say: It may have happened *like that*, & in many other ways.†c

Page 45
If we use the ethnological approach does that mean we are saying philosophy is ethnology? No it only means we are taking up our position far outside, in order to see the things *more objectively*. MS 162b 67r: 2.7.1940

Page 45
One of my most important methods is to imagine a historical development of our ideas different from what has†d actually occurred. If we do that the problem shows us a quite new side. MS 162b 68v: 14.8.1940

Page 45
What I am resisting is the concept of an ideal exactness thought as it were to be given us a priori. At different times our ideals of exactness are different; & none of them is preeminent. MS 162b 69v: 19.8.1940

Page 45
It is often only very slightly more disagreeable to tell the truth than a lie; only about as much as is drinking bitter rather than sweet coffee; & yet even then I have a strong inclination to tell the lie. MS 162b 70r: 21.8.1940

Page 45
(My style is like bad musical composition.)

Page 45
Don't apologize for anything, don't obscure anything, look & tell how it really is--but you must see something that sheds a new light on the facts. MS 123 112: 1.6.1941

Page 45
Our greatest stupidities may be very wise. MS 124 3 c: 6.6.1941

Page 45
It is incredible how helpful a new drawer can be, suitably placed in our filing cabinet. MS 124 25: 11.6.1941

Page 45
You must say something new & yet nothing but what is old. (N.)

Page Break 46

You must indeed say only what is old--but *all the same* something new!

Page 46

Different 'interpretations' must correspond to different applications.

Page 46

The poet too must always be asking himself: 'is what I am writing really true then?' which does not necessarily mean: 'is this how it happens in reality?'

Page 46

(...)

Page 46

It's true you must assemble old material. But for a *building*.--(W.)†28 MS 124 28: 11.6.1941

Page 46

As we get old the problems slip through our fingers again, as in our youth. It is not just that we cannot crack them open,†a we can't even keep hold of them. MS 124 31: 12.6.1941

Page 46

What a curious attitude scientists have--: "We still don't know that;†b but it is knowable & it is only a question of time till we know it"! As if that went without saying.-- MS 124 49: 16.6.1941

Page 46

I could imagine someone thinking the names "Fortnum" & "Mason"†29 fitted together. MS 124 56: 18.6.1941

Page 46

Don't demand too much, & don't be afraid that your just demand will melt into nothing. MS 124 82: 27.6.1941

Page 46

People who are constantly asking 'why' are like tourists, who stand in front of a building, reading Baedeker, & through reading about the history of the building's construction etc etc are prevented from *seeing* it. MS 124 93: 3.7.1941

Page 46

Counterpoint might represent an extraordinarily difficult problem for a composer; the problem namely: given *my* propensities what should be *my* relation towards counterpoint. He may have found a conventional relation

Page Break 47

to it yet feel perhaps that it is not *his*. That it is not clear what the importance of counterpoint to him *ought* to be.

(I was thinking of Schubert in this connection; of his still wanting to take lessons in counterpoint at the end of his life. I think his aim may have been not simply learning more counterpoint, but rather determining where he stood in relation to it.) MS 163 25r: 4.7.1941

Page 47

Wagner's motifs might be called musical prose sentences. And just as there is such a thing as "rhyming prose", so too these motifs can certainly be put together into melodic form, but without their constituting *one* melody.

Page 47

Wagnerian drama too is not drama, but a stringing together of situations as if on a thread, which for its part is only cleverly spun but not, like the motifs & situations, inspired. MS 163 34r: 7.7.1941

Page 47

Don't let yourself be guided by the example of others, but by nature! MS 163 39r c: 8.7.1941

Page 47

The language used by philosophers is already deformed, as though by shoes that are too tight. MS 163 47v: 11.7.1941

Page 47

The characters in a drama arouse our sympathy, they are like people we know, often like people we love or hate: The characters in the second part of Faust don't arouse our sympathy at all! We don't feel as though we knew them. They file past us like thoughts not like human beings. MS 163 64v c: 6.9.1941

Page 47

The mathematician (Pascal) who admires the beauty of a theorem in number theory†a; it is as though he were admiring some natural beauty. It's wonderful, he says, what splendid properties numbers have. It's as though he were admiring the conformity to laws of a crystal†b.

Page 47

One might say: what splendid laws the Creator has built into numbers!

Page Break 48

Page 48

You can't *construct* clouds. And that is why the future you dream of never comes true.

Page 48

Before there was an aeroplane people dreamed about aeroplanes & what a world with them would look like. But, as the reality was nothing like this dream, so we have no reason to believe that reality will develop in the way we dream. For our dreams are full of tinsel, like paper hats & costumes. MS 125 2v: 4.1.1942 or later

Page 48

The popular scientific writings of our scientists are not the expression of hard work but of resting on their laurels. †a †b †30

Page 48

If you already *have* someone's love, no sacrifice is too high a price to pay for it but any sacrifice is too great †c to *buy* it. MS 125 21r: 1942

Page 48

Virtually as there is such a thing as a *deep* & a shallow sleep, there are thoughts which occur deep within one & thoughts which romp about on the surface. MS 125 42r: 1942

Page 48

You cannot draw the seed up out of the earth. You can only give it warmth †d, moisture & light & then it must grow. (You mustn't even *touch* †e it except with care.) MS 125 44r: 1942

Page 48

What is pretty cannot be beautiful.----- MS 125 58r: 1942

Page 48

Someone is *imprisoned* in a room if the door is unlocked, opens inwards; but it doesn't occur to him to *pull*, rather than push against it.

Page 48

Put someone in the wrong atmosphere & nothing will function as it should. He will seem unhealthy in every part. Bring him back into his right element, & everything will blossom and look healthy. But if he is not in his

Page Break 49

right element, what then? Well he just has to make the best of looking like a cripple.

Page 49

If white turns to black some say: "Essentially it is still the same". And others, if the colour becomes †a one degree darker, say "It has changed *completely*." MS 125 58v: 18.5.1942

Page 49

Architecture is a *gesture*. Not every purposive movement of the human body is a gesture. Just as little as every functional building is architecture. MS 126 15r: 28.10.1942

Page 49

At present we are combatting a trend. But this trend will die out, superseded by others. And then people will no longer understand our arguments against it; will not see why all that needed saying. MS 126 64r: 15.12.1942

Page 49

Looking for the fallacy in a fishy argument & hunt-the-thimble. MS 126 65v: 17.12.1942

Page 49

Suppose that 2000 years ago someone had invented the *shape*

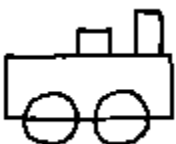

& said that one day it would be the shape of an instrument of locomotion.

Or perhaps: that someone had constructed the complete *mechanism* of the steam engine without having the least †b idea how it could be used as a motor. †c MS 127 14r: 20.1.1943

Page 49

What you are taking for a gift is a problem you have to solve.

Page 49

Genius is what makes us forget the master's talent.

Page 49

Genius is what makes us forget talent. †d

Where genius wears thin skill may show through.†e (Overture to the Mastersingers.

Genius is what makes us unable to see the master's talent.

Only where genius wears thin can you see the talent.

MS 127 35v: 4.4.1943

Why shouldn't I apply words in opposition to their original usage? Doesn't e.g. Freud†a do that when he calls even an anxiety dream a wish-fulfilment dream? Where is the difference? In the scientific approach the new use is justified through a *theory*. And if this theory is false then the new extended use has to be given up too. But in philosophy the extended use is not supported by true or false opinions about natural processes. No fact†b justifies it (&)†c non can overturn it.

We say:†d "You understand this expression, don't you? Well, the way you always understand it†e is the way I too am using it."†f [Not: "... in *that* meaning..."]

As though meaning were a halo which the word carries over†g†h into every sort of application MS 127 36v: 27.2.1944

Thoughts at peace. That is the goal someone who philosophizes longs for. MS 127 41v: 4.3.1944

The philosopher is someone who has to cure many diseases of the understanding in himself, before he can arrive at the notions of common sense. MS 127 76r: 1944

If in life we are surrounded by death, so too in the health of our understanding by madness.†i†j31 MS 127 77v: 1944

Wanting to think is one thing, having a talent for thinking another.

MS 127 78v: 1944

If there is anything in the Freudian theory of dream interpretation; then it shows how *complicated* is the way the human mind makes†a pictures of the facts.

So complicated, so irregular is the mode of representation that it can *barely* be called representation any more. MS 127 84r: 1944

It will be hard to follow my portrayal: for it says something new, but still has eggshells of the old material sticking to it. MS 129 181: 1944 or later

Is it some frustrated longing that makes someone mad? (I was thinking of Schumann, but of myself too.) MS 165 200 c: ca. 1941-1944

The revolutionary will be the one who can revolutionize himself.

MS 165 204: ca. 1944

People are religious to the extent that they believe themselves to be not so much *imperfect* as *sick*.

Anyone who is half-way decent will think himself utterly imperfect, but the religious person thinks himself *wretched*

What's ragged should be left ragged.

A miracle is, as it were, a *gesture* which God makes. As a man sits quietly & then makes an impressive gesture, God lets the world run on smoothly & then accompanies the words of a Saint by a symbolic occurrence, a gesture of nature. It would be an instance if, when a saint has spoken, the trees around him bowed, as if in reverence.--Now, do I believe that this happens? I don't.

The only way for me to believe in a miracle in this sense would be to be *impressed* by an occurrence in this particular way. So that I should say e.g.: "It was *impossible* to see these trees & not to feel that they were responding to the words." Just as I might say "It is impossible to see the face of this dog & not to see that he is alert & full of attention to what his master is

Page Break 52

doing <">. And I can imagine that the mere report of the *words* & life of a saint can make someone believe the reports that the trees bowed. But I am not so impressed.

Page 52

When I came home I expected a surprise & there was no surprise for me, so, of course, I was surprised. MS 128 46: ca. 1944

Page 52

Go on, believe! It does no harm.

Page 52

'Believing' means, submitting to an authority. Having once submitted to it, you cannot then, without rebelling against it, first call it in question & then once again find it convincing.

Page 52

A cry of distress cannot be greater than that of *one* human being.

Page 52

Or again *no* distress can be greater than what a single person can suffer.

Hence one human being can be in infinite distress & so need infinite help.

The Christian religion is only for the one who needs infinite help, that is only for the one who suffers infinite distress.

Page 52

The whole Earth cannot be in greater distress than *one* soul.

Page 52

Christian faith--so I believe--is refuge in this *ultimate* distress.

Someone to whom it is given in such distress to open his heart instead of contracting it, absorbs the remedy into his heart.

Someone who in this way opens his heart to God in remorseful confession opens it for others too. He thereby loses his dignity as someone special†a & so becomes like a child. That means without office, dignity & aloofness from others. You can open yourself to others only out of a particular kind of love. Which acknowledges as it were that we are all wicked children.

Page 52

It might also be said: hate between human beings comes from our cutting ourselves off from each other. Because we don't want anyone else to see inside us, since it's not a pretty sight in there.

Page Break 53

Page 53

Of course you must continue to feel ashamed of what's within you, but not ashamed of yourself before your fellow human beings.

Page 53

There is no greater distress to be felt than that of One human being. For if someone feels himself lost, that is the ultimate distress. MS 128 49: ca. 1944

Page 53

Words are deeds. †32 MS 179 20: ca. 1945

Page 53

Only someone very unhappy has the right to pity someone else. MS 179 26: ca. 1945

Page 53

It isn't reasonable to be furious even at Hitler; let alone at God. MS 179 27: ca. 1945

Page 53

When people have died we see their life in a conciliatory light. His life looks well-rounded through a haze. For *him* it was not well-rounded however, but jagged & incomplete. For him there was no conciliation; his life is naked & wretched. MS 180a 30: ca. 1945

Page 53

It is as though I had lost my way & asked someone the way home. He says he will show me and walks with me along a nice smooth path. This suddenly comes to an end. And now my friend says: "All you have to do now is to find the rest of the way home from here."†33

MS 180a 67: ca. 1945

Page 53

The less somebody knows & understands himself the less great he is, however great may be his talent. For this reason our scientists are not great. For this reason Freud, Spengler, Kraus, Einstein are not great. MS 130 239: 1.8.1946*

Page 53

Schubert is irreligious & melancholy.

MS 130 283: 5.8.1946

Page 53

Are *all* people great human beings? No.--Well then, what hope can you have of being a great human being! Why should something be given you that is not given your fellows? To what purpose?!--If it isn't your *wish* to be rich that makes you think you are rich, then it must be some observation some experience that shows you it! And what experience do you have (except that of vanity)? Simply that you have a *talent*. And my conceit of

Page Break 54

being an extraordinary human being is of course *much* older than my experience, of my particular talent. MS 130 291 c: 9.8.1946

Page 54

Schubert's melodies can be said to be full of *climaxes*, & this cannot be said of Mozart's; Schubert is baroque. You can point to particular places in a Schubert melody & say: look, that is the point of this melody, this is where the idea comes to a head.

Page 54

The melodies of different composers can be approached by applying the principle: every species of tree is a 'tree' in a different sense of the word. I.e. Don't let yourself be misled by our saying they are all melodies. They are steps along a path that leads from something you would not call a melody to something else that you again would not call one. If you simply look at the sequences of notes & the changes of key all these structures no doubt appear on the same level. But if you look at the field of force in which they stand (and hence at their significance), you will be inclined to say: Here melody is something quite different than there (here it has a different origin, plays a different role, inter alia.

MS 131 2: 10.8.1946

Page 54

The idea working its way towards the light.

MS 131 19: 11.8.1946

Page 54

The remark by Jucundus in "The Lost Laugh"†34, that his religion consisted in: his knowing, if things are going well for him now,†a that his fate could take a turn for the worse--this actually is an expression of the same religion as the saying "The Lord hath given, the Lord hath taken away".

MS 131 27: 12.8.1946

Page 54

It is hard to understand yourself properly since something that you *might* be doing out of generosity & goodness is the same as you may be doing out of cowardice or indifference. To be sure, one may act in such & such a way from true love, but also from deceitfulness & from a cold heart too. Similarly not all moderation is goodness. And only if I could be submerged in religion might these doubts be silenced. For only religion could destroy vanity & penetrate every nook & cranny.

MS 131 38: 14.8.1946

Page 54

What I want to say then is: Someone who--e.g.--cannot EXPERIENCE

Page Break 55

the word "pas" in "je ne sais pas" as "step", cannot be taught an expression of voice†a by being told "speak it with this meaning".

If you are reading aloud and want to read *well*, you accompany the words with more vivid images. At least it is *often* like that. Sometimes though ["To Corinth from Athens..."]†35 it is the punctuation, i.e., the precise intonation & the length of the pauses that is all that matters to us.

MS 131 43: 14.8.1946*

Page 55

It is remarkable how hard we find it to believe something the truth of which we do not see for ourselves. If e.g. I hear expressions of admiration for Shakespeare made by the distinguished men of several centuries, I can never rid myself of a suspicion that praising him has been a matter of convention, even though I have to tell myself that this is not the case. I need the authority of a *Milton* to be really convinced. In his case I take it for granted that he was

incorruptible.--But of course I don't mean to deny by this that an enormous amount of praise has been & still is lavished on Shakespeare without understanding & for specious reasons by a thousand professors of literature. MS 131 46: 15.8.1946

Page 55

Grasping the difficulty *in its depth* is what is hard.

For if you interpret it in a shallow way the difficulty just remains. It has to be pulled out by the root; & that means, you have to start thinking about these things in a new way. The change is as decisive e.g. as that from the alchemical to the chemical way of thinking.--The new way of thinking is what is so hard to establish.

Page 55

Once it†b is established the old problems disappear; indeed it becomes hard to recapture them. For they are embedded in the way we express ourselves; & if we clothe ourselves in a new form of expression, the old problems are discarded along with the old garment.†c MS 131 48: 15.8.1946

Page 55

The hysterical fear of the atom bomb the public now has, or at least expresses, is almost a sign that here for once a really salutary discovery has been made. At least the fear gives the impression of being fear in the face of a really effective bitter medicine. I cannot rid myself of the thought: if there

Page Break 56

were not something good here, the *philistines* would not be making an outcry. But perhaps this too is a childish idea. For all I can mean really is that the bomb creates the prospect of the end, the destruction of a ghastly evil, of disgusting soapy water science and certainly that is not an unpleasant thought; but who is to say what would come *after* such a destruction? The people now making speeches against the production of the bomb are undoubtedly the *dregs* of the intelligentsia, but even that does not prove beyond question that what they abominate is to be welcomed. MS 131 66c: 19.8.1946

Page 56

In former times people entered monasteries. Were they perhaps simple-minded, or obtuse people?--Well, if people like that took such measures so as to be able to go on living, the problem cannot be an easy one! MS 131 79 c: 20.8.1946

Page 56

The human being is the best picture of the human soul.†36 MS 131 80:20.8.1946

Page 56

Shakespeare's similes are, *in the ordinary sense*, bad. So if they are nevertheless good--& I don't know whether they are or not--they must be a law to themselves. Perhaps e.g. their ring makes them convincing & gives them truth. It might be the case that with S. the essential thing is his effortlessness, his arbitrariness, so that if you are to be able really to admire him, you just have to accept him as he is in the way you accept nature, a piece of scenery e.g.

If I am right about this, that would mean that the style of his whole work, I mean, of his complete works†a is in this case what is essential, & provides the justification.

Page 56

That I do *not* understand him could then be explained by the fact that I cannot read him *with ease*. Not, that is, as one views a splendid piece of scenery. MS 131 163:31.8.1946

Page 56

A man sees well enough what he has, but not what he is. What he is can be compared with his height above sea level, which you cannot for the most part judge straight off. And the greatness, or triviality, of a work depends on where its creator stands.

Page Break 57

Page 57

But you can equally say: someone who misjudges himself is never great: someone who throws dust in his own eyes. MS 131 176: 1.9.1946

Page 57

How small a thought it takes to fill a whole life!

Page 57

Just as someone may travel around the same little country throughout his whole life, & think there is nothing outside it!

You see everything in a queer perspective (or projection): the country that you ceaselessly keep covering, strikes you

as enormously big; the surrounding countries seem to you like narrow border regions.†a MS 131 180: 2.9.1946

Page 57

To go down into the depths you don't need to travel far; you can do it in your own backgarden.†b MS 131 182: 2.9.1946

Page 57

It is very *remarkable*, that we should be inclined to think of civilization--houses, streets, cars, etc--as separating man from his origin, from the lofty, eternal, etc. Our civilized environment, even its trees & plants, seems to us then cheap, wrapped†c in cellophane, & isolated from everything great & from God as it were. It is a remarkable picture that forces itself on us here. MS 131 186: 3.9.1946

Page 57

My 'achievement' is very much like a mathematician's,†d who invents a new calculus.†e MS 131 218: 8.9.1946

Page 57

If people did not sometimes commit stupidities, nothing intelligent at all would ever happen. MS 131 219: 8.9.1946

Page 57

The purely corporeal can be uncanny. Compare the way†f angels & devils are portrayed. A so-called "miracle" must be connected with this. It must be as it were a *sacred gesture*. MS 131 221: 8.9.1946

Page Break 58

The way you use the word "God" does not show *whom* you mean,†a but what you mean. MS 132 8: 11.9.1946

Page 58

In a bullfight the bull is the hero of a tragedy. First driven mad by suffering, he dies a slow & terrible death. MS 132 12: 12.9.1946

Page 58

A hero looks death in the face, real death, not just a picture of death. Behaving decently in a crisis does not mean being able to act the part of a hero well, as in the theatre, it means rather being able to look death *itself* in the eye. For an actor may play a multitude of roles, but in the end it is after all he himself, the human being, who has to die. MS 132 46 c: 22.9.1946

Page 58

What does it consist in: following a musical phrase with understanding? Observing a face with a feeling†b for its expression? Drinking in the expression on the face?

Page 58

Think of the demeanour of someone who draws the face with understanding for its expression. Think of the sketcher's face his movements;--what shows that every stroke he makes is†i dictated by the face, that nothing in his sketch is arbitrary, that he is a *delicate* instrument?

Is that really an *experience*? I mean: can we say that this expresses an experience?

Page 58

Once again: what does it consist in, following a musical phrase with understanding, or, playing it with understanding? Don't look inside yourself. Ask yourself rather, what makes you say that's what *someone else* is doing. And *what* prompts you to say *he* has a particular experience? Indeed, do we ever actually say that? Wouldn't I be more likely to say of someone else that he's having a whole host of experiences†ii?

I would perhaps say: "He is experiencing the theme intensely"; but ask yourself, what the expression of this†c is?†d†e

Page Break 59

Then again you might think intensive experiencing of the theme '*consists*' in the sensations of the movements etc. with which we accompany it. And that seems (again) like a soothing explanation. But have you any reason to think it true? I mean, e.g., a recollection of this experience? Is not this theory again merely a picture? No, this is not how things are: the theory is no more than an attempt to link up the expressive movements with an 'experience'.

Page 59

If you ask: how I experienced the theme, I shall perhaps say "As a question" or something of the sort, or I shall whistle it with expression etc. MS 132 51: 22.9.1946

Page 59

"He is experiencing the theme intensely. Something is happening in him when†a he hears it." Well, *what*?

Page 59

Does the theme point to nothing beyond itself? Oh yes! But that means:--The impression it makes on me is connected with things in its surroundings--e.g. with the existence of the German language & of its intonation, but that means with the whole field†i of our language games.†37

If I say e.g.: it's as if here a conclusion were being drawn, or, as if here something were being confirmed, or, as if *this* were a reply to what came earlier,--then the way I understand it clearly presupposes familiarity with conclusions, confirmations, replies, etc.

Page 59

A theme, no less than a face, wears an expression.

Page 59

"The repeat is *necessary*" In what respect is it necessary? Well, sing it, then you will see that it is only the repeat that gives it its tremendous power.--Don't we feel then as though a model for this theme must in this case exist in reality, & as though the theme only approached it, corresponded to it, once this part were repeated Or am I to utter the inanity: 'It just sounds more beautiful with the repeat'? (You see there by the way what an inane role the word "beautiful" plays in aesthetics) And yet there just *is* no paradigm there other than the theme. And yet again there *is* a paradigm other than the theme: namely the rhythm of our language, of our thinking & feeling. And furthermore the theme is a *new* part of our language, it becomes incorporated in it; we learn a new *gesture*.

Page Break 60

Page 60

The theme interacts with language.

Page 60

It is one thing to sow in thought, another to reap in thought.

Page 60

The last two bars of the "Death & the Maiden" theme, the ; you may think first that this figure is conventional, ordinary, until you understand its deeper expression. I.e. until you understand that here the ordinary is filled with significance. MS 132 59: 25.9.1946

Page 60

"Fare well!"

"A whole world of pain lies in these words" How can it live†a in them?--It is bound up with them. The words are like the acorn from which an *oak tree* can grow.

But where is the law laid down, according to which the tree grows out of the acorn? Well, the picture is incorporated into our thinking as a result of experience.†b MS 132 62: 25.9.1946*

Page 60

Esperanto. Our feeling of disgust, when we utter an *invented* word with invented derivative syllables. The word is cold, has no associations & yet plays at 'language'. A system of purely written signs would not disgust us like this. MS 132 69: 26.9.1946

Page 60

You could attach prices to ideas. Some cost a lot some little. [Broad's ideas all cost *very* little.] And how do you pay for ideas? I believe: with courage. MS 132 75: 28.9.1946*

Page 60

If life becomes hard to bear we think of improvements†c. But the most important & effective improvement,†d in our own attitude, hardly occurs to us, & we can decide on this only with the utmost difficulty.†e MS 132 136: 7.10.1946

Page 60

It's possible to write in a style that is unoriginal in form--like mine--but with well chosen words; or on the other hand in one that is original in *form*, *freshly* grown from within oneself. (And also of course in one which is botched together just anyhow out of old furnishings†f.) MS 32 145: 8.10.1946

Page Break 61

Amongst other things Christianity says, I believe, that sound doctrines are all useless. That you have to change your *life*. (Or the *direction* of your life.)

That all wisdom is cold; & that you can no more use it for setting your life to rights, than you can forge iron when it is *cold*.

For a sound doctrine need not *seize* you; you can follow it, like a doctor's prescription.--But here you have to

be seized & turned around by something.--(I.e. this is how I understand it.) Once turned round, you must *stay* turned round.

Wisdom is passionless. By contrast Kierkegaard calls faith a *passion*. MS 132 167: 11.10.1946

Page 61

Religion is as it were the calm sea bottom at its deepest, remaining calm, however high the waves rise on the surface.-- MS 132 190: 16.10.1946

Page 61

"I never before believed in God"--that I understand. But not: "I never before really believed in Him." MS 132 191: 18.10.1946

Page 61

I often fear madness. Have I any reason to assume that this fear does not spring from, so to speak, an optical illusion: of seeing something as an abyss that is close by, when it isn't? The only *experience* I know of that speaks for its not being an illusion, is the case of Lenau. For in his "Faust" there are thoughts of a kind I too am familiar with. Lenau puts them into Faust's mouth, but they are no doubt his own about himself. What is important is what Faust says about his *loneliness* or *isolation*.

Page 61

His talent too strikes me as similar to mine: A lot of froth--but a few *fine* thoughts. The stories in his Faust are all bad, but the observations often true & great. MS 132 197: 19.10.1946

Page 61

Lenau's Faust is remarkable in that here man has dealings only with the Devil. God does not stir himself. MS 132 202: 20.10.1946

Page 61

In my view Bacon was not a *precise thinker*. He had large, as it were broad, visions But someone who has nothing but these is bound to be generous with promises, inadequate in keeping them. You may *envision* a flying machine without being precise about its details. Outwardly you may†a imagine it as very similar to a proper aeroplane, & describe its functioning

Page Break 62

graphically. Nor is it obvious, that such an invention†a has to be worthless. Perhaps it spurs others to a different sort of work.--So while these others make preparations, a long time in advance as it were, for building an aeroplane that really flies, the former occupies himself with dreaming what this aeroplane has to look like & what it will be capable of. This so far says *nothing* about the value of these activities. The dreamer's *may* be worthless--& so may the others. MS 132 205: 22.10.1946

Page 62

Madness doesn't *have* to be regarded as an illness. Why not as a sudden--more or *less* sudden--change of character? Everybody is (or most are) mistrustful, & perhaps more so towards their relations, than towards others. Is there any reason for mistrust? Yes & no. Reasons can be given for it, but they are not compelling. Why shouldn't someone suddenly become *much* more mistrustful of people? Why not *much* more withdrawn? or devoid of love? Don't people get like this even in the ordinary course of events?--Where is the line to be drawn here between will & ability? Is it that I *will* not open my heart to anyone any longer, or that I *cannot*? If so much can lose its attraction, why not everything? If someone is wary even in ordinary life, why shouldn't he--& *perhaps* suddenly--become *much* more wary? And *much* more inaccessible. MS 133 2: 23.10.1946

Page 62

The lesson in a poem is *overstated*, if the intellectual points are nakedly exposed, not clothed by the heart. MS 133 6: 24.10.1946

Page 62

Oh a key can†38 lie for ever where the locksmith placed it, & never be used to open†b the lock for which the master forged it. MS 133 12: 24.10.1946

Page 62

"It is high time for us to compare this phenomenon†c with something *different*"--one may say.--I am thinking, e.g. of mental illnesses. MS 133 18: 29.10.1946

Page 62

Freud's fanciful pseudo-explanations (just because they are so brilliant) performed a disservice.

Page Break 63

Page 63

(Now every ass has them†a within reach for 'explaining' symptoms of illness with their help.) MS 133 21:
31.10.1946

Page 63

Irony in music. E.g. Wagner in the Mastersingers. Incomparably deeper in the first movement of the IXth in the fugato. Here is something, that corresponds to the expression of bitter irony in speech.

Page 63

I could equally well have said: the distorted in music. In the sense in which we speak of features distorted by grief. When Grillparzer says Mozart countenanced only the "beautiful" in music, that means, I think, that he did not countenance the distorted, frightful, that there is nothing in his music corresponding to *this*. I am not saying that is quite true; but assuming it to be so, it is a prejudice on Grillparzer's part, to think that by rights it ought not to be otherwise. The fact that music since Mozart (of course especially through Beethoven) has extended the range of its language is to be neither commended nor deplored, rather: *that's* how it is.†b Grillparzer's *attitude* involves a certain ingratitude. Did he want *another* Mozart? Could he imagine something†39 that such a being might compose? Would he have been able to imagine Mozart if he had not known him?
The concept of "the beautiful" has done a lot of mischief here too.

Page 63

Concepts *may* alleviate mischief or make it worse; foster it or check it. MS 133 30: 1.-2.11.1946

Page 63

The fundamental insecurity of life. Misery, everywhere you look.

The grinning faces of idiots may, it is true, make us think *they* do not really suffer; but they do, only not in the same place as the more intelligent. They do not have, as one might say, *headache*, but as much other wretchedness as anyone else. Not all wretchedness need after all evoke the *same* facial expression. A nobler person who suffers will look different from me.

MS 133 68 c: 12.11.1946*

Page 63

I cannot kneel to pray, because it's as though my knees were stiff. I am afraid of dissolution (of my own dissolution) should I become soft.

MS 133 82: 24.11.1946

Page Break 64

I am showing my pupils sections of an immense landscape, which they cannot possibly find their way around. MS 133 82: 24.11.1946

Page 64

The truly apocalyptic view of the world is that things do *not* repeat themselves. It is not e.g. absurd to believe that the scientific & technological age is the beginning of the end for humanity, that the idea of Great Progress is a bedazzlement, along with the idea that the truth will ultimately be known; that there is nothing good or desirable about scientific knowledge & that humanity, in seeking it, is falling into a trap. It is by no means clear that this is not how things are.

MS 133 90: 7.1.1947

Page 64

A man's dreams are virtually never realized.

MS 133 118: 19.1.1947

Page 64

Socrates, who always reduces the Sophist to silence--does he reduce him to silence *rightfully*?--It's true, the Sophist does not know what he thinks he knows; but that is no triumph for Socrates. It can neither be a case of "You see! You don't know it!"--nor, triumphantly, "So none of us knows anything!"

Because I don't want to think *just* to convict myself, or even someone else, of unclarity I am not trying to understand something,†a *simply* in order to see that I still do not understand it. MS 133 188: 27.2.1947*

Page 64

Wisdom is something cold, & to that extent foolish. (Faith, on the other hand, a passion.) We might also say: wisdom merely *conceals* life from you. (Wisdom is like cold, grey ash covering the glowing embers.) MS 134 9:
3.3.1947

Page 64

Don't *for heaven's sake*, be afraid of talking nonsense! Only don't fail to pay attention to your nonsense. MS 134 20:
5.3.1947

Page 64

The miracles of nature,

We might say: art *discloses* the miracles of nature to us. It is based on the *concept* of the miracles of nature. (The blossom, just opening out. What is *marvellous* about it?) We say: "Look, how it's opening out!"

It could only be by accident that someone's dreams about the future of

philosophy, art, science would come true. What he sees is a continuation of his own world in his dream, that is to say PERHAPS his wish (and perhaps not) but not reality.

It might still happen that a person's photograph, e.g., changed with time, almost as if he were aging on it. But its changes then take place according to their own laws & why should they lead in a parallel direction to the development of the real person?

The mathematician too can of course marvel at the miracles (the crystal) of nature; but can he do it, once a problem has arisen about *what* he sees?†a Is it really possible as long as the object he finds awe-inspiring or gazes at with awe is shrouded in a philosophical fog?

I could imagine someone admiring trees, & also the shadows, or reflections of trees, which he mistakes for trees. But if he should once tell himself that these†b are not after all trees & if it becomes a problem for him what they are, or what relation they have to trees, then his admiration will have suffered a rupture, that will now need healing. MS 134 27: 10.-15.3.1947*

Sometimes a sentence can be understood only if it is read at the *right tempo*. My sentences are all to be read *slowly*. MS 134 76: 28.3.1947

The 'necessity' with which the second idea succeeds the first. (Overture to Figaro.) Nothing could be more idiotic than to say it's '*pleasing*' to hear the second after the first!--But the paradigm according to which everything there is *right* is certainly obscure. 'It is the natural development.' You gesture with your hand, would like to say: "of course!"--You could too compare the transition to a transition (the entry of a new character) in a story, e.g., or a poem. *That* is how this piece fits into the world of our thoughts & feelings. MS 134 78: 30.3.1947

The folds of my heart all the time tend to stick together & to open it I should need to keep tearing them apart. MS 134 80 30.3.1947

A foolish & naïve American film can in all its foolishness & *by means of* it be instructive. A fatuous, non-naïve†c English film can teach nothing. I have

often drawn a lesson from a foolish American film. MS 134 89: 2.4.1947

Is what I am doing in any way worth the effort? Well only, if it receives a light from above. And if that happens,--why should I take care, not to be robbed of the fruits of my labour? If what I write really has value, how were anyone to steal the value from me? If the light from above is *lacking*, then I can in any case be no more than clever. MS 134 95: 3.4.1947

I completely understand, how someone may *hate* it, if the priority of his invention or discovery is called in question, how†a he may be willing to defend†b this priority with tooth & claw. *And yet* it is only a chimera. To be sure it seems to me too cheap, all too easy for *Claudius* to scoff at the priority disputes between Newton & Leibniz; but I think it is true all the same that this quarrel springs only from vile weaknesses & is nourished by VILE people. *What* would Newton have lost if he had acknowledged Leibniz's originality? Absolutely nothing! He would have gained a lot. And yet, how hard is such an acknowledgement, seeming,†c to someone who attempts it, like a confession of his own incapacity. Only people who esteem one, & at the same time *love* one, can make such behaviour†d *easy* for one.†e

It's a question of *envy* of course. And anyone who feels it, ought to keep saying to himself: 'It's a mistake! It's a mistake!--'

MS 134 100: 4.4.1947

In the train of every idea that costs a lot come a host of cheap ones: amongst them even a few that are useful.

Sometimes one sees ideas, as an astronomer sees stars in the far distance. (Or at least it seems so.) MS 134

If I had written a *good* sentence, & they were by accident two rhyming lines, †f†g†h this would be a *blemish*.

There is *much* that could be learned from Tolstoy's false†a theorizing that the work of art conveys 'a feeling'.--And you really might call it, if not the expression of a feeling, an expression of feeling, or a felt expression. And you might say too that people who understand it to that extent 'resonate' with it, respond to it. You might say: The work of art does not seek to convey *something else*, just itself. As, if I pay someone a visit, I don't wish simply to produce such & such feelings in him, but above all to pay him a visit, & naturally I also want to be well received.

And it does start to be really absurd, to say, the artist wishes that, what he feels when writing, the other should feel when reading. Presumably I can think I understand a poem (e.g.), understand it in the way its author would wish,--but what *he* may have felt in writing it, that doesn't concern me *at all*. MS 134 106: 5.4.1947

Just as I cannot write verse, so too I can write prose only *up to a certain point*, & no further. There is a quite definite limit to my prose, & I can no more overstep *it*, than I would be able to write a poem. *This* is how my equipment is constituted; it is the only equipment available to me. It is like someone's saying: In this game I can attain only *this* level of perfection, & not *that*. MS 134 108: 5.4.1947

It is *possible*†b, that everyone who executes an important work, sees before his mind's eye, dreams of, a continuation of, a sequel to, his work; but it would be remarkable all the same if it really turned out as he dreamed. Nowadays not believing in your own dreams is of course easy. MS 134 120: 7.4.1947

Nietzsche writes somewhere, †40 that even the best poets & thinkers have written mediocre & bad stuff, but have just separated off the good. But it is not quite like that. It's true that along with the roses a gardener has manure & *sweepings* & *straw* in his garden, but they are distinguished not only†c by value, but above all too by†d function in the garden.

What looks like a bad sentence can be the *germ* of a good one. MS 134 124: 8.4.1947

The faculty of 'taste' cannot create a new organism, only rectify one that is already there. Taste loosens screws & tightens screws, it doesn't create a new original work.†41

Taste rectifies, it doesn't give birth.†a

Taste makes ACCEPTABLE.

(Hence, I think, a great creator needs no†b taste: the child is born into the world well formed.)

Polishing is *sometimes* the job of taste, sometimes not.

I have taste.

The†c *most refined* taste has *nothing* to do with creative power.

Taste is refinement of sensibility; but sensibility does not *act*, it merely assimilates.

I *cannot*†d judge whether I have only taste, or originality as well. The former I can see distinctly, but not the latter, or only quite indistinctly. And perhaps it has to be like that, & you see only what you *have*, not what you are. Someone who does not lie is original enough. For, after all, the originality that would be worth wishing for, cannot be a sort of trick, or an idiosyncrasy, however marked.

In fact it is already a seed of good originality not to want to be what you are not. And all that has been said before *much* better by others.

Taste can delight, but not seize.

MS 134 129: 9.4.1947

You can as it were restore an old style in a new†e language; perform it afresh so to speak in a manner†f that†g suits

our times. In doing so you really only reproduce. I have done this in my building work.

Page Break 69

Page 69

What I mean is *not* however giving an old style a new trim. You don't take the old forms & fix them up to suit today's taste. No, you are really †a speaking, maybe unconsciously, the old language, but speaking it in a manner that belongs to the newer world, though not on that account necessarily one that is to its taste. MS 134 133: 10.4.1947

Page 69

Someone reacts *like this*: he says "Not *that!*"--& resists it. Out of this situations perhaps develop which are equally intolerable; & perhaps by then strength for any further revolt is exhausted. We say "If *he* hadn't done *that*, the evil would not have come about." But with what justification? Who knows the laws according to which society unfolds? I am sure even the cleverest has no idea. If you fight, you fight. If you hope, you hope. Someone can fight, hope & even believe, without believing *scientifically*.

Page 69

Science: enrichment & impoverishment. The *one* method elbows all others aside. Compared with this they all seem paltry, preliminary stages at best. You must climb down to the sources to see them all side by side, the disregarded & the preferred. MS 134 141: 13.4.1947

Page 69

Is it just *I* who cannot found a school, or can a philosopher never do so? I cannot found a school, because I actually want not to be imitated. †i In any case not by those who publish articles in philosophical journals.

Page 69

The use of the word "fate". Our attitude to the future & the past. To what extent do we hold ourselves responsible for the future? How much do we speculate about the future? How do we think about past & future? If something unwelcome happens:--do we ask "Who's to blame?", do we say "Someone must be to blame for it"?,--or do we say "It was God's will", "It was fate"?

In the way in which asking a question, insisting on an answer, or not asking it, expresses a different attitude, a different way of living, *so* too, in this sense, an utterance like "It is God's will" or "We are not masters of our fate". What this sentence does, or at least something similar, a commandment

Page Break 70

too could do. Including one that you give to yourself. And conversely a commandment, e.g. "Do not grumble!" can be uttered like the affirmation of a truth.

Now why am I so anxious to keep apart these ways of using "declarative sentences"? Is it really necessary? Did people in former times really not properly understand what they wanted to do with a sentence? Is it pedantry?--It is simply an attempt to see that every usage gets its due. Perhaps then a reaction against the overestimation of science. The use of the word "science" †i for "everything that can be said without nonsense" already betrays this over-estimation. For this amounts in reality to dividing utterances into two classes: good & bad; & the danger is already there. It is similar to dividing all animals, plants & rocks into the useful & the harmful.

But of course the words "see that they get their due" & "overestimation" express my point of view. I could have said instead: "I want to help this & this to regain respect."; only I don't see it like that.

Page 70

Fate is the antithesis of natural law. A natural law is something you try to fathom, & make use of, fate is not.

Page 70

It is not by any means clear to me, that I wish for a continuation of my work by others, more than a change in the way we live, making all these questions superfluous. (For this reason I could never found a school.)

Page 70

The philosopher says "Look at things *like this!*"--but first, that is not to say that people will look at things like this, second, he may be altogether too late with his admonition, & it's possible too that such an admonition can achieve absolutely nothing & that the impulse towards such a change in the way things are perceived must come from another direction. For instance it is quite unclear whether Bacon started anything moving, except the surface of his readers' minds.

Page 70

Nothing seems to me more unlikely than that a scientist or mathematician, who reads me, should be seriously influenced thereby in the way he works. (In that respect my warnings †a are like the posters on the ticket offices at English railway stations †42 "Is your journey really necessary?" As if anyone

Page Break 71

Page 71

reading that would say to himself "On second thoughts, *no*"†i.) Quite different artillery is needed here from anything I am in a position to muster. Most likely I could still achieve an effect in that, above all, a *whole lot* of garbage is written in response to†a my stimulus & that *perhaps* this provides†b the stimulus for something good. I ought always to hope only for the most indirect of influences.

Page 71

E.g. nothing more stupid than the chatter about cause & effect in history books; nothing more wrong-headed, more half-baked.--But who could put a stop to it by *saying* that? (It is†c as though I wanted to change men's and women's fashions†d by talking.) MS 134 143: 13.-14.4.1947

Page 71

Think about how it was said of Labor's playing "*He is speaking*". How curious! What was it about this playing that was so reminiscent of speaking? And how remarkable that this†e similarity with speaking is not something we find incidental, but an important & big matter!--We should like to call music, & certainly *some* music, a language; but no doubt not *some* music.†f (Not that this need involve a judgement of value!) MS 134 156: 11.5.1947

Page 71

The book is full of life--not like a human being, but like an ant-heap. MS 134 157: 11.5.1947

Page 71

One keeps forgetting to go down to the foundations. One doesn't put the question marks *deep* enough down.

Page 71

The labour pains at the birth of new concepts. MS 134 180: 27.6.1947

Page 71

"Wisdom is grey." Life on the other hand & religion are full of colour. MS 134 181: 27.6.1947

Page Break 72

It may be that science & industry, & their progress, are the most enduring thing in the world today. That any guess at a coming collapse of science & industry were†a for now, & for a *long* time to come, simply a dream, & that science & industry after†43 & with infinite misery will unite the world, I mean integrate it into a single empire, in which†i to be sure peace is the last thing that will then find a home.

For science & industry do decide wars, or so it seems. MS 135 14: 14.7.1947

Page 72

Do not interest yourself in what, presumably, only you are doing! MS 135 23: 16.7.1947

Page 72

My thoughts probably move in a far narrower circle than I suspect! MS 135 85: 24.7.1947

Page 72

Thoughts rise to the surface slowly, like bubbles.

Page 72

Sometimes it's as though you could see a thought, an idea, as an indistinct point far away on the horizon; & then it often comes closer†b with surprising speed. MS 135 101: 26.7.1947

Page 72

Where there is bad management in the state, I believe, bad management is fostered in families too. A worker who is ready for a strike†44 at any time will not bring up his children to respect order either. MS 135 102: 27.7.1947

Page 72

God grant the philosopher insight into what lies in front of everyone's eyes. MS 135 103 c: 27.7.1947

Page 72

Life is like a path along a mountain ridge; right & left smooth†c slopes down which you slide in this or that†d direction without being able to stop yourself. I keep seeing people slip like this & I say: "How could anyone help himself in that situation!" And *that* is what "denying free will" comes to. That is the attitude that expresses itself in this 'belief'. But it is not a *scientific* belief, has nothing to do with scientific convictions.

Page Break 73

Page 73

Denying responsibility means, not *holding* anyone responsible. MS 135 110: 28.7.1947

Page 73

Some people have a taste that is related to an educated taste as is the visual impression of a purblind eye to that of a normal eye. Where a normal eye see clear articulation, the weak one sees blurred patches of colour. MS 135 133: 2.8.1947

Page 73

Someone who knows too much finds it hard not to lie. MS 135 191: 17.12.1947

Page 73

I am so afraid of someone's playing the piano in the house that, when it happens & the strumming has stopped, I still have a sort of hallucination, that it's continuing. I can hear it then quite clearly, although I know that it is all in my imagination. MS 135 192: 17.12.1947

Page 73

It appears to me as though a religious belief could only be (something like) passionately committing oneself to a system of coordinates†a. Hence although it's belief, it is really a way of living, or a way of judging life. Passionately taking up *this* interpretation. And so instructing in a religious belief would have to be portraying, describing that system of reference & at the same time appealing to the conscience. And these together would have to result finally in the one under instruction himself, of his own accord, passionately taking up that system of reference. It would be as though someone were on the one hand to let me see my hopeless situation, on the other depict the rescue-anchor†b, until of my own accord, or at any rate not†c†d led by the hand by the *instructor*, I were to rush up & seize it.†45 MS 136 16b: 21.12.1947

Page 73

Perhaps one day a culture will arise out of this civilization.

Then there will be a real history of the discoveries of the 18th, 19th & 20th centuries, which will be of profound interest. MS 136 18b: 21.12.1947

Page 73

In the course of a scientific investigation we say all kinds of things; we make many utterances the role of which in our investigation we do not

Page Break 74

understand. For of course not everything we say has a conscious purpose, but our tongues just keep going. Our thoughts run in established routines, we make, automatically, transitions†a according to the techniques†b we have learned. And now comes the time for us to survey what we have said. We have made a whole lot of movements that do not further our purpose, even impede it, and now we have to clarify our thought processes philosophically. MS 136 31a: 24.12.1947

Page 74

It seems to me I am still a long way from understanding these things; from the point, that is, at which I know what I have to talk about, & what I don't need to talk about. I still keep getting entangled in details without knowing whether I ought to be talking about such things at all; & I have the impression that I may be inspecting a large area, simply to exclude it eventually from consideration. But even in this case these reflections would not be worthless; as long, that is, as they are not just going round in a circle. MS 136 37a: 25.12.1947

Page 74

Architecture glorifies something (because it endures).†c It glorifies its purpose.

Page 74

(...)

Page 74

Architecture immortalizes & glorifies something. Hence there can be no architecture where there is nothing (to immortalize &) glorify.

Page 74

(...)

Page 74

Architecture immortalizes & glorifies something. Hence there can be no architecture where there is nothing to glorify.

Page 74

Architecture glorifies something (because it endures). Hence there can be no architecture where there is nothing to glorify. MS 167 10v: ca. 1947-1948

Page 74

When philosophizing you have to descend into the old chaos†i & feel at home there. MS 136 51a: 3.1.1948

Page Break 75

Genius is talent in which character makes itself heard. For that reason, I would like to say, Kraus has talent, an extraordinary talent, but not genius.

To be sure, there are flashes of genius where, despite the *great* application of talent, you do not notice the talent. Example: "For the ox & the ass can do things too..."†46 It is curious that this e.g. is so much greater than anything Kraus ever wrote. Here you see not merely an intellectual skeleton, but a whole human being.

That is the reason too why the greatness of what someone writes depends on everything else he writes & does. MS 136 59a: 4.1.1948

Page 75

In a dream, & even *long* after we wake up, dream words can seem to us to have the greatest significance. Isn't the same illusion possible too in waking life? It seems to me as though *I* am sometimes subject to it these days. It often appears to be like this with the insane. MS 136 60b: 4.1.1948

Page 75

What I am writing here may be feeble stuff; well, in that case I am just not capable of getting out the big, important thing. But there are great prospects hidden in these feeble remarks. MS 136 62a: 4.1.1948

Page 75

Schiller writes in a letter (to Goethe, I think)†47 of a 'poetic mood'. I think I know what he means, I think I am familiar with it myself. It is the mood of receptivity to nature & one in which one's thoughts seem as vivid as nature itself. But it is strange that Schiller did not produce anything better (or so it seems to me) & so I am furthermore not entirely convinced that what *I* produce in such a mood is worth anything. It is quite possible that what gives my thoughts their lustre on such occasions is a light that they receive from *behind* them. That they do not *themselves* glow.

Page 75

Where others go on ahead, I remain standing. MS 136 80a: 8.1.1948

Page 75

[For the Foreword.]†48 It is not without†a reluctance that I offer the book to the public. The hands into which it will fall are for the most part not those in which I like to imagine it. May it soon--this is what I wish for it--be completely forgotten by the philosophical journalists & thus perhaps be kept for a more upright†b kind of reader. MS 136 81a: 8.1.1948

Page Break 76

Only every so often does one of the sentences I am writing here make a step forward; the rest are like the snipping of the barber's scissors, which he has to keep in motion so as to be able to make a cut with them at the right moment. MS 136 81b: 8.1.1948

Page 76

As I again & again come across questions in more remote regions that I cannot answer, it becomes clear†a why I still cannot find my way round regions that are less remote. For how do I know that what stands in the way of an answer here is not precisely what prevents me from clearing away the fog over there? MS 136 89a: 10.1.1948

Page 76

Raisins may be the best part of a cake; but a bag of raisins is not better than a cake; & someone who is in a position to give us a bag full of raisins still cannot bake a cake with them, let alone do something better.

I am thinking of Kraus & his aphorisms, but of myself too & my philosophical remarks.

A cake is not as it were: thinned out raisins. MS 136 91b: 11.1.1948

Page 76

Colours are a stimulus to philosophizing. Perhaps that explains Goethe's passion for the theory of colours. Colours seem to present us with a riddle, a riddle that stimulates us,--not one that exasperates†i us. MS 136 92b: 11.1.1948

Page 76

Human beings can regard all the evil within them as blindness. MS 136 107a: 14.1.1948

Page 76

If it is true, as I believe, that Mahler's music is worthless, the question is what I think he should have done with his talent. For quite obviously it took *a string of very rare talents* to produce this bad music. Should he, say, have written his symphonies & burnt them? Or should he have done himself violence & not have written them? Should he have written them & realized that they were worthless? But how could he have realized that? I see it because I can

compare his music with that of the great composers. But *he* could not do that; for someone to whom that has occurred may perhaps have *misgivings* about the value of his production, because he no doubt sees that he does not, so to speak, have the nature of the other great

Page Break 77

composers,--but that does not mean that he will grasp the worthlessness; because he can always tell himself that he is, it is true, *different* from the rest (whom however he admires) but excellent in another way. We could perhaps say: If nobody whom you admire is like you, then presumably you believe in your own value only because you are *you*.--Even someone who struggles against vanity, but not entirely successfully, will always deceive himself about the value of what he produces.

But what seems most dangerous is to put your work into the position of being compared, first by yourself & then by others, with the great works of former times. You should not entertain such a comparison at all. For if today's circumstances are really so different, from what they once were, that you cannot compare your work with earlier works in respect of its *genre*, then you equally cannot compare its *value* with that of the other work. I myself am constantly making the mistake under discussion.

Incorruptibility is everything!

Page 77

Conglomeration: national sentiment, e.g. MS 136 110b: 14.1.1948*

Page 77

Animals come when their names are called. Just like human beings. MS 136 113a: 15.1.1948

Page 77

I ask countless irrelevant questions. If only I can beat my way through this forest! MS 136 117a: 15.1.1948

Page 77

Really I want to slow down the speed of reading with continual †a punctuation marks. For I should like to be read slowly. (As I myself read.) MS 136 128b: 18.1.1948

Page 77

I think Bacon got bogged down in his philosophy & this danger threatens me too. He had a vivid image of a huge building, it disappeared however when he really wanted to get down to details. It was as though his contemporaries had begun to build a great building from the foundations; & as though *he* had seen something similar in his imagination, the vision of such a building; had seen it as even more imposing than, perhaps, those who were working on the construction. For this an *inkling* of the method was necessary, but by no means a talent for building work. But the bad

Page Break 78

thing was that he launched polemical attacks against the real builders & either did not recognize, or did not want to recognize, *his* limitations.

On the other hand it is tremendously hard to see these limitations, & that means, to delineate them clearly. That is, as it were, to find †a a way of painting to depict this fuzziness. For I want to keep saying to myself: "Paint nothing more than what you see!" MS 136 129b: 19.1.1948

Page 78

In Freudian analysis the dream is as it were dismantled. It loses its original sense *completely*. You might think of it as performed on the stage, with a plot that is sometimes fairly incomprehensible but also in part quite comprehensible, or at least apparently so, & as though this plot were then torn into little pieces & each part given a completely different meaning. You could also think of it like this: a picture is drawn on a big sheet of paper & the sheet is then folded in such a way that pieces which do not belong together at all in the original picture collide in appearance & a new picture, which may make sense or may not, is formed (this would be the manifest dream, the first picture the 'latent dream thought').

Now I could imagine that someone, who sees the unfolded picture, might exclaim "Yes, that is the solution, that is what I dreamed, but without gaps & distortions." It would then be this acknowledgement that made this solution the solution. Just as, if you are searching for a word while writing & then say: "*That's it, that* says what I wanted to say!"--Your acknowledgement stamps the word as having been found, i.e. the one you were looking for. (In this case it might really be said: only when you have found it, do you know what you were looking for--much as Russell said about wishing.)

Page 78

What is intriguing about a dream, is not its *causal* connection with events in my life, etc., but rather this, that it

affects us like part of a story, †b & indeed a very *vivid* part, the rest lying in darkness. (We would like to say †c: "Where on earth did this image come from, & what has become of it?") Yes, and if someone now shows me that this story was not the right story; that in reality quite a different one underlay it, so that I want to say †d, disenchanted, "Oh, *that's* how it was?", I have seemingly really been robbed of something. Certainly, the first story now disintegrates, as the paper is unfolded; the man I saw was taken from *here*, his words from

Page Break 79

there, the surroundings in the dream from somewhere else again; but the dream story all the same has its own charm, like a painting that attracts & inspires us.

It can certainly be said that we *contemplate* the dream picture with inspiration, that we just *are* inspired. For if we tell the dream to someone else, the picture usually does not inspire him. The dream is like an idea pregnant with possible implications †a

MS 136 137a: 22.1.1948

Page 79

Strike a coin from every mistake.

MS 137 17a: 10.2.1948

Page 79

Understanding & explaining a musical phrase.--The simplest explanation is sometimes a gesture; another might be a dance step, or words describing a dance.--But isn't our understanding of the phrase an experience we have while hearing it? & what function, in that case, has the explanation? Are we supposed to think of *it* while we hear the music? Are we supposed to imagine the dance, or whatever it may be, as we listen? And supposing we do,--why should *that* be called hearing the music with understanding?? If seeing the dance is what matters, it would be better *that*, rather than the music, were performed. But that is all a misunderstanding.

I give someone an explanation, say to him: "It's as though..."; then he says "Yes now I understand it" or "Yes now I know how it is to be played". Above all he did not have to *accept* the explanation; it is not after all as though I had given him compelling reasons for comparing this passage with this & that. I did not e.g. explain to him that remarks made by the composer show that this passage is supposed to represent this & that.

Page 79

If I now ask "What do I actually experience then, if I hear the theme & hear it with understanding?"--nothing but inanities †b occur to me by way of reply. Such as images, kinaesthetic sensations, thoughts †c and the like. Sure enough I say "I go along with it"--but what does that mean? It *might* mean roughly that I accompany the music with gestures. And if we point out that after all this happens for the most part only in very rudimentary measure, we shall perhaps receive the answer that the rudimentary movements are supplemented with images. But let us nevertheless assume that someone does accompany the music with movements in full

Page Break 80

measure,--in what sense does *that* amount to understanding it? And do I want to say, the movements are the understanding; or his kinaesthetic sensations? (What do I know about them?)--What is true is, that, in certain circumstances, I shall regard his movements as signs of his understanding.

Page 80

But am I to say (if I reject images, kinaesthetic sensations, etc. as an explanation) that understanding is just a specific experience that cannot be analysed further? Well, that would be passable, as long as it is not supposed to mean, †a it is a specific *experiential content*. For *these* words make one think of distinctions like those between seeing, hearing & smelling. †b

Page 80

How then do we explain to someone what it means "to understand music"? By naming the images, kinaesthetic sensations, etc. experienced by someone who understands? *More likely*, by pointing out the expressive movements of one who understands.--Anyway, there is also the question, what function does explanation have here? & what does it mean: to understand what it means to understand music? Some indeed would say: to understand that means: to understand music oneself. And so the question would be "Then can we teach someone to understand music", for only that kind of teaching could be called an explanation of music.

Appreciation †c of music is *expressed* in a certain way, both in the course of hearing & playing and at other times †d too. This expression sometimes includes movements, but sometimes only the way the one who understands plays, or hums, occasionally too parallels he draws & images which, as it were, illustrate the music. Someone who understands music will listen differently (with a different facial expression, e.g.), play differently, hum differently, talk differently about the piece than someone who does not understand. His appreciation of a theme will not however be shown only in phenomena that accompany the hearing or playing of the theme, but also in an

appreciation for music in general.

Page 80

Appreciating music is a manifestation of human life. How could it be described to someone? Well, above all I suppose we should have to describe *music*. Then we could describe the relation human beings have to it. But is that all that is necessary, or is it also part of the process to teach

Page Break 81

him to appreciate it for himself? Well, developing his appreciation will teach him what appreciation is in a *different* sense, than a teaching that does not do this. And again, teaching him to appreciate poetry or painting can be part of an explanation of what music is. MS 137 20b: 15.2.1948

Page 81

Our children learn in school already that water *consists* of the gases hydrogen & oxygen, or sugar of carbon, hydrogen & oxygen. Anyone who does not understand is stupid. The most important questions are concealed. MS 137 30b: 8.3.1948

Page 81

The beauty of a star-shaped figure--of a hexagonal star perhaps--is spoiled if we see it as symmetrical relative to a given axis. MS 137 34b: 10.3.1948

Page 81

Bach said that everything he achieved was the result of industry. But industry like that presupposes humility & an enormous capacity for suffering, strength then. And anyone who in addition can express himself perfectly, simply addresses us in the language of a great human being. MS 137 40b: 28.5.1948

Page 81

I think that present day education of human beings aims at decreasing the capacity for suffering. Nowadays a school counts as good, if the children have a Good time. And formerly that was *not* the yardstick. And parents would like children to become the way they themselves are (only more so) & yet they give them an education which is *quite* different from their own.--Capacity for suffering is not rated highly, since there are not supposed to be any sufferings, really they are out of date.

Page 81

"The cussedness of things"--An unnecessary anthropomorphism. We might speak of a malice of the *world*; easily imagine the devil created the

Page Break 82

world, or part of it. And we need not imagine the demon intervening in particular situations; everything may happen 'in accordance with the laws of nature': it is just that the whole plan is directed at evil from the start. But a human being exists in this world in which things break, slide about, cause every possible mischief. And of course he is one of the things.--The 'malice' of the object is a stupid anthropomorphism. For the truth is much graver than this fiction. MS 137 42a: 30.5.1948

Page 82

A stylistic device may be useful & yet I may be barred from using it. Schopenhauer's "as which" e.g. It would sometimes make for much more comfortable, clearer expression, but cannot be used by someone who perceives it as archaic; & he must not disregard this perception. MS 137 43a: 30.5.1948

Page 82

Religious faith & superstition are quite different. The one springs from *fear* & is a sort of false science. The other is a trusting. MS 137 48b: 4.6.1948

Page 82

It would almost be strange if there did not exist animals with the mental life of plants. I.e. lacking mental life. MS 137 49a: 4.6.1948

Page 82

I think it might be regarded as a fundamental law of natural history that, whenever something in nature 'has a function', 'serves a purpose', the same thing also occurs in circumstances where it serves none, is even 'dysfunctional'.

If dreams sometimes protect sleep, you can count on their sometimes disturbing it; if dream hallucination sometimes serves a *plausible* end (imagined wish fulfilment), count on its doing the opposite as well. There is no 'dynamic theory of dreams'. MS 137 49b: 4.6.1948

Page 82

What is important about depicting anomalies precisely? If you cannot do it, that'd shows you do not know your way around the concepts. MS 137 51a: 15.6.1948

Page Break 83

I am too soft, too weak, & so too lazy, to achieve anything important. The industry of the great is, amongst other things, a sign of their *strength*, quite apart from their inner wealth. MS 137 54b: 25.6.1948

Page 83

If God really does *choose* those who are to be saved, there is no reason why he should not choose them according to their nationalities, races, or temperaments. Why the choice should not be expressed in the laws of nature. (He was of course also *able* so to choose, that the choice follows a law.)

I have been reading extracts from the writings of St. John of the Cross†50, in which it is written that people have gone to their ruin, because they did not have the good fortune to find a wise spiritual director at the right moment.

And how can you†a say then that God does not try people beyond their strengths?

I am inclined to say here, it is true, that crooked concepts have done a lot of mischief, but the truth is, that I do not know at all, what does good & what does mischief. MS 137 57a: 26.6.1948

Page 83

We must not forget: even our more refined, more philosophical, scruples have a foundation in instinct. E.g. the 'We can never know...' Remaining receptive to further arguments. People who couldn't be taught this would strike us as mentally inferior. *Still* incapable of forming a certain concept. MS 137 57b: 30.6.1948

Page 83

If the dreams of sleep have a similar function to daydreams, then they partly serve <to> prepare people for *any* eventuality (including the worst). MS 137 65b: 3.7.1948

Page 83

If someone can believe in God with complete certainty, why not in Other Minds? MS 137 67a: 3.7.1948

Page 83

This musical phrase is a gesture for me. It creeps into my life. I make it my own.

Page 83

Life's infinite variations are an essential part of our life. And so precisely of the habitual character of life. Expression consists for us <in> incalculability. If I knew exactly how he would grimace, move, there would be no facial expression, no gesture.--But is that true?--I can after all listen again

Page Break 84

& again to a piece of music that I know (completely) by heart; & it could even be played on†a a musical box. Its gestures would still remain gestures for me although I know all the time, what comes next. Indeed I may even be surprised afresh again & again. (In a certain sense.) MS 137 67a: 4.7.1948

Page 84

The honest religious thinker is like a tightrope walker. It almost looks as though he were walking on nothing but air. His support†b†i is the slenderest imaginable. And yet it really is possible to walk on it. MS 137 67b: 5.7.1948

Page 84

Unshakable faith. (E.g. in a promise.) Is it less certain than being convinced of a mathematical truth?--(But does that make the language games any more alike!) MS 137 70b: 7.7.1948

Page 84

It is important for our approach, that someone may feel concerning certain people, that he will never know what goes on inside them. He will never understand them. (Englishwomen for Europeans.) MS 137 71a: 9.7.1948

Page 84

I think it is an important & remarkable fact, that a musical theme, if it is played <at> (very) different tempi, changes its *character*. Transition from quantity to quality. MS 137 72b: 14.7.1948

Page 84

The problems of life are insoluble on the surface, & can only be solved in depth. In surface dimensions they are insoluble. MS 137: 73b: 25.7.1948

Page 84

In a conversation: One person throws a ball; the other does not know: is he to throw it back, throw it to a third person, or leave it lying, or pick it up & put it in his pocket, etc.. MS 137 75b: 23.8.1948

Page 84

A great architect in a bad period (Van der Nüll) has a quite different task from that of a great architect in a good

period. You must again not let yourself be deceived†c by the generic term. Don't take comparability, but rather incomparability, as a matter of course. MS 137 76a: 19.10.1948

Page Break 85

Nothing is more important though than the construction of fictional concepts,†a which will teach us at last to understand our own. MS 137 78b: 24.10.1948

Page 85

"Thinking is difficult." (Ward) What does that really mean? Why is it difficult?--It is almost like saying "Looking is difficult". For looking intently is difficult. And you may look intently & yet see nothing, or keep thinking you see something & yet not be able to see clearly†b. You can tire from looking, even if you see nothing. MS 137 81b: 27.10.1948

Page 85

If you cannot unravel a tangle, the most sensible thing you can do†c is to recognize this; & the most decent, to admit it. [Antisemitism.]

What you should do to cure the evil is *not* clear. What is *not* permissible is clear from one case to another. MS 137 88a: 4.11.1948

Page 85

It is remarkable that Busch's drawings can often be called 'metaphysical'. There is then a way of drawing that is metaphysical.--"Seen, with the eternal as background"†51 one might say. However these strokes mean this only in a whole language. And it is a language without grammar, you couldn't say what its rules are. MS 137 88b: 4.11.1948

Page 85

When he was old Charlemagne tried unsuccessfully to learn to write: & someone may be similarly unsuccessful in trying to learn a new line of thinking. He never becomes fluent in it. MS 137 89b: 5.11.1948

Page 85

A language, which is spoken in strict tempo, so that you can also speak according to the *metronome*. It does not go without saying that music can be performed, like ours, at least occasionally, to the metronome. (Playing the theme from the 8th Symph.†52 exactly according to the metronome.) MS 137 97b: 14.11.1948

Page 85

It would already be enough, that all members of a community had the same facial features, for us not to be able to fathom them. MS 137 97b: 16.11.1948

Page Break 86

If a false thought is so much as expressed boldly & clearly, a great deal has already been gained. MS 137 100a: 19.11.1948

Page 86

Only by thinking much more crazily even than the philosophers, can you solve their problems. MS 137 102a: 20.11.1948

Page 86

Imagine someone watching a pendulum & thinking: God makes it move like that. Well, doesn't God have the right†a even to act in accordance with a calculation?

Page 86

A writer far more talented than I would still have little talent. MS 137 104a: 21.11.1948

Page 86

Human beings have a *physical* need to tell themselves when at work: "Let's have done with it now", & it's having constantly to go on thinking in the face of this need when philosophizing, that makes this work so strenuous. MS 137 104b: 22.11.1948

Page 86

You must *accept* the faults in your own style. Almost like the blemishes in your own face. MS 137 106b: 23.11.1948

Page 86

Always come down from the barren heights of cleverness into the green valleys of folly. MS 137 111b: 28.11.1948

Page 86

I have one of those talents that has constantly to make a virtue out of necessity.

Page 86

Tradition is not something that anyone can pick up, it's not a thread, that someone can pick up, if & when he pleases; any more than you can choose your own ancestors.

Someone who has no tradition & would like to have it, is like an unhappy lover.

Page 86

The happy lover & the unhappy lover both have their particular pathos.

But it is harder to bear yourself well as an unhappy lover than as a happy one. MS 137 112b: 29.11.1948

Page Break 87

Moore poked into a philosophical wasp nest with his paradox; & if the wasps did not duly fly out, that's only because they were too listless. MS 137 120a: 10.12.1948

Page 87

In the realm of the mind a project can usually not be begun again, nor should it be. These thoughts fertilize the soil for fresh thoughts. MS 137 122a: 11.12.1948

Page 87

Are you a bad philosopher then, if what you write is hard to understand. If you were better, then you would make it easy to understand what is difficult.--But who says that is possible?! [Tolstoy] MS 137 127a: 16.12.1948

Page 87

The greatest happiness for a human being is love. Suppose you say of the schizophrenic: he does not love, he cannot love, he refuses to love--where is the difference?

Page 87

"He refuses to..." means: it is in his power. And *who* wants to say that?!

Page 87

Well, of what do we say "it is in his power"?--We say it in cases where we want to draw a distinction. I can lift *this* weight, but I will not lift it; *that* weight I cannot lift.

Page 87

"God has commanded it, therefore we must be able to do it." That means nothing. There is no "*therefore*" about it. The two expressions might at most mean the *same*.

Page 87

"He has commanded it" means here roughly: He will punish anyone who does not do it. And nothing follows from that about being able. And *that* is the sense of 'election by grace'.

Page 87

But that does not mean that it is right to say: "He punishes, although we *cannot* act otherwise."--Perhaps, though, one might say: here there is punishment, where punishment by human beings would be impermissible. And the whole concept of 'punishment' changes here. For the old illustrations can no longer be applied, or now have to be applied quite differently. Just look at an allegory like "The Pilgrim's Progress" & see how nothing

Page Break 88

--in human terms--is right.--But isn't it right all the same? i.e. can it not be applied? Indeed, it has been applied. (At railway stations there are dials with two hands, they indicate when the next train leaves. They look like clocks & aren't; but they have a use.) (There should be a better comparison here.)

Page 88

To someone who is upset by this allegory it might be said: Apply it differently or don't bother with it! (But *some* will be far more confused than helped by it.) MS 137 130a: 22.12.1948

Page 88

Anything the reader can do for himself, leave it to the reader. MS 137 134b: 25.12.1948

Page 88

Almost the whole time I am writing conversations with myself. Things I say to myself tête-à-tête. MS 137 134b: 26.12.1948

Page 88

Ambition is the death of thought. MS 137 135a: 27.12.1948

Page 88

Humour is not a mood, but a way of looking at the world. So, if it's right to say that humour was eradicated in Nazi Germany, that does not mean that people were not in good spirits or anything of that sort, but something much deeper & more important. MS 137 135a: 28.12.1948

Page 88

Two people who are laughing together, at a joke perhaps. One of them has said †c certain somewhat unusual words & now they both break out into a sort of bleating. That might appear *very* bizarre to someone arriving among us from a quite different background. Whereas we find it quite *reasonable*.

(I witnessed this scene recently on a bus & was able to think myself into the skin of someone not accustomed to it. It struck me then as quite irrational & like the reactions of an outlandish *animal*.) MS 137 136b: 31.12.1948

Page 88

Recounting a dream, a medley of recollections. Often forming a significant & enigmatic whole. As it were a fragment, that makes a *powerful* impression on us (*sometimes* that is), so that we look for an explanation, for connections.

Page Break 89

Page 89

But why did *these* recollections come *now*? Who will say?--It may be connected with our present life, and so too with our wishes, fears, etc. "But do you mean to say that this phenomenon must exist in the particular causal interconnection?"--I mean to say that it does not necessarily make sense to speak of discovering its cause.

Page 89

Shakespeare & the dream. A dream is all wrong, absurd, composite, & yet completely right: in *this* strange concoction it makes an impression. Why? I don't know. And if Shakespeare is great, as he is said to be, then we must be able to say of him: Everything is wrong, things *aren't like that*--& is all the same completely right according to a law of its own.

It could be put like this too: If Shakespeare is great, then he can be so only in the whole *corpus* of his plays, which create their *own* language & world. So he is completely unrealistic. (Like the dream.) MS 168 1r: January 1949

Page 89

If Christianity is the truth, then all the philosophy about it is false. MS 169 58v: 1949

Page 89

Culture is an observance. Or at least presupposes an observance. MS 169 62v: 1949

Page 89

The concept of a 'festivity'. Connected for us with merrymaking; perhaps in another age only with fear & dread. What we call "wit" & what we call "humour" doubtless did not exist in other ages. And both these are perpetually †a changing. †b MS 137 137a: 1.1.1949

Page 89

"Le style c'est l'homme." "Le style c'est l'homme même." The first expression has a cheap epigrammatic brevity. The second, correct, one opens up a quite different perspective. It says that style is the *picture* of the man.

Page 89

There are remarks that sow, & remarks that reap. MS 137 140a: 4.1.1949

Page Break 90

To piece together †a the landscape of these conceptual relationships out of their individual fragments †b is *too difficult* for me. I can make only a very imperfect job of it. MS 137 141a: 6.1.1949

Page 90

If I prepare myself for some eventuality, you can be pretty sure that it won't happen. Perhaps. †i

Page 90

It is *difficult* to know something, & to act as though you didn't know it. MS 137 143a: 7.-8.1.1949

Page 90

There really are cases in which one †c has the sense of what one †d wants to say much more clearly in mind than he †e †54 can express in words. (This happens to me very often.) It is as though one remembered a dream very clearly, but could not give a good account of it. †f Indeed the image often stays there behind the words for the writer (me), so that they *seem* to describe it *to me*.

Page 90

A mediocre writer must beware of too quickly replacing a crude, incorrect expression with a correct one. By doing so he kills the original idea, which was still at least a living seedling. And now it is shrivelled & no longer worth *anything*. He may now just as well throw it on the rubbish heap. Whereas the pitiful seedling still had a certain usefulness. MS 138 2a: 17.1.1949

Page 90

That writers, who after all *were* something, go out of date is connected with the fact that their writings, when

complemented by the setting of their own age, speak strongly to people, but that they die without this complementation, as if bereft of the lighting that gave them colour.

And I believe that the beauty of mathematical demonstrations, as experienced by Pascal too, is connected with this. Within *this* way of

Page Break 91

looking at the world these demonstrations did have *beauty*--not what superficial people call beauty. A crystal too is not beautiful in every 'setting'--though perhaps everywhere *attractive*--

Page 91

The way whole periods are incapable of freeing themselves from the grip of certain concepts--e.g. the concept 'beautiful' & 'beauty'. MS 138 3a: 18.1.1949

Page 91

My own thinking about art & values is far more disillusioned, than would have been *possible* for people 100 years ago. However that does not mean that it is more correct on that account. It only means that there are examples of decline in the forefront of my mind, which were not in the *forefront* for those people then. MS 138 4a: 18.1.1949

Page 91

Troubles are like illnesses; you have to put up with them: the worst thing you can do is, rebel against them. They come in attacks too, triggered by inner, or outer causes. And then you must tell yourself: "Another attack". MS 138 4b: 19.1.1949

Page 91

Scientific questions may interest me, but they never really grip†a me. Only *conceptual & aesthetic* questions have that effect on me. At bottom it leaves me cold whether scientific problems are solved; but not those other questions. MS 138 5b: 21.1.1949

Page 91

Even if we are not thinking in circles, still, we sometimes walk straight through the thicket of questions out into the open country, sometimes†b along tortuous, or zigzagging paths, which don't take us into the open country. MS 138 8a: 22.1.1949

Page 91

The Sabbath is not simply a time to rest, to recuperate. We are supposed to look at our work from the outside, not just from within. MS 138 8b: 23.1.1949

Page 91

This is how philosophers should salute each other: "Take your time!" MS 138 9a: 24.1.1949

Page Break 92

Page 92

For a human being the eternal, the consequential is often hidden behind an impenetrable veil. He knows: there is something under there, but he cannot *see* it; the veil reflects the daylight. MS 138 9a: 24.1.1949

Page 92

Why shouldn't someone become desperately unhappy? It is one human possibility. As in 'Corinthian Bagatelle', this is one of the possible paths for the balls. And perhaps not even one of the rarest. MS 138 9b: 25.1.1949

Page 92

The valleys of foolishness have more grass growing in them for the philosopher than do the barren heights of cleverness. MS 138 11a: 28.1.1949

Page 92

Isochronism according to the clock & isochronism in music. They are by no means equivalent concepts. Playing in *strict* time, does not mean playing exactly according to the metronome. But it would be possible that a certain *kind* of music should be played according to the metronome. (Is the opening theme <of the second movement> of the 8th symphony of this kind?) MS 138 12a: 30.1.1949

Page 92

Could the concept of the punishments of hell be explained in some other way than by way of the concept of punishment? Or the concept of God's goodness in some other way than by way of the concept of goodness? If you want to achieve the right *effect* with your words, doubtless not.

Page 92

Suppose someone were taught: There is a being who, if you do this & that, live in such & such a way, will take you

after your death to a place of eternal torment; most people end up there, a few get to a place of eternal joy.--This being has picked out in advance those who are to get to the good place; &, since only those who have lived a certain sort of life get to the place of torment, he has also picked out in advance those who are to lead that sort of life. What might be the effect of such a doctrine?

Page 92

Well, there is no mention of punishment here, but rather a kind of natural law. And anyone to whom it is represented in such a light, could derive only despair or incredulity from it.†a

Page Break 93

Page 93

Teaching this could not be an ethical training. And if you wanted to train anyone ethically & yet teach him like this, you would have to teach the doctrine *after* the ethical training, and represent it as a sort of incomprehensible mystery. MS 138 13b: 2.2.1949

Page 93

"He has chosen them, in his goodness, & you he will punish" really makes no sense. The two halves belong to different kinds of perspective. The second half is ethical & the first not. And taken together with the first the second is absurd. MS 138 14a: 2.2.1949

Page 93

It is an accident that 'last' rhymes with 'fast'.†i But a lucky accident, & you can *discover*†a this lucky accident. MS 138 25a: 25a: 22.2.1949

Page 93

In Beethoven's music what one might call the expression of irony is to be found for the first time. E.G. in the first movement of the Ninth. With him, moreover, it is a terrible irony, that of fate perhaps.--In Wagner irony reappears, but turned into something bourgeois.

You could no doubt say that Wagner & Brahms, each in his own way, imitated Beethoven; but what with him was cosmic, is†b earthly with them.

The same expressions are to be found in him, but they follow different laws.

Page 93

In Mozart's or Haydn's music again fate plays no sort of role. That is not the *concern* of this music.

That ass Tovey says somewhere that this, or something similar, is connected with the fact that Mozart has no access to literature of a certain sort. As though it were established, that only books had made the music of the masters what it was. Naturally, books & music are connected. But if Mozart found no great *tragedy* in his reading, does that mean that he did not find it in his *life*? And do composers always see solely through the spectacles of poets? MS 138 28a: 27.2.1949

Page 93

Only in a quite particular musical context is there such a thing as three-part counterpoint. MS 138 28b: 27.2.1949

Page Break 94

Soulful expression in music. It is not to be described in terms of degrees of loudness & of tempo. Any more than is a soulful facial expression describable in terms of the distribution of matter in space. Indeed it is not even to be explained by means of a paradigm, since the same piece can be played with genuine expression in innumerable ways. MS 138 29a: 1.3.1949

Page 94

God's essence is said to guarantee his existence--what this really means is that here what is at issue is not the existence of something.

Page 94

For could one not equally say that the essence of colour guarantees its existence? As opposed, say, to the white elephant. For it really only means: I cannot explain what 'colour' is, what the word "colour" means, without the help of a colour sample. So in this case there is no such thing as explaining 'what it *would be like* if colours *were* to exist'.

Page 94

And now we might say: There can be a description of what it would be like if there were gods on Olympus--but not: 'what it would be like if there were God'. And this determines the concept 'God' more precisely,

Page 94

How are we taught the word "God" (its use, that is)? I cannot give an exhaustive systematic description. But I can as it were make contributions towards the description; I can say something about it & perhaps in time assemble a sort

of collection of examples.

Page 94

Reflect in this connection that in a dictionary one would perhaps like to give such descriptions of use, but in reality one gives only a few examples & explanations. But also that no more than this is necessary. What use could we make of an enormously long description?--Well, it would be no use to us if it dealt with the use of words in languages already familiar to us. But what if we came across such a description of the use of an Assyrian word? And in what language? Let's say in another language already known to us.--In this description the word "sometimes" will frequently occur, or "often", or "usually", or "nearly always" or "almost never".

Page 94

It is difficult to form a good picture of a description of this sort.

Page Break 95

And what I basically am after all is a painter, & often a very bad painter. MS 138 30b: 17.3.1949

Page 95

What is it like when people do not have the same sense of humour? They do not react properly to each other. It is as though there were a custom among certain people to throw someone a ball, which he is supposed to catch & throw back; but certain people might not throw it back, but put it in their pocket instead.

Page 95

Or what is it like for someone to have no idea how to fathom another's taste? MS 138 32b: 20.5.1949

Page 95

A picture that is firmly rooted in us may indeed be compared to superstition, but it may be said too that we *always* have to reach some sort of firm ground, be it a picture, or not, so that a picture at the root of all our thinking is to be respected & not treated as a superstition. MS 138 32b: 20.5.1949

Page 95

It is not unheard of†a that†b someone's character may be influenced by the external world (Weininger). For that only means that, as we know from experience, people change with circumstances. If someone asks: How *could* the environment *coerce* someone, the ethical in someone?--the answer is that he may indeed say "No human being has to give way to coercion", †i but all the same under such circumstances†c someone *will* do such & such.

'You don't HAVE to, I can show you a (different) way out,--but you won't take it.' MS 173 17r: 30.3.1950

Page 95

I do not think that Shakespeare can be set alongside any other poet.

Was he perhaps a *creator of language* rather than a poet?

Page 95

I could only stare in wonder at Shakespeare; never do anything with him.

Page 95

I am *deeply* suspicious of most of Shakespeare's admirers. I think the trouble is that, in western culture at least, he stands alone, & so, one can only place him by placing him wrongly.

Page Break 96

It is *not* as though S. portrayed human types well & were in that respect *true to life*. He is *not* true to life. But he has such a supple hand & such individual *brush strokes*. [[sic , ?]] that each one of his characters looks *significant*, worth looking at.

Page 96

"Beethoven's great heart"--no one could say "Shakespeare's great heart". The supple hand that created new natural forms of language' would seem to me nearer the mark.

Page 96

The poet cannot really say of himself "I sing as the bird sings"--but perhaps S. could have said it of himself. MS 173 35r: 12.4.1950 or later

Page 96

One & the same theme has a different character in the minor than in the major, but it is quite wrong to speak generally of a character belonging to the minor. (In Schubert the major often sounds sadder than the minor.†a) And similarly, I think, it is idle & futile for the understanding of painting to speak of the characters of the individual colours. In doing so one really thinks only of special applications. The fact that green has one effect as the colour of a table cloth, red another, licenses no conclusion about their effect in a picture. MS 173 69r: 1950

Page 96

I do not think Shakespeare could have reflected on the 'lot of the poet'.

Neither could he regard himself as a prophet or teacher of humanity.

People regard him with amazement almost as a spectacle of nature. They do not have the feeling that this brings them into contact with a great *human being*. Rather with a phenomenon.

I think that, in order to enjoy a poet, you have to *like* the culture to which he belongs as well. If you are indifferent to this or repelled by it, your admiration cools off. †bMS 173 75v: 1950

If the believer in God looks around & asks "Where does everything I see come from?" "Where does all that come from?", what he hankers after is

not a (causal) explanation; and the point of his question is that it is the expression of this hankering. †i He is expressing, then, a stance †a towards all explanations.--But how is this manifested in his life?

It is the attitude of taking a certain matter seriously, but then at a certain point not taking it seriously after all, & declaring that something else is still more serious.

Someone may for instance say that it is a very grave matter that such & such a person has died before he could complete a certain piece of work; & in another sense that is not what matters. At this point one uses the words "in a deeper sense".

Really what I should like to say is that here too what is important is not the *words* you use or what you think while saying them, so much as the difference that they make at different points in your life. How do I know that two people mean the same thing when each says he believes in God? And just the same thing goes for the Trinity. Theology that insists on *certain* †b words & phrases & prohibits others makes nothing clearer. (Karl Barth)

It gesticulates with words, as it were, because it wants to say something & does not know how to express it. †c *Practice* gives the words their sense. MS 173 92r: 1950

A proof of God ought really to be something by means of which you can convince yourself of God's existence. But I think that *believers* who offered such proofs wanted to analyse & make a case for their 'belief' with their intellect, although they themselves would never have arrived at belief by way of such proofs. "Convincing someone of God's existence" is something you might do by means of a certain upbringing, shaping his life in such & such a way. Life can educate you to "believing in God". And *experiences* too are what do this but not visions, or other sense experiences, which show us the "existence of this being", but e.g. sufferings of various sorts. And they do not show us God as a sense experience does an object, nor do they give rise to *conjectures* about him. Experiences, thoughts,--life can force this concept on us.

So perhaps it is similar to the concept 'object'.

MS 174 1v: 1950

The reason I cannot understand Shakespeare is that I want to find symmetry in all this asymmetry.

It seems to me as though his pieces are, as it were, enormous *sketches*, not paintings; as though they were *dashed off* by someone who could permit himself *anything*, so to speak. And I understand how someone may admire this & call it *supreme art*, but I don't like it.--So I can understand someone who stands before those pieces speechless; but someone who admires him as one admires Beethoven, say, seems to me to misunderstand Shakespeare. MS 174 5r: 24.4.1950 or later

One age misunderstands another; and a *petty* age misunderstands all the others in its own ugly way. MS 174 5v: 1950

How God judges people is something we cannot imagine at all. If he really takes the strength of temptation & the frailty of nature into account, whom can he condemn? But if not, then these two forces simply yield as a result the end for which this person was predestined. In that case he was created so as either to conquer or succumb as a result of the interplay of forces. And that is not a religious idea at all, so much as a scientific hypothesis.

So if you want to stay within the religious sphere, you must *struggle*. MS 174 7v: 1950

Look at human beings: One is poison for the other. A mother for her son, and vice versa, etc. etc. But the mother is blind & the son too. Perhaps they have a guilty conscience, but what good does that do them? The child is wicked, but nobody teaches it to be different, & the parents only spoil it with their foolish affection; & how are they supposed to understand this, & how is the child to understand it? They are, so to speak, *all* wicked & *all* innocent. MS 174 8r: 1950

Page 98

Philosophy hasn't made any progress?--If someone scratches where it itches, do we have to see progress? isn't it genuine scratching otherwise, or genuine itching? And can't this reaction to the irritation†a go on†b like this for a long time, before a cure for the itching is found? MS 174 10r: 1950

Page Break 99

Page 99

God may say to me: "I am judging you out of your own mouth. You have shuddered with disgust at your own actions when you have seen them in other people". MS 175 56r: 15.3.1951

Page 99

Is the sense of belief in the Devil this, that not everything that comes to us as an inspiration is good†a? MS 175 63v: 17.3.1951

Page 99

You cannot judge yourself, if you are not versed in the categories. (Frege's style of writing is sometimes *great*; Freud writes excellently, & it is a pleasure to read him, but his writing is never *great*)†55 MS 176 55v: 6.4.1951

Page Break 100

A Poem†a

Page 100

If you throw the fragrant veil of
true love on my head,
at the moving of the hands
the soft stirring of the limbs
bereft of sense becomes the soul.

Page 100

Can you grasp it as it's drifting
as it stirs with scarce a sound
and deep within the heart its imprint fixes.

Page 100

At the sounding of the morning's bell
The gardener through the garden's space is passing
Touching with light feet his ground //the ground//
the flowers rouse themselves and gaze
inquiring on his radiant,
peaceful face:
Who was it then who wove the veil around your foot
touching us gently like a breath of wind
Is even Zephyr too your servant?
Was it the spider, or was it the silkworm?

Page Break 101

Notes

Page 101

†1 The Lieutenant in question is most probably Vojeslav Molé.

Page 101

†2 Arvid Sjögren, a friend and relation of Ludwig Wittgenstein, married to his niece Clara Salzer.

Page 101

†3 Ernest Renan: *History of the people of Israel, Vol 1, Chapter III.*

Page 101

†4 An earlier draft of the printed foreword to *Philosophical Remarks*, edited by Rush Rhees and translated by Raymond Hargreaves and Roger White (Oxford, Blackwell 1975).

Page 101

†5 G.E. Lessing, *The Education of the Human Race*, §§48-49.

Page 101

†6 Not clearly legible, unclear whether: "types of human being." or "human beings. types." and "types." as a variant on "Human beings."

Page 101

†7 The editor has corrected an obvious slip in the punctuation of the original, which results in nonsense.

Page 101

†8 Wittgenstein first wrote "Frege, Russell, Spengler, Sraffa" and added the other names later without adding the necessary commas.

Page 101

†9 The sentence is from Wilhelm Busch's prose poem "Edward's dream", The editor is indebted to MR. Robert Löffler for this information.

Page 101

†10 In the original "are": Wittgenstein first wrote "the Jews", and then replaced it with "the history of the Jews", without correcting the "are" to "is".

Page 101

†11 The time signature is not in the MS. The editor is very grateful to Mr Fabian Dahlström for professional help in interpreting the notes, which are very hard to read. Mr Dahlström has suggested the following interpretation:

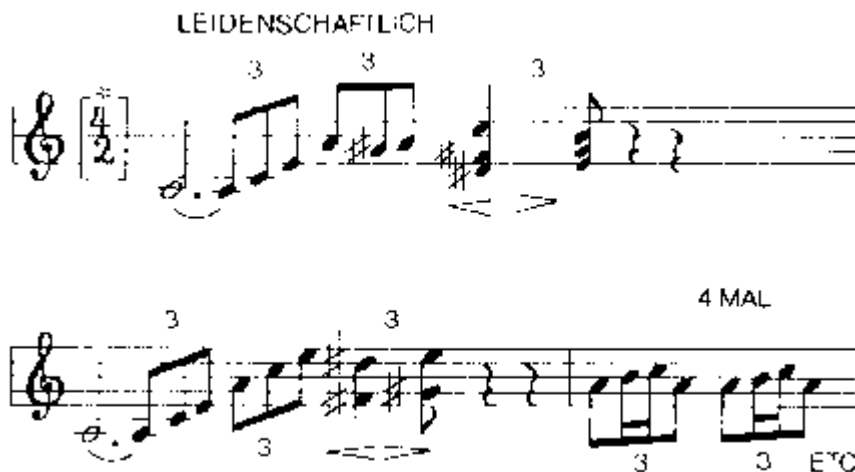

Page Break 102

Page 102

†12 Not clearly legible. Unclear whether it reads: "if its wearer looks smugly at himself in it in the mirror" or "if its wearer smugly smartens himself up in it in the mirror".

Page 102

†13 Adelbert von Chamisso, *The Strange Tale of Peter Schlemihl.*

Page 102

†14 Heinrich von Kleist: "Letter from One poet to Another", 5th January 1811.

Page 102

†15 The words "no" in "<no> western occupation" and "language" in "the words of our <language>" were supplied from the corresponding text of the notebook in MS 153a: S. 122r.

Page 102

†16 Not clearly legible: comma after "enclose".

Page 102

†17 Cf. *Philosophical Investigations*, Part I, § 131.

Page 102

†18 It is unclear whether the text reads: "Nur so nämlich können wir unsere <n> Behauptungen der Ungerechtigkeit (..) entgehen" or whether "unsere Behauptungen" ("our claims") is a variant for "wir" ("we").

"unsere Behauptungen" was inserted between "wir" und "der Ungerechtigkeit" ("prejudice").

Page 102

†19 Not clearly legible: either "for" or "then".

Page 102

†20 Not clearly legible. "Maßeinheit--" Wittgenstein seems first to have written "Ein guter Maßstab" ("a good measuring rod"), then, changing the gender of the indefinite article appropriately, to have changed "Maßstab" to "Maßeinheit" ("unit of measurement"). The gender of "guter" (good) was not changed.

Page 102

†21 It is unclear whether the text reads "diese" ("this" in its feminine form which would make it refer to "plausibility") or "dieser" ("this" in its masculine form which would make it refer to "narrative").

Page 102

†22 In the text there is an intrusive comma which makes no grammatical sense and is clearly an error.

Page 102

†23 Anna Rebni, schoolteacher from Skjolden, Norway, where Wittgenstein had a hut.

Page 102

†24 Schopenhauer, "The Metaphysics of Music", *The World as Will and as Idea*, Chapter 39.

Page 102

†25 Wittgenstein's sister, Margarete Stonborough, for whom he built the house at 19 Kundmannngasse, Vienna.

Page 102

†26 It is unclear in the text whether this should read "private performances" ("Leeraufführungen"--literally empty performances) or "training performances" ("Lehraufführungen").

Page 102

†27 Wittgenstein expressly notes above "not-admired": "hyphen".

Page 102

†28 The sense of "(N.)" and "(W.)" is unclear.

Page 102

†29 A department store in London.

Page 102

†30 "scientists are not (...) on their laurels" is crossed out, which shows that Wittgenstein preferred the two subsequent alternatives.

Page 102

†31 Cf. Editor's note on p. 302 of *Remarks on the Foundations of Mathematics*, Second Edition.

Page 102

†32 Cf. *Philosophical Investigations*, Part I, § 546.

Page 102

†33 The German text is unclear as between "an" and "aus". [These involve a slight difference in emphasis: perhaps roughly, between "to find the rest of the way home from here" and "to find the rest of the way home from here onwards". But the difference, such as it is, can hardly be reproduced in English. (PW)]

Page 102

†34 Gottfried Keller, *The Lost Laugh*.

Page Break 103

Page 103

†35 Goethe, *The Bride of Corinth*.

Page 103

†36 *Philosophical Investigations*, Part II, Section IV.

Page 103

†37 Cf. *Zettel* § 175.

Page 103

†38 Text unclear: *either* Section mark "S", "Oh es kann ein Schlüssel (...)" ["Oh a key can (...)] *or* "Soh es kann ein Schlüssel (...)"--with the "h" in "Soh" crossed out ["So a key can (...)].

Page 103

†39 Not clearly legible: either "etwas" ("something") or "etwa" ("perhaps").

Page 103

†40 Friedrich Nietzsche, *Human, All-Too Human*, I, § 155.

Page 103

†41 "Urwerk". It is unclear whether this should read "Uhrwerk" [= "original work" or perhaps even "prototype"] or "Uhrwerk" ["clockwork" or simply "piece of machinery"].

Page 103

†42 During the Second World War and immediately after.

Page 103

†43 Not clearly legible: either "nach" (= "after") or noch (= "yet or "still").

Page 103

†44 In the original: "Strike": unclear whether English "strike" or German "Streike" (= "strikes").

Page 103

†45 In the original "anchor" in "rescue-anchor" is crossed out; "the rescue-anchor" was replaced by the variant "the <rescue>-instrument". However in what follows ("rush up to it & seize it") the masculine pronoun "ihn" (corresponding to "anchor" is not replaced by the neuter pronoun "es" (corresponding to "instrument").

Page 103

†46 Georg Christoph Lichtenberg, *Timorus*, Perface[[sic]]. The complete sentence reads: "For the ox & the ass can do things too, but up to now only a human being can give you an assurance."

Page 103

†47 Letter to Goethe, 17th December 1795

Page 103

†48 For *Philosophical Investigations*.

Page 103

†49 Not clearly legible: whether singular or plural.

Page 103

†50 St. John of the Cross, Juan de Yepes, 1542-91.

Page 103

†51 Cf. *Notebooks*, 7.10.1916.

Page 103

†52 Beethoven's 8th Symphony.

Page 103

†53 John Bunyan, *The Pilgrim's Progress from this World to that which is to come*.

Page 103

†54 It may be that the upper case "Einer" ("someone") is connected with the personal pronoun "er" ("he") and the lower case "einer" ("one") with the impersonal "man" ("one").

Page 103

†55 Cf. *Zettel*, § 712.

Page Break 104

Page Break 105

Appendix

Page Break 106

Page Break 107

List of Sources

(The remarks that in this edition have been completed to comprise a whole section are marked with an asterisk [*].)

MS 101 7 c	:	21.8.1914*
MS 106 58	:	1929
MS 106 247	:	1929
MS 105 46 c	:	1929*
MS 105 67 c	:	1929
MS 105 73 c	:	1929
MS 105 85 c	:	1929
MS 107 70 c	:	1929
MS 107 72 c	:	1929*
MS 107 82	:	1929
MS 107 82 c	:	1929

MS 107 97 c : 1929
MS 107 98 c : 1929
MS 107 100 c : 1929
MS 107 116 c : 1929
MS 107 120 c : 1929
MS 107 130 c : 1929
MS 107 156 c : 10.10.1929
MS 107 176 c : 24.10.1929
MS 107 184 c : 7.11.1929
MS 107 192 c : 10.11.1929
MS 107 196 : 15.11.1929
MS 107 229 : 10.-11.1.1930
MS 107 242 : 16.1.1930
MS 108 207 : 29.6.1930
MS 109 28 : 22.8.1930
MS 109 200 : 5.11.1930
MS 109 204 : 6.-7.11.1930
MS 109 212 : 8.11.1930
MS 110 5 : 12.12.1930
MS 110 10 : 13.12.1930
MS 110 11 : 25.12.1930
MS 110 12 : 12.-16.1.1931
MS 110 18 : 18.1.1931
MS 110 61 : 10.2.1931
MS 110 67 : 12.2.1931
MS 153a 4v : 10.5.1931
MS 153a 12v : 1931
MS 153a 18v : 1931
MS 153a 29v : 1931
MS 153a 35r : 1931
MS 153a 35v : 1931
MS 153a 90v : 1931
MS 153a 127v : 1931
MS 153a 128v : 1931
MS 153a 136r : 1931
MS 153a 141r : 1931
MS 153a 160v : 1931
MS 153b 3r : 1931
MS 153b 29r : 1931
MS 153b 39v : 1931
MS 154 1r : 1931
MS 154 1v : 1931
MS 154 15v : 1931
MS 154 20v : 1931
MS 154 21v : 1931
MS 154 25v : 1931
MS 155 29r : 1931
MS 155 46r : 1931
MS 110 200 : 22.6.1931
MS 110 226 : 25.6.1931
MS 110 231 c : 29.6.1931
MS 110 238 : 30.6.1931
MS 110 257 : 2.7.1931

Page Break 108

MS 110 260 c : 2.7.1931
MS 111 2c : 7.7.1931

MS 111 55 : 30.7.1931
MS 111 77 : 11.8.1931
MS 111 115 : 19.8.1931
MS 111 119 : 19.8.1931
MS 111 132 : 23.8.1931
MS 111 133 : 24.8.1931
MS 111 173 : 13.9.1931
MS 111 180 : 13.9.1931
MS 111 194 : 13.9.1931
MS 111 195 : 13.9.1931
MS 112 1 : 5.10.1931
MS 112 46 : 14.10.1931
MS 112 60 : 15.10.1931
MS 112 76 : 24.10.1931
MS 112 114 : 27.10.1931
MS 112 139 : 1.11.1931
MS 112 153 : 11.11.1931
MS 112 221 : 22.11.1931
MS 112 223 : 22.11.1931
MS 112 225 : 22.11.1931
MS 112 231 : 22.11.1931
MS 112 232 : 22.11.1931
MS 112 233 : 22.11.1931
MS 112 255 : 26.11.1931
MS 113 80 : 29.2.1932
MS 156a 25r : ca. 1932-1934
MS 156a 30v : ca. 1932-1934
MS 156a 49r : ca. 1932-1934
MS 156a 49v : ca. 1932-1934
MS 156a 57r : ca. 1932-1934
MS 156a 58v : ca. 1932-1934
MS 156b 14v : ca. 1932-1934
MS 156b 23v : ca. 1932-1934
MS 156b 24v : ca. 1932-1934
MS 156b 32r : ca. 1932-1934
MS 145 14r : Herbst 1933*
MS 145 17v : 1933
MS 146 25v : 1933-1934
MS 146 35v : 1933-1934
MS 146 44v : 1933-1934
MS 147 16r : 1934
MS 147 22r : 1934
MS 157a 2r : 1934*
MS 157a 22v : 1934
MS 157a 44v : 1934 oder 1937
MS 116 56 : 1937
MS 157a 57r : 1937
MS 157a 57r : 1937
MS 157a 58r : 1937
MS 157a 62v : 1937
MS 157a 66v c:1937
MS 157a 67v c:1937
MS 157b 9v : 1937
MS 157b 15v : 1937
MS 118 17r c : 27.8.1937*
MS 118 20r : 27.8.1937
MS 118 21v : 27.8.1937

MS 118 35r c : 29.8.1937
MS 118 45r c : 1.9.1937
MS 118 56r c : 4.9.1937*
MS 118 71v c : 9.9.1937
MS 118 86v : 11.9.1937
MS 118 87r c : 11.9.1937*
MS 118 94v : 15.9.1937
MS 118 113r : 24.9.1937
MS 118 117v : 24.9.1937
MS 119 59 : 1.10.1937
MS 119 71 : 4.10.1937
MS 119 83 : 7.10.1937
MS 119 108 : 14.10.1937
MS 119 146 : 21.10.1937
MS 119 151 : 22.10.1937
MS 120 8 : 20.11.1937
MS 120 83 c : 8.-9.12.1937*
MS 120 103 c : 12.12.1937
MS 120 108 c : 12.12.1937*

Page Break 109

MS 120 113 : 2.1.1938
MS 120 142 : 19.2.1938
MS 120 283 : 7.4.1938
MS 120 289 : 20.4.1938
MS 121 26v : 25.5.1938
MS 121 35v : 11.6.1938
MS 122 129 : 30.12.1939
MS 162a 18 : 1939-1940
MS 162b 16v : 1939-1940
MS 162b 21v : 1939-1940
MS 162b 22r c : 1939-1940
MS 162b 24r : 1939-1940
MS 162b 37r c : 1939-1940
MS 162b 42v c : 1939-1940
MS 162b 53r : 1939-1940
MS 162b 55v : 1939-1940
MS 162b 59r : 1939-1940*
MS 162b 59v : 1939-1940
MS 162b 61r : 1939-1940
MS 162b 63r : 1939-1940
MS 122 175 c : 10.1.1940
MS 122 190 c : 13.1.1940
MS 122 235 : 1.2.1940
MS 117 151 c : 4.2.1940
MS 117 152 c : 4.2.1940
MS 117 153 c : 4.2.1940
MS 117 156 : 5.2.1940
MS 117 160 c : 10.2.1940
MS 117 168 c : 17.2.1940
MS 117 225 : 2.3.1940
MS 117 237 : 6.3.1940
MS 117 253 : 11.3.1940
MS 162b 67r : 2.7.1940
MS 162b 68v : 14.8.1940
MS 162b 69v : 19.8.1940
MS 162b 70r : 21.8.1940

MS 123 112 : 1.6.1941
MS 124 3 c : 6.6.1941
MS 124 25 :11.6.1941
MS 124 30 :11.6.1941
MS 124 31 : 12.6.1941
MS 124 49 : 16.6.1941
MS 124 56 : 18.6.1941
MS 124 82 : 27.6.1941
MS 124 93 : 3.7.1941
MS 163 25r : 4.7.1941
MS 163 34r : 7.7.1941
MS 163 39r c : 8.7.1941
MS 163 47v : 11.7.1941
MS 163 64v c : 6.9.1941
MS 125 2v : 4.1.1942 oder später
MS 125 21r : 1942
MS 125 42r : 1942
MS 125 44r : 1942
MS 125 58r : 1942
MS 125 58v : 18.5.1942
MS 126 15r : 28.10.1942
MS 126 64r : 15.12.1942
MS 126 65v : 17.12.1942
MS 127 14r : 20.1.1943
MS 127 35v : 4.4.1943
MS 127 36v : 27.2.1944
MS 127 41v : 4.3.1944
MS 127 76r : 1944
MS 127 77v : 1944
MS 127 78v : 1944
MS 127 84r : 1944
MS 129 181 : 1944 oder später
MS 165 200 c : ca. 1941-1944
MS 165 204 : ca. 1944
MS 128 46 : ca. 1944
MS 128 49 : ca. 1944
MS 179 20 : ca. 1945
MS 179 26 : ca. 1945
MS 179 27 : ca. 1945
MS 180a 30 : ca. 1945

Page Break 110

MS 180a 67 : ca. 1945
MS 130 239 : 1.8.1946
MS 130 283 : 5.8.1946
MS 130 291c : 9.8.1946
MS 131 2 : 10.8.1946
MS 131 19 : 11.8.1946
MS 131 27 : 12.8.1946
MS 131 38 : 14.8.1946
MS 131 43 : 14.8.1946*
MS 131 46 : 15.8.1946
MS 131 48 : 15.8.1946
MS 131 66 c : 19.8.1946
MS 131 79 c : 20.8.1946
MS 131 80 : 20.8.1946
MS 131 163 : 31.8.1946

MS 131 176 : 1.9.1946
MS 131 180 : 2.9.1946
MS 131 182 : 2.9.1946
MS 131 186 : 3.9.1946
MS 131 218 : 8.9.1946
MS 131 219 : 8.9.1946
MS 131 221 : 8.9.1946
MS 132 8 : 11.9.1946
MS 132 12 : 12.9.1946
MS 132 46 c : 22.9.1946
MS 132 51 : 22.9.1946
MS 132 59 : 25.9.1946
MS 132 62 : 25.9.1946*
MS 132 69 : 26.9.1946
MS 132 75 : 28.9.1946*
MS 132 136 : 7.10.1946
MS 132 145 : 8.10.1946
MS 132 167 : 11.10.1946
MS 132 190 : 16.10.1946
MS 132 191 : 18.10.1946
MS 132 197 : 19.10.1946
MS 132 202 : 20.10.1946
MS 132 205 : 22.10.1946
MS 133 2 : 23.10.1946
MS 133 6 : 24.10.1946
MS 133 12 : :24.10.1946
MS 133 18 : :29.10.1946
MS 133 21 : :31.10.1946
MS 133 30 : :1.-2.11.1946
MS 133 68 c : 12.11.1946*
MS 133 82 : 24.11.1946
MS 133 82 : 24.11.1946
MS 133 90 : 7.1.1947
MS 133 118 : 19.1.1947
MS 133 188 : 27.2.1947*
MS 134 9 : 3.3.1947
MS 134 20 : 5.3.1947
MS 134 27 : 10.-15.3.1947*
MS 134 76 : 28.3.1947
MS 134 78 : 30.3.1947
MS 134 80 : 30.3.1947
MS 134 89 : 2.4.1947
MS 134 95 : 3.4.1947
MS 134 100 : 4.4.1947
MS 134 105 : 5.4.1947
MS 134 106 : 5.4.1947
MS 134 108 : 5.4.1947
MS 134 120 : 7.4.1947
MS 134 124 : 8.4.1947
MS 134 129 : 9.4.1947
MS 134 133 : 10.4.1947
MS 134 141 : 13.4.1947
MS 134 143 : 13.-14.4.1947*
MS 134 156 : 11.5.1947
MS 134 157 : 11.5.1947
MS 134 180 : 27.6.1947
MS 134 181 : 27.6.1947

MS 135 14 : 14.7.1947
MS 135 23 : 16.7.1947
MS 135 85 : 24.7.1947
MS 135 101 : 26.7.1947
MS 135 102 : 27.7.1947
MS 135 103 c : 27.7.1947

Page Break 111

MS 135 110 : 28.7.1947
MS 135 133 : 2.8.1947
MS 135 191 : 17.12.1947
MS 135 192 : 17.12.1947
MS 136 16b : 21.12.1947
MS 136 18b : 21.12.1947
MS 136 31a : 24.12.1947
MS 136 37a : 25.12.1947
MS 167 10v : ca. 1947-1948
MS 136 51a : 3.1.1948
MS 136 59a : 4.1.1948
MS 136 60b : 4.1.1948
MS 136 62a : 4.1.1948
MS 136 80a : 8.1.1948
MS 136 81a : 8.1.1948
MS 136 81b : 8.1.1948
MS 136 89a : 10.1.1948
MS 136 91b : 11.1.1948
MS 136 92b : 11.1.1948
MS 136 107a : 14.1.1948
MS 136 110b : 14.1.1948*
MS 136 113a : 15.1.1948
MS 136 117a : 15.1.1948
MS 136 128b : 18.1.1948
MS 136 129b : 19.1.1948
MS 136 137a : 22.1.1948
MS 137 17a : 10.2.1948
MS 137 20b : 15.2.1948
MS 137 30b : 8.3.1948
MS 137 34b : 10.3.1948
MS 137 40b : 28.5.1948
MS 137 42a : 30.5.1948
MS 137 43a : 30.5.1948
MS 137 48b : 4.6.1948
MS 137 49a : 4.6.1948
MS 137 49b : 4.6.1948
MS 137 51a : 15.6.1948
MS 137 54b : 25.6.1948
MS 137 57a : 26.6.1948
MS 137 57b : 30.6.1948
MS 137 65b : 3.7.1948
MS 137 67a : 3.7.1948
MS 137 67a : 4.7.1948
MS 137 67b : 5.7.1948
MS 137 70b : 7.7.1948
MS 137 71a : 9.7.1948
MS 137 72b : 14.7.1948
MS 137 73b : 25.7.1948
MS 137 75b : 23.8.1948

MS 137 76a : 19.10.1948
MS 137 78b : 24.10.1948
MS 137 81b : 27.10.1948
MS 137 88a : 4.11.1948
MS 137 88b : 4.11.1948
MS 137 89b : 5.11.1948
MS 137 97b : 14.11.1948
MS 137 97b : 16.11.1948
MS 137 100a : 19.11.1948
MS 137 102a : 20.11.1948
MS 137 104a : 21.11.1948
MS 137 104b : 22.11.1948
MS 137 106b : 23.11.1948
MS 137 111b : 28.11.1948
MS 137 112b : 29.11.1948
MS 137 120a : 10.12.1948
MS 137 122a : 11.12.1948
MS 137 127a : 16.12.1948
MS 137 130a : 22.12.1948
MS 137 134b : 25.12.1948
MS 137 134b : 26.12.1948
MS 137 135a c:27.12.1948
MS 137 135a : 28.12.1948
MS 137 136b : 31.12.1948
MS 168 lr : Jänner 1949
MS 169 58v : 1949
MS 169 62v : 1949
MS 137 137a : 1.1.1949
MS 137 140a : 4.1.1949

Page Break 112

MS 137 141a : 6.1.1949
MS 137 143a : 7.-8.1.1949
MS 138 2a : 17.1.1949
MS 138 3a : 18.1.1949
MS 138 4a : 18.1.1949
MS 138 4b : 19.1.1949
MS 138 5b : 21.1.1949
MS 138 8a : 22.1.1949
MS 138 8b : 23.1.1949
MS 138 9a : 24.1.1949
MS 138 9a : 24.1.1949
MS 138 9b : 25.1.1949
MS 138 11a : 28.1.1949
MS 138 12a : 30.1.1949
MS 138 13b : 2.2.1949
MS 138 14a : 2.2.1949
MS 138 25a : 22.2.1949
MS 138 28a : 27.2.1949
MS 138 28b : 27.2.1949
MS 138 29a : 1.3.1949
MS 138 30b : 17.3.1949
MS 138 32b : 20.5.1949
MS 138 32b : 20.5.1949
MS 173 17r : 30.3.1950
MS 173 35r : 12.4.1950 oder später
MS 173 69r : 1950

MS 173 75v : 1950
MS 173 92r : 1950
MS 174 1v : 1950
MS 174 5r : 24.4.1950 oder später
MS 174 5v : 1950
MS 174 7v : 1950
MS 174 8r : 1950
MS 174 10r : 1950
MS 175 56r : 15.3.1951
MS 175 63v : 17.3.1951
MS 176 55v : 16.4.1951

Page Break 113

List of Sources, Arranged Alphanumerically

(The remarks that in this edition have been completed to comprise a whole section are marked with an asterisk [*].)

MS 101 7 c : 21.8.1914*
MS 105 46 c : 1929*
MS 105 67 c : 1929
MS 105 73 c : 1929
MS 105 85 c : 1929
MS 106 247 : 1929
MS 106 58 : 1929
MS 107 100 c : 1929
MS 107 116 c : 1929
MS 107 120 c : 1929
MS 107 130 c : 1929
MS 107 156 c : 10.10.1929
MS 107 176 c : 24.10.1929
MS 107 184 c : 7.11.1929
MS 107 192 c : 10.11.1929
MS 107 196 : 15.11.1929
MS 107 229 : 10.-11.1.1930
MS 107 242 : 16.1.1930
MS 107 70 c : 1929
MS 107 72 c : 1929*
MS 107 82 : 1929
MS 107 82 c : 1929
MS 107 97 c : 1929
MS 107 98 c : 1929
MS 108 207 : 29.6.1930
MS 109 200 : 5.11.1930
MS 109 204 : 6.-7.11.1930
MS 109 212 : 8.11.1930
MS 109 28 : 22.8.1930
MS 110 10 : 13.12.1930
MS 110 11 : 25.12.1930
MS 110 12 : 12.-16.1.1931
MS 110 18 : 18.1.1931
MS 110 200 : 22.6.1931
MS 110 226 : 25.6.1931
MS 110 231 c : 29.6.1931
MS 110 238 : 30.6.1931
MS 110 257 : 2.7.1931
MS 110 260 c : 2.7.1931

MS 110 5 : 12.12.1930
MS 110 61 : 10.2.1931
MS 110 67 : 12.2.1931
MS 111 115 : 19.8.1931
MS 111 119 : 19.8.1931
MS 111 132 : 23.8.1931
MS 111 133 : 24.8.1931
MS 111 173 : 13.9.1931
MS 111 180 : 13.9.1931
MS 111 194 : 13.9.1931
MS 111 195 : 13.9.1931
MS 111 2 c : 7.7.1931
MS 111 55 : 30.7.1931
MS 111 77 : 11.8.1931
MS 112 1 : 5.10.1931
MS 112 114 : 27.10.1931
MS 112 139 : 1.11.1931
MS 112 153 : 11.11.1931
MS 112 221 : 22.11.1931
MS 112 223 : 22.11.1931
MS 112 225 : 22.11.1931
MS 112 231 : 22.11.1931
MS 112 232 : 22.11.1931
MS 112 233 : 22.11.1931
MS 112 255 : 26.11.1931

Page Break 114

MS 112 46 : 14.10.1931
MS 112 60 : 15.10.1931
MS 112 76 : 24.10.1931
MS 113 80 : 29.2.1932
MS 116 56 : 1937
MS 117 151 c : 4.2.1940
MS 117 152 c : 4.2.1940
MS 117 153 c : 4.2.1940
MS 117 156 : 5.2.1940
MS 117 160 c : 10.2.1940
MS 117 168 c : 17.2.1940
MS 117 225 : 2.3.1940
MS 117 237 : 6.3.1940
MS 117 253 : 11.3.1940
MS 118 113r : 24.9.1937
MS 118 117v : 24.9.1937
MS 118 17r c : 27.8.1937*
MS 118 20r : 27.8.1937
MS 118 21v : 27.8.1937
MS 118 35r c : 29.8.1937
MS 118 45r c : 1.9.1937
MS 118 56r c : 4.9.1937*
MS 118 71v c : 9.9.1937
MS 118 86v : 11.9.1937
MS 118 87r c : 11.9.1937*
MS 118 94v : 15.9.1937
MS 119 108 : 14.10.1937
MS 119 146 : 21.10.1937
MS 119 151 : 22.10.1937
MS 119 59 : 1.10.1937

MS 119 71 : 4.10.1937
MS 119 83 : 7.10.1937
MS 120 103 c : 12.12.1937
MS 120 108 c : 12.12.1937*
MS 120 113 : 2.1.1938
MS 120 142 : 19.2.1938
MS 120 283 : 7.4.1938
MS 120 289 : 20.4.1938
MS 120 8 : 20.11.1937
MS 120 83 c : 8.-9.12.1937*
MS 121 26v : 25.5.1938
MS 121 35v : 11.6.1938
MS 122 129 : 30.12.1939
MS 122 175c : 10.1.1940
MS 122 190 c : 13.1.1940
MS 122 235 : 1.2.1940
MS 123 112 : 1.6.1941
MS 124 25 : 11.6.1941
MS 124 3 c : 6.6.1941
MS 124 30 : 11.6.1941
MS 124 31 : 12.6.1941
MS 124 49 : 16.6.1941
MS 124 56 : 18.6.1941
MS 124 82 : 27.6.1941
MS 124 93 : 3.7.1941
MS 125 21r : 1942
MS 125 2v : 4.1.1942 oder später
MS 125 42r : 1942
MS 125 44r : 1942
MS 125 58r : 1942
MS 125 58v : 18.5.1942
MS 126 15r : 28.10.1942
MS 126 64r : 15.12.1942
MS 126 65v : 17.12.1942
MS 127 14r : 20.1.1943
MS 127 35v : 4.4.1943
MS 127 36v : 27.2.1944
MS 127 41v : 4.3.1944
MS 127 76r : 1944
MS 127 77v : 1944
MS 127 78v : 1944
MS 127 84r : 1944
MS 128 46 : ca. 1944
MS 128 49 : ca. 1944
MS 129 181 : 1944 oder später
MS 130 239 : 1.8.1946

Page Break 115

MS 130 283 : 5.8.1946
MS 130 291 c : 9.8.1946
MS 131 163 : 31.8.1946
MS 131 176 : 1.9.1946
MS 131 180 : 2.9.1946
MS 131 182 : 2.9.1946
MS 131 186 : 3.9.1946
MS 131 19 : 11.8.1946
MS 131 2 : 10.8.1946

MS 131 218	:	8.9.1946
MS 131 219	:	8.9.1946
MS 131 221	:	8.9.1946
MS 131 27	:	12.8.1946
MS 131 38	:	14.8.1946
MS 131 43	:	14.8.1946*
MS 131 46	:	15.8.1946
MS 131 48	:	15.8.1946
MS 131 66 c	:	19.8.1946
MS 131 79 c	:	20.8.1946
MS 131 80	:	19.8.1946
MS 132 12	:	12.9.1946
MS 132 136	:	7.10.1946
MS 132 145	:	8.10.1946
MS 132 167	:	11.10.1946
MS 132 190	:	16.10.1946
MS 132 191	:	18.10.1946
MS 132 197	:	19.10.1946
MS 132 202	:	20.10.1946
MS 132 205	:	22.10.1946
MS 132 46 c	:	22.9.1946
MS 132 51	:	22.9.1946
MS 132 59	:	25.9.1946
MS 132 62	:	25.9.1946*
MS 132 69	:	26.9.1946
MS 132 75	:	28.9.1946*
MS 132 8	:	11.9.1946
MS 133 118	:	19.1.1947
MS 133 12	:	24.10.1946
MS 133 18	:	29.10.1946
MS 133 188	:	27.2.1947*
MS 133 2	:	23.10.1946
MS 133 21	:	31.10.1946
MS 133 30	:	1.-2.11.1946
MS 133 6	:	24.10.1946
MS 133 68 c	:	12.11.1946*
MS 133 82	:	24.11.1946
MS 133 82	:	24.11.1946
MS 133 90	:	7.1.1947
MS 134 100	:	4.4.1947
MS 134 105	:	5.4.1947
MS 134 106	:	5.4.1947
MS 134 108	:	5.4.1947
MS 134 120	:	7.4.1947
MS 134 124	:	8.4.1947
MS 134 129	:	9.4.1947
MS 134 133	:	10.4.1947
MS 134 141	:	13.4.1947
MS 134 143	:	13.-14.4.1947*
MS 134 156	:	11.5.1947
MS 134 157	:	11.5.1947
MS 134 180	:	27.6.1947
MS 134 181	:	27.6.1947
MS 134 20	:	5.3.1947
MS 134 27	:	10.-15.3.1947*
MS 134 76	:	28.3.1947
MS 134 78	:	30.3.1947

MS 134 80 : 30.3.1947
MS 134 89 : 2.4.1947
MS 134 9 : 3.3.1947
MS 134 95 : 3.4.1947
MS 135 101 : 26.7.1947
MS 135 102 : 27.7.1947
MS 135 103 c : 27.7.1947
MS 135 110 : 28.7.1947
MS 135 133 : 2.8.1947
MS 135 14 : 14.7.1947
MS 135 191 : 17.12.1947
MS 135 192 : 17.12.1947

Page Break 116

MS 135 23 : 16.7.1947
MS 135 85 : 24.7.1947
MS 136 107a : 14.1.1948
MS 136 110b : 14.1.1948*
MS 136 113a : 15.1.1948
MS 136 117a : 15.1.1948
MS 136 128b : 18.1.1948
MS 136 129b : 19.1.1948
MS 136 137a : 22.1.1948
MS 136 16b : 21.12.1947
MS 136 18b : 21.12.1947
MS 136 31a : 24.12.1947
MS 136 37a : 25.12.1947
MS 136 51a : 3.1.1948
MS 136 59a : 4.1.1948
MS 136 60b : 4.1.1948
MS 136 62a : 4.1.1948
MS 136 80a : 8.1.1948
MS 136 81a : 8.1.1948
MS 136 81b : 8.1.1948
MS 136 89a : 10.1.1948
MS 136 91b : 11.1.1948
MS 136 92b : 11.1.1948
MS 137 100a : 19.11.1948
MS 137 102a : 20.11.1948
MS 137 104a : 21.11.1948
MS 137 104b : 22.11.1948
MS 137 106b : 23.11.1948
MS 137 111b : 28.11.1948
MS 137 112b : 29.11.1948
MS 137 120a : 10.12.1948
MS 137 122a : 11.12.1948
MS 137 127a : 16.12.1948
MS 137 130a : 22.12.1948
MS 137 134b : 25.12.1948
MS 137 134b : 26.12.1948
MS 137 135a c: 28.12.1948
MS 137 135a c: 27.12.1948
MS 137 136b : 31.12.1948
MS 137 137a : 1.1.1949
MS 137 140a : 4.1.1949
MS 137 141a : 6.1.1949
MS 137 143a : 7.-8.1.1949

MS 137 17a : 10.2.1948
MS 137 20b : 15.2.1948
MS 137 30b : 8.3.1948
MS 137 34b : 10.3.1948
MS 137 40b : 28.5.1948
MS 137 42a : 30.5.1948
MS 137 43a : 30.5.1948
MS 137 48b : 4.6.1948
MS 137 49a : 4.6.1948
MS 137 49b : 4.6.1948
MS 137 51a : 15.6.1948
MS 137 54b : 25.6.1948
MS 137 57a : 26.6.1948
MS 137 57b : 30.6.1948
MS 137 65b : 3.7.1948
MS 137 67a : 3.7.1948
MS 137 67a : 4.7.1948
MS 137 67b : 5.7.1948
MS 137 70b : 7.7.1948
MS 137 71a : 9.7.1948
MS 137 72b : 14.7.1948
MS 137 73b : 25.7.1948
MS 137 75b : 23.8.1948
MS 137 76a : 19.10.1948
MS 137 78b : 24.10.1948
MS 137 81b : 27.10.1948
MS 137 88a : 4.11.1948
MS 137 88b : 4.11.1948
MS 137 89b : 5.11.1948
MS 137 97b : 14.11.1948
MS 137 97b : 16.11.1948
MS 138 11a : 28.1.1949
MS 138 12a : 30.1.1949
MS 138 13b : 2.2.1949
MS 138 14a : 2.2.1949

Page Break 117

MS 138 25a : 22.2.1949
MS 138 28a : 27.2.1949
MS 138 28b : 27.2.1949
MS 138 29a : 1.3.1949
MS 138 2a : 17.1.1949
MS 138 30b : 17.3.1949
MS 138 32b : 20.5.1949
MS 138 32b : 20.5.1949
MS 138 3a : 18.1.1949
MS 138 4a : 18.1.1949
MS 138 4b : 19.1.1949
MS 138 5b : 21.1.1949
MS 138 8a : 22.1.1949
MS 138 8b : 23.1.1949
MS 138 9a : 24.1.1949
MS 138 9a : 24.1.1949
MS 138 9b : 25.1.1949
MS 145 14r : Herbst 1933*
MS 145 17v : 1933
MS 146 25v : 1933-1934

MS 146 35v	:	1933-1934
MS 146 44v	:	1933-1934
MS 147 16r	:	1934
MS 147 22r	:	1934
MS 153a 127v	:	1931
MS 153a 128v	:	1931
MS 153 12v	:	1931
MS 153a 136r	:	1931
MS 153a 141r	:	1931
MS 153a 160v	:	1931
MS 153a 18v	:	1931
MS 153a 29v	:	1931
MS 153a 35r	:	1931
MS 153a 35v	:	1931
MS 153a 4v	:	10.5.1931
MS 153b 90v	:	1931
MS 153 29r	:	1931
MS 153b 39v	:	1931
MS 153b 3r	:	1931
MS 154 15v	:	1931
MS 154 1r	:	1931
MS 154 1v	:	1931
MS 154 20v	:	1931
MS 154 21v	:	1931
MS 154 25v	:	1931
MS 155 29r	:	1931
MS 155 46r	:	1931
MS 156a 25r	:	ca. 1932-1934
MS 156a 30v	:	ca. 1932-1934
MS 156a 49r	:	ca. 1932-1934
MS 156a 49v	:	ca. 1932-1934
MS 156a 57r	:	ca. 1932-1934
MS 156a 58b	:	ca. 1932-1934
MS 156b 14v	:	ca. 1932-1934
MS 156b 23v	:	ca. 1932-1934
MS 156b 24v	:	ca. 1932-1934
MS 156b 32r	:	ca. 1932-1934
MS 157a 22v	:	1934
MS 157a 2r	:	1934*
MS 157a 44v	:	1934 oder 1937
MS 157a 57r	:	1937
MS 157a 57r	:	1937
MS 157a 58r	:	1937
MS 157a 62v	:	1937
MS 157a 66v c:	:	1937
MS 157a 67v c:	:	1937
MS 157b 15v	:	1937
MS 157b 9v	:	1937
MS 162a 18	:	1939-1940
MS 162b 16v	:	1939-1940
MS 162b 21v	:	1939-1940
MS 162b 22r c:	:	1939-1940
MS 162b 24r	:	1939-1940
MS 162b 37r c:	:	1939-1940
MS 162b 42v c	:	1939-1940
MS 162b 53r	:	1939-1940
MS 162b 55v	:	1939-1940

Page Break 118

MS 162b 59r :	1939-1940*
MS 162b 59v :	1939-1940
MS 162b 61r :	1939-1940
MS 162b 63r :	1939-1940
MS 162b 67r :	2.7.1940
MS 162b 68v :	14.8.1940
MS 162b 69v :	19.8.1940
MS 162b 70r :	21.8.1940
MS 163 25r :	4.7.1941
MS 163 34r :	7.7.1941
MS 163 39r c :	8.7.1941
MS 163 47v :	11.7.1941
MS 163 64v c :	6.9.1941
MS 165 200 c :	ca. 1941-1944
MS 165 204 :	ca. 1944
MS 167 10v :	ca. 1947-1948
MS 168 1r :	Jänner 1949
MS 169 58v :	1949
MS 169 62v :	1949
MS 173 17r :	30.3.1950
MS 173 35r :	12.4.1950 oder später
MS 173 69r :	1950
MS 173 75v :	1950
MS 173 92r :	1950
MS 174 10r :	1950
MS 174 1v :	1950
MS 174 5r :	24.4.1950 oder später
MS 174 5v :	1950
MS 174 7v :	1950
MS 174 8r :	1950
MS 175 56r :	15.3.1951
MS 175 63v :	17.3.1951
MS 176 55v :	16.4.1951
MS 179 20 :	ca. 1945
MS 179 26 :	ca. 1945
MS 179 27 :	ca. 1945
MS 180a 30 :	ca. 1945
MS 180a 67 :	ca. 1945

Page Break 119

Page Break 120

Index of Beginnings of Remarks

(The remarks that in this edition have been completed to comprise a whole section are marked with an asterisk [*].)

Page 120

A beautiful garment that changes 19e

Page 120

A Bruckner symphony can be said 39e

Page 120

A confession has to be part 16e

Page 120

A cry of distress cannot be greater 52e

Page 120

Page 120	A curious analogy could be based	25e
Page 120	A foolish & naïve American film	65e
Page 120	A teacher who can show good, or	43e
Page 120	A good simile refreshes	3e
Page 120	A great architect in a bad period	84e
Page 120	A great blessing for me to be able	38e
Page 120	A hero looks death in the face,	58e
Page 120	At the time I modelled the head	16e
Page 120	A theme, no less than a face, wears	59e
Page 120	A thinker is very similar	14e
Page 120	A language, which is spoken in strict	85e
Page 120	A man sees well enough what he has,	56e
Page 120	A man's dreams are virtually never	64e
Page 120	A mediocre writer must beware of too	90e
Page 120	A miracle is, as it were, a	51e
Page 120	A new word is like a fresh seed	4e
Page 120	A picture of a complete apple tree,	17e
Page 120	A picture that is firmly rooted	95e
Page 120	At present we are combatting a trend	49e
Page 120	A proof of God ought really to be	97e
Page 120	A stylistic device may be useful	82e
Page 120	A tragedy might really always start	14e
Page 120	A writer far more talented than I	86e
Page 120	Almost in the same way as earlier	31e
Page 120	Almost the whole time I am writing	88e
Page 120	Always come down from the barren	86e
Page 120	Ambition is the death of thought	88e
Page 120	Amongst other things Christianity	61e
Page 120	And now we might say: There can be	94e

Page 120	And what I basically am after all	95e
Page 120	Animals come when their names	77e
Page 120	Anyone who is half-way decent will	51e
Page 120	Anyone who listens to a child's	4e
Page 120	Anything the reader can do	88e
Page Break 121		
Page 121	Anyway when I was in Norway	17e
Page 121	Appreciating music is a manifestation	80e
Page 121	Architecture glorifies something	74e
Page 121	Architecture immortalizes & glorifies	74e
Page 121	Architecture is a gesture	49e
Page 121	Are all people great human beings?	53e
Page 121	Are you a bad philosopher then,	87e
Page 121	As I again & again come across questions	76e
Page 121	As much (as) it has cost you, that	15e
Page 121	As we get old the problems slip	46e
Page 121	Bach said that everything he achieved	81e
Page 121	"Beethoven's great heart"--	96e
Page 121	Before there was an aeroplane	48e
Page 121	Being psychoanalyzed is in a way	40e
Page 121	'Believing' means, submitting to	52e
Page 121	Bruckner's Ninth is a sort of protest	39e
Page 121	But am I to say (if I reject images,	80e
Page 121	But I do not get to these problems	12e
Page 121	But isn't it a one-sided view of tragedy	14e
Page 121	But that does not mean that it is right	87e
Page 121	But then what is the relation between	31e
Page 121	By the way, in my artistic activities	29e

Page 121	By the way in the old conception	20e
Page 121	Can I say that drama has its own time	13e
Page 121	Caught a bit of a chill & unable to	32e
Page 121	Christian faith--so I believe--is	52e
Page 121	Christianity is not based on a historical	37e
Page 121	Colours are a stimulus to philosophizing	76e
Page 121	Compare the solution of philosophical	13e
Page 121	Composers' names. Sometimes it is the method	29e
Page 121	Concepts may alleviate mischief or	63e
Page 121	Conflict is dissipated in much	12e
Page 121	Conglomeration: national sentiment,	77e
Page 121	Could the concept of the punishments of hell	92e
Page 121	Counterpoint might represent an	46e
Page 121	Culture is an observance	89e
Page 121	Different 'interpretations' must correspond	46e
Page 121	Does the theme point to nothing beyond	59e
Page 121	Doing this work I am in the same state	36e
Page 121	Do not interest yourself in what	72e
Page 121	Don't apologize for anything, don't obscure	45e
Page 121	Don't demand too much, & don't be	46e
Page Break 122		
Page 122	Don't for heaven's sake, be afraid	64e
Page 122	Don't let yourself be guided by the example	47e
Page 122	Don't play with what lies deep	26e
Page 122	Each morning you have to break	4e
Page 122	Each sentence that I write	9e
Page 122	E.g. nothing more stupid than the chatter	71e
Page 122		

Election by grace: it is only permissible 34e
Page 122
Engelmann told me that when he rummages 6e
Page 122
Envy is something superficial-- 40e
Page 122
Esperanto. Our feeling of disgust, 60e
Page 122
Even if we are not thinking in circles, 91e
Page 122
Every artist has been influenced 27e
Page 122
"Fare well!" 60e
Page 122
Fate is the antithesis of natural law 70e
Page 122
For a human being the eternal, 92e
Page 122
For could one not equally say 94e
Page 122
[For the Foreword.] It is not 75e
Page 122
Freud's fanciful pseudo-explanations 62e
Page 122
Freud's idea: in madness the lock 39e
Page 122
Frida Schanz: 14e
Page 122
From Simplicissimus: riddles of 22e
Page 122
Genius is talent in which character 75e
Page 122
Genius is what makes us forget talent 49e
Page 122
Genius is what makes us forget the 49e
Page 122
Genius is what makes us unable to see 50e
Page 122
God grant the philosopher insight into 72e
Page 122
"God has commanded it, therefore we must 87e
Page 122
God may say to me: "I am judging you 99e
Page 122
God's essence is said to guarantee his 94e
Page 122
Go on, believe! It does no harm 52e
Page 122
Grasping the difficulty in its depth 55e
Page 122
Grillparzer: "How easy it is to move 15e
Page 122
(Had he not been caught in the machine 14e
Page 122

He has chosen them, in his goodness, 93e
Page 122
"He has commanded it" means here roughly:87e
Page 122
"He is experiencing the theme intensely 59e
Page 122
(Hence, I think, a great creator needs 68e
Page 122
"He refuses to..." means: it is in his 87e
Page 122
His talent too strikes me as 61e
Page 122
How are we taught the word "God" 94e
Page 122
How God judges people is something 98e

Page Break 123
Page 123
How hard it is for me to see what 44e
Page 123
How should we feel if we had never 15e
Page 123
How small a thought it takes 57e
Page 123
How then do we explain to someone 80e
Page 123
Human beings can regard all the evil 76e
Page 123
Human beings have a physical need 86e
Page 123
Humour is not a mood, but a way of 88e

Page 123
I am deeply suspicious of most of Shakespeare's 95e
Page 123
I am too soft, too weak, & so too lazy, 83e
Page 123
I am reading Lessing (on the Bible) 11e
Page 123
I am showing my pupils sections of 64e
Page 123
I am so afraid of someone's playing the piano 73e
Page 123
I ask countless irrelevant questions 77e
Page 123
I believe that what Goethe was really seeking26e
Page 123
I believe I summed up where I stand 28e
Page 123
I cannot judge whether I have only taste, 68e
Page 123
I cannot kneel to pray, because 63e
Page 123
I completely understand, how someone may hate 66e
Page 123
I could equally well have said: the distorted 63e
Page 123

I could imagine someone thinking the names 46e

Page 123

I could only stare in wonder at Shakespeare; 95e

Page 123

Ideas too sometimes fall from the tree 32e

Page 123

I do not think that Shakespeare 95e

Page 123

I do not think Shakespeare could have 96e

Page 123

I.e. it is simply false to say 7e

Page 123

If a false thought is so much as 86e

Page 123

If anyone should think he has solved 6e

Page 123

If certain graphic propositions 32e

Page 123

If Christianity is the truth, 89e

Page 123

If God really does choose those 83e

Page 123

If the believer in God looks around 96e

Page 123

If the dreams of sleep have a similar 83e

Page 123

If there is anything in the Freudian 50e

Page 123

If this stone won't budge at present, 44e

Page 123

If I am thinking just for myself 33e

Page 123

If I do not quite know how to begin 11e

Page 123

If I had written a good sentence, 66e

Page 123

If in life we are surrounded by death, 50e

Page 123

If I now ask "What do I actually experience 79e

Page 123

If I prepare myself for some eventuality, 90e

Page 123

If I realized how mean & petty I am 37e

Page 123

If I say A. has beautiful eyes 28e

Page 123

If I say: "that is the only thing that 29e

Page 123

If I say that my book is meant 12e

Page Break 124

Page 124

If it is said on occasion that 17e

Page 124

If it is true, as I believe, that Mahler's 76e

Page 124

If life becomes hard to bear we think 60e

Page 124	If one wanted to characterize the essence	27e
Page 124	If people did not sometimes commit stupidities,	57e
Page 124	If people find a flower or an animal	20e
Page 124	If someone can believe in God with complete	83e
Page 124	If someone is merely ahead of his time	11e
Page 124	If someone prophesies that the generation	29e
Page 124	If someone says, let's suppose, "A's eyes	27e
Page 124	If we think of the world's future	5e
Page 124	If we use the ethnological approach	45e
Page 124	If white turns to black some say:	49e
Page 124	If you already have someone's love,	48e
Page 124	If you ask: how I experienced the theme,	59e
Page 124	If you cannot unravel a tangle,	85e
Page 124	If you offer a sacrifice & then	30e
Page 124	If you use a trick in logic,	28e
Page 124	I have one of those talents that has	86e
Page 124	I just took some apples out of a paper bag	36e
Page 124	I look at the photographs of Corsican	15e
Page 124	Imagine someone watching a pendulum	86e
Page 124	I might say: if the place I want to reach	10e
Page 124	I must be nothing more than the mirror	25e
Page 124	I myself still find my way of philosophizing	3e
Page 124	In a bullfight the bull is the hero	58e
Page 124	In a conversation: One person throws	84e
Page 124	In a dream, & even long after we wake up,	75e
Page 124	In art it is hard to say anything,	26e
Page 124	In Beethoven's music what one might call	93e
Page 124	In Bruckner's music nothing is left	19e

	In Christianity it is as though God said"	21e
Page 124		
	I never before believed in God"	61e
Page 124		
	I never more than half succeed in expressing	16e
Page 124		
	In former times people entered monasteries	56e
Page 124		
	In Freudian analysis the dream is	78e
Page 124		
	In Mozart's or Haydn's music again fate	93e
Page 124		
	In my view Bacon was not a precise	61e
Page 124		
	In one day you can experience the horrors	30e
Page 124		
	In philosophizing it is important	31e
Page 124		
	In philosophy the winner of the race	40e
Page 124		
	In religion it must be the case	37e
Page 124		
	In Renan's Peuple d'Israël	7e
Page 124		
	In the course of a scientific investigation	73e
Page 124		
	In the course of our conversation Russell	35e
Page Break 125		
Page 125		
	In the days of silent films	29e
Page 125		
	In the Gospels--as it seems to me	35e
Page 125		
	In the train of every idea that costs	66e
Page 125		
	In the realm of the mind a project	87e
Page 125		
	In this world (mine) there is not tragedy	12e
Page 125		
	In Western Civilization the Jew	23e
Page 125		
	I often fear madness. Have I any reason	61e
Page 125		
	I often wonder whether my cultural	4e
Page 125		
	I once said, & perhaps rightly	5e
Page 125		
	I read: "philosophers are no nearer	22e
Page 125		
	I really do think with my pen,	24e
Page 125		
	I recently said to Arvid	5e
Page 125		
	Irony in music. E.g. Wagner	63e
Page 125		
	I sit astride life like a bad rider	42e

Page 125
Is it just I who cannot found a school, 69e

Page 125
Is it some frustrated longing that 51e

Page 125
Isochronism according to the clock 92e

Page 125
Is the sense of belief in the Devil 99e

Page 125
Is what I am doing in any way worth 66e

Page 125
It appears to me as though a religious 73e

Page 125
It could only be by accident that someone's 64e

Page 125
It has sometimes been said that the Jews' 19e

Page 125
I think Bacon got bogged down in 77e

Page 125
I think good Austrian work 5e

Page 125
I think it is an important & remarkable 84e

Page 125
I think it might be regarded as a fundamental 82e

Page 125
I think that, in order to enjoy a poet, 96e

Page 125
I think that present day education 81e

Page 125
I think there is some truth in my idea 16e

Page 125
I think today there could be a form of theatre 14e

Page 125
It is a great temptation to want 11e

Page 125
It is all one to me whether the typical 9e

Page 125
It is an accident that 'last' rhymes with 93e

Page 125
It is as though I had lost my way 53e

Page 125
It is difficult to form a good picture 94e

Page 125
It is difficult to know something, & to act 90e

Page 125
It is hard to tell someone who is shortsighted 3e

Page 125
It is hard to understand yourself properly 54e

Page 125
"It is high time for us to compare 62e

Page 125
It is humiliating having to present oneself 13e

Page 125
It is important for our approach, that someone 84e

Page 125
It is incredible how helpful a new 45e

Page 125

It is not as though S. portrayed human 96e
Page 125

It is not by any means clear to me, that I wish 70e
Page 125

It is not unheard of that someone's character 95e

Page Break 126

Page 126

It isn't reasonable to be furious even 53e
Page 126

It is often only very slightly more 45e
Page 126

It is often said that a new religion 23e
Page 126

It is one thing to sow in thought, 60e
Page 126

It is possible, that everyone who executes 67e
Page 126

It is remarkable how hard we find it 55e
Page 126

It is remarkable that Busch's drawings 85e
Page 126

It is very remarkable, that we should 57e
Page 126

It may be that science & industry, 72e
Page 126

It might also be said: hate between human 52e
Page 126

It might be said (rightly or wrongly) 16e
Page 126

I took the poem on the previous page 15e
Page 126

It's a good thing I don't let myself 3e
Page 126

It seems to me as though his pieces are 98e
Page 126

It seems to me I am still a long way 74e
Page 126

It seems to me (sometimes) as though 27e
Page 126

It's possible to write in a style 60e
Page 126

It's true you must assemble old material 46e
Page 126

It will be hard to follow my portrayal: 51e
Page 126

It would almost be strange if there 82e
Page 126

It would already be enough, that all members 85e

Page 126

Just as I cannot write verse 67e
Page 126

Just as someone may travel around 57e
Page 126

Just let nature speak 3e

Page 126
Kierkegaard writes: If Christianity 36e

Page 126
Kleist wrote somewhere that 23e

Page 126
Labor's seriousness is a very late 20e

Page 126
Labor, when he writes good music, 21e

Page 126
Language sets everyone the same traps; 25e

Page 126
"Le style c'est l'homme." 89e

Page 126
Lenau's Faust is remarkable in that 61e

Page 126
Let us be human.-- 36e

Page 126
Life is like a path along a mountain 72e

Page 126
Life's infinite variations are an 83e

Page 126
Longfellow: In the elder days 39e

Page 126
Look at human beings: One is poison 98e

Page 126
Looking for the fallacy in a fishy 49e

Page 126
"Look on this wart as a regular limb 18e

Page 126
Madness doesn't have to be regarded 62e

Page 126
Mendelssohn is like a man who is cheerful 4e

Page 126
Mendelssohn is not a peak 4e

Page Break 127

Page 127
(Mendelssohn's music, when it is flawless 23e

Page 127
Moore poked into a philosophical wasp nest 87e

Page 127
Music, with its few notes & rhythms 11e

Page 127
My 'achievement' is very much like 57e

Page 127
My ideal is a certain coolness 4e

Page 127
My originality (if that is the right word) 42e

Page 127
My own thinking about art & values 91e

Page 127
(My style is like bad musical composition.) 45e

Page 127
My thinking, like everyone's, has sticking 27e

Page 127

- Page 127
Neither could he regard himself as a prophet 96e
- Page 127
Nietzsche writes somewhere, that even the 67e
- Page 127
No one can think a thought for me 4e
- Page 127
No one likes having offended 13e
- Page 127
Not funk but funk conquered is what 43e
- Page 127
Nothing is more important though than the 84e
- Page 127
Nothing is so difficult as not deceiving 39e
- Page 127
Nothing seems to me more unlikely 70e
- Page 127
Nothing we do can be defended definitively 23e
- Page 127
Oh a key can lie for ever where 62e
- Page 127
Once again: what does it consist in, 58e
- Page 127
Once it is established the old problems 55e
- Page 127
One age misunderstands another; 98e
- Page 127
One & the same theme has a different 96e
- Page 127
One cannot speak the truth;--if 41e
- Page 127
One cannot view one's own character 26e
- Page 127
One could call Schopenhauer a quite crude 41e
- Page 127
One keeps forgetting to go down to the 71e
- Page 127
One might say: "Genius is courage 44e
- Page 127
One might say of Schopenhauer: he never 41e
- Page 127
One might say: what splendid laws 47e
- Page 127
One movement constructs 10e
- Page 127
One movement orders one thought to the 10e
- Page 127
One of my most important methods 45e
- Page 127
One uses straw to try to stuff 5e
- Page 127
Only by thinking much more crazily 86e
- Page 127
Only every so often does one of the sentences 76e

Page 127	Only in a quite particular musical context	93e
Page 127	Only someone very unhappy	53e
Page 127	Only something supernatural	5e
Page 127	Only where genius wears thin can	50e
Page 127	Or again no distress can be greater	52e
Page 127	Or what is it like for someone to have no	95e
Page Break 128		
Page 128	Our children learn in school	81e
Page 128	Our civilization is characterized	9e
Page 128	Our greatest stupidities may be	45e
Page 128	People are religious to the extent	51e
Page 128	People have sometimes said to me	33e
Page 128	People nowadays think, scientists	42e
Page 128	People who are constantly asking 'why'	46e
Page 128	Perhaps one day a culture will arise	73e
Page 128	Phenomena akin to language in music	40e
Page 128	(Philosophers are often like little children	24e
Page 128	Philosophers who say: "after death	26e
Page 128	Philosophy hasn't made any progress?	98e
Page 128	Piano playing, a dance of human fingers	42e
Page 128	Pieces of music composed at the keyboard	14e
Page 128	Power and possession are not the same	18e
Page 128	Put someone in the wrong atmosphere	48e
Page 128	Raisins may be the best part of a cake	76e
Page 128	Ramsey was a bourgeois thinker	24e
Page 128	Reading the Socratic dialogues,	21e
Page 128	Really I want to slow down the speed	77e
Page 128		

Page 128	Recounting a dream, a medley of	88e
Page 128	Reflect in this connection that in	94e
Page 128	Religion is as it were the calm sea	61e
Page 128	Religious faith & superstition	82e
Page 128	Religious similes can be said to move	34e
Page 128	Remember the impression made by good	26e
Page 128	Resting on your laurels is as dangerous	41e
Page 128	Schiller writes in a letter (to Goethe,	75e
Page 128	(Schopenhauer: the real life span	30e
Page 128	Schubert is irreligious & melancholy	53e
Page 128	Schubert's melodies can be said	54e
Page 128	Science, enrichment & impoverishment	69e
Page 128	Scientific questions may interest me,	91e
Page 128	Scraping away mortar is much	44e
Page 128	Shakespeare & the dream. A dream is all	89e
Page 128	Shakespeare, one might say,	42e
Page 128	Shakespeare's similes are,	56e
Page 128	Sketch for a Forward	8e
Page 128	Slept a bit better. Vivid dreams	31e
Page 128	So complicated, so irregular is the mode	51e
Page 128	Socrates, who always reduces the Sophist	64e
Page 128	Some people have a taste	73e

Page Break 129

Page 129	Sometimes a sentence can be understood	65e
Page 129	Sometimes it's as though you could see a	72e
Page 129	Sometimes one sees ideas, as an astronomer	66e
Page 129	Sometimes you have to take an expression	44e
Page 129	Someone divides human beings into buyers	26e

	Someone is imprisoned in a room	48e
Page 129	Someone reacts like this: he says "Not that!"	69e
Page 129	Someone who teaches philosophy nowadays	25e
Page 129	Someone who knows too much finds it hard	73e
Page 129	So perhaps it is similar to the concept	97e
Page 129	Soulful expression in music	94e
Page 129	Spengler could be better understood	21e
Page 129	Strike a coin from every mistake	79e
Page 129	Structure & feeling in music	20e
Page 129	Suppose someone were taught: There is a being	92e
Page 129	Suppose that 2000 years ago someone	49e
Page 129	Talent is a spring:	20e
Page 129	Taste can delight, but not seize	68e
Page 129	Taste is refinement of sensibility	68e
Page 129	Taste makes ACCEPTABLE	68e
Page 129	Taste rectifies, it doesn't give birth	68e
Page 129	Teaching this could not be an ethical	93e
Page 129	That I do not understand him could then	56e
Page 129	That must be the end of a theme	19e
Page 129	That writers, who after all were something,	90e
Page 129	'The aim of music: to communicate feelings.'	43e
Page 129	The beauty of a star-shaped figure	81e
Page 129	The book is full of life--not	71e
Page 129	The characters in a drama arouse our	47e
Page 129	The charming difference in temperature	13e
Page 129	The comparisons of the N.T.	42e
Page 129	The concept of a 'festivity'	89e
Page 129	"The cussedness of things"	81e
Page 129		

	The danger in a long foreword	10e
Page 129		
	The edifice of your pride has to be	30e
Page 129		
	The face is the soul	26e
Page 129		
	The faculty of 'taste' cannot create	68e
Page 129		
	The folds of my heart all the time	65e
Page 129		
	The fundamental insecurity of life	63e
Page 129		
	The greater "purity" of objects	30e
Page 129		
	The greatest happiness for a human being	87e
Page 129		
	The happy lover & the unhappy lover	86e
Page 129		
	The honest religious thinker is like	84e
Page 129		
	The human being is the best picture	56e
Page Break 130		
Page 130		
	The human gaze has the power	3e
Page 130		
	The hysterical fear of the atom bomb	55e
Page 130		
	The idea is worn out by now	24e
Page 130		
	The idea working its way towards the light	54e
Page 130		
	The impression (made by this melody)	42e
Page 130		
	The inexpressible (what I find enigmatic)	23e
Page 130		
	The Jew is a desert region	15e
Page 130		
	The Jew must in a real sense "make nothing"	16e
Page 130		
	The labour pains at the birth of new	71e
Page 130		
	The language used by philosophers	47e
Page 130		
	The last two bars of the "Death & the	60e
Page 130		
	The lesson in a poem is overstated,	62e
Page 130		
	The less somebody knows & understands	53e
Page 130		
	The Lieutenant & I have already	3e
Page 130		
	The light shed by work is a beautiful	30e
Page 130		
	The limit of language manifests itself	13e
Page 130		
	The mathematician (Pascal) who admires	47e

Page 130
The mathematician too can of course marvel 65e

Page 130
The measure of genius is character 40e

Page 130
The melodies of different composers 54e

Page 130
The miracles of nature, 64e

Page 130
The monstrous vanity of wishes is 41e

Page 130
The most refined taste 68e

Page 130
Then again you might think intensive 59e

Page 130
The 'necessity' with which the second idea 65e

Page 130
The Old Testament seen as the body 40e

Page 130
The only way for me to believe in a miracle 51e

Page 130
The only way namely for us to avoid prejudice 30e

Page 130
The origin & the primitive form 36e

Page 130
The overwhelming skill in Brahms 29e

Page 130
The philosopher easily gets into the position 24e

Page 130
The philosopher is someone who has to cure 50e

Page 130
The philosopher says "Look at things 70e

Page 130
The pleasure I take in my thoughts 20e

Page 130
The poet cannot really say of himself 96e

Page 130
The poet too must always be asking himself: 46e

Page 130
The popular scientific writings 48e

Page 130
The power of language to make everything 19e

Page 130
The problems of life are insoluble 84e

Page 130
The purely corporeal can be uncanny 57e

Page 130
The queer resemblance between a philosophical 29e

Page 130
The real achievement of a Copernicus 26e

Page 130
There are problems I never tackle 11e

Page 130
There are remarks that sow, 89e

Page 130
The reason I cannot understand Shakespeare 98e

There is a big difference between the effect 30e

There is definitely a certain kinship 18e

There is much that could be learned from 67e

There is much that is excellent in Macaulay's 31e

There is no greater distress to be felt 53e

There is no more light in a genius 41e

There is no religious denomination 3e

There is something Jewish in Rousseau's 17e

The remark by Jucundus in 'The Lost Laugh' 54e

"The repeat is necessary" In what respect 59e

There really are cases in which one has the sense 90e

The revolutionary will be the one who 51e

The Sabbath is not simply a time to rest, 91e

The saint is the only Jewish "genius" 16e

The story of Peter Schlemihl 21e

The spring that flows quietly & clearly 35e

The strength of the musical thinking 27e

The theme interacts with language 60e

The truly apocalyptic view of the world 64e

The truth can be spoken only by someone 41e

The use of the word "fate". Our 69e

The valleys of foolishness have more grass 92e

The various plants & their human 27e

The way whole periods are incapable of freeing 91e

The way you use the word "God" 58e

The whole Earth cannot be in greater distress 52e

The works of the great masters 23e

They have less style than the first speech 43e

Page 131	Think about how it was said of Labor's playing	71e
Page 131	"Thinking is difficult." (Ward)	85e
Page 131	Think of the demeanour of someone who draws	58e
Page 131	This is how philosophers should salute	91e
Page 131	This musical phrase is a gesture	83e
Page 131	Thoughts at peace	50e
Page 131	Thoughts rise to the surface slowly,	72e
Page 131	Today the difference between a good & a poor	5e
Page 131	To go down into the depths you don't need	57e
Page 131	Tolstoy: the meaning (importance) of	25e
Page 131	To piece together the landscape	90e
Page 131	To someone who is upset by this allegory	88e
Page 131	To treat well somebody who does not like you	13e
Page 131	Tradition is not something that	86e
Page 131	Troubles are like illnesses;	91e
Page 131	Try to be loved & not-admired	44e
Page 131	Two people who are laughing together,	88e
Page Break	132	
Page 132	Understanding & explaining a musical	79e
Page 132	Unshakable faith. (E.g. in a promise.)	84e
Page 132	Virtually as there is such a thing as a deep	48e
Page 132	Wagner's motifs might be called	47e
Page 132	Wanting to think is one thing,	50e
Page 132	We are engaged in a struggle with	13e
Page 132	(We are involved here with the Kantian	13e
Page 132	We are only going to set you straight	44e
Page 132	We are struggling with language	13e
Page 132		

We keep hearing the remark that philosophy 22e
Page 132
Well, of what do we say "it is in his power"? 87e
Page 132
Well, there is no mention of punishment here, 92e
Page 132
We must not forget: even our more refined, 83e
Page 132
We say: "You understand this expression 50e
Page 132
What a curious attitude scientists 46e
Page 132
"What a sensible man knows is hard 20e
Page 132
What does it consist in: following a musical 58e
Page 132
What Eddington says about the 'direction 25e
Page 132
What I am resisting is the concept 45e
Page 132
What I am writing here may be feeble 75e
Page 132
What is Good is Divine too 5e
Page 132
What is it like when people do not have 95e
Page 132
What is important about depicting anomalies 82e
Page 132
What is intriguing about a dream, 78e
Page 132
What is insidious about the causal 45e
Page 132
What is lacking in Mendelssohn's music? 40e
Page 132
What is pretty cannot be beautiful 48e
Page 132
What I want to say then is: 54e
Page 132
What Renan calls the bon sens précoce 8e
Page 132
What's ragged should be left 51e
Page 132
What you are taking for a gift is a problem 49e
Page 132
What you have achieved cannot mean 15e
Page 132
When he was old Charlemagne tried 85e
Page 132
When I came home I expected a surprise 52e
Page 132
When I have had a picture suitably framed 17e
Page 132
When I imagine a piece of music, 32e
Page 132
When people have died we see their life 53e
Page 132
When philosophizing you have to descend 74e

Page 132

When you bump against the limits 11e

Page 132

Where genius wears thin skill may 49e

Page 132

Where others go on ahead, I remain 75e

Page 132

Where there is bad management in the state, 72e

Page 132

Why is the soul moved by idle thoughts 41e

Page Break 133

Page 133

Why shouldn't I apply words in opposition 50e

Page 133

Why shouldn't someone become desperately 92e

Page 133

"Wisdom is grey." Life on the other hand 71e

Page 133

Wisdom is something cold, & to that extent 64e

Page 133

Within all great art there is a WILD 43e

Page 133

With my full philosophical rucksack 4e

Page 133

With thinking too there is a time for 33e

Page 133

Words are deeds. Only someone very unhappy 53e

Page 133

Work on philosophy--like work in 24e

Page 133

Writing the right style means, 44e

Page 133

"Yes, that's how it is," you say, 30e

Page 133

You can as it were restore an old style 68e

Page 133

You cannot draw the seed up out 48e

Page 133

You cannot judge yourself, if you are not 99e

Page 133

You cannot lead people to the good 5e

Page 133

You cannot write more truly about yourself 38e

Page 133

You can't be reluctant to give up your lie 44e

Page 133

You can't construct clouds 48e

Page 133

You could attach prices to ideas 60e

Page 133

You get tragedy where the tree 3e

Page 133

You must accept the faults in your own 86e

Page 133

You must indeed say only what is 46e

You must say something new & yet 45e

FOOTNOTES

†1 But see Note by Translator.

†* The *Wittgenstein Archive of the University of Bergen* is producing a machine-readable version of the complete philosophical remains of Wittgenstein.

†** Mr Pichler published a list of the sources of *Vermischte Bemerkungen* in Spring 1991: Alois Pichler, "Ludwig Wittgenstein, Vermischte Bemerkungen: Liste der Manuskriptquellen. Ludwig Wittgenstein, Culture and Value: A List of Source Manuscripts", *Skriftserie fra Wittgensteinarkivet ved Universitetet i Bergen* 1 (1991)

†* Georg Henrik von Wright

†a as

†b wonderful

†a activity

†b function

†c from its

†d contemplating it from above from its flight

†e contemplating it from its flight

†a have no need

†b can

†c have

†d us

†e the ones

†f its spirit

†g the current of the

†h our day's

†i alien and uncongenial

†j he believed that--

†k were architecture & not

†a they are as it were

†a picks up one stone after another

- †b those who
Page 10
- †c is noticed only by those
Page 10
- †d because it immediately | at once putrefies
Page 11
- †a its foreground
Page 12
- †a described
Page 12
- †b presentiment
Page 12
- †c outcome
Page 12
- †d world ether
Page 12
- †e become nothing splendid
Page 12
- †f a
Page 12
- †g these are the people to whom
Page 14
- †a would like
Page 14
- †b wear a *quite* different character
Page 14
- †c <stylized> types.
Page 15
- †a The *whole* rhythm of the poem...
Page 15
- †b be
Page 18
- †a ... could be called a matter of temperament & a much larger proportion of disagreements rest on this than may appear.
Page 18
- †b swelling
Page 18
- †c & nobody wants to speak of a disease as though it had the same rights as healthy bodily processes (even painful ones).
Page 20
- †a according to
Page 20
- †b two different
Page 20
- †c made use of
Page 20
- †d And with the beginning I am now thinking of for my book, the description of nature with which it is to start?
Page 21
- †a read
Page 21
- †b holds
Page 21
- †c of the comparison
Page 21
- †d will not have the
Page 22

†a has to be so
Page 22

†b transcendent
Page 22

†c strange
Page 22

†d could <get>
Page 23

†a themselves
Page 23

†b suns
Page 23

†c But with the Jews it is just the same.
Page 23

†d them
Page 23

†e they are
Page 23

†f thinkers
Page 24

†a a <work>
Page 24

†b while seeing <to it>
Page 24

†c then
Page 25

†a is no bigger
Page 25

†b --teacher of philosophy is like a person, someone, who gives his pupil foods, not |
Page 25

†c accessible
Page 26

†a draw his attention to this
Page 26

†b know
Page 27

†a remains
Page 27

†b but what he means to us is all the same only *his* personality
Page 27

†c already now
Page 28

†a one of the narrow def<initions [[sic > ?]] o<f> t<the>
Page 30

†a read
Page 30

†b the
Page 30

†c our claims
Page 30

†d regard
Page 30

†e rather than
Page 30

†f would have to
Page 30

†g In this <namely> lies

Page 30

†h our philosophy

Page 31

†a look up

Page 31

†b , to master it,

Page 31

†c but the question constantly arises: should this game be played at all now & what is the right game?

Page 32

†a of all <opinions>

Page 33

†a a hindrance which nullifies the movement by friction

Page 33

†b has the same effect

Page 33

†c but a weight attached to one's foot, which will not allow us to walk *far*.

Page 33

†d say from time to time

Page 33

†e ;|:

Page 33

†f as it is

Page 33

†g Similarly,

Page 33

†h flowers, berries or herbs

Page 33

†i although

Page 34

†a :

Page 35

†a both he and I

Page 35

†b in

Page 35

†c additional

Page 35

†d that might retrospectively be thought of,

Page 35

†e Our experience was that language could continually make new, & impossible, demands; & in this way every explanation was frustrated.

Page 35

†f could <show our earlier explanation to be unworkable>--frustrating every attempt at explanation.--

Page 35

†g transparently

Page 36

†a in me

Page 36

†b was

Page 36

†c as that of someone <when> he <struggle>s <in vain>

Page 36

†d occurred

Page 38

†a are permitted <only> to

Page 39

†a the

Page 39
†b are not blood relations but stand to each other

Page 39
†c written *against* Beethoven's & because of this

Page 40
†a he who gets there last.

Page 40
†b arrives last.

Page 40
†c may be similar to eating from the tree of knowledge.

Page 41
†a air

Page 41
†b by

Page 41
†c :

Page 42
†a of understanding

Page 42
†b have no bottom.

Page 43
†a its *depth*

Page 43
†b :

Page 43
†c even

Page 43
†d on the occasions when

Page 43
†e is making

Page 44
†a withdraw <an expression from the language>

Page 44
†b *straight*

Page 44
†c Driving

Page 44
†d , that is if your carriage stands | stood on the rails crookedly. You can drive then by yourself.

Page 45
†a -

Page 45
†b had to

Page 45
†c manners

Page 45
†d had

Page 46
†a break them open

Page 46
†b ,

Page 47
†a about numbers

Page 47
†b the regularities of a sort of *crystal*

Page 48
†a ... scientists do not express (hard) work, but resting on laurels.

Page 48

†b ... do not express hard work, but are the expression of resting on laurels.

Page 48

†c much

Page 48

†d You give it warmth...

Page 48

†e *take hold of*

Page 49

†a became

Page 49

†b any

Page 49

†c without any idea that, & how, it could be used as a motor

Page 49

†d skill

Page 49

†e look <through>

Page 50

†a the scientist

Page 50

†b experience

Page 50

†c ,

Page 50

†c [[sic, d?]] Someone says to us:

Page 50

†d [[sic, e?]] with the meaning known to you

Page 50

†f Well then, I too am using it with the meaning that you know."

Page 50

†g , which the word takes with it & carries over into whatever | every kind of application.

Page 50

†h takes with it

Page 50

†i so too in our everyday understanding by madness.

Page 51

†a paints

Page 52

†a outstanding

Page 54

†a --<if things are going well for him now>--

Page 55

†a a nuance of stress

Page 55

†b the new way of thinking

Page 55

†c , the old problems are put on one side along with the old garment

Page 56

†a of his total output

Page 57

†a seem to you like narrow borders.

Page 57

†b indeed for this you need not even leave your most immediate & familiar surroundings I need not for this <leave> your most immediate...

Page 57

†c tucked away

Page 57

†d .

Page 57

†e a mathematician's.

Page 57

†f the forms in which

Page 58

†a ,--

Page 58

†b <with feeling>

Page 58

†c of that

Page 58

†d the outward manifestation is?.

Page 58

†e ask yourself, what the expression of that is.

Page 59

†a while

Page 60

†a lie

Page 60

†b Experience has incorporated the picture into our thinking.

Page 60

†c a change of situation

Page 60

†d change,

Page 60

†e <we can> hardly | <only> with difficulty decide <on this>.

Page 60

†f bits & pieces

Page 61

†a Someone might <*fantasize* a flying machine, without being precise about its details. Outwardly> he <may>

Page 62

†a <a> vision

Page 62

†b to unlock

Page 62

†c <these phenom>ena

Page 63

†a these pictures

Page 63

†b rather: *that's how it has changed.*

Page 64

†a :

Page 65

†a then he is looking at?

Page 65

†b they

Page 65

†c affected

Page 66

†a that

Page 66

†b would like to defend

Page 66

†c appearing

Page 66

†d attitude

Page 66

†e <esteem> you <& at the same time *love*> you <can make this behaviour easy> for you you

Page 66

†f , & if | they had by accident become a pair of lines that rhymed (with each other),...

Page 66

†g , & it by accident they had become two rhyming lines,...

Page 66

†h , & it turned out by accident to read as two rhyming lines,...

Page 67

†d [[sic a?]] bad

Page 67

†a [[sic b?]] not impossible

Page 67

†b [[sic c?]] simply

Page 67

†c [[sic d?]] <by> their

Page 68

†a Taste rectifies. Giving birth is not its affair.

Page 68

†b <does> not <need>

Page 68

†c Even the

Page 68

†d am *not* able to

Page 68

†e newer

Page 68

†f <an> interpretation

Page 68

†g in a tempo that

Page 69

†a in reality

Page 70

†a observations

Page 71

†a through

Page 71

†b becomes

Page 71

†c would be

Page 71

†d change women's & men's dress

Page 71

†e the

Page 71

†f We should like to call music a 'language'; & no doubt this does apply to *some* music--& to some no doubt not.

Page 72

†a is

Page 72

†b very close

Page 72

†c slippery

Page 72

†d one or the other

Page 73

†a a system of reference
Page 73

†b the <rescue>-instrument
Page 73

†c <but> certainly not
Page 73

†d certainly not however
Page 74

†a transitions between thoughts
Page 74

†b forms
Page 74

†c because it is a gesture that endures
Page 75

†a with
Page 75

†b better
Page 76

†a understandable
Page 77

†a my copious
Page 78

†a discover
Page 78

†b tale
Page 78

†c ask
Page 78

†d exclaim
Page 79

†a idea pregnant with further developments
Page 79

†b banalities
Page 79

†c recollections
Page 80

†a :
Page 80

†b a distinction like that between seeing, hearing & smelling.
Page 80

†c understanding
Page 80

†d at another time
Page 81

†a <an> explanation
Page 82

†a his body
Page 82

†b does not have the right to <disregard this perception>
Page 82

†c delusive
Page 82

†d it
Page 83

†a <do you> have a right to
Page 84

†a by

Page 84

†b footing

Page 84

†c seduced

Page 85

†a than fictional concepts,

Page 85

†b distinctly

Page 85

†c you can <not unravel a tangle, then the most sensible thing that> you can <do>

Page 86

†a the freedom

Page 86

†b someone

Page 86

†c learn

Page 86

†d can choose the ancestors from whom you would like to be descended.

Page 87

†a for a new sowing.

Page 88

†a their

Page 88

†b that

Page 88

†c used

Page 89

†a constantly

Page 89

†b are in a process of perpetual change.

Page 90

†a Piecing together

Page 90

†b Piecing together <the landscape of these conceptual relationships> out of their individual fragments, as language reveals them to us,

Page 90

†c S<omeone>

Page 90

†d he

Page 90

†e one

Page 90

†f as though one saw a dream image quite clearly before one's mind's eye, but could not describe it in such a way that someone else sees it too.

Page 91

†a intrigue

Page 91

†b through the questions into the open, sometimes...

Page 92

†a derive <only despair or incredulity> from this doctrine.

Page 93

†a *find*

Page 93

†b becomes

Page 95

†a <There is> nothing unheard of in the idea

Page 95

†b nothing unheard of

Page 95

†c <circumstances> of this nature

Page 96

†a Major & minor in Schubert

Page 96

†b only a cold admiration is possible.

Page 97

†a <an> attitude

Page 97

†b particular

Page 97

†c & does not know how it can be expressed.

Page 98

†a response to the itch

Page 98

†b continue

Page 99

†a comes from the good

Page 100

†a The rhythms of the German are only roughly suggested; and no attempt has been made to reproduce the rhymes in the original.

TRANSLATOR'S NOTES

Page xvi

†i A noun, which in conventional German orthography would begin with an upper case "P".

Page xvi

†ii More conventionally "jeder so und so viele".

Page xvii

†i Such messages have in the main been rendered somewhat differently in the translation. Footnotes (like this one) numbered with small Roman numerals have been added by the translator.

Page 13

†i In German the irony is intensified by a play on the words *geduldig* and *duldend*.

Page 15

†i This is something like a crossword puzzle. Each space is occupied by a separate syllable. These are joined together to form a meaningful passage by making transpositions according to the knight's move (= *Rösselsprung*) in chess.

Page 16

†i The phrase in quotation marks is adapted from the first line of Goethe's poem, "Vanitas! Vanitatis vanitas" which in its turn is the title of the first chapter of Max Stirner's *Der Einzige und sein Eigentum*. Wittgenstein is here probably alluding more directly to Stirner than to Goethe, the sense of whose poem hardly fits the present context. The translator is indebted to the late Rush Rhees for drawing his attention to these allusions.

Page 19

†i Literally: "which I do not know".

Page 20

†i "Wissenschaft" and "wissenschaftlich" in this sentence have been translated as "science" and "scientific". However, Wittgenstein probably did not mean this in the sense of natural science (which is the most common English usage) but, according to natural German usage, was thinking of intellectual questions in a much more general way.

Page 22

†i The translator is grateful for this rendering to Mr S. Ellis of the Institute of Dialect and Folk Life Studies at the University of Leeds.

Page 32

†i The variant Wittgenstein wrote at this point consists of putting the clause expressing indirect speech into the subjunctive--which is grammatically correct in German but not, at least in this context, in English. One might translate the variant by rewriting the sentence: "People would live under an absolute, palpable tyranny, yet without

being able to say they were not free."

Page 34

†i The alternative versions "es" and "sie" have, in this context, no grammatical equivalent in English.

Page 36

†i Wittgenstein's variant here consists in supplying a capital A for the noun form "Anderes". There is no English counterpart for this grammatical move.

Page 36

†ii Goethe, *Faust*, Part I (In the Study).

Page 38

†i 1 *Corinthians*, 3.

Page 39

†i Lars Hertzberg has pointed out to me that Wittgenstein misquotes here. The last line of the stanza reads: "For the Gods see everywhere."

Page 42

†i New Testament

Page 58

†i Wittgenstein's alternative reading "wird" for "ist" does not correspond to any meaningful distinction in English.

Page 58

†ii The grammatical variant in Wittgenstein's German text has no meaningful counterpart in English.

Page 59

†i I think "field" here should be understood in the sense of a "field of force", as in physics.

Page 69

†i This could also be translated by the weaker "I actually do not want to be imitated".

Page 70

†i See translator's note on p. 46.

Page 71

†i The variant Wittgenstein gives here is simply a German version of the English phrase he originally used.

Page 72

†i Wittgenstein's alternative versions, "in dem" or "in welchem", do not correspond to any distinction in English.

Page 74

†i This could also be rendered as "the former chaos".

Page 76

†i The German text plays on the two cognate verbs "anregt" (= "stimulates") "aufregt" (= exasperates).

Page 81

†i This is the idiomatic phrase corresponding to the German. However, the reader's attention is drawn to two points. [1] "Cussedness" here translates the German "Tücke", which in other contexts sounds rather stronger than would "cussedness" in English. In this passage, therefore, outside the context of the particular idiom it has been rendered as "malice". [2] The plural "things" corresponds to the German singular "des Objekts". This may be important insofar as Wittgenstein interprets the idiomatic phrase under discussion as implying a demonic intervention *in particular cases*; whereas, in English at least, the phrase is quite compatible with the conception Wittgenstein here develops in opposition to such an implication.

Page 84

†i The justification for translating the variants thus is the slenderest imaginable...

Page 90

†i I am reading "U.u." as an idiosyncratic version of "U.U." (= "Unter Umständen"). It has been suggested to me that it could stand for "Und umgekehrt". However, (a) "And vice versa" seems to make little sense applied to the preceding sentence; and (b) "U.u." is not a recognized abbreviation for "Und umgekehrt"--in Germany at least; I am not sure about Austria.

Page 93

†i In the German 'Rast' (= 'rest') and 'Hast' (= 'haste').

Page 95

†i Literally: "No human being must must"

Page 97

†i "Craving" is too strong for "Verlangen" in this context; "desire" is too weak. The vulgarity "hankering" strikes me as just right.

ZETTEL

Titlepage

LUDWIG WITTGENSTEIN

ZETTEL

Second Edition

Edited by
G. E. M. ANSCOMBE
and G. H. von WRIGHT
Translated by
G. E. M. ANSCOMBE

BASIL BLACKWELL
OXFORD

Page Break ii

Copyright page

Page ii

Copyright © Blackwell Publishers Ltd 1967, 1981

First edition 1967
First published in paperback 1975
Second edition 1981
Reprinted 1988, 1990, 1998

Blackwell Publishers Ltd
108 Cowley Road
Oxford OX4 1JF, UK

All rights reserved. Except for the quotation of short passages for the purposes of criticism and review, no part of this publication may be reproduced, stored in a retrieval system, or transmitted, in any form or by any means, electronic, mechanical, photocopying, recording or otherwise, without the prior permission of the publisher.

Except in the United States of America, this book is sold subject to the condition that it shall not, by way of trade or otherwise, be lent, resold, hired out, or otherwise circulated without the publisher's prior consent in any form of binding or cover other than that in which it is published and without a similar condition including this condition being imposed on the subsequent purchaser.

ISBN 0 631 12813 1
ISBN 0 631 12823 9 (pbk)

Printed in Great Britain by Athenaeum Press Ltd,
Gateshead, Tyne & Wear

Page Break iii

EDITORS' PREFACE

Page iii

WE publish here a collection of fragments made by Wittgenstein himself and left by him in a box-file. They were for the most part cut from extensive typescripts of his, other copies of which still exist. Some few were cut from typescripts which we have not been able to trace and which it is likely that he destroyed but for the bits that he put in the box. Others again were in manuscript, apparently written to add to the remarks on a particular matter preserved in the box.

Page iii

The earliest time of composition of any of these fragments was, so far as we can judge, 1929. The date at which the latest datable fragment was written was August 1948. By far the greatest number came from typescripts which were dictated from 1945-1948.

Page iii

Often fragments on the same topic were clipped together; but there were also a large number lying loose in the box. Some years ago Peter Geach made an arrangement of this material, keeping together what were in single bundles, and otherwise fitting the pieces as well as he could according to subject matter. This arrangement we have retained with a very few alterations. We hereby express our indebtedness to him for the work that he did, which was laborious and exacting. Though the arrangement is not the kind of arrangement that Wittgenstein made of his 'remarks', we found that it made a very instructive and readable compilation.

Page iii

We were naturally at first rather puzzled to account for this box. Were its contents an accidental collection of left-overs? Was it a receptacle for random deposits of casual scraps of writing? Should the large works which were some of its sources be published and it be left on one side? One of these works was one of two total rearrangements of *Investigations* and other material; another was an extremely long and repetitive early typescript presenting great editorial problems. Another--though there are only a few cuttings from this source--has already been published under the title *Philosophische Bemerkungen*.

Page Break iv

Page iv

After most of the typed fragments had been traced to their sources, comparison of them with their original forms, together with certain physical features, shewed clearly that Wittgenstein did not merely keep these fragments, but worked on them, altered and polished them in their cut-up condition. This suggested that the addition of separate MS pieces to the box was calculated; the whole collection had a quite different character from the various bundles of more or less 'stray' bits of writing which were also among his Nachlass.

Page iv

We therefore came to the conclusion that this box contained remarks which Wittgenstein regarded as particularly useful and intended to weave into finished work if places for them should appear. Now we know that his method of composition was in part to make an arrangement of such short, almost independent pieces as, in the enormous quantity that he wrote, he was fairly satisfied with.

Page iv

Not every one of these remarks is quite of this kind; very occasionally the cutting was grammatically incomplete, so that it looked as if it were preserved only for the sake of the idea or expression to be seen on it. Here we have supplied the missing words from the original typescript where we could; once we had to supply the last few words ourselves. Very rarely, there is a pronoun or the like demanding a previous reference to explain it; once we supplied the preceding remark from the original typescript; once or twice we have put in appropriate words. Square brackets are the editors'; e.g. when Wittgenstein wrote a mere note on his text in the margin we have printed it, prefaced by the words 'Marginal note', between square brackets. Elsewhere words between square brackets have been supplied by us.

G. E. M. ANSCOMBE
G. H. VON WRIGHT

Page Break v

TRANSLATOR'S NOTE

Page v

I am indebted for the avoidance of many errors in the translation and for various helpful suggestions to Dr. L. Labowsky, Professor G. H. von Wright, Mr. R. Rhees and Professor P. T. Geach. Only I am to blame for any errors that remain.

G. E. M. A.

PREFACE TO THE SECOND EDITION

A CLOSE comparison of the printed text with the original cuttings has shewn that the first edition was marked by many inaccuracies, and even some misunderstandings of the original text. (See, e.g., § 671.) They have been corrected. The editors are grateful to Mr. Heikki Nyman for his laborious and conscientious work towards the production of a printed text that is faithful to the sources.

G. E. M. ANSCOMBE
G. H. VON WRIGHT

[Zettel: Main Body]

1. William James: The thought is already complete at the beginning of the sentence. How can one know that?--But the *intention* of uttering the thought may already exist before the first word has been said. For if you ask someone: "Do you know what you mean to say?" he will often say yes.

2. I tell someone: "I'm going to whistle you the theme... ", it is my intention to whistle it, and I already know what I am going to whistle.

It is my intention to whistle this theme: have I then already, in some sense, whistled it in thought?

3. "I'm not just *saying* this, I mean something by it."--Should one thereupon ask "What?" then one gets another sentence in reply. Or perhaps one cannot ask that, as the sentence meant, e.g. "I'm not just *saying* this, it moves me too".

4. (The question "What do I mean by that?" is one of the most misleading of expressions. In most cases one might answer: "Nothing at all--I *say*...".)

5. Can I then not use words to mean what I like? Look at the door of your room, utter a sequence of random sounds and mean by them a description of that door.

6. "Say 'a b c d' and mean: the weather is fine."--Should I say, then, that the utterance of a sentence in a familiar language is a quite different experience from the utterance of sounds which are not familiar to us as a sentence? So if I learnt the language in which "*abcd*" meant that--should I come bit by bit to have the familiar experience when I pronounced the letters? Yes and no.--A major difference between the two cases is that in the first one I *can't move*. It is as if one of my joints were in splints, and I not yet familiar with the possible movements, so that I as it were keep on stumbling.

7. If I have two friends with the same name and am writing one of them a letter, what does the fact that I am not writing it to the other consist in? In the content? But that might fit either. (I haven't yet written the address.) Well, the connexion might be in the antecedents. But in that case it may also be in what *follows* the writing. If someone asks me "Which of the two are you

writing to?" and I answer him, do I infer the answer from the antecedents? Don't I give it almost as I say "I have toothache"?--Could I be in doubt which of the two I was writing to? And what is a case of such a doubt like?--Indeed, couldn't there also be an illusion of this kind: I believe I am writing to one of them when in fact I am writing to the other? And what would such a case of illusion look like?

8. (One sometimes says: "What was I going to look for in this drawer?--Oh yes, the photograph!" Once this has occurred to us, we recall the connexion between our actions and what was happening before. But the following is also possible: I open the drawer and rattle around in it; at last I come to and ask myself "Why am I rummaging in this drawer?" And then the answer comes, "I want to look at the photograph of...". "*I want to*", not "*I wanted to*". Opening the drawer, etc. happened so to speak automatically and got interpreted *subsequently*.)

9. "That remark of mine was aimed at *him*." If I hear this I can imagine a situation and a history that fit it. I could present it on the stage, project myself into the state of mind in which I 'aim at him'.--But how is this state of mind to be described, i.e. to be identified?--I think myself into the situation, assume a certain expression and tone, etc.. What

connects my words with him? The situation and my thoughts. And my thoughts in just the same way as things I say out loud.

Page 2

10. Suppose I wanted to replace all the words of my language at once by other ones; how could I tell the place where one of the new words belongs? Is it images that keep the places of the words?

Page 2

11. I am inclined to say: I 'point' *in different senses* to this body, to its shape, to its colour, etc.--What does that mean?

What does it mean to say I 'hear' *in a different sense* the piano, its sound, the piece, the player, his fluency? I 'marry', in one sense a woman, in another her money.

Page 2

12. Here meaning gets imagined as a kind of mental pointing, indicating.

Page Break 3

Page 3

13. In some spiritualistic procedures it is essential to *think* of a particular person. And here we have the impression that 'thinking of him' is as it were nailing him with my thought. Or it is as if I kept on thrusting at him in thought. For the thoughts keep on swerving slightly away from him.

Page 3

14. "Suddenly I had to think of him." Say a picture of him suddenly floated before me. Did I know that it was a picture of him, N.? I did not tell myself it was. What did its being of him consist in, then? Perhaps what I later said or did.

Page 3

15. When Max says "The prince has a fatherly concern for the troops", he means Wallenstein.--Suppose someone said: We don't know that he means Wallenstein: he might mean some other prince in this sentence.† 1

Page 3

16. "Your meaning the piano-playing consisted in your *thinking* of the piano-playing."

"That you meant that man by the word 'you' in that letter consisted in this, that you were writing to *him*."

The mistake is to say that there is anything that meaning something consists in.

Page 3

17. "When I said that, I only wanted to drop a hint."--How can I know that I said it only to drop a hint? Well, the words "When I said it, etc." describe a particular intelligible situation. What is that situation like? In order to describe it, I must describe a context.

Page 3

18. How does *he* enter into these proceedings:

I thrust at him,
I spoke to him,
I called him,
I spoke of him
I imagined him,
I esteem him?

Page 3

19. It is wrong to say: I meant him *by* looking at him. "Meaning" does not stand for an activity which wholly or partly consists in the 'utterances' [outward expressions] of meaning.

Page Break 4

Page 4

20. Hence it would be stupid to call meaning a 'mental activity', because that would encourage a false picture of the function of the word.

Page 4

21. I say "Come here" and point towards A. B, who is standing by him, takes a step towards me. I say "No; A is to come". Will that be taken as a communication about my mental state? Certainly not.--Yet couldn't inferences be made from it about processes going on in me when I pronounced the summons "Come here"?

But what kind of processes? Mightn't it be conjectured that I looked at A as I gave the order? That I directed my thoughts towards him? But perhaps I don't know B at all; I am in touch only with A. In that case the man who guessed at my mental processes might have been quite wrong, but all the same would have understood that I meant

A and not B.

Page 4

22. I point with my hand and say "Come here". A asks "Did you mean me?" I say: "No, B".--What went on when I meant B (since my pointing left it in doubt which I meant)?--I said those words, made that gesture. Must still more have taken place, in order for the language-game to take place? But didn't I already know, while I was pointing, whom I meant? Know? Of course--going by the usual criteria for knowledge.

Page 4

23. "What I wanted to get at in my account was....". This was the objective I had before me. In my mind I could see the passage in the book, that I was aiming at.

Describing an intention means describing what went on from a particular point of view, with a particular purpose. I paint a particular portrait of what went on.

Page 4

24. Instead of "I meant *him*" one may also say "I was speaking of *him*". And how does one do that, how does one speak of *him* in speaking those words? Why does it sound wrong to say "I spoke of him by pointing to him as I spoke those words"?

"To mean him" means, say, "to talk of him". Not: to point to him. And if I talk *of him*, of course there is a connexion between my talk and him, but this connexion resides in the application of the talk, not in an act of pointing. Pointing is itself only a sign,

Page Break 5

and in the language-game it may direct the application of the sentence, and so shew what is meant.

Page 5

25. If I say "I saw a chair in this room", I can mostly recall the particular visual impression only very roughly, nor does it have any importance in most cases. The use that is made of the sentence bypasses this particular feature. Now is it also like that when I say "I meant N"? Does this sentence bypass the particular features of the proceeding in the same way?

Page 5

26. When I make a remark with an allusion to N., I may let this appear--given particular circumstances--in my glance, my expression, etc.

Page 5

You can shew that you understand the expression "to allude to N." by describing examples of alluding. What will you describe? First of all, circumstances. Then what someone says. Perhaps his glance etc. as well. Then what someone making an allusion is trying to do.

Page 5

And if I go on to tell someone the feelings, images etc. which I had while I was making the remark, these may fill out the typical picture of an allusion (or *one* such picture). But it doesn't follow that the expression "alluding to N" means: behaving like this, feeling this, imagining this, etc. And here some will say: "Of course not! We knew that all along. A red thread must run through all these phenomena. It is, so to speak, entangled with them and so it is difficult to pick out."--And that is not true either.

Page 5

But it would also be wrong to say that "alluding" stands for a family of mental and other processes.--For one can well ask "Which was your allusion to N.?" "How did you give others to understand that you meant N.?"; but not: "How did you mean this utterance as an allusion to N.?"

Page 5

"I alluded to him in my talk."--"When you said what?"--"I was alluding to him when I spoke of a man who...."

Page 5

"I was alluding to him" means roughly: "I *wanted* someone to think of him at these words. But "I wanted" is not the description of a state of mind. Neither is "understanding that N was meant" such a description. [*Marginal note*: But one does ask: "In which remark did you allude to him?", "Which" was the remark where you meant him?"]

Page Break 6

Page 6

27. When the situation is ambiguous, is it doubtful whether I mean him? When I say that I did or did not mean him, I don't go by the situation. And if not by the situation, what do I go by? Apparently not by anything at all. For I do remember the situation, but I *interpret* it. I may, e.g., *now imitate* my sidelong glance at him; but *meaning* him appears as a quite impalpable fine atmosphere of the speaking and acting. (A fishy picture!)

28. In the course of a conversation I want to point at something; I have already begun a pointing movement, but I don't complete it. Later on I say "I was going to point to it then. I still remember quite clearly that I was already raising my finger." In the current of those events, thoughts, and experiences, that was the beginning of a pointing gesture.

And if I completed the gesture and said: "He is lying over there", this would not be a case of pointing unless these words belonged to a language.

29. "You moved your hand--did you mean anything by the movement?--I thought you meant me to come to you."

So he may have meant something or nothing. And if the former, then was it the movement that he meant--or something else? When he used an expression, did he mean something other than the expression or did he simply *mean* the expression?

30. Could one also reply: "I meant something by this movement, which I can only express by this movement"? (Music, musical thought.)

31. "Of course I was thinking of him: I saw him in my mind's eye!"--But I did not *recognize* him by his appearance.

32. Imagine someone you know.--Now say who it was.--Sometimes the picture comes first and the name afterwards. But do I guess the name by the picture's likeness to the man?--And if the name only comes after the picture--was the idea of that man there as soon as the picture was, or was it only complete when I had the name? I did not infer the name from the picture; and just for that reason I can say that the idea of him was already there once the picture was there.

33. It is as if one experienced a *tendency*, a readiness (James). And why shouldn't I call it that? (And some would explain what happens here by innervations of muscles, dispositions to move, or even images of movement.) Only there is no need to see the experience of a tendency as a not quite complete experience.

It often strikes us as if in grasping meaning the mind made small rudimentary movements, like someone irresolute who does not know which way to go--i.e. it tentatively reviews the field of possible applications.



34. Imagine humans who from childhood up scribble very fast as they talk: as it were illustrating what they say.

Must I assume that if someone draws or describes or imitates something from memory, he *reads off* his representation from something or other?!--What supports this?

35. Guessing thoughts. There are playing-cards on the table. I want the other man to touch one. I shut my eyes and think of one of the cards; the other is supposed to guess which I mean.--He makes himself think of a card, and at the same time wills to hit on the one I mean. He touches the card and I say "Yes, that was it"; or else it wasn't. A variant of this game would be for me to *look* at a particular card, but so that the other can't see the direction of my gaze; he has to guess the card I am looking at. It is important that this is a variant of the other game. Here it may be important *how* I think of the card, because it might turn out that the reliability of the guessing depended on that. But if I say in ordinary life: "I thought of so-and-so" I am not asked "*How* did you think of him?"

36. One would like to ask: "Would someone who could look into your mind have been able to see that you *meant* to say *that*?"

Suppose I had written my intention down on a slip of paper, then someone else could have read it there. And can I imagine that he might in some way have found it out *more surely* than that? Certainly not.

37. (At the beginning of a piece of music it says  = 88, written there by the composer. But in order to play it right nowadays it must be played  = 94: which is *the tempo intended by the composer*?)

38. Interrupt a man in quite unpremeditated and fluent talk. Then ask him what he was going to say; and in many

cases he will be able to continue the sentence he had begun.--"For that, what he was going to say must already have swum into view before his mind."--Is not that phenomenon perhaps the ground of our saying that the continuation had swum into his mental view?

Page 8

39. But is it not peculiar that there is such a thing as this reaction, this confession of intention? Is it not an extremely remarkable instrument of language? What is really remarkable about it? Well--it is difficult to imagine how a human being learns this use of words. It is so very subtle.

Page 8

40. But is it really subtler than that of the phrase "I imagined him", for example? Yes, every such use of language is remarkable, peculiar, if one is adjusted only to consider the description of physical objects.

Page 8

41. If I say "I was then going to do such-and-such", and if this statement is based on the thoughts, images etc. which I remember, then someone else to whom I tell only these thoughts, images etc. ought to be able to infer with as great certainty as mine that I was then going to do such-and-such.--But often he could not do so. Indeed, were I myself to infer my intention from the evidence, other people would be right to say that this conclusion was very uncertain.

Page 8

42. And how does [a child] learn to use the expression "I was just on the point of throwing then"? And how do we tell that he was then really in that state of mind then which I call "being on the point of"?

Page 8

43. Suppose a human being never learnt the expression "I was on the point of" or "I was just going to..." and could not learn their use? A man can after all think a good deal without thinking *that*. He can master a great field of language-games without mastering this one.

But isn't it odd that among all the diversity of mankind we do not encounter defective humans of this sort? Or are such people just to be found among the feeble-minded, only it is not closely enough observed which uses of language such people are capable of and which not?

Page Break 9

Page 9

44. "I had the intention of ..." does not express the memory of an experience. (Any more than "I was on the point of ...".)

Page 9

45. Intention is neither an emotion, a mood, nor yet a sensation or image. It is not a state of consciousness. It does not have genuine duration.

Page 9

46. "I have the intention of going away tomorrow."--When have you that intention? The whole time; or intermittently?

Page 9

47. Look in the drawer where you think you'll find it. The drawer is empty.--I believe you were looking for it among the sensations.

Page 9

Consider what it would really mean "to have an intention intermittently". It would mean: to have the intention, to abandon it, to resume it, and so on.

Page 9

48. In what circumstances does one say "This appliance is a brake, but it doesn't work"? That surely means: it does not fulfil its purpose. What is it for it to have this purpose? It might also be said: "It was the *intention* that this should work as a brake." Whose intention? Here intention as a state of mind entirely disappears from view.

Might it not even be imagined that several people had carried out an intention without any one of them having it? In this way a government may have an intention that no man has.

Page 9

49. There might be a verb which meant: to formulate an intention in words or other signs, out loud or in one's thoughts. This word would not mean the same as our "intend".

There might be a verb which meant: to act according to an intention; and neither would this word mean the same as our "intend".

Yet another might mean: to brood over an intention; or to turn it over and over in one's head.

Page 9

50. One may disturb someone in thinking-but in intending?--Certainly in planning. Also in keeping to an intention, that is in thinking or acting.

51. Application of the imperative. Compare these orders:

Raise your arm.
Imagine...
Work... out in your head
Consider...
Concentrate your attention on...
See this figure as a cube

with these:

Intend...
Mean... by these words
Suspect that this is the case
Believe that it is so
Be of the firm conviction...
Remember that this happened
Doubt whether it has happened
Hope for his return.

Is *this* the difference, that the first are voluntary, the second involuntary mental movements? I may rather say that the verbs of the second group do not stand for actions. (Compare with this the order: "Laugh heartily at this joke.")

52. Can one order someone to understand a sentence? Why can't one tell someone: "Understand that!" Couldn't I obey the order "Understand this Greek sentence" by learning Greek?--Similarly: one can say "Produce pain in yourself", but not "Have pain". One says "Bring yourself into this condition" but not "Be in this condition".

53. I expect an explosion any moment. I can't give my full attention to anything else; I look in a book, but without reading. Asked why I seem distracted or tense, I say I am expecting the explosion any moment.--Now how was it: did this sentence describe that behaviour? But then how is the process of expecting the explosion distinguished from the process of expecting some quite different event, e.g. a particular signal? And how is the expectation of *one* signal distinguished from the expectation of a slightly different one? Or was my behaviour only a side-effect of the real expectation, and was that a special mental process? And was this process homogeneous or articulated like a sentence (with an *internal* beginning and end)?--But how does

the person in whom it goes on know which event the process is the expectation of? For he does not seem to be in uncertainty about it. It is not as if he observed a mental or other condition and formed a conjecture about its cause. He may well say: "I don't know whether it is only this expectation that makes me so uneasy today"; but he will not say: "I don't know whether this state of mind, in which I now am, is the expectation of an explosion or of something else."

The statement "I am expecting a bang at any moment" is an *expression* of expectation. This verbal reaction is the movement of the pointer, which shows the object of expectation.

54. It seems as if the expectation and the fact satisfying the expectation fitted together somehow. Now one would like to describe an expectation and a fact which fit together, so as to see what this agreement consists in. Here one thinks at once of the fitting of a solid into a corresponding hollow. But when one wants to describe these two one sees that, to the extent that they fit, a *single* description holds for both. (On the other hand compare the meaning of: "These trousers don't go with this jacket".)

55. Like everything metaphysical the harmony between thought and reality is to be found in the grammar of the language.

56. Here my thought is: If someone could see the expectation itself--he would have to see *what* is being expected. (But in such a way that it doesn't further require a method of projection, a method of comparison, in order to pass from what he sees to the fact that is expected.)

But that's how it is: if you see the expression of expectation you see 'what is expected'.

57. The idea that it takes finding to show what we were looking for, and fulfilment of a wish to show what we wanted, means one is judging the process like the symptoms of expectation or search in someone else. I see him uneasily pacing up and down his room; then someone comes in at the door and he relaxes and gives signs of satisfaction. And I say "Obviously he was expecting this person".

Page Break 12

Page 12

58. We say that the expression of expectation describes the expected fact and think of this as of an object or complex which makes its appearance as fulfilment of the expectation.--But it is not the expected thing that is the fulfilment, but rather: its coming about.

The mistake is deeply rooted in our language: we say "I expect him" and "I expect his arrival", and "I expect he is coming".

Page 12

59. It is difficult for us to shake off this comparison: a man makes his appearance--an event makes its appearance. As if an event even now stood in readiness before the door of reality and were then to make its appearance in reality--like coming into a room.

Page 12

60. Reality is not a property still missing in what is expected and which accedes to it when one's expectation comes about.--Nor is reality like the daylight that things need to acquire colour, when they are already there, as it were colourless, in the dark.

Page 12

61. One may say of the bearer of a name that he does not exist; and of course that is not an activity, although one may compare it with one and say: he must be there all the same, if he does not exist. (And this has certainly already been written some time by a philosopher.)

Page 12

62. The shadowy anticipation of a fact consists in this: something is only *going* to happen, but we can think that *it* is going to happen. Or, as it misleadingly goes: we can now think *what* (or of what) is only *going* to happen.

Page 12

63. Some will perhaps want to say "An expectation is a thought". And we need to remember that the process of thinking may be *very various*.

Page 12

64. I whistle and someone asks me why I am so cheerful. I reply "I'm hoping N. will come today".--But while I whistled I wasn't thinking of him. All the same, it would be wrong to say: I stopped hoping when I began to whistle.

Page Break 13

Page 13

65. If I say "I am expecting...",--am I remarking that the situation, my actions, thoughts etc. are those of expectancy of this event; or are the words: "I am expecting..." part of the process of expecting?

In certain circumstances these words will mean (will be replaceable by) "I believe such-and-such will occur". Sometimes also: "Be prepared for this to happen...."

Page 13

66. Psychological--trivial--discussions about expectation, association etc. always pass over what is really noteworthy and it is noticeable that they talk around, without touching, the *punctum saliens*.†1

Page 13

67. An expectation is embedded in a situation from which it takes its rise. The expectation of an explosion for example, may arise from a situation in which an explosion is *to be expected*. The man who expects it had heard two people whispering: "Tomorrow at ten o'clock the fuse will be lit". Then he thinks: perhaps someone means to blow up a house here. Towards ten o'clock he becomes uneasy, jumps at every sound, and at last answers the question why he is so tense: "I'm expecting...". This answer will e.g. make his behaviour intelligible. It will enable us to fill out the picture of his thoughts and feelings.†2

Page 13

68. Fulfilment of expectation doesn't consist in this: a third thing happens which can be described otherwise than *as* "the fulfilment of this expectation", i.e. as a feeling of satisfaction or joy or whatever it may be. The expectation that something will be the case is the same as the expectation of the fulfilment of that expectation. [Marginal note: Expectation of what is not.]†3

Page 13

69. Socrates to Theaetetus: "If you have an idea, must it not be an idea of *something*?"--Theaetetus:

"Necessarily".--Socrates: "And if you have an idea of something mustn't it be of something real?"--Theaetetus: "It seems so".†4

If we put the word "kill", say, in place of "have an idea of" in this argument, then there is a rule for the use of this word: it makes no sense to say "I am killing something that does not exist". I can imagine a stag that is not there, in this meadow,

Page Break 14

but not kill one that is not there. And "to imagine a stag in this meadow" means to imagine *that* a stag is there. But to kill a stag does not mean to kill *that*.... But if someone says "In order for me to be able to imagine a stag it must after all exist in some sense",--the answer is: no, it does not have to exist in any sense. And if it should be replied: "But the colour brown at any rate must exist, for me to be able to have an idea of it"--then we can say: "The colour brown exists" means nothing at all; except that not it exists here or there as the colouring of an object, and that is necessary in order for me to be able to imagine a brown stag.

Page 14

70. Being able to do something seems like a shadow of the actual doing, just as the sense of a sentence seems like the shadow of a fact, or the understanding of an order the shadow of its execution. In the order the fact as it were "casts its shadow before". But this shadow, whatever it may be, is not the event.

Page 14

71. Compare the applications of:

"I have been in pain since yesterday"
"I have been expecting him since yesterday"
"I have known since yesterday"
"Since yesterday I've known how to integrate".

Page 14

72. The general differentiation of all states of consciousness from dispositions seems to me to be that one cannot ascertain by spotcheck whether they are still going on.

Page 14

73. Some sentences have to be read several times to be understood as sentences.

Page 14

74. A sentence is given me in code together with the key. Then of course in one way everything required for understanding the sentence has been given me. And yet I should answer the question "Do you understand this sentence?": No, not yet; I must first decode it. And only when e.g. I had translated it into English would I say "Now I understand it".

If now we raise the question "At what moment of translating do I *understand* the sentence?", we shall get a glimpse into the nature of what is called "understanding".

Page 14

75. I can attend to the course of my pains, but not in the same way to that of my belief, or my translation, or my knowledge.

Page Break 15

Page 15

76. One can observe the duration of a phenomenon by uninterrupted observation or by trials. The observation of duration may be continuous or intermittent.

Page 15

77. How do I observe my knowledge, my opinions? And on the other hand an after-image, a pain? Is there such a thing as uninterrupted observation of my capacity to carry out the multiplication...?

Page 15

78. Is "I hope..." a description of a state of mind? A state of mind has duration. So "I have been hoping for the whole day" is such a description; but suppose I say to someone: "I hope you come"--what if he asks me "For how long have you been hoping that?" Is the answer "For as long as I've been saying so"? Supposing I had some answer or other to that question, would it not be quite irrelevant to the purpose of the words "I hope you'll come"?

Page 15

79. We say "I hope you'll come", but not "I believe I hope you'll come", but we may well say: "I believe I still hope he'll come."

Page 15

80. What is the past tense of "You are coming, aren't you"?

Page 15

81. Where there is genuine duration one can tell someone: "Pay attention and give me a signal when the thing you are experiencing (the picture, the rattling etc.) alters."

Here there *is* such a thing as paying attention. Whereas one cannot follow with attention the forgetting of what one knew or the like. [Not right, for one also cannot follow one's own mental images with attention.]

Page 15

82. Think of this language-game: Determine how long an impression lasts by means of a stop-watch. The duration of knowledge, ability, understanding, could not be determined in this way.

Page 15

83. "But the difference between knowing and hearing surely doesn't reside simply in such a characteristic as the kind of duration they have. They are surely wholly and utterly distinct!" Of course. But one can't say: "*Know* and *hear*, and you will notice the difference".

Page Break 16

Page 16

84. "Pain is a state of consciousness, understanding is not."--"Well, the thing is, I don't *feel* my understanding."--But this explanation achieves nothing. Nor would it be any explanation to say: What one in some sense *feels* is a state of consciousness. For that would only mean: State of consciousness = feeling. (One word would merely have been replaced by another.)

Page 16

85. Really one hardly ever says that one has believed, understood, intended something "uninterruptedly" since yesterday. An interruption of belief would be a period of unbelief, not e.g. the withdrawal of attention from what one believes--e.g. sleep.

(Difference between 'knowing' and 'being aware of'.)

Page 16

86. The most important thing here is this: there is a difference; one notices the difference which is 'a category-difference'--without being able to say what it consists in. That is the case where it is usually said that we know the difference by introspection.

Page 16

87. This is likely to be the point at which it is said that only form, not content, can be communicated to *others*.--So one talks to oneself *about the content*!--(But how do my words 'relate' to the content I know? And to what purpose?)

Page 16

88. It is very noteworthy that *what goes on* in thinking practically never interests us. It is noteworthy, but not queer.

Page 16

89. ((Thoughts, as it were only hints.))†1

Isn't it the same here as with a calculating prodigy?--He has calculated right if he has got the right answer. Perhaps he himself cannot say what went on in him. And if we were to hear it, it would perhaps seem like a queer caricature of calculation.

Page 16

90. What do I know of what goes on within someone who is reading a sentence attentively? And can he describe it to me afterwards, and, if he does describe something, will it be *the* characteristic process of attention?

Page 16

91. Ask: What result am I aiming at when I tell someone: "Read attentively"? That, *e.g.*, this and that should strike him, and he be able to give an account of it.--Again, it could, I think, be said that if you read a sentence with attention you will often be able to

Page Break 17

give an account of what has gone on in your mind, e.g. the occurrence of images. But that does not mean that these things are what we call "attention".

Page 17

92. "Did you think as you read the sentence?"--"Yes, I did think as I read it; every word was important to me."

That is not the usual experience.†1 One is not usually half-astonished to hear oneself say something; one doesn't follow one's own talk with attention; for one ordinarily talks voluntarily, not involuntarily.

Page 17

93. If a normal human is holding a normal conversation under normal circumstances, and I were to be asked what

distinguishes thinking from not-thinking in such a case,--I should not know what answer to give. And I could *certainly not* say that the difference lay in something that goes on or fails to go on while he is speaking.

Page 17

94. The boundary-line that is drawn here between 'thinking' and 'not thinking' would run between two conditions which are not distinguished by anything in the least resembling a play of images. (For the play of images is admittedly the model according to which one would like to think of thinking.)

Page 17

95. Only under quite special circumstances does the question arise whether one spoke *thinkingly* or not.

Page 17

96. Sure, if we are to speak of an experience of thinking, the experience of speaking is as good as any. But the concept 'thinking' is not a concept of an experience. For we don't compare thoughts in the same way as we compare experiences.

Page 17

97. What one mimics is, say, a man's tone in speaking, his expression and similar things; and that suffices us. This proves that the important accompanying phenomena of talking are found *here*.

Page 17

98. Do we say that *anyone* who is speaking significantly is thinking? For example the builder in language-game no. 2?†2 Couldn't we imagine him building and calling out the words in surroundings in which we should not connect this even remotely with thinking?

Page Break 18

Page 18

99. (On language-game no. 2†1) "You are just tacitly assuming that these people *think*; that they are like people as we know them in *that* respect; that they do not carry on that language-game merely mechanically. For if you imagined them doing that, you yourself would not call it the use of a rudimentary language."

What am I to reply to this? Of course it is true that the life of those men must be like ours in many respects, and I said nothing about this similarity. But the important thing is that their language, and their thinking too, may be rudimentary, that there is such a thing as 'primitive thinking' which is to be described via primitive *behaviour*. The surroundings are not the 'thinking accompaniment' of speech.

Page 18

100. Let us imagine someone doing work that involves comparison, trial, choice. Say he is constructing an appliance out of various bits of stuff with a given set of tools. Every now and then there is the problem "Should I use *this* bit?"--The bit is rejected, another is tried. Bits are tentatively put together, then dismantled; he looks for one that fits etc., etc.. I now imagine that this whole procedure is filmed. The worker perhaps also produces sound-effects like "hm" or "ha!" As it were sounds of hesitation, sudden finding, decision, satisfaction, dissatisfaction. But he does not utter a single word. Those sound-effects may be included in the film. I have the film shewn me, and now I invent a soliloquy for the worker, things that fit his manner of work, its rhythm, his play of expression, his gestures and spontaneous noises; they correspond to all this. So I sometimes make him say "No, that bit is too long, perhaps another'll fit better." Or "What am I to do now?" "Got it!"-- Or "That's not bad" etc.

If the worker can talk--would it be a falsification of what actually goes on if he were to describe that precisely and were to say e.g. "Then I thought: no, that won't do, I must try it another way" and so on--although he had neither spoken during the work nor imagined these words?

I want to say: May he not later give his wordless thoughts in words? And in such a fashion that we, who might see the work in progress, could accept this account?--And all the more, if we had often watched the man working, not just once?

Page Break 19

Page 19

101. Of course we cannot separate his 'thinking' from his activity. For the thinking is not an accompaniment of the work, any more than of thoughtful speech.

Page 19

102. Were we to see creatures at work whose *rhythm* of work, play of expression etc. was like our own, but for their not *speaking*, perhaps in that case we should say that they thought, considered, made decisions. For there would be a great deal there corresponding to the action of ordinary humans. And there is no deciding how close the correspondence must be to give us the right to use the concept 'thinking' in their case too.

103. And anyhow what should we come to this decision for?

We shall be making an important distinction between creatures that can learn to do work, even complicated work, in a 'mechanical' way, and those that make trials and comparisons as they work.--But what should be called "making trials" and "comparisons" can in turn be explained only by giving examples, and these examples will be taken from our life or from a life that is like ours.

104. If he has made some combination in play or by accident and he now uses it as a method of doing this and that, we shall say he thinks.--In *considering* he would mentally review ways and means. But to do this he must already have some in stock. Thinking gives him the possibility of *perfecting* his methods. Or rather: He 'thinks' when, in a definite kind of way, he perfects a method he has. [*Marginal note*: What does the search look like?]

105. It could also be said that a man thinks when he *learns* in a particular way.

106. And this too could be said: Someone who *thinks* as he works will intersperse his work with *auxiliary activities*. The word "thinking" does not now mean these auxiliary activities, just as thinking is not talking either. Although the concept 'thinking' is formed on the model of a kind of imaginary auxiliary activity. (Just as we might say that the concept of the differential quotient is formed on the model of a kind of ideal quotient.)

107. These auxiliary activities are not the thinking; but one imagines thinking as the stream which must be flowing under the surface of these expedients, if they are not after all to be mere mechanical procedures.

108. Suppose it were a question of buying and selling creatures (anthropoid brutes) which we use as slaves. They cannot learn to talk, but the cleverer among them can be taught to do quite complicated work; and some of these creatures work 'thinkingly', others quite mechanically. For a thinking one we pay more than for one that is merely mechanically clever.

109. If there were only quite few people who could get the answer to a sum without speaking or writing, they could not be adduced as testimony to the fact that calculating can be done without signs. The reason is that it would not be clear that these people were 'calculating' at all. Equally Ballard's testimony (in James) cannot convince one that it is possible to think without a language.

Indeed, where no language is used, why should one speak of 'thinking'? If this is done, it shows something about the *concept* of thinking.

110. 'Thinking', a widely ramified concept. A concept that comprises many manifestations of life. The *phenomena* of thinking are widely scattered.

111. We are not at all *prepared* for the task of describing the use of e.g. the word "to think" (And why should we be? What is such a description useful for?)

And the naïve idea that one forms of it does not correspond to reality at all. We expect a smooth contour and what we get to see is ragged. Here it might really be said that we have constructed a false picture.

112. It is not to be expected of this word that it should have a unified employment; we should rather expect the opposite.

113. Where do we get the concept 'thinking' from which we want to consider here? From everyday language. What first fixes the direction of our attention is the word "thinking". But

the use of this word is confused. Nor can we expect anything else. And that can of course be said of all psychological verbs. Their employment is not so clear or so easy to get a synoptic view of, as that of terms in mechanics, for example.

114. One learns the word "think", i.e. its use, under certain circumstances, which, however, one does not learn to describe.

Page 21

115. But I *can teach* a person the use of the word! For a description of those circumstances is not needed for that.

Page 21

116. I just teach him the word *under particular circumstances*.

Page 21

117. We learn to say it perhaps only of human beings; we learn to assert or deny it of them. The question "Do fishes think?" need not exist among their applications of language, *it is not raised*. (What can be more natural than such a set-up, such a use of language?)

Page 21

118. "No one thought of *that case*"--we may say. Indeed, I cannot enumerate the conditions under which the word "to think" is to be used--but if a circumstance makes the use doubtful, I can say so, and also say *how* the situation is deviant from the usual ones.

Page 21

119. If I have learned to carry out a particular activity in a particular room (putting the room in order, say) and am master of this technique, it does not follow that I must be ready to describe the arrangement of the room; even if I should at once notice, and could also describe, any alteration in it.

Page 21

120. "This law was not given with such cases in view." Does that mean it is senseless?

Page 21

121. It could very well be imagined that someone knows his way around a city perfectly, i.e. would confidently find the shortest way from any place in it to any other,--and yet would be quite incompetent to draw a map of the city. That, as soon as he tries, he produces nothing that is not completely wrong. (Our concept of 'instinct'.)

Page Break 22

Page 22

122. Remember that our language might possess a variety of different words: one for 'thinking out loud'; one for thinking as one talks to oneself in the imagination; one for a pause during which something or other floats before the mind, after which, however, we are able to give a confident answer.

One word for a thought expressed in a sentence; one for the lightning thought which I may later 'clothe in words'; one for wordless thinking as one works.

Page 22

123. "Thinking is a mental activity"--Thinking is *not* a bodily activity. Is thinking an activity? Well, one may tell someone: "Think it over". But if someone in obeying this order talks to himself or even to someone else, does he then carry out *two* activities?

Page 22

124. Concern with what we say has its own specific signs. It also has its own specific consequences and preconditions. Concern is something experienced; we attribute it to ourselves, not on grounds of observation. It is not an accompaniment of what we say. What would make an accompaniment of a sentence into concern about the content of that sentence? (Logical condition.)

Page 22

125. Compare the phenomenon of thinking with the phenomenon of burning. May not burning, flame, seem mysterious to us? And why flame more than furniture?--And how do you clear up the mystery?

And how is the riddle of thinking to be solved?--Like that of flame?

Page 22

126. Isn't flame mysterious because it is impalpable? All right--but why does that make it mysterious? Why should something impalpable be more mysterious than something palpable? Unless it's because we *want* to catch hold of it.--

Page 22

127. The soul is said to *leave* the body. Then, in order to exclude any similarity to the body, any sort of idea that some gaseous thing is meant, the soul is said to be incorporeal, non-spatial; but with the word "leave" one has already said it all. Shew me *how* you use the word "spiritual" and I shall see whether the soul is non-corporeal and what you understand by "spirit".

Page Break 23

Page 23

128. I am inclined to speak of a lifeless thing as lacking something. I see life definitely as a plus, as something added to a lifeless thing. (Psychological atmosphere.)

129. We don't say of a table and a chair: "Now they are thinking," nor "Now they are not thinking," nor yet "They never think"; nor do we say it of plants either, nor of fishes; hardly of dogs; only of human beings. And not even of all human beings.

"A table doesn't think" is not assimilable to an expression like "a table doesn't grow". (I shouldn't know 'what it would be like if a table were to think.) And here there is obviously a gradual transition to the case of human beings.

130. We only speak of 'thinking' in quite particular circumstances.

131. How then can the sense and the truth (or the truth and the sense) of sentences collapse together? (Stand or fall together?)

132. And isn't it as if you wanted to say: "If such-and-such is not the case, then it makes no *sense* to say it is the case"?

133. Like this, e.g.: "If all moves were *always* false, it would make no sense to speak of a 'false move'." But that is only a paradoxical way of putting it. The nonparadoxical way would be: "The general description ... makes no sense".

134. Do not say "one cannot", but say instead: "it doesn't exist in this game". Not: "one can't castle in draughts" but--"there is no castling in draughts"; and instead of "I can't exhibit my sensation"--"in the use of the word 'sensation', there is no such thing as exhibiting what one has got"; instead of "one cannot enumerate all the cardinal numbers"--"there is no such thing here as enumerating all the members".

135. Conversation flows on, the application and interpretation of words, and only in its course do words have their meaning.

"He has gone away" "Why?"--What did you mean, when you uttered the word "why"? What did you *think* of?

136. Think of putting your hand up in school. Need you have rehearsed the answer silently to yourself, in order to have the right to put your hand up? And *what* must have gone on inside you?--Nothing need have. But it is important that you usually know an answer when you put your hand up; and that is the criterion for one's *understanding* of putting one's hand up.

Nothing need have gone on in you; and yet you would be remarkable if on such occasions you never had anything to report about what went on in you.

137. Sometimes when I say "Just then I had the thought...." I may report that I had said those very words to myself, out loud or silently; or if not those, then others of which the present ones reproduce the gist. Surely that often happens. But it does also happen that my present words are 'not a *reproduction*', for they are only a reproduction if they are so by rules of projection.

138. It looks as if a sentence with e.g. the word "ball" in it already contained the shadow of other uses of this word. That is to say, the *possibility* of forming those other sentences.--To whom does it look like that? And under what circumstances?

139. We don't get free of the idea that the sense of a sentence accompanies the sentence: is there alongside of it.

140. One wants to say e.g.: "The one negation *does* the same thing with the proposition as the other, it excludes what it describes." But that is only another way of expressing one's assimilation of the two negative propositions. (Which is valid only when the negated proposition is not itself a negative proposition.) Ever and again comes the thought that what we see of a sign is only the outside of something within, in which the real operations of sense and meaning go on.†1

141. Our problem could be (very clearly) formulated like this: suppose we had two systems for measuring length; in

both a length is expressed by a numeral which is followed by a word giving the unit. One system designates a length as "n ft", and a foot is a unit of length in the ordinary sense; in the other system a length is designated by "n W" and $1 \text{ ft} = 1 \text{ W}$. But $2 \text{ W} = 4 \text{ ft}$,

Page Break 25

$3 \text{ W} = 9 \text{ ft}$ and so on.--So the sentence "This stick is 1 W long" means the same as "This stick is 1 ft long". Question: have "W" and "ft" the same meaning in these two sentences?

Page 25

142. The question is wrongly framed. We can see this, if we express the identity of meaning by an equation. The question can only run: "Does $\text{W} = \text{ft}$ or not?"--The sentences in which these signs occur do not come in here.--No more, of course, can we ask in this terminology whether "is" in one place means the same as "is" in another; what we can ask is whether the copula means the same as the equals sign. Well, what we said was: $1 \text{ ft} = 1 \text{ W}$; but $\text{ft} \neq \text{W}$.

Page 25

143. We might say: in all cases what one means by "thought" is what is *alive* in the sentence. That without which it is dead, a mere sequence of sounds or written shapes.

If however I were to speak in the same way of a something that gives meaning to a configuration of chess pieces, that is to say distinguishes them from any old arrangement of little bits of wood--couldn't I mean all sorts of things? The rules that make the chess arrangement into a situation in a game; the special experiences that we associate with such positions in a game; the usefulness of the game.

Or suppose we were to speak of a something that distinguishes paper money from mere printed slips of paper and gives it its meaning, its life!

Page 25

144. How words are understood is not told by words alone. (Theology.)

Page 25

145. There could also be a language in whose use the impression made on us by the signs played no part; in which there was no such thing as understanding, in the sense of such an impression. The signs are e.g. written and transmitted to us, and we are able to *take notice of them*. (That is to say, the only impression that comes in here is the pattern of the sign.) If the sign is an order, we translate it into action by means of rules, tables. It does not get as far as an impression, like that of a picture; nor are stories written in this language.

Page 25

146. In this case one might say: "Only in the system has the sign any life."

Page Break 26

Page 26

147. We could of course also imagine that we had to use rules, and translate a verbal sentence into a drawing in order to get an *impression* from it. (That only the picture had a soul.)

Page 26

148. We could imagine a language in which the meanings of expressions changed according to definite rules, e.g.: in the morning the expression A means this, in the afternoon it means that.

Or a language in which the individual words altered every day; each day each letter of the previous day would be replaced by the next one in the alphabet (and z by a).

Page 26

149. Imagine the following language: its vocabulary and grammar are those of English, but the words occur in the sentences in reverse order. So a sentence of this language sounds like an English sentence read from the full stop back to the beginning. Thus the possibilities of expression have the same multiplicity as in English. But the familiar ring of our sentences is done away with.

Page 26

150. Someone who doesn't know English hears me say on certain occasions: "What marvellous light!" He guesses the sense and now uses the exclamation himself, as I use it, but without understanding the three individual words. Does he understand the exclamation?

Page 26

151. I intentionally chose an example in which a man gives expression to his sensation. For in this case sounds belonging to no language are said to be full of meaning.

Page 26

152. Would it be equally easy to imagine the analogous case for this sentence: "If the train does not arrive punctually at five o'clock, he'll miss the connexion"? What would guessing the sense mean in this case?

153. It somehow worries us that the thought in a sentence is not wholly present at any one moment. We regard it as an object which we are making and have never got all there, for no sooner does one part appear than another vanishes.

154. (On no. 150) A language may easily be imagined in which people use a single word for the exclamation. But what about one word for the sentence "If the train...."? In what kind of case should we say that the word actually stood for that sentence?

Say in this one: people begin by using a sentence like ours, but then circumstances arise in which the sentence has to be uttered so often that they contract it to a single word. So these people could still explain the word by means of the sentence.

But is the further case possible in which people possess *only* a single word with that sense, that is for that use? Why not? One needs to imagine how the use of this word is learnt, and in what circumstances we should say that the word really stands in place of that sentence.

But remember this: in our language someone says "He is arriving at five o'clock"; someone else replies "No, at ten past five". Is there also this sort of exchange in the other language?

That is why sense and reference are vague concepts.

155. A poet's words can pierce us. And that is of course *causally* connected with the use that they have in our life. And it is also connected with the way in which, conformably to this use, we let our thoughts roam up and down in the familiar surroundings of the words.

156. Is there *a* difference of meaning that can be explained and another that does not come out in an explanation?

157. Soulful expression in music--this cannot be recognized by rules. Why can't we imagine that it might be, by other beings?

158. If a theme, a phrase, suddenly means something to you, you don't have to be able to explain it. Just *this* gesture has been made accessible to you.

159. But you do speak of *understanding* music. You understand it, surely, *while* you hear it! Ought we to say this is an experience which accompanies the hearing?

160. The way music speaks. Do not forget that a poem, even though it is composed in the language of information, is not used in the language-game of giving information.

161. Mightn't we imagine a man who, never having had any acquaintance with music, comes to us and hears someone playing a reflective piece of Chopin and is convinced that this is a language and people merely want to keep the meaning secret from him?

There is a strongly musical element in verbal language. (A sigh, the intonation of voice in a question, in an announcement, in longing; all the innumerable *gestures* made with the voice.)

162. But if I hear a tune with understanding, doesn't something special go on in me--which does not go on if I hear it without understanding? And *what?*--No answer comes; or anything that occurs to me is insipid. I may indeed say: "Now I've understood it," and perhaps talk about it, play it, compare it with others etc. *Signs* of understanding may accompany hearing.

163. It is wrong to call understanding a process that accompanies hearing. (Of course its manifestation, expressive playing, cannot be called an accompaniment of hearing either.)

164. For how can it be explained what 'expressive playing' is? Certainly not by anything that accompanies the playing.--What is needed for the explanation? One might say: a culture.--If someone is brought up in a particular culture--and then reacts to music in such-and-such a way, you can teach him the use of the phrase "expressive

playing".

Page 28

165. The understanding of music is neither sensation nor a sum of sensations. Nevertheless it is correct to call it an experience inasmuch as *this* concept of understanding has some kinship with other concepts of experience. You say "I experienced that passage quite differently". But still this expression tells you '*what happened*' only if you are at home in the special conceptual world that belongs to these situations. (Analogy: "I won the match".)

Page 28

166. *This* floats before my mind as I read. So does something go on in reading...?--This question doesn't get us anywhere.

Page 28

167. But how can it float before me?--Not in the dimensions you are thinking of.

Page Break 29

Page 29

168. How do I know that someone is enchanted? How does one learn the linguistic expression of enchantment? What does it connect up with? With the expression of bodily sensations? Do we ask someone what he feels in his breast and facial muscles in order to find out whether he is feeling enjoyment?

Page 29

169. But does that mean that there are not sensations which often return when one is enjoying music? Certainly not.

Page 29

170. A poem makes an impression on us as we read it. "Do you feel the same while you read it as when you read something indifferent?"--How have I learnt to answer this question? Perhaps I shall say "Of course not!"--which is as much as to say: *this* takes hold of me, and the other not.

"I experience something different"--And what kind of thing?--I can give no satisfactory answer. For the answer I give is not in itself of any importance.--"But didn't you enjoy it *during* the reading?" Of course--for the opposite answer would mean: I enjoyed it earlier or later, and I don't want to say that.

But now, surely you remember sensations and images as you read, and they are such as to connect up with the enjoyment, with the impression.--But they got their significance only from the surroundings: through the reading of this poem, from my *familiarity* with its language, with its metre and with innumerable associations.

You must ask how we learnt the expression "Isn't that glorious!" at all.--No one explained it to us by referring to sensations, images or thoughts that accompany hearing! Nor should we doubt whether he had enjoyed it if he had no account to give of such experiences; though we should, if he shewed that he did not understand certain tie-ups.

Page 29

171. But isn't understanding shewn e.g. in the expression with which someone reads the poem, sings the tune? Certainly. But what is the experience during the reading? About that you would just have to say: you enjoy and understand it if you hear it well read, or feel it well read in your speech-organs.

Page 29

172. Understanding a musical phrase may also be called understanding a *language*.

Page Break 30

Page 30

173. I think of a quite short phrase, consisting of only two bars. You say "What a lot that's got in it!" But it is only, so to speak, an optical illusion if you think that what is there goes on as we hear it. ("It all depends *who* says it.") (Only in the stream of thought and life do words have meaning.)

Page 30

174. What contains the illusion is not *this*: "Now I've understood"--followed perhaps by a long explanation of what I have understood.

Page 30

175. Doesn't the theme point to anything outside itself? Yes, it does! But that means:--it makes an impression on me which is connected with things in its surroundings--e.g. with our language and its intonations; and hence with the whole field of our language-games.

If I say for example: Here it's as if a conclusion were being drawn, here as if something were being confirmed, *this* is like an answer to what was said before,-then my understanding presupposes a familiarity with inferences, with confirmation, with answers.

Page 30

176. The words "Gottlob! Noch etwas Weniges hat man geflüchtet--vor den Fingern der Kroaten,"†1 and the tone

and glance that go with them seem indeed to carry within themselves every last *nuance* of the meaning they have. But only because we know them as part of a particular scene. But it would be possible to construct an entirely different scene around these words so as to shew that the special spirit they have resides in the story in which they come.

Page 30

177. If I hear someone say: "Away!" with a gesture of repulsion, do I have an 'experience' of meaning *here* as I do in the game where I pronounce that to myself meaning it now in one sense, now in another?--For he could also have said "Get away from me!" and then perhaps I'd have experienced the whole phrase in such-and-such a way--but the single word? Perhaps it was the supplementary words that made the impression on me.

Page Break 31

Page 31

178. The peculiar experience of meaning is characterized by the fact that we come out with an explanation and use the past tense: just as if we were explaining the meaning of a word for practical purposes.

Page 31

179. *Forget*, forget that you have these experiences yourself!

Page 31

180. How could he hear the word with that meaning? How was it possible?! It just wasn't--not in *these* dimensions.--

Page 31

181. But isn't it true, then, that the word means that to me now? Why not? For this sense doesn't come into conflict with the rest of the use of the word.

Someone says: "Give him the news that..., and *mean* by it..."--What sense would this order make?

Page 31

182. "When I uttered the word just now, it meant... to me." Why should that not be mere lunacy? Because *I* experienced that? That is not a reason.

Page 31

183. The man I call meaning-blind will understand the instruction "Tell him he is to go to the bank--I mean the river bank," but not "Say the word bank and mean the bank of a river". What concerns this investigation is not the forms of mental defect that are found among men; but the possibility of such forms. We are interested, not in whether there are men incapable of a thought of the type: "I was then going to..."--but in how the concept of such a defect should be worked out.

If you assume that someone cannot do *this*, how about *that*? Are you supposing he can't do that either?--Where does this concept take us? For what we have here are of course paradigms.

Page 31

184. Different people are very different in their sensitiveness about changes in the orthography of a word. And the feeling is not just piety towards an old use.--If for you spelling is just a practical question, the feeling you are lacking in is not unlike the one that a 'meaning-blind' man would lack. (Goethe on people's names. Prisoners' numbers.)

Page 31

185. It's just like the way some people do not understand the question "What colour has the vowel *a* for you?"--If someone did not understand this, if he were to declare it was nonsense--

Page Break 32

could we say he did not understand English, or the meaning of the individual words "colour", "vowel" etc.?

On the contrary: Once he has learned to understand these words, then it is possible for him to react to such questions 'with understanding' or 'without understanding'.

Page 32

186. Misunderstanding-non-understanding. Understanding is effected by explanation; but also by training.

Page 32

187. Why can't a cat be taught to retrieve? Doesn't it understand what one wants? And what constitutes understanding or failure to understand here?

Page 32

188. "I read each word with the feeling appropriate to it. The word 'but' e.g. with the but-feeling--and so on."--And even if that is true--what does it really signify? What is the logic of the concept 'but-feeling'?--It certainly isn't a feeling just because I call it "a feeling".

Page 32

189. Is lying a particular experience? Well, can I tell someone "I am going to tell you a lie" and straightway do it?

190. To what extent am I aware of lying while I'm telling a lie? Just in so far as I don't 'only realise it later on', and all the same I do know later that I was lying. The awareness that one is lying is a knowing-how. It is no contradiction of this that there are characteristic feelings of lying. [*Marginal note: Intention.*]

191. Knowledge is not *translated* into words when it is expressed. The words are not a translation of something else that was there before they were.

192. "To purpose to do something is a special inner process."--But what sort of process--even if you could dream one up could satisfy our requirements about purpose?

193. Isn't it just like this with the verb "to understand"? Someone tells me the route I have to take to some place and from there on. He asks "Did you understand?" I reply "Yes I did". --Do I mean to tell him what was going on within me during his explanation?--And after all that could be told him too.

194. Imagine the following game: A list of words from various languages and of senseless sound-sequences is read out to me. I am to say after each whether I understand it or not; and also what went on within me as I understood or failed to understand.--At the word "tree" I shall answer "yes" without reflection (perhaps an image floats before my mind); at a collocation of sounds that I have never heard before, I answer "No" equally without reflection. At words which stand for particular shades of colour, the answer will often be preceded by an image, at a few words ("continuum," say) there will be consideration; at words like the article "the" perhaps a shrug of the shoulders; words of a foreign language I shall *sometimes* translate into English; when images rise in my mind they are sometimes images of the objects that are designated by the words (in turn a host of cases), sometimes different pictures.

This game might be supplemented by one in which someone calls out the names of *activities* and at each one asks: "Can you do that?"--The subject is to give his reasons for answering the question "yes" or "no".

195. Let us imagine a kind of puzzle picture: there is not *one* particular object to find; at first glance it appears to us as a jumble of meaningless lines, and only after some effort do we see it as, say, a picture of a landscape.--What makes the difference between the look of the picture before and after the solution? It is clear that we see it differently the two times. But what does it amount to to say that after the solution the picture means something to us, whereas it meant nothing before?

196. We can also put this question like this: What is the general mark of the solution's having been found?

197. I will assume that as soon as it is solved I make the solution obvious by strongly tracing certain lines in the picture and perhaps putting in some shadows. Why do you call the picture you have sketched in a solution?

- (a) Because it is the clear representation of a group of spatial objects.
- (b) Because it is the representation of a regular solid.
- (c) Because it is a symmetrical figure.

- (d) Because it is a shape that makes an ornamental impression on me.
- (e) Because it is the representation of a body I am familiar with.
- (f) Because there is a list of solutions and this shape (this body) is on the list.
- (g) Because it represents a kind of object that I am very familiar with; for it gives me an instantaneous impression of familiarity, I instantly have all sorts of associations in connexion with it; I know what it is called; I know I have often seen it; I know what it is used for etc.
- (h) Because I seem to be familiar with the object, a word occurs to me at once as its name (although the word does not belong to any existent language); I tell myself "Of course that's a..." and give myself a nonsensical explanation, which at that moment seems to me to make sense. (Like in a dream.)
- (i) Because it represents a face which strikes me as familiar.
- (j) Because it represents a face which I recognize; it is the face of my friend N; it is a face which I have often seen pictures of, etc.
- (k) Because it represents an object which I remember having seen at some time.

- (l) Because it is an ornament that I know well (though I don't remember where I have seen it).
 - (m) Because it is an ornament that I know well; I know its name, I know where I have seen it.
 - (n) Because it represents part of the furniture of my room.
 - (o) Because I instinctively traced out those lines and now feel easy.
 - (p) Because I remember that this object has been described to me. And so on.
- (Anyone who does not understand why we talk about these things must feel what we say to be mere trifling.)

Page 34

198. Can I think away the impression of familiarity where it exists; and think it into a situation where it does not? And what does that mean? I see e.g. the face of a friend and ask myself: What does this face look like if I see it as a strange face (as if I were seeing it now for the first time)? What remains, as it were,

Page Break 35

of the look of this face, if I think away, subtract, the impression of familiarity from it? Here I am inclined to say: "It is *very difficult* to separate the familiarity from the impression of the face". But I also feel that this is a bad way of putting things. For I have no notion how I should so much as *try* to separate these two things. The expression "to separate them" does not have any clear sense for me.

I know what *this means*: "Imagine this table black instead of brown". To this there corresponds: "Paint this table, but black instead of brown".

Page 35

199. Suppose someone were to say: "Imagine this butterfly exactly as it is, but ugly instead of beautiful"?!

Page 35

200. In this case *we* have not *determined* what thinking the familiarity away is to mean.

It might mean, say, to recall the impression which I had when I saw the face for the first time.

Page 35

201. For someone who has no knowledge of such things a diagram representing the inside of a radio receiver will be a jumble of meaningless lines. But if he is acquainted with the apparatus and its function, that drawing will be a significant picture for him.

Given some solid figure (say in a picture) that means nothing to me at present--can I at will imagine it as meaningful? That's as if I were asked: Can I imagine an object of any old shape as an appliance? But to be applied to what?

One class of corporeal shapes might readily be imagined as dwellings for beasts or men. Another class as weapons. Another as models of landscapes. Etc. etc. So here I know how I can ascribe meaning to a meaningless shape.

Page 35

202. Consider well how we use the word "recognize". I recognize the furniture in my room, my friend whom I see every day. But no 'act of recognition takes place'.

Page 35

203. Someone might say: I should have no impression of the room as a whole, if I could not let my glance roam rapidly to and fro in it and myself move about in it freely. (Stream of thought.) But now the question is: How is it manifested that I 'have an

Page Break 36

impression of the room as a whole'? For one thing, in its being a matter of course that I find my way around in it; in the absence of hunting about, hesitation, and surprise. In there being no end of activities that are encompassed by its walls and in all this being covered by the expression "my room" when I'm talking. In my finding it useful and necessary to keep on using the idea 'my room', as opposed to its walls, its corners etc.

Page 36

204. What is the description of an 'attitude' like?

One says e.g. "Disregard these spots and this little irregularity, and look at it as a picture of a...."

"Think *that* away. Would you dislike the thing even without this...." Of course it will be said that I alter my visual image--as by blinking or blocking out a detail. This "Disregarding..." does indeed play a part quite like, say, the production of a new picture.

Page 36

205. Very well--that is good reason to say that we altered our visual impression through our attitude. That is to say, there are good reasons to delimit the concept 'visual impression' in this way.

Page 36

206. "But in seeing I can obviously *take elements together* (lines for example)." But why does one call it "taking

together"? Why does one here--*essentially*--need a word that already has another meaning? (This is of course like the case of the phrase "*calculating* in one's head".)

Page 36

207. If I tell someone "Take these lines (or something else) together" what will he do? Well, various things, according to the circumstances. Perhaps he is supposed to count them two by two, or to put them in a drawer, or to look at them etc.

Page 36

208. Let us consider what is said about a phenomenon like this:

Seeing the figure &unk; now as an F, now as the mirror image of an F.

I want to ask: what constitutes seeing the figure now like this, now another way?--Do I really see something different every time? Or do I merely *interpret* what I see in a different way?--I am inclined to say the first. *But why?* Well, interpreting is a procedure. It may for example consist in somebody's saying

Page Break 37

"That is supposed to be an F"; or not saying it, but replacing the sign with an F in copying; or again considering: "What can that be? It'll be an F that the writer did not hit off."--Seeing is not an action but a state. (A grammatical remark.) And if I have never read the figure as anything but an F, or considered what it might be, we shall say that I *see* it as F; if, that is, we know that it can also be seen differently. I should call it "interpretation" if I were to say "That is certainly supposed to be an F; the writer does all his F's like that."

Page 37

For how do we arrive at the concept 'seeing this as that' at all? On what occasions does it get formed, when is there need of it? (Very frequently in art.) Where, for example, there is a question of phrasing by eye or ear. We say "You have to hear these bars as an introduction," "You must hear it as in this key." "Once you have seen this figure as... it is difficult to see it otherwise", "I hear the French 'ne ... pas' as a negation in two parts, not as 'not a step'" etc., etc. Now, is it a real case of seeing or hearing? Well, we call it that; we react with these words in particular situations. And we react *to* these words in turn by particular actions.

209. This shape that I see--I want to say--is not simply *a* shape; it is one of the shapes I know; it is a shape marked out in advance. It is one of those shapes of which I already had a pattern in me; and only because it corresponds to such a pattern is it this familiar shape. (I as it were carry a catalogue of such shapes around with me, and the objects portrayed in it *are* the familiar ones.)

Page 37

210. But my already carrying the pattern around with me would be only a causal explanation of the present impression. It is like saying: this movement is made as easily as if it had been practised.

Page 37

211. "When I am asked 'Do you see a ball over there' and another time 'Do you see half a ball over there?' what I see may be the same both times, and if I answer 'Yes', still I distinguish between the two hypotheses. As I distinguish between pawn and king in chess, even if the present move is one that either might make, and even if an actual king-piece were being

Page Break 38

used as a pawn."--In philosophy one is in constant danger of producing a myth of symbolism, or a myth of mental processes. Instead of simply saying what anyone knows and must admit.

Page 38

212. Does introspection tell me whether what I have here is a genuine case of seeing, or one of interpretation after all? First of all I must make dear to myself what I should call an interpretation; how to tell whether something is to be called a case of interpreting or of seeing. [*Marginal note:* Seeing according to an interpretation.]

Page 38

213. Don't I see the figure now like this, now another way, even when I do not react verbally or otherwise?

But "now like this" "now another way" are words, and what right have I to use them here? Can I shew my right to you or to myself? (Unless by a further reaction.)

But I surely know that they are two impressions, even if I don't say so. [*Marginal note:* But how do I know that what I say is what I knew? What consequences follow from my interpreting this as that, or from my seeing this as that?]

Page 38

214. Experience of the real size. We see a picture showing a chair-shape; we are told it represents a construction the size of a house. Now we see it differently.

Page 38

215. Imagine someone watching the sun and suddenly having the *feeling* that it is not the sun that moves--but we that move past it. Now he wants to say he has seen a new state of motion that we are in; imagine him showing by gestures which movement he means, and that it is not the sun's movement.--We should here be dealing with two different applications of the word "movement".

Page 38

216. We see, not change of aspect, but change of interpretation.

Page 38

217. You see it conformably, not to an interpretation, but to an act of interpreting.

Page 38

218. I interpret words; yes--but do I also interpret looks? Do I interpret a facial expression as threatening or kind?--That *may* happen.

Page Break 39

Page 39

Suppose I said: "It is not enough to perceive the threatening face, I have to interpret it."--Someone whips out a knife at me and I say "I conceive that as a threat."

Page 39

219. We don't understand Chinese gestures any more than Chinese sentences.

Page 39

220. Consciousness in another's face. Look into someone else's face, and see the consciousness in it, and a particular *shade* of consciousness. You see on it, in it, joy, indifference, interest, excitement, torpor and so on. The light in other people's faces.

Do you look into *yourself* in order to recognize the fury in *his* face? It is there as clearly as in your own breast.

(And what do we want to say now? That someone else's face stimulates me to imitate it, and that I therefore feel little movements and muscle-contractions in my own face and *mean* the sum of these? Nonsense. Nonsense,--because you are making assumptions instead of simply describing. If your head is haunted by explanations here, you are neglecting to remind yourself of the most important facts.)

Page 39

221. "Consciousness is as clear in his face and behaviour, as in myself."

Page 39

222. We do not see the human eye as a receiver, it appears not to let anything in, but to send something out. The ear receives; the eye looks. (It casts glances, it flashes, radiates, gleams.) One can terrify with one's eyes, not with one's ear or nose. When you see the eye you see something going out from it. You see the look in the eye.

Page 39

223. "If you only shake free from your physiological prejudices, you will find nothing queer about the fact that the glance of the eye can be seen too." For I also say that I see the look that you cast at someone else. And if someone wanted to correct me and say that I don't really *see* it, I should take that for pure stupidity.

On the other hand I have not *made any admissions* by using that manner of speaking, and I should contradict anyone who told me I saw the glance 'just the way' I see the shape and colour of the eye.

For 'naïve language', that is to say our naïve, normal way of expressing ourselves, does not contain any theory of seeing--does not show you a *theory* but only a *concept* of seeing.

Page Break 40

Page 40

224. Get a human being to give angry, proud, ironical looks; and now veil the face so that only the eyes remain uncovered--in which the whole expression seemed concentrated: their expression is now surprisingly *ambiguous*.

Page 40

225. "We *see* emotion."--As opposed to what?--We do not see facial contortions and make inferences from them (like a doctor framing a diagnosis) to joy, grief, boredom. We describe a face immediately as sad, radiant, bored, even when we are unable to give any other description of the features.--Grief, one would like to say, is personified in the face.

This belongs to the concept of emotion.

Page 40

226. (The ugliness of a human being can repel in a picture, in a painting, as in reality, but so it can too in a description, in words.)

Page 40

227. How curious: we should like to explain our understanding of a gesture by means of a translation into words, and the understanding of words by translating them into a gesture. (Thus we are tossed to and fro when we try to find out where understanding properly resides.)

And we really shall be explaining words by a gesture, and a gesture by words.

Page 40

228. Explain to someone that the position of the clock-hands that you have just noted down is supposed to mean: the hands of this clock are now in this position.--The awkwardness of the sign in getting its meaning across, like a dumb person who uses all sorts of suggestive gestures--this disappears when we know that it all depends on the *system* to which the sign belongs.

We wanted to say: only the *thought* can say it, not the sign.

Page 40

229. But an *interpretation* is something that is given in signs. It is this interpretation as opposed to a different one (running differently).--So when we wanted to say "Any sentence still stands in need of an interpretation", that meant: no sentence can be understood without a rider.

Page 40

230. It would almost be like settling how much a toss is to be worth by another toss.

Page Break 41

Page 41

231. By "intention" I mean here what uses a sign in a thought. The intention seems to interpret, to give the final interpretation; which is not a further sign or picture, but something else--the thing that cannot be further interpreted. But what we have reached is a psychological, not a logical terminus.

Think of a sign language, an 'abstract' one, I mean one that is strange to us, in which we do not feel at home, in which, as we should say, we do not *think*; and let us imagine this language interpreted by a translation into--as we should like to say--an unambiguous picture-language, a language consisting of pictures painted in perspective. It is quite clear that it is much easier to imagine different *interpretations* of the written language than of a picture painted in the usual way. Here we shall also be inclined to think that there is no further possibility of interpretation.

Page 41

232. Here we might also say we didn't enter into the sign-language, but did enter into the painted picture.

Page 41

233. "Only the intended picture reaches up to reality like a yardstick. Looked at from outside, there it is, lifeless and isolated."--It is as if at first we looked at a picture so as to enter into it and the objects in it surrounded us like real ones; and then we stepped back, and were now outside it; we saw the frame, and the picture was a painted surface. In this way, when we intend, we are surrounded by our intention's pictures, and we are inside them. But when we step outside intention, they are mere patches on a canvas, without life and of no interest to us. When we intend, we exist in the space of intention, among the pictures (shadows) of intention, as well as with real things. Let us imagine we are sitting in a darkened cinema and entering into the film. Now the lights are turned on, though the film continues on the screen. But suddenly we are outside it and see it as movements of light and dark patches on a screen.

(In dreams it sometimes happens that we first read a story and then are ourselves participants in it. And after waking up after a dream it is sometimes as if we had stepped back out of the dream and now see it before us as an alien picture.) And it also means something to speak of "living in the pages of a book."

Page Break 42

Page 42

234. What happens is not that this symbol cannot be further interpreted, but: I do not interpret. I do not interpret, because I feel at home in the present picture. When I interpret, I step from one level of thought to another.

Page 42

235. If I see the thought symbol 'from outside', I become conscious that it *could* be interpreted thus or thus; if it is a step in the course of my thoughts, then it is a stopping-place that is natural to me, and its further interpretability does not occupy (or trouble) me. As I have a time-table and use it without being concerned with the fact that a table is susceptible of various interpretations.

Page 42

236. If I try to describe the process of intention, I feel first and foremost that it can do what it is supposed to only by containing an extremely faithful picture of what it intends. But further, that that too does not go far enough, because a picture, whatever it may be, can be variously interpreted; hence this picture too in its turn stands isolated. When one has the picture in view by itself it is suddenly dead, and it is as if something had been taken away from it, which

had given it life before. It is not a thought, not an intention; whatever accompaniments we imagine for it, articulate or inarticulate processes, or any feeling whatsoever, it remains isolated, it does not point outside itself to a reality beyond.

Now one says: "Of course it is not the picture that intends, but we who use it to intend something." But if this intending, this meaning, is in turn something that is done with the picture, then I cannot see why that has to involve a human being. The process of digestion can also be studied as a chemical process, independently of whether it takes place in a living being. We want to say "Meaning is surely essentially a mental process, a process of conscious life, not of dead matter." But what will give such a thing the specific character of what goes on?--so long as we think of it as a process. And now it seems to us as if intending could not be any process at all, of any kind whatever.--For what we are dissatisfied with here is the grammar of *process*, not the specific kind of process.--It could be said: we should call any process "dead" in this sense.

Page Break 43

Page 43

237. It might almost be said: "Meaning *moves*, whereas a process stands still."

Page 43

238. One says: How can these gestures, this way of holding the hand, this picture, be the wish that such and such were the case? It is nothing more than a hand over a table and there it is, alone and without a *sense*. Like a single bit of scenery from the production of a play, which has been left by itself in a room. It had life only in the play.

Page 43

239. "At that moment the thought was before my mind."--And how?--"I had this picture."--So was the picture the thought? No; for if I had just told someone the picture, he would not have got the thought.

Page 43

240. The picture was the key. Or it *seemed* like a key.

Page 43

241. Let us imagine a picture story in schematic pictures, and thus more like the narrative in a language than a series of realistic pictures. Using such a picture-language we might in particular e.g. keep our hold on the course of battles. (Language-game.) And a sentence of our word-language approximates to a picture in this picture language much more closely than we think.

Page 43

242. Let us remember too that we don't have to translate such pictures into realistic ones in order to 'understand' them, any more than we ever translate photographs or film pictures into coloured pictures, although black-and-white men or plants in reality would strike us as unspeakably strange and frightful.

Suppose we were to say at this point: "Something is a picture only in a picture-language"?

Page 43

243. Certainly I read a story and don't give a hang about any system of language. I simply read, have impressions, see pictures in my mind's eye, etc.. I make the story pass before me like pictures, like a cartoon story. (Of course I do not mean by this that every sentence summons up one or more visual images, and that that is, say, the purpose of a sentence.)

Page 43

244. "Sentences serve to describe how things are", we think. The sentence as a *picture*.

Page Break 44

Page 44

245. I understand the picture exactly, I could model it in clay.--I understand this description exactly, I could make a drawing from it.

In many cases we might set it up as a criterion of understanding, that one had to be able to represent the sense of a sentence in a drawing (I am thinking of an officially instituted test of understanding). How is one examined in map-reading, for example?

Page 44

246. And the significant picture is what can not merely be drawn, but also represented plastically. And saying this would make sense. But the thinking of a sentence is not an activity which one does from the words (like, say, singing from the notes). The following example shews this. Does it make sense to say "I have as many friends as the number yielded by a solution of the equation... "? One can't immediately see whether this makes sense, from the equation. And so while one is reading the sentence one doesn't know whether or not it can be thought. Whether or not it can be understood.

Page 44

247. For what does it mean "to discover that a sentence does not make sense"?

And what does this mean: "if I mean something by it, surely it must make sense"?

The first presumably means: not to be misled by the appearance of a sentence and to investigate its application in the language-game.

And "if I mean something by it"--does that mean something *like*: "if I can imagine something in connexion with it"?--An image often leads on to a further application.

Page 44

248. (Something that at first sight looks like a sentence and is not one.) The following design for the construction of a steamroller. The motor is in the inside of the hollow roller. The crank-shaft runs through the middle of the roller and is connected at both ends by spokes with the wall of the roller. The cylinder of the motor is fixed onto the inside of the roller. At first glance this construction looks like a machine. But it is a rigid system and the piston cannot move to and fro in the cylinder. Unwittingly we have deprived it of all possibility [[sic]] of movement.

Page Break 45

Page 45

249. "Nothing easier than to imagine a four-dimensional cube! It looks like this:†1

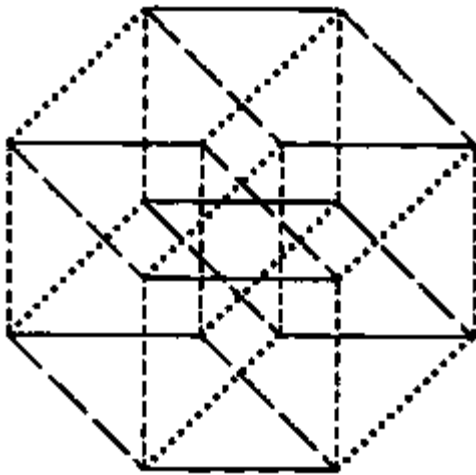

--But I don't mean that, I mean something like

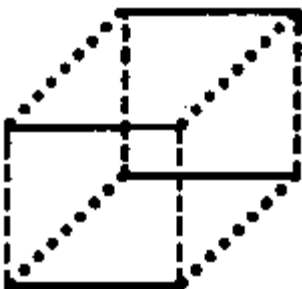

but with four dimensions!--"But isn't what I showed you like

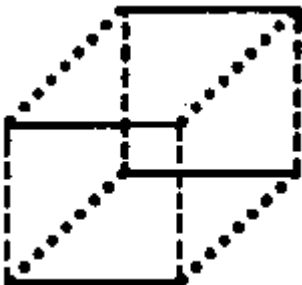

Page Break 46

only with four dimensions?"--No; I don't *mean* that!--But what do I mean? What is my picture? Well, it is *not* the four-dimensional cube as you drew it. I have now for a picture only the *words* and my rejection of anything you can show me.

Page 46

250. Are roses red in the dark?--One can think of the rose in the dark as red.--

(That one can 'imagine' something does not mean that it makes sense to say it.)

251. "The supposition that this person--who behaves quite normally--is nevertheless blind, surely makes sense!"--That means: 'after all it is a supposition.' 'I surely can actually suppose something like that.' And that means: I picture the thing I am supposing. Very well: but does it go any further than that? If in other circumstances, I suppose that someone is blind, I never assure myself that this assumption really makes sense. And my actually imagining something, picturing something, as I make the assumption, plays no part at all in that case. This picture only becomes important here, where it is so to speak the only thing that gives a handle for thinking that I really have supposed something. That is all that is left of there being an assumption here.

252. "I can quite well imagine someone acting like that and nevertheless seeing nothing shameful in the action." There follows a description shewing how this is to be imagined.

"I can imagine a human society in which it counts as dishonest to calculate, except as a pastime." That means roughly the same as: I could easily fill this picture out with more detail.

253. "I haven't ever in fact seen a black patch gradually getting lighter until it was white and then the white turning more and more reddish, until it was red. But I know that it is possible, because I can imagine it."

254. (When you are talking with someone about some division of time, you often take out your watch, not to see what time it is, but to help form a picture of the division being considered.)

255. How can one learn the truth by thinking? As one learns to see a face better if one draws it.

256. Philosophers who think that one can as it were use thought to make an extension of experience, should think about the fact that one can transmit talk, but not measles, by telephone.

Nor can I experience time as limited, when I want to, or my visual field as homogeneous etc.†1

257. Would it be possible to discover a new colour? For a colour-blind man is in the same situation as we are, his colours form just as complete a system as ours do; he doesn't see any gaps where the remaining colours belong.

(Comparison with mathematics.)†2

258. Generality in logic cannot be extended any further than our logical foresight reaches. Or better: than our logical vision reaches.

259. "But how can human understanding outstrip reality and itself *think* the unverifiable?"--Why should we not *say* the unverifiable? For we ourselves made it unverifiable.

A false *appearance* is produced? And how can it so much as *look* like that? For don't you want to say that this *like that* is not a description at all? Well, then it isn't a *false* appearance either, but rather one that robs us of our orientation. So that we clutch our brows and ask: How can that be?

260. It is only apparently possible "to transcend any possible experience", even these words only seem to make sense, because they are arranged on the analogy of significant expressions.

261. The "philosophy of as if" itself rests wholly on this shifting between simile and reality.

262. "But I can't anticipate reality in my thoughts, using words to sneak in something I am *not acquainted* with."
(Nihil est in intellectu....)

As if I could as it were get round and approach from behind in thought, and so snatch a glimpse of what it is impossible to see from the front."

263. Hence there is something right about saying that unimaginability is a criterion for nonsensicality.

264. Suppose someone were to say "I can't imagine what it is like for someone to see a chair, except precisely when I

see it"? Would he be justified in saying this?

Page 48

265. *Am I justified* in saying: "I cannot see ||||| as a shape"?

Page 48

What justifies me? (What justifies the blind man in saying he cannot see?)

Page 48

266. Can you imagine absolute pitch, if you have not got it?--Can you imagine it *if* you have it?--Can a blind man imagine seeing? Can *I* imagine it?--Can I imagine spontaneously reacting thus and so, if I don't do it? Can I imagine it any better, if I do do it? ((Belongs to the question: can I imagine someone seeing ||||| as an articulated shape.))

Page 48

267. Is it supposed to be an empirical fact that someone who has had an experience can imagine it, and that someone else can *not*? (How do I know that a blind man can imagine colours?) But: he cannot play a certain language game (cannot learn it). But is this empirical, or is it the case *eo ipso*? The latter.

Page 48

268. What should we say to someone who asserted that he could imagine exactly what it is like to have absolute pitch without having it?

Page 48

269. If we think we can imagine four-dimensional space, why not also four-dimensional colours, that is colours which, besides degree of saturation, hue, and brightness, allowed of a fourth determination?†1

Page 48

270. "How can it make sense to speak of a kind of sense-perception which is quite new to me, which I shall perhaps have some time? If that is, you do not want to speak of a sense *organ*."

Page 48

271. What purpose is served by a sentence like: "We can't in the least imagine the sensations of a conjurer like Rastelli"?

Page Break 49

Page 49

272. "It makes sense to speak of an endless row of trees; I can surely imagine a row of trees going on without end." That means something like: If it makes sense to say the row of trees comes to an end here, then it makes sense to say [it doesn't come to an end here, and so also that it never comes to an end.]†1 Ramsey used to reply to such questions: "But it *just is* possible to think of such a thing." As, perhaps, one says: "Technology achieves things nowadays which you can't imagine at all."--Well here one has to find out *what* you are thinking. (Your asseveration that this phrase can be *thought*--what can I do with that? For that's not the point. Its purpose is not that of causing a fog to rise in your mind.) *What* you mean--how is that to be discovered? We must patiently examine how this sentence is supposed to be applied. What things look like *round about it*. Then its tense will come to light.

Page 49

273. Hardy: "That 'the finite cannot understand the infinite' should surely be a theological and not a mathematical war-cry." True, the expression is inept. But what people are using it to try and say is: "We mustn't have any juggling! How comes this leap from the finite to the infinite?" Nor is the expression all that nonsensical--only the 'finite' that can't conceive the infinite is not 'man' or 'our understanding', but the calculus. And HOW this conceives the infinite is well worth an investigation. This may be compared to the way a chartered accountant precisely investigates and clarifies the conduct of a business undertaking. The aim is a synoptic comparative account of all the applications, illustrations, conceptions of the calculus. The complete survey of everything that may produce unclarity. And this survey must extend over a wide domain, for the roots of our ideas reach a long way.--"The finite cannot understand the infinite" means here: It cannot work *in the way* you, with characteristic superficiality, are presenting it.

Thought can as it were *fly*, it doesn't have to walk. You do not understand your own transactions, that is to say you do not have a synoptic view of them, and you as it were project your lack of understanding into the idea of a medium in which the most astounding things are possible.

Page Break 50

Page 50

274. The 'actual infinite' is a 'mere word'. It would be better to say: for the moment this expression merely produces a picture -which still hangs in the air: you owe us an account of its application.

Page 50

275. An infinitely long row of marbles, an infinitely long rod. Imagine these coming in in some kind of fairy tale. What application--even though a fictitious one---might be made of this concept? Let us ask now, not "Can there be such a thing?" but "What do we imagine?" So give free rein to your imagination. You can have things now just as you choose. You only need to *say* how you want them. So (just) make a verbal picture, illustrate it as you choose--by drawing, comparisons, etc.! Thus you can--as it were--prepare a blueprint.--And now there remains the question how to work from it. [*Marginal note*: Belongs with 'It depends on the *service*'.]

Page 50

276. I believe I see a design drawn very fine in a bit of a series; which only stands in need of "and so on" to reach to infinity.

"I see a distinctive character in it."--Well, presumably something that corresponds to the algebraic expression.--"Yes, only nothing written, but positively something ethereal."--What a queer picture.--"Something that is not the algebraic expression, something for which this is only the *expression*!"†1

Page 50

277. I see something in it--like a shape in a puzzle picture. And if I see that, I say "That is all I need."--If you find the signpost, you don't now look for further instruction--you *walk*. (And if instead of "you walk" I were to say "you go by it" the difference between the two expressions might be only that the second one alludes to certain psychological accompaniments.)

Page 50

278. What does it mean to say: a straight line can be arbitrarily produced? Is there not an "and so on ad inf." here which is quite different from that of mathematical induction? According to the foregoing there would exist the expression for the possibility of producing the line, in the sense of the description of the produced part, or of its production. Here at first sight there does not seem to be any question of numbers. I can imagine the pencil that draws the line continuing its movement and keeping

Page Break 51

on going the same way. But is it also conceivable that there should be no possibility of accompanying this process with some countable process? I believe not.†1

Page 51

279. When do we say: "The line intimates this to me *like a rule*--always the same"? And on the other hand: "It keeps on intimating to me what I have to do--it is not a rule"?

In the first case the thought is: I have no further court of appeal for what I have to do. The rule does it all by itself: I only have to obey it--(and obeying is *one* thing!). I do not feel, for example: it is queer that the line always tells me something.--The other proposition says: I do not know what I am going to do: the line will tell me.

Page 51

280. One might imagine someone multiplying, correctly multiplying, with such feelings as these; he keeps on saying "I don't know--now the rule suddenly intimates *this* to me!"--and we answer "Of course; you are going on quite in accord with the rule."

Page 51

281. To say that the points yielded in this experiment lie roughly on this line, e.g. on a straight line, means something like: "Seen from this distance they seem to lie on a straight line."

I may say that a stretch gives the general impression of a straight line; but I cannot say this of the line ; although it would be possible to see it as a bit of a longer line in which the deviations from the straight were lost. I cannot say: "This bit of line looks straight, for it may be a bit of a line that as a whole gives me the impression of being straight." (Mountains on the earth and the moon. The earth a ball.)†2

Page 51

282. "It intimates this or that to me, irresponsibly" means: I cannot teach you *how* I follow the line. I do not presuppose that you will follow it as I do, even when you do follow it.

Page 51

283. What does it mean to understand that something is an order, although one does not yet understand the order itself? ("He means I am to do something--but I don't know *what* he wants.")

Page Break 52

Page 52

284. Of course the proposition "I must understand the order before I can act on it" makes good sense: but not a metalogical sense.

285. The idea that one has of understanding in this connexion is roughly that through it one gets a stage nearer from the words to the execution.--In what sense is this right?

286. "But I must understand an order to be able to act according to it." Here the "must" is fishy.
Think too of the question "How long before obeying it must you understand the order?"

287. "I cannot carry out the order because I don't understand what you mean.--Yes, I understand you now."--What went on when I suddenly understood him? Here there were various possibilities. The order may for example have been given with a wrong emphasis; and the right emphasis suddenly occurred to me. In that case I should say to a third party "Now I understand him, he means..." and should repeat the order with the right emphasis. And now, with the right emphasis, I should understand him; that is, I did not now have further to grasp a *sense* (something *outside* the sentence, hence something ethereal) but the familiar sound of English words perfectly suffices me.--Or the order was given me in comprehensible English, but seemed preposterous. Then an explanation occurs to me; and now I can carry it out.--Or several interpretations may have passed through my mind, and I eventually decide on one of them.

288. If the order is *not* executed--where in that case is that shadow of its execution which you think you see; because the form: "He ordered *such-and-such*" swam before your mind.

289. If the meaning-connexion can be set up *before* the order, then it can also be set up afterwards.

290. "He did *what* I told him."--Why should one not say here: There is an identity between action and WORD?! Why should I interpose a shadow between the two? Indeed we have a method of projection.--Only there is a different identity in: "I did what he did" and in: "I did what he ordered."

291. The lines of projection might be called the "connexion between the picture and what it depicts"; but so too might the technique of projection.

292. The ambiguity of our ways of expressing ourselves: If an order were given us in code with the key for translating it into English, we might call the procedure of constructing the English form of the order "derivation of what we have to do from the code" or "derivation of what executing the order is". If on the other hand we act according to the order, obey it, here too in certain cases one may speak of a derivation of the execution.

293. I give the rules of a game. The other party makes a move, perfectly in accord with the rules, whose possibility I had not foreseen, and which spoils the game, that is, as I had wanted it to be. I now have to say: "I gave bad rules; I must change or perhaps add to my rules."

So in this way have I a picture of the game in advance? In a sense: Yes.

It was surely possible, for example, for me not to have foreseen that a quadratic equation need have no real root.

Thus the rule leads me to something of which I say: "I did not expect this pattern: I imagined a solution always like *this*...."

294. In one case we make a move in an existent game, in the other we establish a rule of the game. Moving a piece could be conceived in these two ways: as a paradigm for future moves, or as a move in an actual game.

295. You must remember that there may be such a language-game as 'continuing a series of digits' in which no rule, no expression of a rule is ever given, but learning happens *only* through examples. So that the idea that every step should be justified by a something--a sort of pattern--in our mind, would be alien to these people.

296. How queer: It looks as if a physical (mechanical) form of guidance could misfire and let in something unforeseen, but not a rule! As if a rule were, so to speak, the only reliable form of

guidance. But what does guidance not allowing a movement, and a rule's not allowing it, consist in?--How does one

know the one and how the other?

Page 54

297. "How do I manage always to use a word correctly--i.e. significantly; do I keep on consulting a grammar? No; the fact that I mean something--the thing I mean, prevents me from talking nonsense."--"I mean something by the words" here means: I *know* that I can apply them.

I may however believe I can apply them, when it turns out that I was wrong.

Page 54

298. From this it does not follow that understanding is the activity by which we shew that we understand. It is misleading to ask whether it is this activity. The question ought not to be conceived as: "Is understanding *this* activity then, isn't it a different one instead?"--But rather as: "Is 'understanding' used to designate this activity--isn't its use *different*?"

Page 54

299. We say: "If you really follow the rule in multiplying, it **MUST** come out the same." Now, when this is merely the slightly hysterical style of university talk, we have no need to be particularly interested. It is however the expression of an attitude towards the technique of multiplying, which comes out everywhere in our lives. The emphasis of the 'must' corresponds only to the inexorability of this attitude, not merely towards the technique of calculating, but also towards innumerable related practices.†1

Page 54

300. With the words "*This* number is the right continuation of this series" I may bring it about that for the future someone calls such-and-such the "right continuation". What 'such-and-such' is I can only show in examples. That is, I teach him to continue a series (basic series), without using any expression of the 'law of the series'; rather, I am forming a substratum for the meaning of algebraic rules or what is like them.

Page 54

301. He must go on like this *without a reason*. Not, however, because he cannot yet grasp the reason but because--in *this* system--there is no reason. ("The chain of reasons comes to an end.")

Page Break 55

Page 55

And the *like this* (in "go on like this") is signified by a number, a value. For at *this* level the expression of the rule is explained by the value, not the value by the rule.

Page 55

302. For just where one says "But don't you *see*...?" the rule is no use, it is what is explained, not what does the explaining.

Page 55

303. "He grasps the rule intuitively."--But why the rule? Why not how he is to continue?

Page 55

304. "Once he has seen the right thing, seen the one of infinitely many references which I am trying to push him towards--once he has got hold of it, he will continue the series right without further ado. I grant that he can only guess (intuitively guess) the reference that I mean--but once he has managed that the game is won." But this 'right thing' that I mean does not exist. The comparison is wrong. There is no such thing here as, so to say, a wheel that he is to catch hold of, the right machine which, once chosen, will carry him on automatically. It could be that something of the sort happens in our brain but that is not our concern.

Page 55

305. "Do the same." But in saying this I must point to the rule. So its *application* must already have been learnt. For otherwise what meaning will its expression have for him?

Page 55

306. To guess the meaning of a rule, to grasp it intuitively, could surely mean nothing but: to guess its *application*. And that can't now mean: to guess the kind of application; the rule for it. Nor does guessing come in here.

Page 55

307. I might e.g. guess what continuation will give the other pleasure (by his expression, perhaps). The application of a rule can be guessed only when there is already a choice between different applications.

Page 55

308. We might in that case also imagine that, instead of 'guessing the application of the rule,' he *invents* it. Well, what would that look like? Ought he perhaps to say "Following the rule + 1 may mean writing 1, 1 + 1, 1 + 1 + 1, and so on"? But what does he mean by that? For the "and so on" presupposes that one has already mastered a technique.

Instead of "and so on" he might also have said: "Now you know what I mean." And his explanation would simply be a *definition* of the expression "following the rule + 1". *This* would have been his discovery.

309. We copy the numerals from 1 to 100, say, and this is the way we *infer, think*.

I might put it this way: If I copy the numerals from 1 to 100--how do I know that I shall get a series of numerals that is right when I count them? And here *what* is a check on *what*? Or how am I to describe the important empirical fact here? Am I to say experience teaches that I always count the same way? Or that none of the numerals gets lost in copying? Or that the numerals remain on the paper as they are, even when I don't watch them? Or *all* these facts? Or am I to say that we simply don't get into difficulties? Or that almost always everything seems all right to us?

This is how we think. *This* is how we act. *This* is how we talk about it.

310. Imagine you had to describe how humans learn to count (in the decimal system, for example). You describe what the teacher says and does and how the pupil reacts to it. What the teacher says and does will include e.g. words and gestures which are supposed to encourage the pupil to continue a sequence; and also expressions such as "Now he can count". Now should the description which I give of the process of teaching and learning include, in addition to the teacher's words, my own judgment: the pupil can count now, or: now the pupil has understood the numeral system? If I do not include such a judgment in the description--is it incomplete? And if I do include it, am I going beyond pure description?--Can I refrain from that judgment, giving as my ground: "*That is all that happens*"?

311. Must I not rather ask: "What does the description do anyway? What purpose does it serve?"--In another context, indeed, we know what is a complete and what an incomplete description. Ask yourself: How do we use the expressions "complete" and "incomplete description"?

Giving a complete (or incomplete) report of a speech. Is it part of this to report the tone of voice, the play of expression, the genuineness or falsity of feeling, the intentions of the speaker, the strain of speaking? Whether this or that belongs to a complete description will depend on the purpose of the description, on what the recipient does with the description.

312. The expression "that is all that *happens*" sets limits to what we call "happening".

313. Here the temptation is overwhelming to say something further, when everything has already been described.--Whence this pressure? What analogy, what wrong interpretation produces it?

314. Here we come up against a remarkable and characteristic phenomenon in philosophical investigation: the difficulty--I might say--is not that of finding the solution but rather that of recognizing as the solution something that looks as if it were only a preliminary to it. "We have already said everything.--Not anything that follows from this, no, *this* itself is the solution!"

This is connected, I believe, with our wrongly expecting an explanation, whereas the solution of the difficulty is a description, if we give it the right place in our considerations. If we dwell upon it, and do not try to get beyond it.

The difficulty here is: to stop.

315. "Why do you demand explanations? If they are given you, you will once more be facing a terminus. They cannot get you any further than you are at present."

316. A red object can be used as a sample for painting a *reddish* white or a reddish yellow (etc.)--but can it also be used as a sample for painting a shade of bluish green?--Suppose I saw someone, with all the outward signs of making an exact copy, 'reproducing' a red patch bluish green?--I should say: "I don't know how he's doing it" or even "I don't know *what* he's doing."--But supposing that he now 'copied' this shade of red bluish green on various occasions, and perhaps other shades of red systematically other shades of bluish green--ought I now to say he's copying, or he isn't copying?

But what does it mean to say that I don't know 'what he's doing'? For can't I see what he's doing?--But I can't see *into him*.--Avoid that comparison! Suppose I see him copying red as red--what do I know here? Do I know *how* I do it? Of course one says: "I'm just painting the *same* colour."--But suppose *he* says: "And I'm painting the *fifth* of this colour"? Can I see a special mediating process when *I* paint the 'same' colour?

Assume I know him for an honest man; he reproduces a red, as I described, by a bluish green--but now *not* the same shade by always the same shade, but sometimes one, sometimes another. Am I to say "I don't know what he's doing?"--He does what I can see--but *I* should never do it; I don't know, why he does it; his proceeding 'is unintelligible to me'.

317. We might imagine a negative portrait, that is one that is *supposed* to represent how Herr N does *not* look (and so is a bad portrait if it looks like N).

318. I cannot describe how (in general) to employ rules, except by *teaching* you, *training* you to employ rules.

319. I may now e.g. make a talkie of such instruction. The teacher will sometimes say "That's right." If the pupil should ask him "Why?"--he will answer nothing, or at any rate nothing relevant, not even: "Well, because we all do it like that"; that will not be the reason.

320. Why don't I call cookery rules arbitrary, and why am I tempted to call the rules of grammar arbitrary? Because 'cookery' is defined by its end, whereas 'speaking' is not. That is why the use of language is in a certain sense autonomous, as cooking and washing are not. You cook badly if you are guided in your cooking by rules other than the right ones; but if you follow other rules than those of chess you are *playing another game*; and if you follow grammatical rules other than such-and-such ones, that does not mean you say something wrong, no, you are speaking of something else.

321. When a rule concerning a word in it is appended to a sentence, the sense does not change.

322. Language is not defined for us as an arrangement fulfilling a definite purpose. Rather "language" is for us a name for a collection, and I understand it as including German, English and so on, and further various systems of signs which have more or less affinity with these languages.

323. Being acquainted with many languages prevents us from taking quite seriously a philosophy which is laid down in the forms of any one. But here we are blind to the fact that we ourselves have strong prejudices for, and against, certain forms of expression; that this very piling up of a lot of languages results in our having a particular picture.

324. Does a child learn only to talk, or also to think? Does it learn the sense of multiplication *before*--or *after* it learns multiplication?

325. How did I arrive at the concept 'sentence' or 'language'? Surely only through the languages that I have learnt.--But they seem to me in a certain sense to have led beyond themselves, for I am now able to construct new language, e.g. to invent words.--So such construction also belongs to the concept of language. But only because that is how I want to fix the concept.

326. The concept of a living being has the same indeterminacy as that of a language.

327. Compare: inventing a game--inventing language--inventing a machine.

328. In philosophy it is significant that such-and-such a sentence makes no sense; but also that it sounds funny.

329. I make a plan not merely so as to make myself understood but also in order to get clear about the matter myself. (I.e. language is not merely a means of communication.)

330. What does it mean to say: "But that's no longer the same game!" How do I use this sentence? As information?

Well, perhaps to introduce some information in which differences are enumerated and their consequences explained. But also to express that just for that reason I don't join in here, or at any rate take up a different attitude to the game.

Page Break 60

Page 60

331. One is tempted to justify rules of grammar by sentences like "But there really are four primary colours". And the saying that the rules of grammar are arbitrary is directed against the possibility of this justification, which is constructed on the model of justifying a sentence by pointing to what verifies it.

Yet can't it after all be said that in some sense or other the grammar of colour-words characterizes the world as it actually is? One would like to say: May I not really look in vain for a fifth primary colour? Doesn't one put the primary colours together because there is a similarity among them, or at least put *colours* together, contrasting them with e.g. shapes or notes, because there is a similarity among them? Or, when I set this up as the right way of dividing up the world, have I a preconceived idea in my head as a paradigm? Of which in that case I can only say: "Yes, that is the kind of way we look at things" or "We just do want to form this sort of picture." For if I say "there is a particular similarity among the primary colours"--whence do I derive the idea of this similarity? Just as the idea 'primary colour' is nothing else but 'blue or red or green or yellow'--is not the idea of that similarity too given simply by the four colours? Indeed, aren't they the same?--"Then might one also take red, green and circular together?"--Why not?!

Page 60

332. Do not believe that you have the concept of colour within you because you look at a coloured object--however you look.

(Any more than you possess the concept of a negative number by having debts.)

Page 60

333. "Red is something specific"--that would have to mean the same as: "*That* is something specific"--said while pointing to something red. But for that to be intelligible, one would have already to mean our *concept* 'red', to mean the use of that sample.

Page 60

334. I can indeed obviously express an expectation at one time by the words "I'm expecting a red circle," and at another by putting a coloured picture of a red circle in the place of the last few words. But in this expression there are not two things corresponding to the two separate words "red" and "circle". So the expression in the second language is of a *completely different kind*.

Page Break 61

Page 61

335. There might be another language, besides this last one, in which 'red circle' was expressed by the juxtaposition of a circle and a red patch.

Page 61

336. Now if I have two signs at hand, the expression "red circle" and the coloured picture, or image, of the red circle, then surely the question would be: How is the one word correlated with the shape, the other with the colour?

For it seems possible to say: one word turns the attention to the colour, the other to the shape. But what does that mean? How can these separate words be translated into this pattern?

Or again: If the word "red" summons up a colour in my memory, it must surely be in connexion with a shape; in that case how can I abstract from the shape?

The important question here is never: how does he know what to abstract from? but: how is this possible at all? or: what does it mean?

Page 61

337. Perhaps it becomes clearer if we compare *these* two languages: in one the phrase "red circle" is replaced by a red slip and a slip with a circle on it (say black on a white ground); and in the other by a red circle.

For how does translating proceed here? Say one looks at the red slip and chooses a red pencil, then at the circle, and now one makes a circle with this pencil.

It would first of all have been learnt that the first slip always determines the choice of the pencil, and the second what we should draw with it. Thus the two slips belong to two different parts of speech (say noun and activity-word). But in the other language there would be nothing that could be called two different words.

Page 61

338. If someone were to say: "Red is complex"--we could not guess what he was alluding to, what he was trying to do with this sentence. But if he says "This chair is complex," we may indeed not know straight off which kind of complexity he is talking about, but we can straight away think of more than one sense for his assertion.

Now what kind of fact am I drawing attention to here?

At any rate it is an *important* fact.--We are not familiar with any technique, to which that sentence might be alluding.

Page Break 62

Page 62

339. We are here describing a language-game that *we cannot learn*.

Page 62

340. "In that case something quite different must be going on in him, something that we are not acquainted with."--*This shews us* what we go by in determining whether something that takes place 'in another' is different from, or the same as in ourselves. This shews us *what we go by* in judging inner processes.

Page 62

341. Can you imagine what a red-green colour blind man sees? Can you paint a picture of the room as he sees it? Can *he* paint it as he sees it? Then can I paint it as I see it? In what sense can I?

Page 62

342. "If someone saw only grey, black and white, he would have to be *given* something if he were to know what red, green etc. are." And what would he have to be given? Well, the colours. And so, for example, *this* and *this* and *this*. (Imagine, e.g. that coloured patterns had to be introduced into his brain in addition to the merely grey and black ones.) But would this have to happen for the purpose of future action? Or does this action itself involve these patterns? Am I trying to say: "Something would have to be given him, for it is clear that otherwise he could not..."--or: His seeing behaviour *contains* new constituents?

Page 62

343. Again: what should we *call* an "explanation of seeing"? Is one to say: Well, you surely know what "explanation" means elsewhere; so employ this concept here too.

Page 62

344. Can I say: "Look at it! Then you'll see that it can't be explained!"--Or: "Drink in the colour red, then you'll see that it can never be presented by anything else."--And if the other man now agrees with me, does that shew that he has drunk in the same as I?--And what is the significance of our inclination to say this? Red seems to stand there, isolated. Why? What is the *value* of this appearance, this inclination of ours?
But one might ask: What peculiarity of the concept does this inclination point to?

Page 62

345. Think of the sentence: "Red is not a mixed colour" and of its function.

For the language-game with colours is characterized by what we can do and what we cannot do.

Page Break 63

Page 63

346. "There is no such thing as a reddish green" is akin to the sentences that we use as axioms in mathematics.

Page 63

347. The fact that we *calculate* with certain concepts and not with others only shews how various in kind conceptual tools are (how little reason we have here ever to assume uniformity). [*Marginal Note*: On propositions about colours that are like mathematical ones e.g. Blue is darker than white. On this Goethe's Theory of Colour.]

Page 63

348. "The possibility of agreement involves *some* sort of agreement already."--Suppose someone were to say: "Being able to play chess is a sort of playing chess"!

Page 63

349. It is very difficult to describe paths of thought where there are already many lines of thought laid down,--your own or other people's--and not to get into one of the grooves. It is difficult to deviate from an old line of thought *just a little*.

Page 63

350. "It is as if our concepts involved a scaffolding of facts."

That would presumably mean: If you imagine certain facts otherwise, describe them otherwise, than the way they are, then you can no longer imagine the application of certain concepts, because the rules for their application have no analogue in the new circumstances.--So what I am saying comes to *this*: A law is given for human beings, and a jurispudent may well be capable of drawing consequences for any case that ordinarily comes his way; thus the law evidently has its use, makes sense. Nevertheless its validity presupposes all sorts of things, and if the being that he is to judge is quite deviant from ordinary human beings, then e.g. the decision whether he has done a deed with evil intent will become not difficult but (simply) impossible.

Page 63

351. "If humans were not in general agreed about the colours of things, if undetermined cases were not exceptional, then our concept of colour could not exist." No:--our concept *would* not exist.

Page 63

352. Do I want to say, then, that certain facts are favourable to the formation of certain concepts; or again unfavourable? And does experience teach us this? It is a fact of experience that human beings alter their concepts, exchange them for others

Page Break 64

when they learn new facts; when in this way what was formerly important to them becomes unimportant, and *vice versa*. (It is discovered e.g. that what formerly counted as a difference in kind, is really *only* a difference in degree.)

Page 64

353. But may it not be said: "If there were only *one* substance, there would be no use for the word 'substance'"? That however presumably means: The concept 'substance' presupposes the concept 'difference of substance'. (As that of the king in chess presupposes that of a move in chess, or that of *colour* that of *colours*.)

Page 64

354. I want to say that there is a geometrical gap, not a physical one, between green and red.†1

Page 64

355. But doesn't anything physical correspond to it? I do not deny that. (And suppose it were merely our habituation to *these* concepts, to these language-games? But I am not saying that it is so.) If we teach a human being such-and-such a technique by means of examples,--that he then proceeds like *this* and not like *that* in a particular new case, or that in this case he gets stuck, and thus that this and not that is the 'natural' continuation for him: this of itself is an extremely important fact of nature.

Page 64

356. "But if by 'bluish yellow' I mean green, I am taking this expression in a different way from the original one. The original conception signifies a different road, a *no thoroughfare*."

But what is the right simile here? That of a road that is physically impassable, or of the non-existence of a road? i.e. is it one of physical or of mathematical impossibility?

Page 64

357. We have a colour system as we have a number system.

Do the systems reside in *our* nature or in the nature of things? How are we to put it?--*Not* in the nature of numbers or colours.

Page Break 65

Page 65

358. Then is there something arbitrary about this system? Yes and no. It is akin both to what is arbitrary and to what is non-arbitrary.

Page 65

359. It is obvious at a glance that we aren't willing to acknowledge anything as a colour intermediate between red and green. (Nor does it matter whether this is always obvious, or whether it takes experience and education to make it so.)

Page 65

360. 'a is between b and c, and nearer to b than to c': this is a characteristic relation between sensations of the same kind. That is, there is e.g. a language-game with the order "Produce a sensation between *this* and *this*, and nearer the first than the second." And also "Name two sensations which *this* is between."

Page 65

361. And here it is important that e.g. with *grey* one will get "black and white" for answer, with *purple* "blue and red", with *pink* "red and white", but with *olive green* one will *not* get "red and green."

Page 65

362. These people are acquainted with reddish green--"But there *is* no such thing!"--What an extraordinary sentence.--(How do you know?)

Page 65

363. Let's just put it like this: Must these people notice the discrepancy? Perhaps they are too stupid. And again: perhaps not that either.--

Page 65

364. Yes, but has nature nothing to say here? Indeed she has--but she makes herself audible in another way.

"You'll surely run up against existence and non-existence somewhere!" But that means against *facts*, not concepts.

Page 65

365. It is an extremely important fact that a colour which we are inclined to call (e.g.) "reddish yellow" can really be produced (in various ways) by a mixture of red and yellow. And that we are not able to recognize straight off a colour that has come about by mixing red and green as one that can be produced in that way. (But what does "straight off" signify here?)

Page Break 66

Page 66

366. Confusion of tastes: I say "This is sweet", someone else "This is sour" and so on. So someone comes along and says: "You have none of you any idea what you are talking about. You no longer know at all what you once called a taste." What would be the sign of our still knowing? ((Connects with a question about confusion in calculating.))

Page 66

367. But might we not play a language-game even in this 'confusion'?--But is it still the earlier one?--†1

Page 66

368. Let us imagine men who express a colour intermediate between red and yellow, say by means of a fraction in a kind of binary notation like this: R, LLRL and the like, where we have (say) yellow on the right, and red on the left.--These people learn how to describe shades of colour in this way in the kindergarten, how to use such descriptions in picking colours out, in mixing them, etc. They would be related to us roughly as people with absolute pitch are to those who lack it. *They can do* what we cannot.

Page 66

369. And here one would like to say: "But then, is it imaginable? Of course, the *behaviour* is! But is the inner process, the experience of colour?" And it is difficult to see what to say in answer to such a question. Could people without absolute pitch have guessed at the existence of people with absolute pitch?

Page 66

370. High-lights or reflections: when a child paints it will never paint these. Indeed it is quite hard to believe that they can be represented by ordinary oil or water colours.

Page 66

371. What would a society all of deaf men be like? Or a society of the 'feebleminded'? *An important question!* What then of a society that never played many of our customary language-games?

Page 66

372. One imagines the feeble-minded under the aspect of the degenerate, the essentially incomplete, as it were in tatters. And so under that of disorder instead of a more primitive order (which would be a far more fruitful way of looking at them).

We just don't see a *society* of such people.

Page Break 67

Page 67

373. Concepts other than though akin to ours might seem *very* queer to us; deviations from the usual *in an unusual direction*.

Page 67

374. Concepts with fixed limits would demand a uniformity of behaviour. But where I am *certain*, someone else is uncertain. And that is a fact of nature.

Page 67

375. These are the fixed rails along which all our thinking runs, and so our judgment and action goes according to them too.

Page 67

376. Where e.g. a certain type is only seldom to be found, no concept of that type will be formed. People do not feel *this* as a unity, as a particular physiognomy.

Page 67

377. They make no picture of it and always recognize it just in the particular cases.

Page 67

378. Must people be acquainted with the concept of modesty or of swaggering, wherever there are modest and swaggering men? Perhaps nothing hangs on this difference for them.

For us, too, many differences are unimportant, which we might find important.

379. And others have concepts that cut across ours.

380. A tribe has two concepts, akin to our 'pain'. One is applied where there is visible damage and is linked with tending, pity etc. The other is used for stomachache for example, and is tied up with mockery of anyone who complains. "But then do they really not notice the similarity?"--Do we have a single concept everywhere where there is a similarity? The question is: Is the similarity *important* to them? And need it be so? And why should their concept 'pain' not split ours up?

381. But in that case isn't this man overlooking something that is there?--He takes no notice of it, and why should he?--But in that case his concept just is fundamentally different from ours.--*Fundamentally* different? Different.--But in that case it surely is as if his word could not *designate* the *same* as ours. Or only part

of that.--But of course it must look like that, if his concept is different. For the indefiniteness of our concept may be projected for us into the *object* that the word designates. So that if the indefiniteness were missing we should also not have 'the same thing meant'. The picture that we employ symbolizes the indefiniteness.

382. In philosophizing we may not *terminate* a disease of thought. It must run its natural course, and *slow* cure is all important. (That is why mathematicians are such bad philosophers.)

383. Imagine that the people of a tribe were brought up from early youth to give no expression of feeling *of any kind*. They find it childish, something to be got rid of. Let the training be severe. 'Pain' is not spoken of; especially not in the form of a conjecture "Perhaps he has got...." If anyone complains, he is ridiculed or punished. There is no such thing as the suspicion of shamming. Complaining is so to speak already shamming.

384. "Shamming," these people might say, "What a ridiculous concept!" (As if one were to distinguish between a murder with one shot and one with three.)

385. Complaining is already so bad that there is no room at all for shamming as something worse.

386. One disgrace is invisible to them because of the other.

387. I want to say: an education quite different from ours might also be the foundation for quite different concepts.

388. For here life would run on differently.--What interests us would not interest *them*. Here different concepts would no longer be unimaginable. In fact, this is the only way in which *essentially* different concepts are imaginable.

389. [Someone] might surely be taught e.g. to mime pain (not with the intention of deceiving). But could this be taught to just anyone? I mean: someone might well learn to give certain crude tokens of pain, but without ever spontaneously giving a

finer imitation out of his own insight. (Talent for languages.) (A clever dog might perhaps be taught to give a kind of whine of pain but it would never get as far as conscious imitation.)

390. 'These men would have nothing human about them.' Why?--We could not possibly make ourselves understood to them. Not even as we can to a dog. We could not find our feet with them.

And yet there surely could be such beings, who in other respects were human.

391. I really want to say that scruples in thinking begin with (have their roots in) instinct. Or again: a language-game does not have its origin in *consideration*. Consideration is part of a language-game.

And that is why a concept is in its element within the language-game.

392. 'Heap of sand' is a concept without sharp boundaries--but why isn't one with sharp boundaries used instead of it?--Is the reason to be found in the nature of the heaps? What is the phenomenon whose nature is definitive for our concept?

393. It is easy to imagine and work out in full detail events which, if they actually came about, would throw us out in all our judgments.

If I were sometime to see quite new surroundings from my window instead of the long familiar ones, if things, humans and animals were to behave as they never did before, then I should say something like "I have gone mad"; but that would merely be an expression of giving up the attempt to know my way about. And the same thing might befall me in mathematics. It might e.g. *seem* as if I kept on making mistakes in calculating, so that no answer seemed reliable to me.

But the important thing about this for me is that there isn't any sharp line between such a condition and the normal one. [*Marginal note*: Hangs together with the concept of 'knowledge'.]

394. What would it mean for me to be wrong about his having a mind, having consciousness? And what would it mean for me to be wrong about *myself* and not have any? What would it mean

to say "I am not conscious"?--But don't I know that there is a consciousness in me?--Do I know it then, and yet the statement that it is so has no purpose?

And how remarkable that one can learn to make oneself understood to others in these matters!

395. A man can pretend to be unconscious; but *conscious*?

396. What would it be like for someone to tell me with complete seriousness that he (really) did not know whether he was dreaming or awake?--

Is the following situation possible: Someone says "I believe I am now dreaming"; he actually wakes up soon afterwards, remembers that utterance in his dream and says "So I was right!"--This narrative can surely only signify: Someone dreamt that he had said he was dreaming.

Imagine an unconscious man (anaesthetised, say) were to say "I am conscious"--should we say "He ought to know"?

And if someone talked in his sleep and said "I am asleep"--should we say "He's quite right"?

Is someone speaking untruth if he says to me "I am not conscious"? (And truth, if he says it while unconscious? And suppose a parrot says "I don't understand a word", or a gramophone: "I am only a machine"?)

397. Suppose it were part of my day-dream to say: "I am merely engaged in phantasy", would this be *true*? Suppose I write such a phantasy or narrative, an imaginary dialogue, and in it I say "I am engaged in phantasy"--but, when I write it down,--how does it come out that these words belong to the phantasy and that I have not emerged from the phantasy?

Might it not actually happen that a dreamer, as it were emerging from the dream, said in his sleep "I am dreaming"? It is quite imaginable there should be such a language-game.

This hangs together with the problem of 'meaning'. For I can write "I am healthy" in the dialogue of a play, and so not *mean* it, although it is true. The words belong to this and not that language-game.

398. 'True' and 'false' in a dream. I dream that it is raining, and that I say "It is raining"--on the other hand: I dream that I say "I am dreaming".

399. Has the verb "to dream" a present tense? How does a person learn to use this?

400. Suppose I were to have an experience like waking up, were then to find myself in quite different surroundings, with people who assure me that I have been asleep. Suppose further I insisted that I had not been dreaming, but living in some way outside my sleeping body. What function has this assertion?

401. "I have consciousness"--that is a statement about which no doubt is possible." Why should that not say the same as: "I have consciousness' is not a proposition"?

It might also be said: What's the harm if someone says that "I have consciousness" is a statement admitting of no doubt? How do I come into conflict with him? Suppose someone were to say this to me--why shouldn't I get used to making no answer to him instead of starting an argument? Why shouldn't I treat his words like his whistling

or humming?

Page 71

402. "Nothing is so certain as that I possess consciousness." In that case, why shouldn't I let the matter rest? This certainty is like a mighty force whose point of application does not move, and so no work is accomplished by it.

Page 71

403. Remember: most people say one feels nothing under anaesthetic. But some say: It *could* be that one feels, and simply forgets it completely.

If then there are here some who doubt and some whom no doubt assails, still the lack of doubt might after all be far more general.

Page 71

404. Or doubt might after all have a different and much less indefinite form than in our world of thought.

Page 71

405. No one but a philosopher would say "I know that I have two hands"; but one may well say: "I am unable to doubt that I have two hands."

Page 71

406. "Know," however, is not ordinarily used in this sense. "I know what 97×78 is." "I know that 97×78 is 432." In the first case I tell someone that I can do something, that I possess something; in the second I simply asseverate that 97×78 is 432.

Page Break 72

For doesn't " 97×78 is quite definitely 432" say: *I know* it is so? The first sentence is not an arithmetical one, nor can it be replaced by an arithmetical one; an arithmetical sentence could be used in place of the second one.

Page 72

407. Can someone *believe* that $25 \times 25 = 625$? What does it mean to believe that? How does it come out that he believes it?

Page 72

408. But isn't there a phenomenon of knowing, as it were quite apart from the sense of the phrase "I know"? Is it not remarkable that a man can *know* something, can as it were have the fact within him?--But that is a wrong picture.--For, it is said, it's only knowledge if things really are as he says. But that is not enough. It mustn't be just an accident that they are. For he has got to know that he knows: for knowing is a state of his own mind; he cannot be in doubt or error about it--apart from some special sort of blindness. If then knowledge *that* things are so is only knowledge if they *really* are so; and if knowledge is in him so that he cannot go wrong about whether it is knowledge; in that case, then, he is also infallible about things being so, just as he knows his knowledge; and so the fact which he knows must be within him just like the knowledge.

And this does indeed point to one kind of use for "I know". "I know that it is so" then means: It is so, or else I'm crazy.

So: when I say, without lying: "I know that it is so", then only through a special sort of blindness can I be wrong.

Page 72

409. How does it come about that doubt is not subject to arbitrary choice?--And that being so--might not a child doubt everything because it was so remarkably talented?

Page 72

410. A person can doubt only if he has learnt certain things; as he can miscalculate only if he has learnt to calculate. In that case it is indeed involuntary.

Page 72

411. Imagine that a child was quite specially clever, so clever that he could at once be taught the doubtfulness of the existence of all things. So he learns from the beginning: "That is probably a chair."

And now how does he learn the question: "Is it also really a chair?"--

Page Break 73

Page 73

412. Am I doing child psychology?--I am making a connexion between the concept of teaching and the concept of meaning.

Page 73

413. One man is a convinced realist, another a convinced idealist and teaches his children accordingly. In such an important matter as the existence or non-existence of the external world they don't want to teach their children anything wrong.

What will the children be taught? To include in what they say: "There are physical objects" or the opposite?

If someone does not believe in fairies, he does not need to teach his children "There are no fairies": he can omit to teach them the word "fairy". On what occasion are they to say: "There are..." or "There are no..."? Only when they meet people of the contrary belief.

Page 73

414. But the idealist will teach his children the word "chair" after all, for of course he wants to teach them to do this and that, e.g. to fetch a chair. Then where will be the difference between what the idealist-educated children say and the realist ones? Won't the difference only be one of battle cry?

Page 73

415. For doesn't the game "That is probably a..." begin with disillusion? And can the first attitude of all be directed towards a possible disillusion?

Page 73

416. "So does he have to begin by being taught a false certainty?"

There isn't any question of certainty or uncertainty yet in their language-game. Remember: they are learning to *do* something.

Page 73

417. The language-game "What is that?"--"A chair."--is not the same as: "What do you take that for?"--"It might be a chair."

Page 73

418. To begin by teaching someone "That looks red" makes no sense. For he must say that spontaneously once he has learnt what "red" means, i.e. has learnt the technique of using the word.

Page 73

419. Any explanation has its foundation in training. (Educators ought to remember this.)

Page 73

420. "It looks red to me."--"And what is red like?"--"Like *this*." Here the right paradigm must be pointed to.

Page Break 74

Page 74

421. When he first learns the names of colours--what is taught him? Well, he learns e.g. to call out "red" on seeing something red.--But is that the right description; or ought it to have gone: "He learns to call 'red' *what we too* call 'red'"?--Both descriptions are right.

What differentiates this from the language-game "How does it strike you?"?

But someone might be taught colour-vocabulary by being made to look at white objects through coloured spectacles. What I teach him however must be a *capacity*. So he *can* now bring something red at an order; or arrange objects according to colour. But then what is something red?

Page 74

422. Why doesn't one teach a child the language-game "It looks red to me" from the first? Because it is not yet able to understand the rather fine distinction between seeming and being?

Page 74

423. The red visual impression is a new *concept*.

Page 74

424. The language-game that we teach him then is: "It looks to me..., it looks to you..." In the first language-game a person does not occur as perceiving subject.

Page 74

425. You give the language game a new joint. Which does not mean, however, that now it is always used.

Page 74

426. The inward glance at the sensation--what connexion is this supposed to set up between words and sensation; and what purpose is served by this connexion? Was I taught *that* when I learned to use this sentence, to think this thought? (Thinking it really was something I had to learn.)

This is indeed something further that we learn, namely to turn our attention on to things and on to sensations. We learn to observe and to describe observations. But how am I taught this; how is my 'inner activity' checked in this case? How will it be judged whether I really have paid attention?

Page 74

427. "The chair is the same whether I am looking at it or not"--that *need* not have been true. People are often embarrassed when one looks at them. "The chair goes on existing, whether I look at it or not." This might be treated as an empirical proposition or it might be that we took it as a grammatical one. But it is also possible in this connexion simply to think of the conceptual difference between sense-impression and object [*Objekt*].

428. But isn't human agreement essential to the game? Must not anybody who learns it first know the meaning of "same", and do not the presuppositions of this include agreement? And so on.

429. You say "*That* is red," but how is it decided if you are right? Doesn't human agreement decide?--But do I appeal to this agreement in my judgments of colour? Then is what goes on like *this*: I get a number of people to look at an object; to each of them there occurs one of a certain group of words (what are called the "names of colours"); if the word "red" occurred to the majority of the spectators (I myself need not belong to this majority) the predicate "red" belongs to the object by rights. Such a technique might have its importance.

430. *Colour-words* are explained like *this*: "That's red" e.g.--Our language game only works, of course, when a certain agreement prevails, but the concept of agreement does not enter into the language-game. If agreement were universal, we should be quite unacquainted with the concept of it.

431. Does human agreement *decide* what is red? Is it decided by appeal to the majority? Were we taught to determine colour in *that* way?

432. For I describe the language-game "Bring something red" to someone who can himself already play it. Others I might at most teach it. (Relativity.)

433. "What I perceive is *THIS*--" and now follows a form of DESCRIPTION. The word "this" might also be explained as follows: Let us imagine a direct transfer of experience.--But now what is our criterion for the experience's really having been transferred? "Well, he just does have what I have."--But how does *he 'have'* it?

434. What does it mean "to use a word as a designation, a name, of a sensation"? Isn't there something to investigate here?

Imagine you were starting from a language-game with physical objects--and then it was said, from now on *sensations* are going to be named too. Wouldn't that be as if first there were talk of

transferring possessions and then suddenly of transferring joy in possession or pride in possession? Don't we have to learn something new here? Something new, which we call "transferring" too.

435. The description of what is subjectively seen is more or less akin to the description of an object, but just for that reason does not function as a description of an object. How are visual sensations compared? How do I compare my visual sensations with someone else's?

436. "Verifying by inspection" is a wholly misleading expression. For it says that first of all a procedure, the inspection, takes place (it might be compared with looking through a microscope, or with the procedure of turning one's head round *in order to see something*). And that then the seeing has to succeed. One might speak of "seeing by turning round," or "seeing by looking". But in that case the turning round (or looking) is a process external to the seeing, a process that is thus of only practical concern. What one would like to say is "seeing by seeing".

437. The causes of our belief in a proposition are indeed irrelevant to the question what we believe. Not so the grounds, which are grammatically related to the proposition, and tell us what proposition it is.

438. Nothing is commoner than for the meaning of an expression to oscillate, for a phenomenon to be regarded sometimes as a symptom, sometimes as a criterion, of a state of affairs. And mostly in such a case the shift of meaning is not noted. In science it is usual to make phenomena that allow of exact measurement into defining criteria for an expression; and then one is inclined to think that now the proper meaning has been *found*. Innumerable confusions have arisen in this way.

There are for example degrees of pleasure, but it is stupid to speak of a measurement of pleasure. It is true that in certain cases a measurable phenomenon occupies the place previously occupied by a non-measurable one. Then the word designating this place changes its meaning, and its old meaning has become more or less obsolete. We are soothed by the fact that the one

concept is the more exact, the other the more inexact one, and do not notice that here in each particular case a different relation between the 'exact' and the 'inexact' concept is in question: it is the old mistake of not testing particular cases.

439. Sufficient evidence passes over into insufficient without a definite borderline. Shall I say that a natural foundation for the way this concept is formed is the complex nature and the variety of human contingencies?

Then given much less variety, a sharply bounded conceptual structure would have to seem natural. And why does it seem so difficult to imagine the simplified case?

440. How should we have to imagine a complete list of rules for the employment of a word?--What do we mean by a complete list of rules for the employment of a piece in chess? Couldn't we always construct doubtful cases, in which the normal list of rules does not decide? Think e.g. of such a question as: how to determine who moved last, if a doubt is raised about the reliability of the players' memories?

The regulation of traffic in the streets permits and forbids certain actions on the part of drivers and pedestrians; but it does not attempt to guide the totality of their movements by prescription. And it would be senseless to talk of an 'ideal' ordering of traffic which should do that; in the first place we should have no idea what to imagine as this ideal. If someone wants to make traffic regulations stricter on some point or other, that does not mean that he wants to approximate to such an ideal.

441. Consider also the following proposition: "The rules of a game may well allow a certain freedom, but all the same they must be quite definite rules." That is as if one were to say: "You may indeed leave a person enclosed by four walls a certain liberty of movement, but the walls must be perfectly rigid"--and that is not true.--"Well, the walls may be elastic all right, but in that case they have a perfectly determinate degree of elasticity"--But what does this say? It seems to say that it must be possible to state the elasticity, but that again is not true. "The wall always has *some determinate* degree of elasticity--whether I know it or

not": that is really the avowal of adherence to a form of expression. The one that makes use of the *form* of an ideal of accuracy. As it were like the form of a parameter of representation.

442. The avowal of adherence to a form of expression, if it is formulated in the guise of a proposition dealing with *objects* (instead of signs) must be '*a priori*'. For its opposite will really be unthinkable, inasmuch as there corresponds to it a form of thought, a form of expression, that we have excluded.

443. Suppose people used always to point to objects in the following way: they describe a circle as it were round the object with their finger in the air; in that case a philosopher could be imagined who said: "All things are circular, for the table looks like *this*, the stove like *this*, the lamp like *this*", etc., drawing a circle round the thing each time.

444. We now have a *theory*, a 'dynamic theory'†* of the proposition; of language, but it does not present itself to us as a theory. For it is the characteristic thing about such a theory that it looks at a special clearly intuitive case and says: "*That* shews how things are in every case; this case is the exemplar of *all* cases."--"Of course! It has to be like that" we say, and are satisfied. We have arrived at a form of expression that *strikes us as obvious*. But it is as if we had now seen something lying *beneath* the surface.

The tendency to generalize the case seems to have a strict justification in logic: here one seems *completely* justified in inferring: "If *one* proposition is a picture, then any proposition must be a picture, for they must all be of the same nature." For we are under the illusion that what is sublime, what is essential, about our investigation consists in its grasping *one* comprehensive essence.

445. How can I understand a proposition *now*, if it is for analysis to shew *what* I really understand?--Here there sneaks in the idea of understanding as a special mental process.

446. But don't think of understanding as a 'mental process' at all.--For *that* is the way of speaking that is confusing

you. Rather ask yourself: in what kind of case, under what circumstances do we say "Now I can go on," if the formula has occurred to us?†1

That way of speaking is what prevents us from seeing the facts without prejudice. Consider the pronunciation of a word as its spelling presents it. How easy it is to persuade oneself that two words--e.g. "fore" and "four" sound different in everyday use--because one pronounces them differently when one has the difference in spelling directly in view. Comparable with this is the opinion that a violin player with a fine sense of pitch always strikes F somewhat higher than E sharp. Reflect on such cases.--*That* is how it can come about that the means of representation produces something *imaginary*. So let us not think we *must* find a specific mental process, because the verb "to understand" is there and because one says: Understanding is an activity of mind.

Page 79

447. Disquiet in philosophy might be said to arise from looking at philosophy wrongly, seeing it wrong, namely as if it were divided into (infinite) longitudinal strips instead of into (finite) cross strips. This inversion in our conception produces the *greatest* difficulty. So we try as it were to grasp the unlimited strips and complain that it cannot be done piecemeal. To be sure it cannot, if by a piece one means an infinite longitudinal strip. But it may well be done, if one means a cross-strip.--But in that case we never get to the end of our work!--Of course not, for it has no end.

(We want to replace wild conjectures and explanations by quiet weighing of linguistic facts.)

Page 79

448. And does one say that the sentence "It's raining" says: such-and-such is the case? What is the everyday use of this expression in ordinary language? For you learned it from this use. If you now use it contrary to its original use, and think you are still playing the old game with it, that is as if you were to play draughts with chess-pieces and imagine that your game had kept something of the spirit of chess.

Page Break 80

Page 80

449. Extension of a concept in a *theory* (e.g. 'wish-fulfilment dream').

Page 80

450. One who philosophizes often makes the wrong, inappropriate gesture for a verbal expression.

Page 80

451. (One says the ordinary thing--with the wrong gesture.)

Page 80

452. How does it come about that philosophy is so complicated a structure? It surely ought to be completely simple, if it is the ultimate thing, independent of all experience, that you make it out to be.--Philosophy unties knots in our thinking; hence its result must be simple, but philosophizing has to be as complicated as the knots it unties.†1

Page 80

453. (As one can sometimes reproduce music only in one's inward ear, and cannot whistle it, because the whistling drowns out the inner voice, so sometimes the voice of a philosophical thought is so soft that the noise of spoken words is enough to drown it and prevent it from being heard, if one is questioned and has to speak.)

Page 80

454. Plato: "--What? he said, *it* be of no use? If wisdom is the knowledge of knowledge and is prior to other knowledges, then it must also be prior to that knowledge which relates to the good and in that way must be of use to us.--Does *it* make us healthy, I said, and not medicine? And similarly with the rest of the arts; does *it* direct their business, and not rather each of them its own? Again, have we not long since allowed that it would only be the knowledge of knowledges and ignorances and not of any other matter?--We have indeed.--So it will not produce health in us?--Presumably not.--Because health belongs to a different art?--Yes--Then, friend, neither will it produce utility for us. For this is a business we have too assigned to another art.--Of course--So how can wisdom be useful, if it does not bring us any utility?"†2

Page 80

455. (The philosopher is not a citizen of any community of ideas. That is what makes him into a philosopher.)

Page Break 81

Page 81

456. Some philosophers (or whatever you like to call them) suffer from what may be called "loss of problems". Then everything seems quite simple to them, no deep problems seem to exist any more, the world becomes broad and flat and loses all depth, and what they write becomes immeasurably shallow and trivial. Russell and H. G. Wells suffer from this.

457. ...quia plus loquitur inquisitio quam inventio... (Augustine.)†1

458. Philosophical investigations: conceptual investigations. The essential thing about metaphysics: it obliterates the distinction between factual and conceptual investigations.

459. The fundamental thing expressed grammatically: What about the sentence: "One cannot step into the same river twice"?

460. In a certain sense one cannot take too much care in handling philosophical mistakes, they contain so much truth.†2

"Such irritations are wont to stimulate the powers of thought." How does thought remedy an irritation?

461. I should like you to say: "Yes, it's true, that can be imagined, that may even have happened!" But was I trying to draw your attention to the fact that you are able to imagine this? I wanted to put this picture before your eyes, and your *acceptance* of this picture consists in your being inclined to regard a given case differently; that is, to compare it with *this* series of pictures. I have changed your *way of seeing*. (I once read somewhere that a geometrical figure, with the words "Look at this", serves as a proof for certain Indian mathematicians. This looking too effects an alteration in one's way of seeing.)†3

462. (The classifications of philosophers and psychologists: they classify clouds by their shape.)

463. On mathematics: "Your concept is wrong.--However, I cannot illumine the matter by fighting against your words, but only by trying to turn your attention away from certain expressions, illustrations, images, and *towards* the *employment* of the words."

Page Break 82

464. The pedigree of psychological concepts: I strive *not* after *exactness*, but after a synoptic view.

465. The treatment of all these phenomena of mental life is not of importance to me because I am keen on completeness. Rather because each one casts light on the correct treatment of *all*.

466. And here what is in question is not symptoms, but logical criteria. That these are not always sharply differentiated does not prevent them from being differentiated.

467. Our investigation does not try to *find* the real, exact meaning of words; though we do often *give* words exact meanings in the course of our investigation.

468. "Man thinks, is afraid etc. etc.": that is the reply one might give to someone who asked what chapters a book on psychology should contain.

469. Imagine someone saying: "Man hopes". How should this general phenomenon of natural history be described?--One might observe a child and wait until one day he manifests hope; and then one could say "Today he hoped for the first time". But surely that sounds queer! Although it would be quite natural to say "Today he said 'I hope' for the first time". And why queer?--One does not say that a suckling hopes that.... nor yet that he has no hope that.... and one does say it of a grown man--Well, bit by bit daily life becomes such that there is a place for hope in it.

But now it is said: We can't be certain when a child really begins to hope, for hope is an inner process. What nonsense! For then how do we know what we are talking about at all?

470. Or might he offer *this* example: "I, e.g., see, am not blind"? Even that sounds queer.

It would be correct to say: "You can observe the phenomena *of* thinking, hoping, seeing, etc., in *my* case as well".

471. The psychological verbs to see, to believe, to think, to wish, do not signify phenomena [appearances]. But

psychology observes the phenomena *of* seeing, believing, thinking, wishing.

Page Break 83

Page 83

472. Plan for the treatment of psychological concepts.

Psychological verbs characterized by the fact that the third person of the present is to be verified by observation, the first person not.

Sentences in the third person present: information. In the first person present: expression. ((Not quite right.))

The first person of the present akin to an expression.

Sensations: their inner connexions and analogies.

All have genuine duration. Possibility of giving the beginning and the end. Possibility of their being synchronized, of simultaneous occurrence.

All have degrees and qualitative mixtures. Degree: scarcely perceptible--unendurable.

In this sense there is not a sensation of position or movement. Place of feeling in the body: differentiates seeing and hearing from sense of pressure, temperature, taste and pain.

Page 83

473. We need to reflect that a state of language is possible (and presumably has existed) in which it does not possess the general concept of sensation, but does have words corresponding to our "see", "hear", "taste".

Page 83

474. We call seeing, hearing,... sense-perception. There are analogies and connexions between these concepts; these are our justification for so taking them together.

Page 83

475. It can, then, be asked: what kind of connexions and analogies exist between seeing and hearing? Between seeing and touching? Between seeing and smelling? Etc.

Page 83

476. And if we ask this, then the senses at once shift further apart from one another than they seemed to be at first sight.

Page 83

477. What is common to sense-experiences?--The answer that they give us knowledge of the external world is partly wrong and partly right. It is right in so far as it is supposed to point to a *logical* criterion.

Page 83

478. The duration of sensation. Compare the duration of a sense-experience of sound with the duration of the sensation of touch which informs you that you have a ball in your hand; and with the "feeling" that informs you that your knees are bent.

Page Break 84

Page 84

479. We feel our movements. Yes, we really *feel* them; the sensation is similar, not to a sensation of taste or heat, but to one of touch: to the sensation when skin and muscles are squeezed, pulled, displaced.

Page 84

480. I feel my arm and in a queer way I should now like to say: I feel it in a definite position in space; as if the feeling of my body in a space were disposed in the shape of an arm, so that in order to represent it I should have to model my arm, in plaster say, in the right position.

Page 84

481. It is queer. My lower arm is now resting horizontally, and I should like to say that I feel it; not, however, as if I had a feeling that always accompanies this position (as one would feel ischaemia or engorgement)--but as if the 'body-feeling' of the arm were arranged or disposed horizontally as e.g. a vapour or dust-particles on the surface of my arm are so disposed in space. So it is not really as if I felt the position of my arm, but as if I felt my *arm*, and the feeling had such-and-such a *position*. But that means only: I simply *know* how it is--without knowing it *because*.... Just as I also know where I feel pain--but do not know it *because*....

Page 84

482. It positively seems to us as if pain had a body, as if it were a thing, a body with shape and colour. Why? Has it the shape of the part of the body that hurts? One would like to say for example "I could *describe* the pain if I only had the necessary words and elementary meanings". One feels: all that is lacking is the requisite nomenclature. (James). As if one could even paint the sensation, if only other people would understand this language.--And one really can describe pain spatially and temporally.

Page 84

483. (If sensations are characteristic of the position and movements of the limbs, at any rate their place is not the joint.)

One *knows* the position of one's limbs and their movements. One can give them if asked, for example. Just as one also knows the place of a sensation (pain) in the body.

Reaction of touching the painful place.

Page Break 85

Page 85

No local sign about the sensation. Any more than a temporal sign about a memory-image. (Temporal signs in a photograph.)

Pain differentiated from other sensations by a characteristic expression. This makes it akin to joy (which is not a sense-experience).

Page 85

484. Is it hair-splitting to say:--joy, enjoyment, delight, are not sensations?--Let us at least ask ourselves: How much analogy is there between delight and what we call e.g. "sensation"?

Page 85

485. The connecting link between them would be pain. For this concept resembles that of e.g. tactile sensation (through the characteristics of localisation, genuine duration, intensity, quality) and at the same time that of the emotions through its expression (facial expressions, gestures, noises).

Page 85

486. "I feel great joy"--Where?--that sounds like nonsense. And yet one does say "I feel a joyful agitation in my breast".--But why is joy not localized? Is it because it is distributed over the whole body? Even where the feeling that arouses joy is localized, joy is not: if for example we rejoice in the smell of a flower.--Joy is manifested in facial expression, in behaviour. (But we do not say that we are joyful in our faces).

Page 85

487. "But I do have a real *feeling* of joy!" Yes, when you are glad you really are glad. And of course joy is not joyful behaviour, nor yet a feeling round the corners of the mouth and the eyes.

"But 'joy' surely designates an inward thing." No. "Joy" designates nothing at all. Neither any inward nor any outward thing.

Page 85

488. Continuation of the classification of psychological concepts.

Page 85

Emotions. Common to them: genuine duration, a course. (Rage flares up, abates, vanishes, and likewise joy, depression, fear.)

Distinction from sensations: they are not localized (nor yet diffuse!).

Common: they have characteristic expression-behaviour. (Facial expression.) And this itself implies characteristic sensations too. Thus sorrow often goes with weeping, and characteristic

Page Break 86

sensations with the latter. (The voice heavy with tears). But these sensations are not the emotions. (In the sense in which the numeral 2 is not the number 2).

Among emotions the directed might be distinguished from the undirected. Fear *at* something, joy *over* something.

This something is the object, not the cause of the emotion.

Page 86

489. The language game "I am afraid" already contains the object.

"Anxiety" is what undirected fear might be called, in so far as its manifestations resemble or are the same as those of fear.

The *content* of an emotion--here one imagines something like a *picture*, or something of which a picture can be made. (The darkness of depression which descends on a man, the flames of anger.)

Page 86

490. The human face too might be called such a picture and its alterations might represent the *course* of a passion.

Page 86

491. What goes to make them different from sensations: they do not give us any information about the external world. (A grammatical remark.)

Love and hate might be called emotional dispositions, and so might fear in one sense.

Page 86

492. It is one thing to feel acute fear, and another to have a 'chronic' fear of someone. But fear is not a sensation.

'Horrible fear': is it the *sensations* that are so horrible?

Typical causes of pain on the one hand, and of depression, sorrow, joy on the other. Cause of these also their object.

Pain-behaviour and the behaviour of sorrow.--These can only be described along with their external occasions. (If a child's mother leaves it alone it may cry because it is sad; if it falls down, from pain.) Behaviour and kind of occasion belong together.

Page 86

493. Thoughts may be fearful, hopeful, joyful, angry, etc.

Page Break 87

Page 87

494. Emotions are expressed in thoughts. A man talks angrily, timidly, sadly, joyfully etc., not lumbagoishly.

A thought rouses emotions in me (fear, sorrow etc.) not bodily pain.

Page 87

495. I should almost like to say: One no more feels sorrow in one's body than one feels seeing in one's eyes.

Page 87

496. ((The horribleness of fear is not in the sensations of fear.)) This matter also calls to mind hearing a sound *from a particular direction*. It is almost as if one felt the heaviness around the stomach, the constraint of breath, from the direction of the fear. That means really that "I am sick with fear" does not assign a *cause* of fear.

Page 87

497. "Where do you feel grief?"--In the mind.--What kind of consequences do we draw from this assignment of place? One is that we do *not* speak of a bodily place of grief. Yet we *do* point to our body, as if the grief were in it. Is that because we feel a bodily discomfort? I do not know the cause. But why should I assume it is a bodily discomfort?

Page 87

498. Consider the following question: Can a pain be thought of, say with the quality of rheumatic pain, but *unlocalized*? Can one *imagine* this?

If you begin to think this over, you see how much you would like to change the knowledge of the place of pain into a characteristic of *what is felt*, into a characteristic of a sense-datum, of the private object that I have before my mind.

Page 87

499. If fear is frightful and if while it goes on I am conscious of my breathing and of a tension in my facial muscles--is that to say that I find *these feelings* frightful? Might they not even be a mitigation? ((Dostoevsky)).

Page 87

500. Why does one use the word "suffering" for pain as well as for fear? Well, there are plenty of tie-ups.--

Page 87

501. To the utterance: "I can't think of it without fear" one replies: "There's no reason for fear, for..." That is at any rate *one* way of dismissing fear. Contrast with pain.

Page Break 88

Page 88

502. That there is a fear-syndrome of sensations, thoughts etc. (for example) does not mean that fear is a syndrome.

Page 88

503. If someone acts grief in the study, he will indeed readily become aware of the tensions in his face. But be really sad, or follow a sorrowful action in a film, and ask yourself if you were aware of your face.

Page 88

504. Love is not a feeling. Love is put to the test, pain not. One does not say: "That was not true pain, or it would not have gone off so quickly".

Page 88

505. One connexion between moods and sense-impressions is that we use mood-concepts to describe sense-impressions and images. We say of a theme, a landscape, that it is sad, glad etc. But much more important, of course, is our using all the mood-concepts to describe human faces, actions, behaviours.

Page 88

506. A friendly mouth, friendly eyes. How would one think of a friendly hand?--Probably open and not as a fist.--And could one think of the colour of a man's hair as an expression of friendliness or the opposite?--But put like that the question seems to be whether we can *manage* to. The question ought to run: Do we want to call anything a

friendly or unfriendly hair-colour? If we wanted to give such words a sense, we should perhaps imagine a man whose hair darkened when he got angry. The reading of an angry expression into dark hair, however, would work *via* a previously existent conception.

It may be said: The friendly eyes, the friendly mouth, the wagging of a dog's tail, are among the primary and mutually independent symbols of friendliness; I mean: they are parts of the phenomena that are called friendliness. If one wants to imagine further appearances as expressions of friendliness, one reads these symbols into them. We say: "He has a black look", perhaps because the eyes are more strongly shadowed by the eyebrows; and now we transfer the idea of darkness to the colour of the hair.

Page Break 89

Page 89

507. If anyone asks whether pleasure is a sensation, he probably does not distinguish between reason and cause, for otherwise it would occur to him that one takes pleasure *in something*, which does not mean that this something produces a sensation in us.

Page 89

508. But pleasure does at any rate go with a facial expression; and while we do not see that in ourselves, all the same we notice it.

Page 89

And just try to think over something very sad with an expression of radiant joy!

Page 89

509. It is quite possible that the glands of a sad person secrete differently from those of someone who is glad; and also that their secretion is the or a cause of sadness. But does it follow that the sadness is a *sensation* produced by this secretion?

Page 89

510. But here the thought is: "After all, you *feel* sadness--so you must feel it *somewhere*; otherwise it would be a chimera". But if you want to think that, remember the difference between seeing and pain. I feel pain in the wound--but colour in the eye? If we try to use a schema here, instead of merely noting what is really common, we see everything falsely simplified.

Page 89

511. But if one wanted to find an analogy to the place of pain, it would of course not be the mind (as, of course, the place of bodily pain is not the body) but the *object* of regret.

Page 89

512. Suppose it were said: Gladness is a feeling, and sadness consists in *not* being glad.--Is the absence of a feeling a feeling?

Page 89

513. One speaks of a feeling of conviction because there is a *tone* of conviction. For the characteristic mark of all 'feelings' is that there is expression of them, i.e. facial expression, gestures, of feeling.

Page 89

514. Now one might say this: A man's face has by no means a constant appearance. It alters from one moment to the next; sometimes only a little, sometimes up to the point of unrecognizability. Nevertheless it is possible to draw a picture of his physiognomy. Of course a picture in which the face smiles does

Page Break 90

not shew how it looks when weeping. But it does permit inferences.--And in this way it would also be possible to describe a kind of average physiognomy of belief (e.g.).

Page 90

515. I give signs of delight and comprehension.

Page 90

516. Can 'knowing one's way about' be called an experience? Surely not. But there are experiences characteristic of the condition of knowing one's way about and not knowing one's way about. (Not knowing one's way about and lying.)

Page 90

517. But it is surely important that all these paraphrases exist. That care can be described in such words as: "the descent of a permanent cloud". I have perhaps never stressed the importance of this paraphrasing enough.

Page 90

518. Why can a dog feel fear but not remorse? Would it be right to say "Because he can't talk"?

Page 90

519. Only someone who can reflect on the past can repent. But that does not mean that as a matter of empirical fact only such a one is capable of the feeling of remorse.

Page 90

520. There is nothing astonishing about certain concepts' only being applicable to a being that e.g. possesses a language.

Page 90

521. "The dog *means* something by wagging his tail."--What grounds would one give for saying this?--Does one also say: "By drooping its leaves, the plant means that it needs water"?--

Page 90

522. We should hardly ask if the crocodile means something when it comes at a man with open jaws. And we should declare that since the crocodile cannot think there is really no question of meaning here.

Page 90

523. Let us just forget entirely that we are interested in the state of mind of a frightened man. It is certain that under given circumstances we may also be interested in his behaviour as an indication of how he will behave in the future. So why should we not have a word for this?

Page Break 91

Page 91

It might now be asked whether this word would really relate simply to behaviour, simply to bodily changes. And this may be denied. There is no future in simplifying the use of this word in this way. It relates to the behaviour under certain external circumstances. If we observe these circumstances and that behaviour we say that a man is... or has....

Page 91

524. There might be a concept of fear that had application only to beasts, and hence only through observation.--But you don't want to say that such a concept would have no use. The verb that would roughly correspond to the word "to fear" would then have no first person and none of its forms would be an expression of fear.

Page 91

525. I now want to say that humans who employ such a concept would *not* have to be able to describe its use. And were they to try, it is possible that they would give a quite inadequate description. (Like most people, if they tried to describe the use of money correctly). (They are not prepared for such a task).

Page 91

526. If someone behaves in such-and-such a way under such-and-such circumstances, we say that he is sad. (We say it of a dog too). To this extent it cannot be said that the behaviour is the *cause* of the sadness: it is its symptom. Nor would it be beyond cavil to call it the effect of sadness.--If he says it of himself (that he is sad) he will not in general give his sad face as a reason. But what about this: "Experience has taught me that I get sad as soon as I start sitting about sadly, etc." This might have two different meanings. Firstly: "As soon as, following a slight inclination, I set out to carry and conduct myself in such-and-such a way, I get into a state in which I have to persist in this behaviour". For it might be that toothache got worse by groaning.--Secondly, however, that proposition might contain a speculation about the cause of human sadness; the content being that if you could somehow or other produce certain bodily states, you would make the man sad. But here arises the difficulty that we should not call a man sad, if he *looked* and *acted* sad in all circumstances. If we taught such a one the expression "I am sad" and he constantly kept on saying this with an expression of sadness, these words, like the other signs, would have lost their normal sense.

Page Break 92

Page 92

527. Isn't it as if one were trying to imagine a facial expression not susceptible of alterations which were gradual and difficult to catch hold of, but which had, say, just five positions; when it changed it would snap straight from one to another. Now would this fixed smile, for example, really be a smile? And why not?--"Smiling" is our name for an expression in a normal play of expressions.--I might not be able to react as I do to a smile. It would e.g. not make me smile myself. One wants to say: "No wonder we have this concept in *these* circumstances".

Page 92

528. An auxiliary construction. A tribe that we want to enslave. The government and the scientists give it out that the people of this tribe have no souls; so they can be used for any arbitrary purpose. Naturally we are interested in their language nevertheless; for we certainly want to give them orders and to get reports from them. We also want to know what they say to one another, as this ties up with the rest of their behaviour. But we must also be interested in what corresponds in them to our '*psychological utterances*', since we want to keep them fit for work; for that reason

their manifestations of pain, of being unwell, of depression, of joy in life, are important to us. We have even found that it has good results to use these people as experimental subjects in physiological and psychological laboratories, since their reactions--including their linguistic reactions--are quite those of mind-endowed human beings. Let it also have been found out that these automata can have our language imparted to them instead of their own by a method which is very like our 'instruction'.

Page 92

529. These creatures now learn e.g. to calculate, they learn paper or oral calculation. But by some method we make them able to give the result of a multiplication after behaving in a 'reflective' manner for a time, though without writing or speaking. If one considers the kind of way they learn this 'calculating in the head', together with the surrounding phenomena, this suggests the picture of the process of calculating as, so to speak, submerged and going on *under* the surface.

Of course for various purposes we need an order like "Work this out in your head"; a question like "Have you worked it out?"; and even "How far have you got?"; a statement "I have worked

Page Break 93

... out" on the part of the automaton; etc. In short: everything that *we* say among ourselves about calculating in the head is of interest to us when they say it. And what goes for calculating in the head goes for all other forms of thinking as well.--If one of us gives vent to the opinion that these beings *must* after all have some kind of mind, we jeer at him.

Page 93

530. The slaves also say: "When I heard the word 'bank' it meant... to me." Question: *what* technique of using language is the background for their saying this? For everything depends on that. What have we taught them, what use for the word "mean"? And what, if anything at all, do we gather from their utterance? For if we can do nothing with it, still it might interest us as a curiosity.--Let us imagine a tribe of men, unacquainted with dreams, who hear our narrations of dreams. One of us had come to these non-dreaming people and learnt bit by bit to make himself understood to them.--Perhaps one thinks they would never understand the word "to dream". But they would soon find a use for it. And their doctors might very well be interested in the phenomenon and might make important inferences from the dreams of the stranger.--Nor can it be said that for these people the verb "to dream" could mean nothing but: to tell a dream. For the stranger would of course use both expressions, both "to dream" and "to tell a dream", and the people of that tribe would not be allowed to confuse "I dreamt..." with "I told the dream...."

Page 93

531. "I assume that a picture swims before him".--Could I also assume that a picture swims before this stove?--And why does this seem impossible? Is the human shape necessary for this?--

Page 93

532. The concept of pain is characterized by its particular function in our life.

Page 93

533. Pain has *this* position in our life; has *these* connexions; (That is to say: we only call "pain" what has *this* position, *these* connexions).

Page 93

534. Only surrounded by certain normal manifestations of life, is there such a thing as an expression of pain. Only surrounded

Page Break 94

by an even more far-reaching particular manifestation of life, such a thing as the expression of sorrow or affection. And so on.

Page 94

535. If I, and if anyone else, can imagine a pain, or at least we say we can--how is it to be found out whether we are imagining it right, and how accurately we are imagining it?

Page 94

536. I may know that he is in pain, but I never know the exact degree of his pain. So here is something that he knows and that his expression of pain does not tell me. Something purely private.

He knows exactly how severe his pain is? (Isn't that much as if one were to say he always knows exactly where he is? Namely *here*.) Is the concept of the degree given with the pain?

Page 94

537. You say you attend to a man who groans because experience has taught you that you yourself groan when you feel such-and-such. But as you don't in fact make any such inference, we can abandon the justification by analogy.

Page 94

538. Nor does it make sense to say: "I don't bother about my own groaning because *I know* that I am in pain"--or "because I *feel* my pain".

Yet this is perfectly true:--"I don't bother about my groaning".

Page 94

539. I infer that he needs to go to the doctor from observation of his behaviour; but I do *not* make this inference in my own case from observation of my behaviour. Or rather: I do this too sometimes, but *not* in parallel cases.

Page 94

540. It is a help here to remember that it is a primitive reaction to tend, to treat, the part that hurts when someone else is in pain; and not merely when oneself is--and so to pay attention to other people's pain-behaviour, as one does *not* pay attention to one's own pain behaviour.

Page 94

541. But what is the word "primitive" meant to say here? Presumably that this sort of behaviour is *pre-linguistic*: that a language-game is based *on it*, that it is the prototype of a way of thinking and not the result of thought.

Page Break 95

Page 95

542. "Putting the cart before the horse" may be said of an explanation like the following: we tend someone else because by analogy with our own case we believe that he is experiencing pain too.--Instead of saying: Get to know a new aspect from this special chapter of human behaviour--from this use of language.

Page 95

543. My relation to the appearances here is part of my concept.

Page 95

544. When we tell a doctor that we have been having pains--in what cases is it useful for him to imagine pain?--And doesn't this happen in a variety of ways? (As great a variety as: recalling pain). (Knowing what a man looks like).

Page 95

545. Suppose someone explains how a child learns the use of the word "pain" in the following way: When the child behaves in such-and-such a way on particular occasions, I think he's feeling what I feel in such cases; and if it is so then the child associates the word with his feeling and uses the word when the feeling reappears.--*What* does this explanation explain? Ask yourself: *What* sort of ignorance does it remove?--Being sure that someone is in pain, doubting whether he is, and so on, are so many natural, instinctive, kinds of behaviour towards other human beings, and our language is merely an auxiliary to, and further extension of, this relation. Our language-game is an extension of primitive behaviour. (For our *language-game* is behaviour.) (Instinct).

Page 95

546. "I am not certain whether he is in pain."--Suppose now someone always pricked himself with a pin when he said this, in order to have the meaning of the word "pain" vividly before his mind (so as not to have to rest content with imagination) and to know *what* he is in doubt of about the other man.--Would the sense of his statement now be assured?

Page 95

547. So he is having genuine pain, and it is the possession of *this* by someone else that he feels doubt of.--But how does he do this?--It is as if I were told: "Here is a chair. Can you see it clearly?--Good--now translate it into French!"

Page Break 96

Page 96

548. So he has real pain; and now he knows what he is to doubt in someone else's case. He has the object before him and it is *not* some piece of behaviour or the like. (But now!) In order to doubt whether someone else is in pain he needs, not pain, but the *concept* 'pain'.

Page 96

549. To call the expression of a sensation a *statement* is misleading because 'testing', 'justification', 'confirmation', 'reinforcement' of the statement are connected with the word "statement" in the language-game.

Page 96

550. What purpose is served by the statement: "I do *have* something, if I have a pain"?

Page 96

551. "The smell is marvellous!" Is there a doubt whether it is the smell that is marvellous?

Is it a property of the smell?--Why not? It is a property of ten to be divisible by two and also to be the number of my fingers.

There might however be a language in which the people merely shut their eyes and say "Oh, this smell!" and there is no subject-predicate sentence equivalent to it. That is simply a 'specific' reaction.

552. It's not merely the picture of the behaviour that belongs to the language-game with the words "he is in pain"--one would like to say--but also the picture of the pain.--But here one must take care: think of my example of the private tables that don't belong to the *game*.--The impression of a 'private table' in the game arises through the *absence* of a table and through the similarity of the game to one that is played with a table.†1

553. Remember: we often use the phrase "I don't know" in a queer way; when for example we say that we don't know whether this man really feels more than that other, or merely gives stronger expression to his feeling. In that case it is not clear what sort of investigation might settle the question. Of course the expression is not quite idle: we want to say that we certainly can compare the feelings of A and B with one another, but that the circumstances of a comparison of A with C throw us out.

554. That the evidence makes someone else's feeling ((i.e. what is within)) *merely* probable is not what matters to us; what we are looking at is the fact that *this* is taken as *evidence* for something (important); that we base a judgment on *this* involved sort of evidence, and hence that *such* evidence has a special importance in our lives and is made prominent by a concept. ((The 'inner' and the 'outer', a *picture*)).

555. The 'uncertainty' relates not to the particular case, but to the method, to the rules of evidence.

556. The uncertainty is not founded on the fact that he does not wear his pain on his sleeve. And there is not an uncertainty *in each particular case*. If the frontier between two counties were in dispute, would it follow that the county to which any individual resident belonged was dubious?

557. Imagine that people could observe the functioning of the nervous system in others. In that case they would have a sure way of distinguishing genuine and simulated feeling.--Or might they after all doubt in turn whether someone feels anything when these signs are present?--What they see there could at any rate readily be imagined to determine their reaction without their having any qualms about it.

And now this can be transferred to outward behaviour.

This observation fully determines their attitude to others and doubt does not occur.

558. There is indeed the case where someone later reveals his inmost heart to me by a confession: but that this is so cannot offer me any explanation of outer and inner, for I have to give credence to the confession.

For confession is of course something exterior.

559. Look at people who doubt even in these circumstances, and at ones who do not doubt.

560. Only God sees the most secret thoughts. But why should these be all that important? Some are important, not all. And need all human beings count them as important?

561. *One* kind of uncertainty is that with which we might face an unfamiliar mechanism. In another we should possibly be recalling an occasion in our life. It might be e.g. that someone who has just escaped the fear of death would shrink from swatting a fly, though he would otherwise do it without thinking twice about it. Or on the other hand that, having this experience in his mind's eye, he does with hesitancy what otherwise he does unhesitatingly.

562. Even when I 'do not rest secure in my sympathy' I need not think of uncertainty about his later behaviour.

563. The one uncertainty stems from you, so to speak, the other from him.

The one could surely be said to connect up with an analogy, then, but not the other. Not, however, as if I were drawing a conclusion from the analogy!

564. If however I doubt whether a spider feels pain, it is not because I don't know what to expect.

565. But we cannot get away from forming the picture of a mental process. And *not* because we are acquainted with it in our own case!

Page 98

566. Might not the attitude, the behaviour, of trusting, be quite universal among a group of humans? So that a doubt about manifestations of feeling is quite foreign to them?†1

Page 98

567. How could human behaviour be described? Surely only by sketching the actions of a variety of humans, as they are all mixed up together. What determines our judgment, our concepts and reactions, is not what *one* man is doing *now*, an individual action, but the whole hurly-burly of human actions, the background against which we see any action.

Page 98

568. Seeing life as a weave, this pattern (pretence, say) is not always complete and is varied in a multiplicity of ways. But we, in our conceptual world, keep on seeing the same, recurring with variations. That is how our concepts take it. For concepts are not for use on a single occasion.†2

Page Break 99

Page 99

569. And one pattern in the weave is interwoven with many others.

Page 99

570. "One *can't* pretend like that".--This may be a matter of experience--namely that no one who behaves like *that* will later behave in such-and-such a way; but it also may be a conceptual stipulation ("That wouldn't still be pretence"); and the two may be connected.

That can no longer be called "pretence".

(For it wouldn't have been said that the planets *had* to move in circles, if it had not appeared *that* they move in circles).

((Compare: "One cannot talk like that without thinking", "One cannot act like that involuntarily")).

Page 99

571. Couldn't you imagine a further surrounding in which this too could be interpreted as pretence? Must not any behaviour allow of such an interpretation?

But what does it mean to say that all behaviour *might* always be pretence? Has experience taught us this? How else can we be instructed about pretence? No, it is a remark about the concept 'pretence'. But then this concept would be unusable, for pretending would have no criteria in behaviour.

Page 99

572. Isn't there something here like the relation between Euclidean geometry and the experience of the senses? (I mean that there is a profound resemblance here). For Euclidean geometry too corresponds to experience only in some way that is not at all easy to understand, not merely as something more exact to its less exact counterpart.

Page 99

573. There is such a thing as trust and mistrust in behaviour!

If anyone complains, e.g., I may be trustful and react with perfect confidence, or I may be uncertain, like someone who has his suspicions. Neither words nor thoughts are needed for this.

Page 99

574. Is what he says he has, and I say I have, without our inferring this from any sort of observation--is it the same as what we gather from observing the behaviour of someone else and from his *expressions* of conviction?

Page Break 100

Page 100

575. Can it be said that I *infer* that he will act as *he intends* to act? ((Case of the wrong gesture)).

Page 100

576. Why do I never infer my probable actions from my words? For the same reason as I do not infer my probable behaviour from my facial expression.--For the interesting thing is not that I do not infer my emotion from my expression of emotion, but that I also do not infer my later behaviour from that expression, as other people do, who observe me.

Page 100

577. What is voluntary is certain movements with their normal *surrounding* of intention, learning, trying, acting. Movements of which it makes sense to say that they are sometimes voluntary and sometimes involuntary are movements in a special surrounding.

Page 100

578. If someone were now to tell us that *he* eats involuntarily--what evidence would make one believe this?

Page 100

579. One produces a sneeze or a fit of coughing in oneself, but not a voluntary movement. And the will does not produce sneezing, nor yet walking.

Page 100

580. My expression†1 came from my thinking of willing as a sort of producing--not however as a case of causation, but--I should like to say--as a direct, non-causal producing. And the basis of this idea is our imagining that the causal nexus is the connexion of two machine parts by means of a mechanism, say a train of cogwheels.

Page 100

581. Is "I am doing my utmost" the expression of an experience?--One difference: one says "Do your utmost".

Page 100

582. If someone meets me in the street and asks "Where are you going?" and I reply "I don't know", he assumes I have no definite *intention*; not that I do not know whether I shall be able to carry out my intention. (Hebel.)†2

Page Break 101

Page 101

583. What is the difference between these two things: Following a line involuntarily--Following a line intentionally?

What is the difference between these two things: Tracing a line with care and great attention--Attentively observing how my hand follows a line?

Page 101

584. Certain differences are easy to give. One lies in foreseeing what the hand will do.

Page 101

585. The experience of getting to know a new experience. E.g. in writing. When does one say one has become acquainted with a new experience? How does one use such a proposition?

Page 101

586. Writing is certainly a voluntary movement, and yet an automatic one. And of course there is no question of a feeling of each movement in writing. One feels something, but could not possibly analyse the feeling. One's hand writes; it does not write because one wills, but one wills what it writes.

One does not watch it in astonishment or with interest while writing; does not think "What will it write now?" But not because one had a wish it should write *that*. For that it writes what I want might very well throw me into astonishment.

Page 101

587. A child learns to walk, to crawl, to play. It does not learn to play voluntarily and involuntarily. But what makes its movements in play into voluntary movements?--What would it be like if they were involuntary?--Equally, I might ask: what makes this movement into a game?--Its character and its surroundings.

Page 101

588. Active and passive. Can one give an order to do it or not? This perhaps seems, but is not, a far-fetched distinction. It is like: "Can one (*logical* possibility) decide to do it or not?"--And that means: How is it surrounded by thoughts, feelings, etc.?

Page 101

589. "When I make an effort, I surely *do* something, I don't merely have a sensation". And that is so; for one tells someone "Make an effort" and he may express his intention: "Now I will make an effort". And if he says "I can't keep it up"--that does not mean "I can't put up with the feeling in my limbs"--e.g. of

Page Break 102

pain.--On the other hand, however, one *suffers* from making an effort as from pain. "I am completely exhausted"--if someone said that, but moved as briskly as ever, we should not understand him.

Page 102

590. The connexion of our main problem with the epistemological problem of willing has occurred to me before. When such an obstinate problem makes its appearance in psychology, it is never a question about facts of experience (such a problem is always much more tractable), but a logical, and hence properly a grammatical question.

Page 102

591. My own behaviour is sometimes--but *rarely*--the object of my own observation. And this is connected with the fact that I intend my behaviour. Even if an actor observes his own expressions in a glass, or a musician pays close

attention to every note he plays and judges it, this is done so as to direct his action accordingly.

Page 102

592. What does it mean to say e.g. that self-observation makes my action, my movements, uncertain?

I cannot observe myself unobserved. And I do not observe myself for the same purpose as I do someone else.

Page 102

593. If a child stamps and roars with fury--who would say it was doing so involuntarily? And why? Why does one assume it not to be doing this involuntarily? What are the *tokens* of involuntary action? Are there such tokens?--Then what are the tokens of involuntary movement? It does not obey orders, as voluntary movement does. We have "Come here", "Go over there", "Make this arm-movement"; but not "Make your heart beat".

Page 102

594. There is a particular interplay of movements, words, expressions of face, as of manifestations of reluctance or readiness, which are characteristic of the voluntary movements of a normal human being. If one calls a child, he does not come automatically: there is e.g. the gesture "I don't want to!" Or coming cheerfully, the decision to come, running away with signs of fear, the effects of being addressed, all the reactions of the game, the signs and the effects of consideration.

Page Break 103

Page 103

595. How could I prove to myself that I can move my arm voluntarily? Say by telling myself: "Now I will move it" after which it moves? Or should I say "Simply by moving it"? But how do I know that I did it, and that it did not move just by accident? Do I in the end feel it after all? And suppose my memory of previous feelings were to deceive me and these were not the right feelings to go by! (And which are the right ones?) And how does someone else know whether *I* have moved my arm voluntarily? Perhaps I shall say to him "Order me to make whatever movement you like and, to convince you, I will do it".--And what do you feel in your arm? "Well, the usual feeling". There is nothing unusual about the feelings--the arm isn't without feeling, for example (as if it had 'gone to sleep').

Page 103

596. If I do not know that a movement of my body is taking place or has taken place, that movement will be called involuntary.--But how about when I merely *try* to lift a weight, and so there is a movement that does not take place? What would it be like if someone involuntarily strained to lift a weight? In what circumstances would one call *this* behaviour 'involuntary'?

Page 103

597. May not rest be just as voluntary as motion? May not the cessation of movement be voluntary? What better argument against a feeling of innervation?

Page 103

598. What a queer concept 'to attempt', 'to try', is: what can one not 'try to do'! (One tries to remember, to lift a weight, to attend, to think of nothing). But then it might also be said: What a remarkable concept 'doing' is! What are the relations of affinity between 'talking' and 'thinking', between 'speaking' and 'speaking inwardly'? (Compare the relation of affinity between the kinds of numbers).

Page 103

599. One draws quite different conclusions from an involuntary movement and from a voluntary: this *characterizes* voluntary movement.

Page 103

600. But how do I know that this movement was voluntary?--I don't know this, I manifest it.

Page Break 104

Page 104

601. "I am pulling as hard as I can". How do I know that? Does the feeling in my muscles tell me so? The words are a signal; and they have a *function*.

But then, don't I *experience* anything? Do I experience something, then? Something specific? A specific feeling of straining and not-being-able-to-do-anymore, of reaching the limit? Of course, but these expressions say no more than "I am pulling as hard as I can".

Page 104

602. Compare this case: Someone is to say what he feels when a weight is resting on his flat hand. Now I can imagine a split here: On the one hand he tells himself that what he feels is a pressure against the surface of his hand and a tension in the muscles of his arm; on the other hand he wants to say: "But that isn't all! I surely feel a pull, a drive downwards on the part of the weight."--Does he then have a sensation of such a 'drive'? Yes: when he thinks of

the 'drive'. With the word 'drive' there goes here a particular picture, a gesture, a tone of voice; and in this you can see the experience of the drive.

(Think also of this: Some people say Such-and-such a person 'gives forth a fluid'--This is the source of the word "*influence*".)

Page 104

603. The unpredictability of human behaviour. But for this--would one still say that one can never know what is going on in anyone else?

Page 104

604. But what would it be like if human behaviour were not unpredictable? How are we to imagine this? (That is to say: how should we depict it in detail, what are the connexions we should assume?)

Page 104

605. One of the most dangerous of ideas for a philosopher is, oddly enough, that we think with our heads or in our heads.

Page 104

606. The idea of thinking as a process in the head, in a completely enclosed space, gives him something occult.

Page 104

607. Is thinking a specific *organic* process of the mind, so to speak--as it were chewing and digesting in the mind? Can we replace it by an inorganic process that fulfils the same end,

Page Break 105

as it were use a prosthetic apparatus for thinking? How should we have to imagine a prosthetic organ of thought?

Page 105

608. No supposition seems to me more natural than that there is no process in the brain correlated with associating or with thinking; so that it would be impossible to read off thought-processes from brain-processes. I mean this: if I talk or write there is, I assume, a system of impulses going out from my brain and correlated with my spoken or written thoughts. But why should the *system* continue further in the direction of the centre? Why should this order not proceed, so to speak, out of chaos? The case would be like the following--certain kinds of plants multiply by seed, so that a seed always produces a plant of the same kind as that from which it was produced--but *nothing* in the seed corresponds to the plant which comes from it; so that it is impossible to infer the properties or structure of the plant from those of the seed that it comes out of--this can only be done from the *history* of the seed. So an organism might come into being even out of something quite amorphous, as it were causelessly; and there is no reason why this should not really hold for our thoughts, and hence for our talking and writing.

Page 105

609. It is thus perfectly possible that certain psychological phenomena *cannot* be investigated physiologically, because physiologically nothing corresponds to them.

Page 105

610. I saw this man years ago: now I have seen him again, I recognize him, I remember his name. And why does there have to be a cause of this remembering in my nervous system? Why must something or other, whatever it may be, be stored up there *in any form*? Why *must* a trace have been left behind? Why should there not be a psychological regularity to which *no* physiological regularity corresponds? If this upsets our concepts of causality then it is high time they were upset.

Page 105

611. The prejudice in favour of psychophysical parallelism is a fruit of primitive interpretations of our concepts. For if one allows a causality between psychological phenomena which is not mediated physiologically, one thinks one is making profession that there exists a soul *side by side* with the body, a ghostly soul-nature.

Page Break 106

Page 106

612. Imagine the following phenomenon. If I want someone to take note of a text that I recite to him, so that he can repeat it to me later, I have to give him paper and pencil; while I am speaking he makes lines, marks, on the paper; if he has to reproduce the text later he follows those marks with his eyes and recites the text. But I assume that what he has jotted down is not *writing*, it is not connected by rules with the words of the text; yet without these jottings he is unable to reproduce the text; and if anything in it is altered, if part of it is destroyed, he sticks in his 'reading' or recites the text uncertainly or carelessly, or cannot find the words at all.--This *can* be imagined!--What I called jottings would not be a *rendering* of the text, not so to speak a translation with another symbolism. The text would not be *stored up* in the jottings. And why should it be stored up in our nervous system?

Page 106

613. Why should there not be a natural law connecting a starting and a finishing state of a system, but not covering the intermediary state? (Only one must not think of *causal efficacy*.)

Page 106

614. "How does it come about that I see the tree standing up straight even if I incline my head to one side, and so the retinal image is that of an obliquely standing tree?" Well, how does it come about that I speak of the tree as standing up straight even in these circumstances?--"Well, I am conscious of the inclination of my head, and so I supply the requisite correction in the way I take my visual impression."--But doesn't that mean confusing what is primary and what is secondary? Imagine that we know *nothing at all* of the inner structure of the eye--would this problem altogether disappear? We do not supply any correction here--that explanation is gratuitous.

Well--but now that the structure of the eye is known--*how does it come about* that we act, react, in this way? But must there be a physiological explanation here? Why don't we just leave explaining alone?--But you would never talk like that, if you were examining the behaviour of a machine!--Well, who says that a living creature, an animal body, is a machine in this sense?--

Page 106

615. (I have never yet read a comment on the fact that when one shuts one eye and "only sees with one eye" one does not

Page Break 107

simultaneously see darkness (blackness) with the one that is shut.)

Page 107

616. The limitlessness of the visual field is clearest when we are seeing nothing in complete darkness.†1

Page 107

617. How is it with a blind man; can one part of *language* not be explained to him? Or rather not be *described*?

Page 107

618. A blind man can say that he is blind and the people around him sighted. "Yes, but doesn't he after all mean something different from a sighted man when he uses the words 'blind' and 'sighted'?" What is the ground of one's inclination to say so? Well, if someone did not know what a leopard looked like, still he could say and understand "That place is very dangerous, there are leopards there". He would perhaps all the same be said not to know what a leopard is, and so not to know, or not completely, what the word "leopard" means, until he is shewn such an animal. Now it strikes us as being the same with the blind. They don't know, so to speak, what seeing is like.--Now is 'not knowing fear' analogous to 'never having seen a leopard'? That, of course, I want to deny.

Page 107

619. Might I not e.g. make the assumption that he sees something red when I hit him on the head? This might correspond to an experience in the case of sighted people.

Assuming this, still he is blind for all practical purposes. That is to say he does not react like a normal human being. If, however, someone were blind of eye, but on the other hand so conducted himself that we were forced to say that he saw with the palms of his hands (this behaviour is easy to work out), we should treat him as sighted and should also find possible the use of a sample slip to explain the word 'red' to him.

Page 107

620. You give someone a signal when you imagine something: you use different signals for different images.--How have you agreed together what each signal is to mean?

Page 107

621. Auditory images, visual images--how are they distinguished from sensations? Not by "vivacity".

Page Break 108

Page 108

Images tell us nothing, either right or wrong, about the external world. (Images are not hallucinations, nor yet fancies).

While I am looking at an object I cannot imagine it.

Difference between the language-games: "Look at this figure!" and: "Imagine this figure!"

Images are subject to the will.

Images are not pictures. I do not tell what object I am imagining by the resemblance between it and the image.

Page 108

Asked "What image have you?" one can answer with a picture.

Page 108

622. One would like to say: The imaged is in a different *space* from the heard sound. (Question: Why?) The seen in a different space from the imaged.

Hearing is connected with listening; forming an image of a sound is not.

That is why the heard sound is in a different space from the imagined sound.

Page 108

623. I read a story and have all sorts of images while I read, i.e. while I am looking attentively, and hence seeing clearly.

Page 108

624. People might exist who never use the expression "seeing something with the inner eye" or anything like it, and these people might be able to draw and model 'out of imagination' or from memory, to mimic others etc. Such a person might also shut his eyes or stare into vacancy as if blind before drawing something from memory. And yet he might deny that he then *sees* before him what he goes on to draw. But what value need I set on this utterance? Should I judge by *it* whether he has a visual image? (Not *it* alone. Think of the expression: "Now I see it before me--now no longer". Here is genuine duration.)

Page 108

625. I might also have said earlier: The *tie-up* between imaging and seeing is close; but there is no *similarity*.

The language-games employing these concepts are radically different--but hang together.

Page Break 109

Page 109

626. Difference between: 'trying to see something' and 'trying to form an image of something'. In the first case one says: "Look, just over there!", in the second "Shut your eyes!"

Page 109

627. It is just because forming images is a voluntary activity that it does not instruct us about the external world.

Page 109

628. What is imaged is not in the same *space* as what is seen. Seeing is connected with looking.

Page 109

629. "Seeing and imaging are different phenomena".--The words "seeing" and "imaging" have different meanings. Their meanings relate to a host of important kinds of human behaviour, to phenomena of human life.

Page 109

630. If someone insists that what he calls a "visual image" is like a visual impression, say to yourself once more that perhaps he is *making a mistake*. Or: Suppose he is making a mistake. That is to say: What do you know about the resemblance of his visual impression and his visual image?! (I speak of others because what goes for them goes for me too).

So what do you know about this resemblance? It is manifested only in the expressions which he is inclined to use; not in something he uses those expressions to say.

Page 109

631. "There's no doubt at all: visual images and visual impressions are of the same kind!" That must be something you know from your own experience; and in that case it is something that may be true for you and not for other people. (And this of course holds for me too, if *I* say it).

Page 109

632. When we form an image of something we are not observing. The coming and going of the pictures is not something that *happens* to us. We are not surprised by these pictures, saying "Look!" (Contrast with e.g. after-images).

Page 109

633. We do not 'banish' visual impressions, as we do images. And we don't say of the former, either, that we might *not* banish them.

Page 109

634. If someone really were to say "I don't know whether I am now seeing a tree or having an image of it", I should at first think he meant: "or just fancying that there is a tree over there".

Page Break 110

If he does not mean this, I couldn't understand him at all--but if someone tried to explain this case to me and said "His images are of such extraordinary vivacity that he can take them for impressions of sense"--should I understand it then?

Page 110

635. But must one not distinguish here: (a) forming the image of a human face, for example, but not in the space that

surrounds me--(b) forming an image of a picture on that wall over there?

At the request "Imagine a round spot over there" one might fancy that one really was seeing one there.

Page 110

636. The 'imagination-picture' does not enter the language-game in the place where one would like to surmise its presence.

Page 110

637. I learn the concept 'seeing' along with the description of what I see. I learn to observe and to describe what I observe. I learn the concept 'to have an image' in a different context. The descriptions of what is seen and what is imaged are indeed of the same kind, and a description might be of the one just as much as of the other; but otherwise the concepts are thoroughly different. The concept of imaging is rather like one of doing than of receiving. Imagining might be called a creative act. (And is of course so called).

Page 110

638. "Yes, but the image itself, like the visual impression, is surely the inner picture, and *you* are talking only of differences in the production, the coming to be, and in the treatment of the picture." The image is not a picture, nor is the visual impression one. Neither 'image' nor 'impression' is the concept of a picture, although in both cases there is a tie-up with a picture, and a different one in either case.

Page 110

639. What do you *call* the "experiential content" of seeing, what the "experiential content" of imaging?

Page 110

640. "But couldn't I imagine an experiential content of the same kind as visual images, but not subject to the will, and so in this respect like visual impressions?"

Page 110

641. (Clearly the voluntary act of forming images cannot be compared with moving the body; for someone else is also competent to judge whether the movement has taken place; whereas with the movement of my images the whole point would always

Page Break 111

be what I said I saw--whatever anyone else sees. So really moving objects would drop out of consideration, since no such thing would be in question).

Page 111

642. If then one said: "Images are inner pictures, resembling or exactly like my visual impressions, only subject to my will"--the first thing is that this doesn't yet make sense.

For if someone has learnt to report what he sees over there, or what *seems* to him to be over there, it surely isn't clear to him what it would mean if he were ordered now to see *this* over there, or now to have *this* seem to him to be over there.

Page 111

643. "To move by pure will"--What does that mean? That the image-pictures always exactly obey my will, whereas my hand in drawing, my pencil, does not? All the same in that case it would be possible to say: "Usually I form images of exactly what I want to; today it has turned out differently". Is there such a thing as 'images not coming off'?

Page 111

644. A language-game comprises the use of *several* words.

Page 111

645. Nothing could be more mistaken than to say: seeing and forming an image are different activities. That is as if one were to say that moving and losing in chess were different activities.

Page 111

646. When we learn as children to use the words "see", "look", "image", voluntary actions and orders play a part in this training. But a different one for each of the three words. The language-game "Look" and "Form an image of..."--how am I ever to compare them?--If we want to train someone to react to the order "Look..." and to understand the order "Form an image of..." we must obviously teach him quite differently. Reactions which belong to the latter language-game do not belong to the former. There is of course a close tie-up of these language-games; but a resemblance?--Bits of one resemble bits of the other, but the resembling bits are not homologous.

Page 111

647. I could imagine something similar for actual games.

Page Break 112

Page 112

648. One language-game analogous to a fragment of another. One space projected into a limited extent of another. A 'gappy' space. (For "inner and outer".)

Page 112

649. Let us imagine a variant of tennis: it is included in the rules of this game that the player has to *form such-and-such* images as he performs certain moves in the game. (Let the purpose of this rule be to make the game more difficult.) The first objection is: it is too easy to cheat in this game. But this is met by the assumption that the game is played only by honest and reliable people. So here we have a game with inner moves of the game.--

What sort of move is the inner move of the game, what does it consist in? In this, that--according to the rule--he forms an image of....--But might it not also be said: *We do not know* what kind of inner move of the game he does perform according to the rule; we only know its manifestations. Let the inner move of the game be an X, whose nature we do not know. Or again: Even here there are only external moves of the game; the communication of the rule and what is called the 'manifestation of the inner process'.--Now may one not describe the game in all three different ways? Even the one with the 'unknown' X is a quite possible kind of description. One man says that the so-called 'inner' move in the game is not comparable with a move in the game in the ordinary sense--the next says it *is* so comparable--and the third: it is comparable only with an action happens in secret and which no one knows but the agent.

It is important for us to see the *dangers* of the expression "inner move of the game". It is dangerous because it produces confusion.

Page 112

650. Memory: "I see us still, sitting at that table".--But have I really the same visual image--or one of those that I had then? Do I also certainly see the table and my friend from the same point of view as then, and so not see myself?--My memory-image is not evidence for that past situation, like a photograph which was taken then and convinces me now that this was how things were then. The memory-image and the memory-words stand on the *same* level.

Page Break 113

Page 113

651. Shrugging of shoulders, head-shakes, nods and so on we call signs first and foremost because they are embedded in the use of our *verbal language*.

Page 113

652. If one takes it as obvious that a man takes pleasure in his own fantasies, let it be remembered that fantasy does not correspond to a painted picture, to a sculpture or a film, but to a complex formation out of heterogeneous components--signs and pictures.

Page 113

653. Some men recall a musical theme by having an image of the score rise before them, and reading it off.

It could be imagined that what we call "memory" in some man consisted in his seeing himself looking things up in a book in spirit, and that what he read in that book was what he remembered. (How do I *react* to a memory?)

Page 113

654. Can a memory-experience be described?--Certainly.--But can what is memory-like about this experience be described? *What does that mean?*--((The indescribable aroma.))

Page 113

655. "A picture (imagination-picture, memory-image) of longing." One thinks one has already done everything by speaking of a 'picture'; for longing is a content of consciousness, and a picture of it is something that is (very) like it, even though less clear than the original.

And it might well be said of someone who plays longing on the stage, that he experiences or has a picture of longing: not as an *explanation* of his action, but as a description of it.

Page 113

656. To be ashamed of a thought. Is one ashamed at the fact that one has spoken such-and-such a sentence in one's imagination?

Language is variously rooted; it has roots, not a single root. [*Marginal note:* ((Remembering a thought, an intention.)) A *seed*.]

Page 113

657. "It tastes exactly like sugar." How is it I can be so sure of this? Even if it turns out wrong.--And what astonishes me about it? That I bring the concept sugar into so *firm* a connexion with the taste sensation. That I seem to recognize the substance sugar directly in the taste.

Page Break 114

But instead of the expression "It tastes exactly..." I might more primitively exclaim "Sugar!" And can it be said that 'the substance sugar comes before my mind' at the word? How does it do that?

658. Can I say that this taste brought the name "sugar" along with it in a peremptory fashion? Or the picture of a lump of sugar? Neither seems right. The demand for the concept 'sugar' is indeed peremptory, just as much so, indeed, as the demand for the concept 'red' when we use it to describe what we see.

659. I remember that sugar tasted like this. The experience returns to consciousness. But, of course: how do I know that this was the earlier experience? Memory is no more use to me here. No, in those words--that the experience returns to consciousness.....--I am only transcribing my memory, not describing it.

But when I say "It tastes exactly like sugar", in an important sense no remembering takes place. So I do *not* have grounds for my judgment or my exclamation. If someone asks me "What do you mean by 'sugar'?"--I shall indeed try to shew him a lump of sugar. And if someone asks "How do you know that sugar tastes like that?" I shall indeed answer him "I've eaten sugar thousands of times"--but that is not a justification that I give myself.

660. "It tastes like sugar". One remembers exactly and with certainty what sugar tastes like. I do not say "I believe sugar tastes like this". What a remarkable phenomenon! It just is the phenomenon of memory.--But is it right to call it a remarkable phenomenon?

It is anything but remarkable. That certainty is not (by a hair's breadth) more remarkable than uncertainty would be. For what is remarkable? My saying with certainty "This tastes like sugar", or its then really being sugar? Or that other people find the same thing?

If the certain recognition of sugar is remarkable, then the failure to recognize it would be less so.

661. "What a queer and frightful sound. I shall never forget it". And why should one not be able to say that of remembering

("What a queer... experience...") when one has seen into the past for the first time?--

662. Remembering: a seeing into the past. *Dreaming* might be called that, when it presents the past to us. But not remembering; for, even if it shewed scenes with hallucinatory clarity, still it takes remembering to tell us that this is past.

663. But if memory shews us the past, how does it shew us that it is the past?

It does *not* shew us the past. Any more than our senses shew us the present.

664. Nor can it be said to communicate the past to us. For even supposing that memory were an audible voice that spoke to us--how could we understand it? If it tells us e.g. "Yesterday the weather was fine", how can I learn what "yesterday" means?

665. I give myself an exhibition of something only *in the same way* as I give one to other people.

666. I can display my good memory to someone else and also to myself. I can subject myself to an examination. (Vocabulary, dates).

667. But how do I give myself an exhibition of remembering? Well, I ask myself "How did I spend this morning?" and give myself an answer.--But what have I really exhibited to myself? Remembering? That is, what it's like to remember something?--Should I have exhibited remembering to *someone else* by doing that?

668. Forgetting the meaning of a word--and then remembering it again. What sort of processes go on here? What does one remember, what occurs to one, when one recalls what the French word "peut-être" means?

669. If I am asked "Do you know the ABC?" and I answer "Yes" I am not saying that I am now going through the ABC in my mind, or that I am in a special mental state that is somehow equivalent to the recitation of the ABC.†1

670. One can own a mirror; does one then own the reflection that can be seen in it?

671. Saying something is an activity, being inclined to say something a *state*. "But what does it consist in?"--Give yourself an account of how the expression is used.

672. "So long as the temperature of the rod does not fall below... it can be forged." So it makes sense to say: "I can forge it from five till six o'clock." Or: "I can play chess from five till six," i.e. I have time from five till six.--"So long as my pulse does not fall below... I can do the calculation." This calculation takes one and a half minutes; but how long does *being able to do* it take? And if you *can* do it for an hour, do you keep on starting afresh?

673. Attention is dynamic, not static--one would like to say. I begin by comparing attention to gazing but that is not what I call attention; and now I want to say that I find it is *impossible* that one should attend statically.

674. If in a particular case I say: attention consists in preparedness to follow each smallest movement that may appear--that is enough to shew you that attention is not a fixed gaze: no, this is a concept of a different kind.

675. States: 'Being able to climb a mountain' may be called a state of my body. I say: "I can climb it--I mean I am strong enough." Compare with this the following condition of being able. "Yes, I can go there"--I mean I have enough time.

676. What is the role of false propositions in a language-game? I believe there are various cases.

(1) Someone has to observe the signal lights at a street-crossing and to tell someone else what colours are shewing. He makes a slip of the tongue and says the wrong colour.

(2) Meteorological observations are put in train and the weather for the next day is predicted from them by certain rules. The prediction comes off or does not.

In the first case one can say he plays wrong; in the second one cannot--as at one time I thought.

Here one is tormented by a question running something like: Is the verification too part of the language-game?

677. I assert: "If *this* happens, *that* will happen. If I am right, you pay me a shilling, if I am wrong, I pay you one, if it remains undecided, neither pays". This might also be expressed like this: The case in which the antecedent does *not* come true does not interest us, we aren't talking about it. Or again: we do not find it natural to use the words "yes" and "no" in the same way as in the case (and there are such cases) in which we are interested in the material implication. By "No" we mean here "p and not q", by "Yes", only "p and q". There is no law of excluded middle running: Either you win the bet or you lose it--there is no third possibility.

678. Someone playing at dice throws first five, then four and says "If only I'd thrown a four instead of the five I'd have won!" The condition is not physical but only mathematical, for one might reply: "If you had thrown a four first,--who knows what you would have thrown after?"

679. If you say now "The use of the subjunctive is founded on belief in natural law--the rejoinder may be: "It is not *founded* on that belief; it and that belief are on the same level". (In a film I heard a father tell his daughter that he ought to have married a different woman: "*She* ought to have been your mother"! Why is this wrong?)

680. Fate stands in contrast to natural law. One seeks to find grounds for natural law and to use it, but not fate.

681. "If p occurs, then q occurs" might be called a conditional prediction. That is, I make *no* prediction for the case not-p. But for that reason what I say also remains unverified by "not-p and not-q".

Or even: there are conditional predictions and "p implies q" is *not* one. ((Relates to Vol. Q, p. 14.))†1

682. I will call the sentence "If p occurs then q occurs" "S".--"S or not S" is a tautology; but is it (also) the law of excluded middle?--Or again: If I want to say that the prediction "S"

may be right, wrong, or undecided, is that expressed by the sentence "not (S or not-S)"?

683. Is the negation of a proposition identical with the disjunction of the cases it does not exclude? In some cases it is. (E.g. in this one: "The permutation of the elements ABC that he wrote down was not ACB").

684. The important sense of Frege's assertion-sign is perhaps best grasped if we say: it signals clearly the *beginning of the sentence*.--This is *important*: for our philosophical difficulties about the nature of 'negation' and of 'thinking' hang together with the fact that a proposition "&unk; not-p" or "&unk; I believe p" does contain the proposition "p" but not "&unk; p". (For if I hear someone say: "it's raining" I don't know what he said if I don't know whether I heard the *beginning* of the sentence).†1

685. A contradiction prevents me from getting to act in the language-game.

686. But suppose the language-game consisted in my continuously being driven from one decision to the contrary one!

687. Contradiction is to be regarded, not as a catastrophe, but as a wall indicating that we can't go on here.

688. I should like to ask, not so much "What must we do to avoid a contradiction?" as "What ought we to do if we have arrived at a contradiction?"

689. Why is a contradiction more to be feared than a tautology?

690. Our motto might be: "Let us not be bewitched".

691†2. "The Cretan Liar". He might have written "This proposition is false" instead of "I am lying". The answer would be: "Very well, but which proposition do you mean?"--"Well, *this* proposition".--"I understand, but which is the proposition mentioned in *it*?"--"*This* one"--"Good, and which proposition

does *it* refer to?" and so on. Thus he would be unable to explain what he means until he passes to a complete proposition.--We may also say: The fundamental error lies in one's thinking that a phrase e.g. "This proposition" can as it were allude to its object (point to it from far off) without having to go proxy for it.

692. Let us raise the question: What practical purpose can be served by Russell's Theory of Types?--Russell makes us realize that we must sometimes put restrictions on the expression of generality in order to avoid having undesirable consequences drawn from it.

693. The reasoning that leads to an infinite regress is to be given up not 'because in this way we can never reach the goal', but because here there is no goal; so it makes no sense to say "we can never reach it".

We readily think that we must run through a few steps of the regress and then so to speak give it up in despair. Whereas its aimlessness (the lack of a goal in the calculus) can be derived from the starting position.

694. A variant of Cantor's diagonal proof:

Let $N = F(k, n)$ be the form of a law for the development of decimal fractions. N is the n^{th} decimal position of the k^{th} development. The law of the diagonal is then: $N = F(n, n) = \text{Def. } F'(n)$.

To prove: that $F'(n)$ cannot be one of the rules $F'(k, n)$. Assume it is the 100th. Then the rule for the construction

of $F'(1)$ runs $F(1, 1)$

of $F'(2)$ $F(2, 2)$ etc.

but the rule for the construction of the 100th position of $F'(n)$ becomes $F(100, 100)$ i.e. it shews only that the 100th place is supposed to be the same as itself, and so for $n = 100$ it is *not* a rule.

The rule of the game runs "Do the same as..."--and in the special case it becomes "Do the same as what you

do".

Page 119

695. The *understanding* of a mathematical question. How do we know if we understand a mathematical question? A question--it may be said--is a commission. And understanding a commission means: knowing what one has got

Page Break 120

to do. Naturally, a commission can be quite vague--e.g., if I say "Bring him something that'll do him good". But that may mean: think about him, about his state etc. in a friendly way and then bring him something corresponding to your sentiment towards him.

Page 120

696. A mathematical question is a challenge. And we might say: it makes sense, if it spurs us on to some mathematical activity.

Page 120

697. We might then also say that a question in mathematics makes sense if it stimulates the mathematical imagination.

Page 120

698. Translating from one language into another is a mathematical task, and the translation of a lyrical poem, for example, into a foreign language is quite analogous to a mathematical *problem*. For one may well frame the problem "How is this joke (e.g.) to be translated (i.e. replaced) by a joke in the other language?" and this problem can be solved; but there was no systematic method of solving it.

Page 120

699. Imagine human beings who calculate with 'extremely complicated' numerals. These present themselves as figures which arise if our numerals are written on top of one another. They write e.g. π up to the fifth place like this:



. If you watch them you find it difficult to guess *what* they are doing. And they themselves perhaps cannot explain it. For this numeral, written in a somewhat different notation, may alter its appearance to the point of unrecognizability by us. And what the people were doing would seem to us purely intuitive.

Page 120

700. Why do we count? Has it proved practical? Do we have the concepts we have, e.g. our psychological concepts, because it has proved advantageous?--And yet we do have *certain* concepts on that account, we have introduced them on that account.

Page 120

701. At any rate the difference between what are called propositions of mathematics and empirical propositions comes to light if one reflects whether it makes sense to say: "I wish twice two were five!"

Page Break 121

Page 121

702. If one considers that $2 + 2 = 4$ is a proof of the proposition "there are even numbers", one sees how loosely the word "proof" is used here. The proposition "there are even numbers" is supposed to proceed from the equation $2 + 2 = 4$!--And what is the proof of the existence of prime numbers?--The method of reduction to prime factors. But in this method *nothing is said*, not even about "prime numbers".

Page 121

703. "To understand sums in the elementary school the children would have to be important philosophers; failing that, they need practice".†1

Page 121

704. Russell and Frege take concepts as, as it were, properties of things. But it is very unnatural to take the words man, tree, treatise, circle, as properties of a substrate.†2

Page 121

705. Dirichlet's conception of a function is only possible where it does not seek to express an infinite rule by a list, for there is no such thing as an infinite list.

Page 121

706. Numbers are not fundamental to mathematics.

Page 121

707. The concept of the 'order' of the rational numbers, e.g., and of the impossibility of so ordering the irrational

numbers. Compare this with what is called an 'ordering' of digits. Likewise the difference between the 'co-ordination' of one digit (or nut) with another and the 'co-ordination' of all whole numbers with the even numbers; etc. Everywhere distortion of concepts.

Page 121

708. There is obviously a method of making a straight-edge. This method involves an ideal, I mean an approximation-procedure of unlimited *possibility*, for this very procedure *is* the ideal.

Or rather: only if there is an approximation-procedure of unlimited possibility can (not must) the geometry of this procedure be Euclidean.†3

Page 121

709. To regard a calculation as an ornament is also formalism, but of a good sort.

Page 121

710. A calculation can be regarded as an ornament. A figure in a plane may fit another one or not, may be taken with other ones

Page Break 122

in various ways. If further the figure is coloured, there is a further fit according to colour. (Colour is only another dimension).

Page 122

711. There is a way of looking at electrical machines and installations (dynamoes, radio stations, etc., etc.) which sees these objects as arrangements of copper, iron, rubber etc. in space, without any preliminary understanding. And this way of looking at them might lead to some interesting results. It is quite analogous to looking at a mathematical proposition as an ornament.--It is of course an absolutely strict and correct conception; and the characteristic and difficult thing about it is that it looks at the object without any preconceived idea (as it were from a Martian point of view), or perhaps more correctly: it upsets the normal preconceived idea, explanation (runs athwart it).

Page 122

712. (The style of my sentences is extraordinarily strongly influenced by Frege. And if I wanted to, I could establish this influence where at first sight no one would see it).

Page 122

713. "Put it *here*"--indicating the place with one's finger--that is giving an *absolute* spatial position. And if someone says that space is absolute he might produce this as an argument for it: "There is a *place: here*". [*Marginal note: ((Perhaps belongs with the first language-games.))*]

Page 122

714. A mental illness could be imagined in which one can use and understand a name only in the presence of the bearer.

Page 122

715. There might be a use of signs made, such that they become useless (they are destroyed) as soon as the bearer has ceased to exist.

In this language-game the name has the object on a string, so to speak; and if the object ceases to exist, the name, which has done its work in conjunction with the object, can be thrown away. (The word "handle" for a proper name).

Page 122

716. What about these two sentences: "This sheet is red" and "this sheet is the colour called 'red' in English"? Do they both say *the same*?

Page Break 123

Page 123

Doesn't this depend on what the criterion is for a colour's being called 'red' in English?

Page 123

717. "You can't hear God speak to someone else, you can hear him only if you are being addressed".--That is a grammatical remark.

FOOTNOTES

Page 3

†1 Schiller, *Wallenstein, Die Piccolomini*, Act I, Scene 2. The words are in fact said by Illo, and not by Max.

Page 13

- †1 See *Philosophical [[sic]] Bemerkungen* § 31. Eds.
Page 13
- †2 See *Philosophical Investigations* § 581. Eds.
Page 13
- †3 See *Philosophische Bemerkungen* § 25. Eds.
Page 13
- †4 *Theaetetus* 189a. Eds.
Page 16
- †1 In the original this sentence is in square brackets. Here as elsewhere we have shown this as double brackets. Eds.
Page 17
- †1 "Experience" is crossed out in the typescript. Eds.
Page 17
- †2 See *Philosophical Investigations* § 2. Eds.
Page 18
- †1 See *Philosophical Investigations* § 2. Eds.
Page 24
- †1 See *Philosophical Investigations* § 556. Eds.
Page 30
- †1 "Heaven be praised! A little slipped--out of the Croat clutches." Schiller, *Wallenstein, Die Piccolomini*, Act 1, Scene 2.
Page 45
- †1 No drawing appears in the MS. at this place; the reader may imagine something appropriate. Of various possibilities, we have adopted a drawing by Dr. R. B. O. Richards. Eds.
Page 47
- †1 See *Philosophische Bemerkungen* § 66. Eds.
Page 47
- †2 See *Philosophische Bemerkungen* § 95. Eds.
Page 48
- †1 See *Philosophische Bemerkungen* § 66. Ed&. Eds.
Page 49
- †1 Supplied from source-typescript. Eds.
Page 50
- †1 See *Philosophical Investigations* § 229. Eds.
Page 51
- †1 See *Philosophical Remarks* § 130. Eds.
Page 51
- †2 See *Philosophische Bemerkungen* §§ 235, 236. Eds.
Page 54
- †1 See *Remarks on the Foundations of Mathematics* V--§ 46; new edition VII--§ 67. Eds.
Page 64
- †1 This remark was not among those preserved in the box of cuttings; we have supplied it from the typescript from another copy of which the succeeding remark was cut. Eds.
Page 66
- †1 The cuttings include the following, omitted from the 1st edition: (Relates to what Frege, and occasionally Ramsey, said about recognition as a condition of symbolizing. What is the criterion for my having recognized colour right? Something like the experience of joy in recognizing?) Eds.
Page 78
- †* Freud speaks of his 'dynamic' theory of dreams.
Page 79
- †1 See *Philosophical Investigations* § 154. Eds.
Page 80
- †1 *Philosophische Bemerkungen* § 2. Eds.
Page 80
- †2 *Charmides*, 174d-175a. Eds.
Page 81
- †1 because the search says more than the discovery... Eds.

Page 81

†2 After this remark there occur in the typescript the words: "Such irritations are wont to stimulate the powers of thought." How does thought remedy an irritation?--The passage is missing from the first edition of *Zettel*. Eds.

Page 81

†3 See *Philosophical Investigations* § 144. Eds.

Page 96

†1 See *Philosophical Investigations* § 300. Eds.

Page 98

†1 In the typescript of the *Zettel* there is here the further remark: How could you explain what it means "to simulate pain", "to put on a show of pain"? Eds.

Page 98

†2 See *Philosophical Investigations* p. 174. Eds.

Page 100

†1 See *Philosophical Investigations* § 613. Eds.

Page 100

†2 *Schatzkästlein*, Zwei Erzählungen. Eds.

Page 107

†1 *Philosophische Bemerkungen* § 224. Eds.

Page 115

†1 After this remark there occur in the typescript the words: How does one teach anyone to read to himself? How does one know if he can do so? How does he himself know that he is doing what is required of him?--This is paragraph 375 in PI. Eds.

Page 117

†1 The reference is to MS. 136. Eds.

Page 118

†1 See *Philosophical Investigations* § 22. Eds.

Page 118

†2 See *Philosophical Investigations* § 16. Eds.

Page 121

†1 Here in the typescript there occurs: When we read an explanation say of logical consequence, we rely on what he writes; on the signs ((on (for me) the calculus)). Eds.

Page 121

†2 See *Philosophical Remarks* § 96. Eds.

Page 121

†3 See *Philosophische Bemerkungen* § 178. Eds.

PHILOSOPHICAL INVESTIGATIONS

Page i



Page Break ii

Page ii

Ludwig Wittgenstein from Blackwell Publishers

The Wittgenstein Reader
Edited by Anthony Kenny

Zettel
Second Edition
Edited by G.E.M. Anscombe and G.H. von Wright

Remarks on Colour

Edited by G.E.M. Anscombe

Remarks on the Foundations of Mathematics

Third edition

Edited by G.H. von Wright, Rush Rhees and G.E.M. Anscombe

Philosophical Remarks

Edited by Rush Rhees

Philosophical Grammar

Edited by Rush Rhees

On Certainty

Edited by G.E.M. Anscombe and G.H. von Wright

Lectures and Conversations

Edited by Cyril Barrett

Culture and Value

Edited by G.H. von Wright

The Blue and Brown Books

Preliminary Studies for the *Philosophical Investigations*

Remarks on the Philosophy of Psychology, Vol. I

Edited by G.E.M. Anscombe and G.H. von Wright

Remarks on the Philosophy of Psychology, Vol. II

Edited by G.E.M. Anscombe and Heikki Nyman

Last Writings on the Philosophy of Psychology, Vol. I

Edited by G.H. von Wright and Heikki Nyman

Last Writings on the Philosophy of Psychology, Vol. II

Edited by G.H. von Wright and Heikki Nyman

Page Break iii

Titlepage

Page iii

PHILOSOPHICAL INVESTIGATIONS

Second Edition

By

LUDWIG WITTGENSTEIN

Translated by

G. E. M. ANSCOMBE

Page Break iv

Copyright page

Page iv

Copyright © Blackwell Publishers Ltd, 1953, 1958, 1997

First published 1953

Second edition 1958

Reprinted 1963, 1967, 1997, 1998, 1999

Blackwell Publishers Ltd
108 Cowley Road
Oxford OX4 1JF
UK

Blackwell Publishers Inc.
350 Main Street
Malden, Massachusetts 02148
USA

All rights reserved. Except for the quotation of short passages for the purposes of criticism and review, no part of this publication may be reproduced, stored in a retrieval system, or transmitted, in any form or by any means, electronic, mechanical, photocopying, recording or otherwise, without the prior permission of the publisher.

Except in the United States of America, this book is sold subject to the condition that it shall not, by way of trade or otherwise, be lent, re-sold, hired out, or otherwise circulated without the publisher's prior consent in any form of binding or cover other than that in which it is published and without a similar condition including this condition being imposed on the subsequent purchaser.

British Library Cataloguing in Publication Data

A CIP catalogue record for this book is available from the British Library.

Library of Congress Cataloging-in-Publication Data
Wittgenstein, Ludwig, 1889-1951.

[Philosophische Untersuchungen. English & German]

Philosophical investigations / by Ludwig Wittgenstein: translated by G.E.M. Anscombe.--2nd ed. rept. p. cm.
Includes index.

Added title page title: Philosophische Untersuchungen.
ISBN 0-631-20569-1 (pbk: alk. paper)

1. Philosophy. 2. Language and languages--Philosophy.

2. Semantics (Philosophy) I. Anscombe, G. E. M. (Gertrude Elizabeth Margaret) II. Title. III. Title: Philosophische Untersuchungen

B3376.W563P53 1997

192-dc2196-37331

CIP

Printed in Great Britain by T. J. International, Padstow, Cornwall

Page Break v

TRANSLATOR'S NOTE

Page v

MY acknowledgements are due to the following, who either checked the translation or allowed me to consult them about German and Austrian usage or read the translation through and helped me to improve the English: Mr. R. Rhees, Professor G. H. von Wright, Mr. P. Geach, Mr. G. Kreisel, Miss L. Labowsky, Mr. D. Paul, Miss I. Murdoch.

NOTE TO SECOND EDITION

Page v

THE text has been revised for the new edition. Alterations on the German side have been few, and have been confined to mistakes in spelling or punctuation. A large number of small changes have been made in the English text. The following passages have been significantly altered:

Page v

In Part I: §§ 108, 109, 116, 189, 193, 251, 284, 352, 360, 393, 418, 426, 442, 456, 493, 520, 556, 582, 591, 644, 690, 692.

Page v

In Part II: pp. 193e, 211e, 216e, 217e, 220e, 232e.

NOTE TO THE RE-ISSUED SECOND EDITION

Page v

THE graphical representations have been reassessed by Michael A. R. Biggs of the University of Hertfordshire, UK. Reference has been made to both the manuscript sources for this volume and to the broader context of Wittgenstein's writings and graphical practice as a whole. Such a synoptic view was not available when this volume was first published and the editors have taken the opportunity to incorporate recommendations on the grounds of improved legibility, felicity or perspicuity. Revisions have been made to the graphics on the following pages: 23, 138, 193, 203 and 210. The parallel German and English text is identical to the 1967 issue, with the exception of the substitution of the word 'sigma' by the sign 'σ' on page 67.

Page Break vi

EDITORS' NOTE

Page vi

WHAT appears as Part I of this volume was complete by 1945. Part II was written between 1947 and 1949. If Wittgenstein had published his work himself, he would have suppressed a good deal of what is in the last thirty pages or so of Part I and worked what is in Part II, with further material, into its place.

Page vi

We have had to decide between variant readings for words and phrases throughout the manuscript. The choice never affected the sense.

Page vi

The passages printed beneath a line at the foot of some pages are written on slips which Wittgenstein had cut from other writings and inserted at these pages, without any further indication of where they were to come in.

Page vi

Words standing between double brackets are Wittgenstein's references to remarks either in this work or in other writings of his which we hope will appear later.

Page vi

We are responsible for placing the final fragment of Part II in its present position.

G. E. M. ANSCOMBE
R. RHEES

Page Break vii

Page vii

"Überhaupt hat der Fortschritt das an sich, daß er viel größer ausschaut, als er wirklich ist".

NESTROY

Page Break viii

PREFACE

Page viii

THE thoughts which I publish in what follows are the precipitate of philosophical investigations which have occupied me for the last sixteen years. They concern many subjects: the concepts of meaning, of understanding, of a proposition, of logic, the foundations of mathematics, states of consciousness, and other things. I have written down all these thoughts as *remarks*, short paragraphs, of which there is sometimes a fairly long chain about the same subject, while I sometimes make a sudden change, jumping from one topic to another.--It was my intention at first to bring all this together in a book whose form I pictured differently at different times. But the essential thing was that the thoughts should proceed from one subject to another in a natural order and without breaks.

Page viii

After several unsuccessful attempts to weld my results together into such a whole, I realized that I should never succeed. The best that I could write would never be more than philosophical remarks; my thoughts were soon crippled if I tried to force them on in any single direction against their natural inclination.--And this was, of course, connected with the very nature of the investigation. For this compels us to travel over a wide field of thought criss-cross in every direction.--The philosophical remarks in this book are, as it were, a number of sketches of landscapes which were made in the course of these long and involved journeyings.

Page viii

The same or almost the same points were always being approached afresh from different directions, and new sketches made. Very many of these were badly drawn or uncharacteristic, marked by all the defects of a weak draughtsman. And when they were rejected a number of tolerable ones were left, which now had to be arranged and

sometimes cut down, so that if you looked at them you could get a picture of the landscape. Thus this book is really only an album.

Page viii

Up to a short time ago I had really given up the idea of publishing my work in my lifetime. It used, indeed, to be revived from time to time: mainly because I was obliged to learn that my results (which I had communicated in lectures, typescripts and discussions), variously

Page Break ix

misunderstood, more or less mangled or watered down, were in circulation. This stung my vanity and I had difficulty in quieting it.

Page ix

Four years ago I had occasion to re-read my first book (the *Tractatus Logico-Philosophicus*) and to explain its ideas to someone. It suddenly seemed to me that I should publish those old thoughts and the new ones together: that the latter could be seen in the right light only by contrast with and against the background of my old way of thinking.†1

Page ix

For since beginning to occupy myself with philosophy again, sixteen years ago, I have been forced to recognize grave mistakes in what I wrote in that first book. I was helped to realize these mistakes--to a degree which I myself am hardly able to estimate--by the criticism which my ideas encountered from Frank Ramsey, with whom I discussed them in innumerable conversations during the last two years of his life. Even more than to this--always certain and forcible--criticism I am indebted to that which a teacher of this university, Mr. P. Sraffa, for many years unceasingly practised on my thoughts. I am indebted to *this* stimulus for the most consequential ideas of this book.

Page ix

For more than one reason what I publish here will have points of contact with what other people are writing to-day.--If my remarks do not bear a stamp which marks them as mine,--I do not wish to lay any further claim to them as my property.

Page ix

I make them public with doubtful feelings. It is not impossible that it should fall to the lot of this work, in its poverty and in the darkness of this time, to bring light into one brain or another--but, of course, it is not likely.

Page ix

I should not like my writing to spare other people the trouble of thinking. But, if possible, to stimulate someone to thoughts of his own.

Page ix

I should have liked to produce a good book. This has not come about, but the time is past in which I could improve it.

CAMBRIDGE,
January 1945.

Page Break x

Page Break 1

PART I

Page 1

Page Break 2

Page 2

1. "Cum ipsi (maiores homines) appellabant rem aliquam, et cum secundum eam vocem corpus ad aliquid movebant, videbam, et tenebam hoc ab eis vocari rem illam, quod sonabant, cum eam vellent ostendere. Hoc autem eos velle ex motu corporis aperiebatur: tamquam verbis naturalibus omnium gentium, quae fiunt vultu et nutu oculorum, ceterorumque membrorum actu, et sonitu vocis indicante affectionem animi in petendis, habendis, rejiciendis, fugiendisve rebus. Ita verba in variis sententiis locis suis posita, et crebro audita, quarum rerum signa essent, paulatim colligebam, measque jam voluntates, edomito in eis signis ore, per haec enuntiabam." (Augustine, *Confessions*, I. 8.)†1

Page 2

These words, it seems to me, give us a particular picture of the essence of human language. It is this: the individual words in language name objects--sentences are combinations of such names.--In this picture of language we find the roots of the following idea: Every word has a meaning. This meaning is correlated with the word. It is the

object for which the word stands.

Page 2

Augustine does not speak of there being any difference between kinds of word. If you describe the learning of language in this way you are, I believe, thinking primarily of nouns like "table", "chair", "bread", and of people's names, and only secondarily of the names of certain actions and properties; and of the remaining kinds of word as something that will take care of itself.

Page 2

Now think of the following use of language: I send someone shopping. I give him a slip marked "five red apples". He takes the slip to

Page Break 3

the shopkeeper, who opens the drawer marked "apples"; then he looks up the word "red" in a table and finds a colour sample opposite it; then he says the series of cardinal numbers--I assume that he knows them by heart--up to the word "five" and for each number he takes an apple of the same colour as the sample out of the drawer.--It is in this and similar ways that one operates with words.--"But how does he know where and how he is to look up the word 'red' and what he is to do with the word 'five'?"--Well, I assume that he *acts* as I have described. Explanations come to an end somewhere.--But what is the meaning of the word "five"?--No such thing was in question here, only how the word "five" is used.

Page 3

2. That philosophical concept of meaning has its place in a primitive idea of the way language functions. But one can also say that it is the idea of a language more primitive than ours.

Page 3

Let us imagine a language for which the description given by Augustine is right. The language is meant to serve for communication between a builder A and an assistant B. A is building with building-stones: there are blocks, pillars, slabs and beams. B has to pass the stones, and that in the order in which A needs them. For this purpose they use a language consisting of the words "block", "pillar", "slab", "beam". A calls them out;--B brings the stone which he has learnt to bring at such-and-such a call.--Conceive this as a complete primitive language.

Page 3

3. Augustine, we might say, does describe a system of communication; only not everything that we call language is this system. And one has to say this in many cases where the question arises "Is this an appropriate description or not?" The answer is: "Yes, it is appropriate, but only for this narrowly circumscribed region, not for the whole of what you were claiming to describe."

Page 3

It is as if someone were to say: "A game consists in moving objects about on a surface according to certain rules..."--and we replied: You seem to be thinking of board games, but there are others. You can make your definition correct by expressly restricting it to those games.

Page 3

4. Imagine a script in which the letters were used to stand for sounds, and also as signs of emphasis and punctuation. (A script can be conceived as a language for describing sound-patterns.) Now imagine someone interpreting that script as if there were simply a

Page Break 4

correspondence of letters to sounds and as if the letters had not also completely different functions. Augustine's conception of language is like such an over-simple conception of the script.

Page 4

5. If we look at the example in §1, we may perhaps get an inkling how much this general notion of the meaning of a word surrounds the working of language with a haze which makes clear vision impossible. It disperses the fog to study the phenomena of language in primitive kinds of application in which one can command a clear view of the aim and functioning of the words.

Page 4

A child uses such primitive forms of language when it learns to talk. Here the teaching of language is not explanation, but training.

Page 4

6. We could imagine that the language of §2 was the *whole* language of A and B; even the whole language of a tribe. The children are brought up to perform *these* actions, to use *these* words as they do so, and to react in *this* way to the words of others.

An important part of the training will consist in the teacher's pointing to the objects, directing the child's attention to them, and at the same time uttering a word; for instance, the word "slab" as he points to that shape. (I do not want to call this "ostensive definition", because the child cannot as yet *ask* what the name is. I will call it "ostensive teaching of words".--I say that it will form an important part of the training, because it is so with human beings; not because it could not be imagined otherwise.) This ostensive teaching of words can be said to establish an association between the word and the thing. But what does this mean? Well, it can mean various things; but one very likely thinks first of all that a picture of the object comes before the child's mind when it hears the word. But now, if this does happen--is it the purpose of the word?--Yes, it *can* be the purpose.--I can imagine such a use of words (of series of sounds). (Uttering a word is like striking a note on the keyboard of the imagination.) But in the language of §2 it is *not* the purpose of the words to evoke images. (It may, of course, be discovered that that helps to attain the actual purpose.)

But if the ostensive teaching has this effect,--am I to say that it effects an understanding of the word? Don't you understand the call "Slab!" if you act upon it in such-and-such a way?--Doubtless the ostensive teaching helped to bring this about; but only together with a particular

training. With different training the same ostensive teaching of these words would have effected a quite different understanding.

"I set the brake up by connecting up rod and lever."--Yes, given the whole of the rest of the mechanism. Only in conjunction with that is it a brake-lever, and separated from its support it is not even a lever; it may be anything, or nothing.

7. In the practice of the use of language (2) one party calls out the words, the other acts on them. In instruction in the language the following process will occur: the learner *names* the objects; that is, he utters the word when the teacher points to the stone.--And there will be this still simpler exercise: the pupil repeats the words after the teacher--both of these being processes resembling language.

We can also think of the whole process of using words in (2) as one of those games by means of which children learn their native language. I will call these games "language-games" and will sometimes speak of a primitive language as a language-game.

And the processes of naming the stones and of repeating words after someone might also be called language-games. Think of much of the use of words in games like ring-a-ring-a-roses.

I shall also call the whole, consisting of language and the actions into which it is woven, the "language-game".

8. Let us now look at an expansion of language (2). Besides the four words "block", "pillar", etc., let it contain a series of words used as the shopkeeper in (1) used the numerals (it can be the series of letters of the alphabet); further, let there be two words, which may as well be "there" and "this" (because this roughly indicates their purpose), that are used in connexion with a pointing gesture; and finally a number of colour samples. A gives an order like: "d--slab--there". At the same time he shews the assistant a colour sample, and when he says "there" he points to a place on the building site. From the stock of slabs B takes one for each letter of the alphabet up to "d", of the same colour as the sample, and brings them to the place indicated by A.--On other occasions A gives the order "this--there". At "this" he points to a building stone. And so on.

9. When a child learns this language, it has to learn the series of 'numerals' a, b, c,... by heart. And it has to learn their use.--Will this training include ostensive teaching of the words?--Well, people

will, for example, point to slabs and count: "a, b, c slabs".--Something more like the ostensive teaching of the words "block", "pillar", etc. would be the ostensive teaching of numerals that serve not to count but to refer to groups of objects that can be taken in at a glance. Children do learn the use of the first five or six cardinal numerals in this way.

Are "there" and "this" also taught ostensively?--Imagine how one might perhaps teach their use. One will point to places and things--but in this case the pointing occurs in the use of the words too and not merely in learning the use.--

Page 6

10. Now what do the words of this language *signify*?--What is supposed to shew what they signify, if not the kind of use they have? And we have already described that. So we are asking for the expression "This word signifies *this*" to be made a part of the description. In other words the description ought to take the form: "The word.... signifies....".

Page 6

Of course, one can reduce the description of the use of the word "slab" to the statement that this word signifies this object. This will be done when, for example, it is merely a matter of removing the mistaken idea that the word "slab" refers to the shape of building-stone that we in fact call a "block"--but the kind of '*referring*' this is, that is to say the use of these words for the rest, is already known.

Page 6

Equally one can say that the signs "a", "b", etc. signify numbers; when for example this removes the mistaken idea that "a", "b", "c", play the part actually played in language by "block", "slab", "pillar". And one can also say that "c" means this number and not that one; when for example this serves to explain that the letters are to be used in the order a, b, c, d, etc. and not in the order a, b, d, c.

Page 6

But assimilating the descriptions of the uses of words in this way cannot make the uses themselves any more like one another. For, as we see, they are absolutely unlike.

Page 6

11. Think of the tools in a tool-box: there is a hammer, pliers, a saw, a screw-driver, a rule, a glue-pot, glue, nails and screws.--The functions of words are as diverse as the functions of these objects. (And in both cases there are similarities.)

Page 6

Of course, what confuses us is the uniform appearance of words when we hear them spoken or meet them in script and print. For their *application* is not presented to us so clearly. Especially when we are doing philosophy!

Page Break 7

Page 7

12. It is like looking into the cabin of a locomotive. We see handles all looking more or less alike. (Naturally, since they are all supposed to be handled.) But one is the handle of a crank which can be moved continuously (it regulates the opening of a valve); another is the handle of a switch, which has only two effective positions, it is either off or on; a third is the handle of a brake-lever, the harder one pulls on it, the harder it brakes; a fourth, the handle of a pump: it has an effect only so long as it is moved to and fro.

Page 7

13. When we say: "Every word in language signifies something" we have so far said *nothing whatever*; unless we have explained exactly *what* distinction we wish to make. (It might be, of course, that we wanted to distinguish the words of language (8) from words 'without meaning' such as occur in Lewis Carroll's poems, or words like "Lilliburlero" in songs.)

Page 7

14. Imagine someone's saying: "All tools serve to modify something. Thus the hammer modifies the position of the nail, the saw the shape of the board, and so on."--And what is modified by the rule, the glue-pot, the nails?--"Our knowledge of a thing's length, the temperature of the glue, and the solidity of the box."--Would anything be gained by this assimilation of expressions?--

Page 7

15. The word "to signify" is perhaps used in the most straightforward way when the object signified is marked with the sign. Suppose that the tools A uses in building bear certain marks. When A shews his assistant such a mark, he brings the tool that has that mark on it.

Page 7

It is in this and more or less similar ways that a name means and is given to a thing.--It will often prove useful in philosophy to say to ourselves: naming something is like attaching a label to a thing.

Page 7

16. What about the colour samples that A shews to B: are they part of the *language*? Well, it is as you please. They do not belong among the words; yet when I say to someone: "Pronounce the word 'the'", you will count the second "the" as part of the sentence. Yet it has a role just like that of a colour-sample in language-game (8); that is, it

is a sample of what the other is meant to say.

Page 7

It is most natural, and causes least confusion, to reckon the samples among the instruments of the language.

Page 7

((Remark on the reflexive pronoun "*this* sentence".))

Page Break 8

Page 8

17. It will be possible to say: In language (8) we have different *kinds of word*. For the functions of the word "slab" and the word "block" are more alike than those of "slab" and "d". But how we group words into kinds will depend on the aim of the classification,--and on our own inclination.

Page 8

Think of the different points of view from which one can classify tools or chess-men.

Page 8

18. Do not be troubled by the fact that languages (2) and (8) consist only of orders. If you want to say that this shews them to be incomplete, ask yourself whether our language is complete;--whether it was so before the symbolism of chemistry and the notation of the infinitesimal calculus were incorporated in it; for these are, so to speak, suburbs of our language. (And how many houses or streets does it take before a town begins to be a town?) Our language can be seen as an ancient city: a maze of little streets and squares, of old and new houses, and of houses with additions from various periods; and this surrounded by a multitude of new boroughs with straight regular streets and uniform houses.

Page 8

19. It is easy to imagine a language consisting only of orders and reports in battle.--Or a language consisting only of questions and expressions for answering yes and no. And innumerable others.--And to imagine a language means to imagine a form of life.

Page 8

But what about this: is the call "Slab!" in example (2) a sentence or a word?--If a word, surely it has not the same meaning as the like-sounding word of our ordinary language, for in §2 it is a call. But if a sentence, it is surely not the elliptical sentence: "Slab!" of our language.--As far as the first question goes you can call "Slab!" a word and also a sentence; perhaps it could be appropriately called a 'degenerate sentence' (as one speaks of a degenerate hyperbola); in fact it *is* our 'elliptical' sentence.--But that is surely only a shortened form of the sentence "Bring me a slab", and there is no such sentence in example (2).--But why should I not on the contrary have called the sentence "Bring me a slab" a *lengthening* of the sentence "Slab!"?--Because if you shout "Slab!" you really mean: "Bring me a slab".--But how do you do this: how do you *mean that* while you say "Slab!"? Do you say the unshortened sentence to yourself? And why should I translate the call "Slab!" into a different expression in order to say

Page Break 9

what someone means by it? And if they mean the same thing--why should I not say: "When he says 'Slab!' he means 'Slab!'"? Again, if you can mean "Bring me the slab", why should you not be able to mean "Slab!"?--But when I call "Slab!", then what I want is, *that he should bring me a slab!*--Certainly, but does 'wanting this' consist in thinking in some form or other a different sentence from the one you utter?--

Page 9

20. But now it looks as if when someone says "Bring me a slab" he could mean this expression as *one* long word corresponding to the single word "Slab!"--Then can one mean it sometimes as one word and sometimes as four? And how does one usually mean it?--I think we shall be inclined to say: we mean the sentence as *four* words when we use it in contrast with other sentences such as "*Hand* me a slab", "Bring *him* a slab", "Bring *two* slabs", etc.; that is, in contrast with sentences containing the separate words of our command in other combinations.--But what does using one sentence in contrast with others consist in? Do the others, perhaps, hover before one's mind? *All* of them? And *while* one is saying the one sentence, or before, or afterwards?--No. Even if such an explanation rather tempts us, we need only think for a moment of what actually happens in order to see that we are going astray here. We say that we use the command in contrast with other sentences because *our language* contains the possibility of those other sentences. Someone who did not understand our language, a foreigner, who had fairly often heard someone giving the order: "Bring me a slab!", might believe that this whole series of sounds was one word corresponding perhaps to the word for "building-stone" in his language. If he himself had then given this order perhaps he would have pronounced it differently, and we should say: he pronounces it so oddly because he takes it for a *single* word.--But then, is there not also something different going on in him when he pronounces it,--something corresponding to the fact that he conceives the sentence as a *single* word?--Either the same thing may

go on in him, or something different. For what goes on in you when you give such an order? Are you conscious of its consisting of four words *while* you are uttering it? Of course you have a *mastery* of this language--which contains those other sentences as well--but is this having a mastery something that *happens* while you are uttering the sentence?--And I have admitted that the foreigner will probably pronounce a sentence differently if he conceives it differently; but what we call his wrong conception *need* not lie in anything that accompanies the utterance of the command.

Page Break 10

Page 10

The sentence is 'elliptical', not because it leaves out something that we think when we utter it, but because it is shortened--in comparison with a particular paradigm of our grammar.--Of course one might object here: "You grant that the shortened and the unshortened sentence have the same sense.--What is this sense, then? Isn't there a verbal expression for this sense?"--But doesn't the fact that sentences have the same sense consist in their having the same *use*?--(In Russian one says "stone red" instead of "the stone is red"; do they feel the copula to be missing in the sense, or attach it in *thought*?)

Page 10

21. Imagine a language-game in which A asks and B reports the number of slabs or blocks in a pile, or the colours and shapes of the building-stones that are stacked in such-and-such a place.--Such a report might run: "Five slabs". Now what is the difference between the report or statement "Five slabs" and the order "Five slabs!"?--Well, it is the part which uttering these words plays in the language-game. No doubt the tone of voice and the look with which they are uttered, and much else besides, will also be different. But we could also imagine the tone's being the same--for an order and a report can be spoken in a *variety* of tones of voice and with various expressions of face--the difference being only in the application. (Of course, we might use the words "statement" and "command" to stand for grammatical forms of sentence and intonations; we do in fact call "Isn't the weather glorious to-day?" a question, although it is used as a statement.) We could imagine a language in which *all* statements had the form and tone of rhetorical questions; or every command the form of the question "Would you like to...?". Perhaps it will then be said: "What he says has the form of a question but is really a command",--that is, has the function of a command in the technique of using the language. (Similarly one says "You will do this" not as a prophecy but as a command. What makes it the one or the other?)

Page 10

22. Frege's idea that every assertion contains an assumption, which is the thing that is asserted, really rests on the possibility found in our language of writing every statement in the form: "It is asserted that such-and-such is the case."--But "that such-and-such is the case" is *not* a sentence in our language--so far it is not a *move* in the language-game. And if I write, not "It is asserted that....", but "It is asserted: such-and-such is the case", the words "It is asserted" simply become superfluous.

Page 10

We might very well also write every statement in the form of a

Page Break 11

question followed by a "Yes"; for instance: "Is it raining? Yes!" Would this shew that every statement contained a question?

Page 11

Of course we have the right to use an assertion sign in contrast with a question-mark, for example, or if we want to distinguish an assertion from a fiction or a supposition. It is only a mistake if one thinks that the assertion consists of two actions, entertaining and asserting (assigning the truth-value, or something of the kind), and that in performing these actions we follow the propositional sign roughly as we sing from the musical score. Reading the written sentence loud or soft is indeed comparable with singing from a musical score, but '*meaning*' (thinking) the sentence that is read is not.

Page 11

Frege's assertion sign marks the *beginning of the sentence*. Thus its function is like that of the full-stop. It distinguishes the whole period from a clause *within* the period. If I hear someone say "it's raining" but do not know whether I have heard the beginning and end of the period, so far this sentence does not serve to tell me anything.

Page 11

Imagine a picture representing a boxer in a particular stance. Now, this picture can be used to tell someone how he should stand, should hold himself; or how he should not hold himself; or how a particular man did stand in such-and-such a place; and so on. One might (using the language of chemistry) call this picture a proposition-radical.

This will be how Frege thought of the "assumption".

Page 11

23. But how many kinds of sentence are there? Say assertion, question, and command?--There are *countless* kinds: countless different kinds of use of what we call "symbols", "words", "sentences". And this multiplicity is not something fixed, given once for all; but new types of language, new language-games, as we may say, come into existence, and others become obsolete and get forgotten. (We can get a *rough picture* of this from the changes in mathematics.)

Page 11

Here the term "language-*game*" is meant to bring into prominence the fact that the *speaking* of language is part of an activity, or of a form of life.

Page 11

Review the multiplicity of language-games in the following examples, and in others:

Giving orders, and obeying them--

Describing the appearance of an object, or giving its measurements--

Constructing an object from a description (a drawing)--

Reporting an event--

Speculating about an event--

Page 11

Page Break 12

Page 12

Forming and testing a hypothesis--

Presenting the results of an experiment in tables and diagrams--

Making up a story; and reading it--

Play-acting--

Singing catches--

Guessing riddles--

Making a joke; telling it--

Solving a problem in practical arithmetic--

Translating from one language into another--

Asking, thanking, cursing, greeting, praying.

--It is interesting to compare the multiplicity of the tools in language and of the ways they are used, the multiplicity of kinds of word and sentence, with what logicians have said about the structure of language. (Including the author of the *Tractatus Logico-Philosophicus*.)

Page 12

24. If you do not keep the multiplicity of language-games in view you will perhaps be inclined to ask questions like: "What is a question?"--Is it the statement that I do not know such-and-such, or the statement that I wish the other person would tell me....? Or is it the description of my mental state of uncertainty?--And is the cry "Help!" such a description?

Page 12

Think how many different kinds of thing are called "description": description of a body's position by means of its co-ordinates; description of a facial expression; description of a sensation of touch; of a mood.

Page 12

Of course it is possible to substitute the form of statement or description for the usual form of question: "I want to know whether...." or "I am in doubt whether...."--but this does not bring the different language-games any closer together.

Page 12

The significance of such possibilities of transformation, for example of turning all statements into sentences beginning "I think" or "I believe" (and thus, as it were, into descriptions of *my* inner life) will become clearer in another place. (Solipsism.)

Page 12

25. It is sometimes said that animals do not talk because they lack the mental capacity. And this means: "they do not think, and that is why they do not talk." But--they simply do not talk. Or to put it better: they do not use language--if we except the most primitive forms of language.--Commanding, questioning, recounting, chatting, are as much a part of our natural history as walking, eating, drinking, playing.

Page 12

26. One thinks that learning language consists in giving names to objects. Viz, to human beings, to shapes, to colours, to pains, to

moods, to numbers, etc.. To repeat--naming is something like attaching a label to a thing. One can say that this is preparatory to the use of a word. But *what* is it a preparation *for*?

27. "We name things and then we can talk about them: can refer to them in talk."--As if what we did next were given with the mere act of naming. As if there were only one thing called "talking about a thing". Whereas in fact we do the most various things with our sentences. Think of exclamations alone, with their completely different functions.

Water!
Away!
Ow!
Help!
Fine!
No!

Are you inclined still to call these words "names of objects"?

In languages (2) and (8) there was no such thing as asking something's name. This, with its correlate, ostensive definition, is, we might say, a language-game on its own. That is really to say: we are brought up, trained, to ask: "What is that called?"--upon which the name is given. And there is also a language-game of inventing a name for something, and hence of saying, "This is...." and then using the new name. (Thus, for example, children give names to their dolls and then talk about them and to them. Think in this connexion how singular is the use of a person's name to *call* him!)

28. Now one can ostensively define a proper name, the name of a colour, the name of a material, a numeral, the name of a point of the compass and so on. The definition of the number two, "That is called 'two'"--pointing to two nuts--is perfectly exact.--But how can two be defined like that? The person one gives the definition to doesn't know what one wants to call "two"; he will suppose that "two" is the name given to *this* group of nuts!--He *may* suppose this; but perhaps he does not. He might make the opposite mistake; when I want to assign a name to this group of nuts, he might understand it as a numeral. And he might equally well take the name of a person, of which I give an ostensive definition, as that of a colour, of a race, or even of a point

of the compass. That is to say: an ostensive definition can be variously interpreted in *every* case.

29. Perhaps you say: two can only be ostensively defined in *this* way: "This *number* is called 'two'". For the word "number" here shews what place in language, in grammar, we assign to the word. But this means that the word "number" must be explained before the ostensive definition can be understood.--The word "number" in the definition does indeed shew this place; does shew the post at which we station the word. And we can prevent misunderstandings by saying: "This *colour* is called so-and-so", "This *length* is called so-and-so", and so on. That is to say: misunderstandings are sometimes averted in this way. But is there only *one* way of taking the word "colour" or "length"?--Well, they just need defining.--Defining, then, by means of other words! And what about the last definition in this chain? (Do not say: "There isn't a 'last' definition". That is just as if you chose to say: "There isn't a last house in this road; one can always build an additional one".)

Whether the word "number" is necessary in the ostensive definition depends on whether without it the other person takes the definition otherwise than I wish. And that will depend on the circumstances under which it is given, and on the person I give it to.

And how he 'takes' the definition is seen in the use that he makes of the word defined.

Could one define the word "red" by pointing to something that was *not red*? That would be as if one were supposed to explain the word "modest" to someone whose English was weak, and one pointed to an arrogant man and said "That man is *not* modest". That it is ambiguous is no argument against such a method of definition. Any definition can be misunderstood.

But it might well be asked: are we still to call this "definition"?--For, of course, even if it has the same practical consequences, the same *effect* on the learner, it plays a different part in the calculus from what we ordinarily call "ostensive definition" of the word "red".

30. So one might say: the ostensive definition explains the use--the meaning--of the word when the overall role of the word in language is clear. Thus if I know that someone means to explain a colour-word to me the ostensive definition "That is called 'sepia'" will help me to understand the word.--And you can say this, so long as

you do not forget that all sorts of problems attach to the words "to know" or "to be clear".

One has already to know (or be able to do) something in order to be capable of asking a thing's name. But what does one have to know?

31. When one shews someone the king in chess and says: "This is the king", this does not tell him the use of this piece--unless he already knows the rules of the game up to this last point: the shape of the king. You could imagine his having learnt the rules of the game without ever having been shewn an actual piece. The shape of the chessman corresponds here to the sound or shape of a word.

One can also imagine someone's having learnt the game without ever learning or formulating rules. He might have learnt quite simple board-games first, by watching, and have progressed to more and more complicated ones. He too might be given the explanation "This is the king",--if, for instance, he were being shewn chessmen of a shape he was not used to. This explanation again only tells him the use of the piece because, as we might say, the place for it was already prepared. Or even: we shall only say that it tells him the use, if the place is already prepared. And in this case it is so, not because the person to whom we give the explanation already knows rules, but because in another sense he is already master of a game.

Consider this further case: I am explaining chess to someone; and I begin by pointing to a chessman and saying: "This is the king; it can move like this,... and so on."--In this case we shall say: the words "This is the king" (or "This is called the 'king'") are a definition only if the learner already 'knows what a piece in a game is'. That is, if he has already played other games, or has watched other people playing 'and understood'--*and similar things*. Further, only under these conditions will he be able to ask relevantly in the course of learning the game: "What do you call this?"--that is, this piece in a game.

We may say: only someone who already knows how to do something with it can significantly ask a name.

And we can imagine the person who is asked replying: "Settle the name yourself"--and now the one who asked would have to manage everything for himself.

32. Someone coming into a strange country will sometimes learn the language of the inhabitants from ostensive definitions that they give him; and he will often have to *guess* the meaning of these definitions; and will guess sometimes right, sometimes wrong.

And now, I think, we can say: Augustine describes the learning

of human language as if the child came into a strange country and did not understand the language of the country; that is, as if it already had a language, only not this one. Or again: as if the child could already *think*, only not yet speak. And "think" would here mean something like "talk to itself".

33. Suppose, however, someone were to object: "It is not true that you must already be master of a language in order to understand an ostensive definition: all you need--of course!--is to know or guess what the person giving the explanation is pointing to. That is, whether for example to the shape of the object, or to its colour, or to its number, and so on."--And what does 'pointing to the shape', 'pointing to the colour' consist in? Point to a piece of paper.--And now point to its shape--now to its colour--now to its number (that sounds queer).--How did you do

it?--You will say that you 'meant' a different thing each time you pointed. And if I ask how that is done, you will say you concentrated your attention on the colour, the shape, etc. But I ask again: how is *that* done?

Page 16

Suppose someone points to a vase and says "Look at that marvellous blue--the shape isn't the point."--Or: "Look at the marvellous shape--the colour doesn't matter." Without doubt you will do something *different* when you act upon these two invitations. But do you always do the *same* thing when you direct your attention to the colour? Imagine various different cases. To indicate a few:

Page 16

"Is this blue the same as the blue over there? Do you see any difference?"--

Page 16

You are mixing paint and you say "It's hard to get the blue of this sky."

Page 16

"It's turning fine, you can already see blue sky again."

Page 16

"Look what different effects these two blues have."

Page 16

"Do you see the blue book over there? Bring it here."

Page 16

"This blue signal-light means...."

Page 16

"What's this blue called?--Is it 'indigo'?"

You sometimes attend to the colour by putting your hand up to keep the outline from view; or by not looking at the outline of the thing; sometimes by staring at the object and trying to remember where you saw that colour before.

Page 16

You attend to the shape, sometimes by tracing it, sometimes by screwing up your eyes so as not to see the colour clearly, and in many other ways. I want to say: This is the sort of thing that happens *while* one 'directs one's attention to this or that'. But it isn't these things by

Page Break 17

themselves that make us say someone is attending to the shape, the colour, and so on. Just as a move in chess doesn't consist simply in moving a piece in such-and-such a way on the board--nor yet in one's thoughts and feelings as one makes the move: but in the circumstances that we call "playing a game of chess", "solving a chess problem", and so on.

Page 17

34. But suppose someone said: "I always do the same thing when I attend to the shape: my eye follows the outline and I feel...". And suppose this person to give someone else the ostensive definition "That is called a 'circle'", pointing to a circular object and having all these experiences--cannot his hearer still interpret the definition differently, even though he sees the other's eyes following the outline, and even though he feels what the other feels? That is to say: this 'interpretation' may also consist in how he now makes use of the word; in what he points to, for example, when told: "Point to a circle".--For neither the expression "to intend the definition in such-and-such a way" nor the expression "to interpret the definition in such-and-such a way" stands for a process which accompanies the giving and hearing of the definition.

Page 17

35. There are, of course, what can be called "characteristic experiences" of pointing to (e.g.) the shape. For example, following the outline with one's finger or with one's eyes as one points.--But *this* does not happen in all cases in which I 'mean the shape', and no more does any other one characteristic process occur in all these cases.--Besides, even if something of the sort did recur in all cases, it would still depend on the circumstances--that is, on what happened before and after the pointing--whether we should say "He pointed to the shape and not to the colour".

Page 17

For the words "to point to the shape", "to mean the shape", and so on, are not used in the same way as *these*: "to point to this book (not to that one)", "to point to the chair, not to the table", and so on.--Only think how differently we *learn* the use of the words "to point to this thing", "to point to that thing", and on the other hand "to point to the colour, not the shape", "to mean the colour", and so on.

Page 17

To repeat: in certain cases, especially when one points 'to the shape' or 'to the number' there are characteristic experiences and ways of pointing--'characteristic' because they recur often (not always) when shape or number are

'meant'. But do you also know of an experience characteristic of pointing to a piece in a game *as a piece in a game*?

Page Break 18

All the same one can say: "I mean that this *piece* is called the 'king', not this particular bit of wood I am pointing to". (Recognizing, wishing, remembering, etc..)

Page 18

36. And we do here what we do in a host of similar cases: because we cannot specify any *one* bodily action which we call pointing to the shape (as opposed, for example, to the colour), we say that a *spiritual* [mental, intellectual] activity corresponds to these words.

Page 18

Where our language suggests a body and there is none: there, we should like to say, is a *spirit*.

Page 18

37. What is the relation between name and thing named?--Well, what *is* it? Look at language-game (2) or at another one: there you can see the sort of thing this relation consists in. This relation may also consist, among many other things, in the fact that hearing the name calls before our mind the picture of what is named; and it also consists, among other things, in the name's being written on the thing named or being pronounced when that thing is pointed at.

Page 18

What is it to *mean* the words "*That is blue*" at one time as a statement about the object one is pointing to--at another as an explanation of the word "blue"? Well, in the second case one really means "That is called 'blue'".--Then can one at one time mean the word "is" as "is called" and the word "blue" as "'blue'", and another time mean "is" really as "is"?

Page 18

It is also possible for someone to get an explanation of the words out of what was intended as a piece of information. [Marginal note: Here lurks a crucial superstition.]

Page 18

Can I say "bububu" and mean "If it doesn't rain I shall go for a walk"?--It is only in a language that I can mean something by something. This shews clearly that the grammar of "to mean" is not like that of the expression "to imagine" and the like.

Page 18

38. But what, for example, is the word "this" the name of in language-game (8) or the word "that" in the ostensive definition "that is called...."?--If you do not want to produce confusion you will do best not to call these words names at all.--Yet, strange to say, the word "this" has been called the only *genuine* name; so that anything else we call a name was one only in an inexact, approximate sense.

Page 18

This queer conception springs from a tendency to sublime the logic of our language--as one might put it. The proper answer to it is: we call very different things "names"; the word "name" is used to

Page Break 19

characterize many different kinds of use of a word, related to one another in many different ways;--but the kind of use that "this" has is not among them.

Page 19

It is quite true that, in giving an ostensive definition for instance, we often point to the object named and say the name. And similarly, in giving an ostensive definition for instance, we say the word "this" while pointing to a thing. And also the word "this" and a name often occupy the same position in a sentence. But it is precisely characteristic of a name that it is defined by means of the demonstrative expression "That is N" (or "That is called 'N'"). But do we also give the definitions: "That is called 'this'", or "This is called 'this'"?

Page 19

This is connected with the conception of naming as, so to speak, an occult process. Naming appears as a *queer* connexion of a word with an object.--And you really get such a queer connexion when the philosopher tries to bring out *the* relation between name and thing by staring at an object in front of him and repeating a name or even the word "this" innumerable times. For philosophical problems arise when language *goes on holiday*. And *here* we may indeed fancy naming to be some remarkable act of mind, as it were a baptism of an object. And we can also say the word "this" *to* the object, as it were *address* the object as "this"--a queer use of this word, which doubtless only occurs in doing philosophy.

39. But why does it occur to one to want to make precisely this word into a name, when it evidently is *not* a name?--That is just the reason. For one is tempted to make an objection against what is ordinarily called a name. It can be put like this: *a name ought really to signify a simple*. And for this one might perhaps give the following reasons: The word "Excalibur", say, is a proper name in the ordinary sense. The sword Excalibur consists of parts combined in a particular way. If they are combined differently Excalibur does not exist. But it is clear that the sentence "Excalibur has a sharp blade" makes *sense* whether Excalibur is still whole or is broken up. But if "Excalibur" is the name of an object, this object no longer exists when Excalibur is broken in pieces; and as no object would then correspond to the name it would have no meaning. But then the sentence "Excalibur has a sharp blade" would contain a word that had no meaning, and hence the sentence would be nonsense. But it does make sense; so there must always be something corresponding to the words of which it consists. So the word "Excalibur" must disappear when the sense is

analysed and its place be taken by words which name simples. It will be reasonable to call these words the real names.

40. Let us first discuss *this* point of the argument: that a word has no meaning if nothing corresponds to it.--It is important to note that the word "meaning" is being used illicitly if it is used to signify the thing that 'corresponds' to the word. That is to confound the meaning of a name with the *bearer* of the name. When Mr. N. N. dies one says that the bearer of the name dies, not that the meaning dies. And it would be nonsensical to say that, for if the name ceased to have meaning it would make no sense to say "Mr. N. N. is dead."

41. In §15 we introduced proper names into language (8). Now suppose that the tool with the name "N" is broken. Not knowing this, A gives B the sign "N". Has this sign meaning now or not?--What is B to do when he is given it?--We have not settled anything about this. One might ask: what *will* he do? Well, perhaps he will stand there at a loss, or shew A the pieces. Here one *might* say: "N" has become meaningless; and this expression would mean that the sign "N" no longer had a use in our language-game (unless we gave it a new one). "N" might also become meaningless because, for whatever reason, the tool was given another name and the sign "N" no longer used in the language-game.--But we could also imagine a convention whereby B has to shake his head in reply if A gives him the sign belonging to a tool that is broken.--In this way the command "N" might be said to be given a place in the language-game even when the tool no longer exists, and the sign "N" to have meaning even when its bearer ceases to exist.

42. But has for instance a name which has *never* been used for a tool also got a meaning in that game?--Let us assume that "X" is such a sign and that A gives this sign to B--well, even such signs could be given a place in the language-game, and B might have, say, to answer them too with a shake of the head. (One could imagine this as a sort of joke between them.)

43. For a *large* class of cases--though not for all--in which we employ the word "meaning" it can be defined thus: the meaning of a word is its use in the language.

And the *meaning* of a name is sometimes explained by pointing to its *bearer*.

44. We said that the sentence "Excalibur has a sharp blade" made sense even when Excalibur was broken in pieces. Now this is so because in this language-game a name is also used in the absence of its bearer. But we can imagine a language-game with names (that is, with signs which we should certainly include among names) in which they are used only in the presence of the bearer; and so could *always* be replaced by a demonstrative pronoun and the gesture of pointing.

45. The demonstrative "this" can never be without a bearer. It might be said: "so long as there is a *this*, the word 'this' has a meaning too, whether *this* is simple or complex."--But that does not make the word into a name. On the contrary: for a name is not used with, but only explained by means of, the gesture of pointing.

46. What lies behind the idea that names really signify simples?--

Socrates says in the *Theaetetus*: "If I make no mistake, I have heard some people say this: there is no definition of the primary elements--so to speak--out of which we and everything else are composed; for everything that exists†1 in its own right can only be *named*, no other determination is possible, neither that it *is* nor that it *is not*..... But what exists†1 in its own right has to be..... named without any other determination. In consequence it is impossible to give an account of any primary element; for it, nothing is possible but the bare name; its name is all it has. But just as what consists of these primary elements is itself complex, so the names of the elements become descriptive language by being compounded together. For the essence of speech is the composition of names."

Both Russell's 'individuals' and my 'objects' (*Tractatus Logico-Philosophicus*) were such primary elements.

47. But what are the simple constituent parts of which reality is composed?--What are the simple constituent parts of a chair?--The bits of wood of which it is made? Or the molecules, or the atoms?--"Simple" means: not composite. And here the point is: in what sense 'composite'? It makes no sense at all to speak absolutely of the 'simple parts of a chair'.

Again: Does my visual image of this tree, of this chair, consist of parts? And what are its simple component parts? Multi-colouredness is one kind of complexity; another is, for example, that of a broken outline composed of straight bits. And a curve can be said to be composed of an ascending and a descending segment.

If I tell someone without any further explanation: "What I see before me now is composite", he will have the right to ask: "What do you mean by 'composite'? For there are all sorts of things that that can mean!"--The question "Is what you see composite?" makes good sense if it is already established what kind of complexity--that is, which particular use of the word--is in question. If it had been laid down that the visual image of a tree was to be called "composite" if one saw not just a single trunk, but also branches, then the question "Is the visual image of this tree simple or composite?", and the question "What are its simple component parts?", would have a clear sense--a clear use. And of course the answer to the second question is not "The branches" (that would be an answer to the *grammatical* question: "What are here called 'simple component parts'?") but rather a description of the individual branches.

But isn't a chessboard, for instance, obviously, and absolutely, composite?--You are probably thinking of the composition out of thirty-two white and thirty-two black squares. But could we not also say, for instance, that it was composed of the colours black and white and the schema of squares? And if there are quite different ways of looking at it, do you still want to say that the chessboard is absolutely 'composite'?--Asking "Is this object composite?" *outside* a particular language-game is like what a boy once did, who had to say whether the verbs in certain sentences were in the active or passive voice, and who racked his brains over the question whether the verb "to sleep" meant something active or passive.

We use the word "composite" (and therefore the word "simple") in an enormous number of different and differently related ways. (Is the colour of a square on a chessboard simple, or does it consist of pure white and pure yellow? And is white simple, or does it consist of the colours of the rainbow?--Is this length of 2 cm. simple, or does it consist of two parts, each 1 cm. long? But why not of one bit 3 cm. long, and one bit 1 cm. long measured in the opposite direction?)

To the *philosophical* question: "Is the visual image of this tree

composite, and what are its component parts?" the correct answer is: "That depends on what you understand by 'composite'." (And that is of course not an answer but a rejection of the question.)

48. Let us apply the method of §2 to the account in the *Theaetetus*. Let us consider a language-game for which this account is really valid. The language serves to describe combinations of coloured squares on a surface. The squares form a complex like a chessboard. There are red, green, white and black squares. The words of the language are (correspondingly) "R", "G", "W", "B", and a sentence is a series of these words. They describe an

arrangement of squares in the order:

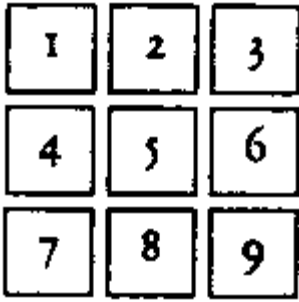

And so for instance the sentence "RRBGGGRWW" describes an arrangement of this sort:

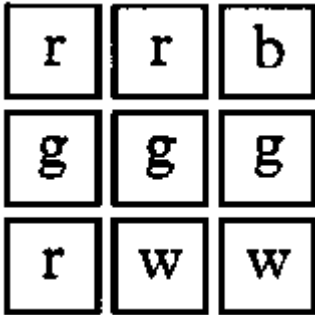

Here the sentence is a complex of names, to which corresponds a complex of elements. The primary elements are the coloured squares. "But are these simple?"--I do not know what else you would have me call "the simples", what would be more natural in this language-game. But under other circumstances I should call a monochrome square "composite", consisting perhaps of two rectangles, or of the elements colour and shape. But the concept of complexity might also be so extended that a smaller area was said to be 'composed' of a greater area and another one subtracted from it. Compare the 'composition of

Page Break 24

forces', the 'division' of a line by a point outside it; these expressions shew that we are sometimes even inclined to conceive the smaller as the result of a composition of greater parts, and the greater as the result of a division of the smaller.

Page 24

But I do not know whether to say that the figure described by our sentence consists of four or of nine elements! Well, does the sentence consist of four letters or of nine?--And which are *its* elements, the types of letter, or the letters? Does it matter which we say, so long as we avoid misunderstandings in any particular case?

Page 24

49. But what does it mean to say that we cannot define (that is, describe) these elements, but only name them? This might mean, for instance, that when in a limiting case a complex consists of only *one* square, its description is simply the name of the coloured square.

Page 24

Here we might say--though this easily leads to all kinds of philosophical superstition--that a sign "R" or "B", etc. may be sometimes a word and sometimes a proposition. But whether it 'is a word or a proposition' depends on the situation in which it is uttered or written. For instance, if A has to describe complexes of coloured squares to B and he uses the word "R" *alone*, we shall be able to say that the word is a description--a proposition. But if he is memorizing the words and their meanings, or if he is teaching someone else the use of the words and uttering them in the course of ostensive teaching, we shall not say that they are propositions. In this situation the word "R", for instance, is not a description; it *names* an element--but it would be queer to make that a reason for saying that an element can *only* be named! For naming and describing do not stand on the same level: naming is a preparation for description. Naming is so far not a move in the language-game--any more than putting a piece in its place on the board is a move in chess. We may say: *nothing* has so far been done, when a thing has been named. It has not even *got* a name except in the language-game. This was what Frege meant too, when he said that a word had meaning only as part of a sentence.

Page 24

50. What does it mean to say that we can attribute neither being nor non-being to elements?--One might say: if everything that we call "being" and "non-being" consists in the existence and non-existence of connexions between elements, it makes no sense to speak of an element's being (non-being); just as when everything that we call

"destruction" lies in the separation of elements, it makes no sense to speak of the destruction of an element.

Page Break 25

Page 25

One would, however, like to say: existence cannot be attributed to an element, for if it did not *exist*, one could not even name it and so one could say nothing at all of it.--But let us consider an analogous case. There is *one* thing of which one can say neither that it is one metre long, nor that it is not one metre long, and that is the standard metre in Paris.--But this is, of course, not to ascribe any extraordinary property to it, but only to mark its peculiar role in the language-game of measuring with a metre-rule.--Let us imagine samples of colour being preserved in Paris like the standard metre. We define: "sepia" means the colour of the standard sepia which is there kept hermetically sealed. Then it will make no sense to say of this sample either that it is of this colour or that it is not.

Page 25

We can put it like this: This sample is an instrument of the language used in ascriptions of colour. In this language-game it is not something that is represented, but is a means of representation.--And just this goes for an element in language-game (48) when we name it by uttering the word "R": this gives this object a role in our language-game; it is now a *means* of representation. And to say "If it did not *exist*, it could have no name" is to say as much and as little as: if this thing did not exist, we could not use it in our language-game.--What looks as if it *had* to exist, is part of the language. It is a paradigm in our language-game; something with which comparison is made. And this may be an important observation; but it is none the less an observation concerning our language-game--our method of representation.

Page 25

51. In describing language-game (48) I said that the words "R", "B", etc. corresponded to the colours of the squares. But what does this correspondence consist in; in what sense can one say that certain colours of squares correspond to these signs? For the account in (48) merely set up a connexion between those signs and certain words of our language (the names of colours).--Well, it was presupposed that the use of the signs in the language-game would be taught in a different way, in particular by pointing to paradigms. Very well; but what does it mean to say that in the *technique of using the language* certain elements correspond to the signs?--Is it that the person who is describing the complexes of coloured squares always says "R" where there is a red square; "B" when there is a black one, and so on? But what if he goes wrong in the description and mistakenly says "R" where he sees a black square--what is the criterion by which this is a *mistake*?--Or does "R"s standing for a red square consist in this, that when the

Page Break 26

people whose language it is use the sign "R" a red square always comes before their minds?

Page 26

In order to see more clearly, here as in countless similar cases, we must focus on the details of what goes on; must look at them *from close to*.

Page 26

52. If I am inclined to suppose that a mouse has come into being by spontaneous generation out of grey rags and dust, I shall do well to examine those rags very closely to see how a mouse may have hidden in them, how it may have got there and so on. But if I am convinced that a mouse cannot come into being from these things, then this investigation will perhaps be superfluous.

Page 26

But first we must learn to understand what it is that opposes such an examination of details in philosophy.

Page 26

53. Our language-game (48) has *various* possibilities; there is a variety of cases in which we should say that a sign in the game was the name of a square of such-and-such a colour. We should say so if, for instance, we knew that the people who used the language were taught the use of the signs in such-and-such a way. Or if it were set down in writing, say in the form of a table, that this element corresponded to this sign, and if the table were used in teaching the language and were appealed to in certain disputed cases.

Page 26

We can also imagine such a table's being a tool in the use of the language. Describing a complex is then done like this: the person who describes the complex has a table with him and looks up each element of the complex in it and passes from this to the sign (and the one who is given the description may also use a table to translate it into a picture of coloured squares). This table might be said to take over here the role of memory and association in other cases. (We do not usually carry out the order "Bring me a red flower" by looking up the colour red in a table of colours and then bringing a flower of the colour that we find in the table; but when it is a question of choosing or

mixing a particular shade of red, we do sometimes make use of a sample or table.)

Page 26

If we call such a table the expression of a rule of the language-game, it can be said that what we call a rule of a language-game may have very different roles in the game.

Page 26

54. Let us recall the kinds of case where we say that a game is played according to a definite rule.

Page Break 27

Page 27

The rule may be an aid in teaching the game. The learner is told it and given practice in applying it.--Or it is an instrument of the game itself.--Or a rule is employed neither in the teaching nor in the game itself; nor is it set down in a list of rules. One learns the game by watching how others play. But we say that it is played according to such-and-such rules because an observer can read these rules off from the practice of the game--like a natural law governing the play.--But how does the observer distinguish in this case between players' mistakes and correct play?--There are characteristic signs of it in the players' behaviour. Think of the behaviour characteristic of correcting a slip of the tongue. It would be possible to recognize that someone was doing so even without knowing his language.

Page 27

55. "What the names in language signify must be indestructible; for it must be possible to describe the state of affairs in which everything destructible is destroyed. And this description will contain words; and what corresponds to these cannot then be destroyed, for otherwise the words would have no meaning." I must not saw off the branch on which I am sitting.

Page 27

One might, of course, object at once that this description would have to except itself from the destruction.--But what corresponds to the separate words of the description and so cannot be destroyed if it is true, is what gives the words their meaning--is that without which they would have no meaning.--In a sense, however, this man is surely what corresponds to his name. But he is destructible, and his name does not lose its meaning when the bearer is destroyed.--An example of something corresponding to the name, and without which it would have no meaning, is a paradigm that is used in connexion with the name in the language-game.

Page 27

56. But what if no such sample is part of the language, and we *bear in mind* the colour (for instance) that a word stands for?--"And if we bear it in mind then it comes before our mind's eye when we utter the word. So, if it is always supposed to be possible for us to remember it, it must be in itself indestructible."--But what do we regard as the criterion for remembering it right?--When we work with a sample instead of our memory there are circumstances in which we say that the sample has changed colour and we judge of this by memory. But can we not sometimes speak of a darkening (for example) of our memory-image? Aren't we as much at the mercy of memory as of a sample? (For someone might feel like saying: "If we

Page Break 28

had no memory we should be at the mercy of a sample".)--Or perhaps of some chemical reaction. Imagine that you were supposed to paint a particular colour "C", which was the colour that appeared when the chemical substances X and Y combined.--Suppose that the colour struck you as brighter on one day than on another; would you not sometimes say: "I must be wrong, the colour is certainly the same as yesterday"? This shews that we do not always resort to what memory tells us as the verdict of the highest court of appeal.

Page 28

57. "Something red can be destroyed, but red cannot be destroyed, and that is why the meaning of the word 'red' is independent of the existence of a red thing."--Certainly it makes no sense to say that the colour red is torn up or pounded to bits. But don't we say "The red is vanishing"? And don't clutch at the idea of our always being able to bring red before our mind's eye even when there is nothing red any more. That is just as if you chose to say that there would still always be a chemical reaction producing a red flame.--For suppose you cannot remember the colour any more?--When we forget which colour this is the name of, it loses its meaning for us; that is, we are no longer able to play a particular language-game with it. And the situation then is comparable with that in which we have lost a paradigm which was an instrument of our language.

Page 28

58. "I want to restrict the term '*name*' to what cannot occur in the combination 'X exists'.--Thus one cannot say 'Red exists', because if there were no red it could not be spoken of at all."--Better: If "X exists" is meant simply to say: "X" has a meaning,--then it is not a proposition which treats of X, but a proposition about our use of

language, that is, about the use of the word "X".

Page 28

It looks to us as if we were saying something about the nature of red in saying that the words "Red exists" do not yield a sense. Namely that red does exist 'in its own right'. The same idea--that this is a metaphysical statement about red--finds expression again when we say such a thing as that red is timeless, and perhaps still more strongly in the word "indestructible".

Page 28

But what we really *want* is simply to take "Red exists" as the statement: the word "red" has a meaning. Or perhaps better: "Red does not exist" as "'Red' has no meaning". Only we do not want to say that that expression *says* this, but that *this* is what it would have to be saying *if* it meant anything. But that it contradicts itself in the attempt

Page Break 29

to say it--just because red exists 'in its own right'. Whereas the only contradiction lies in something like this: the proposition looks as if it were about the colour, while it is supposed to be saying something about the use of the word "red".--In reality, however, we quite readily say that a particular colour exists; and that is as much as to say that something exists that has that colour. And the first expression is no less accurate than the second; particularly where 'what has the colour' is not a physical object.

Page 29

59. "A *name* signifies only what is an *element* of reality. What cannot be destroyed; what remains the same in all changes."--But what is that?--Why, it swam before our minds as we said the sentence! This was the very expression of a quite particular image: of a particular picture which we want to use. For certainly experience does not shew us these elements. We see *component parts* of something composite (of a chair, for instance). We say that the back is part of the chair, but is in turn itself composed of several bits of wood; while a leg is a simple component part. We also see a whole which changes (is destroyed) while its component parts remain unchanged. These are the materials from which we construct that picture of reality.

Page 29

60. When I say: "My broom is in the corner",--is this really a statement about the broomstick and the brush? Well, it could at any rate be replaced by a statement giving the position of the stick and the position of the brush. And this statement is surely a further analysed form of the first one.--But why do I call it "further analysed"?--Well, if the broom is there, that surely means that the stick and brush must be there, and in a particular relation to one another; and this was as it were hidden in the sense of the first sentence, and is *expressed* in the analysed sentence. Then does someone who says that the broom is in the corner really mean: the broomstick is there, and so is the brush, and the broomstick is fixed in the brush?--If we were to ask anyone if he meant this he would probably say that he had not thought specially of the broomstick or specially of the brush at all. And that would be the *right* answer, for he meant to speak neither of the stick nor of the brush in particular. Suppose that, instead of saying "Bring me the broom", you said "Bring me the broomstick and the brush which is fitted on to it."!--Isn't the answer: "Do you want the broom? Why do you put it so oddly?"--Is he going to understand the further analysed sentence better?--This sentence, one might say, achieves the same as the ordinary one, but in a more roundabout way.--

Page Break 30

Imagine a language-game in which someone is ordered to bring certain objects which are composed of several parts, to move them about, or something else of the kind. And two ways of playing it: in one (a) the composite objects (brooms, chairs, tables, etc.) have names, as in (15); in the other (b) only the parts are given names and the wholes are described by means of them.--In what sense is an order in the second game an analysed form of an order in the first? Does the former lie concealed in the latter, and is it now brought out by analysis?--True, the broom is taken to pieces when one separates broomstick and brush; but does it follow that the order to bring the broom also consists of corresponding parts?

Page 30

61. "But all the same you will not deny that a particular order in (a) means the same as one in (b); and what would you call the second one, if not an analysed form of the first?"--Certainly I too should say that an order in (a) had the same meaning as one in (b); or, as I expressed it earlier: they achieve the same. And this means that if I were shewn an order in (a) and asked: "Which order in (b) means the same as this?" or again "Which order in (b) does this contradict?" I should give such-and-such an answer. But that is not to say that we have come to a *general* agreement about the use of the expression "to have the same meaning" or "to achieve the same". For it can be asked in what cases we say: "These are merely two forms of the same game."

Page 30

62. Suppose for instance that the person who is given the orders in (a) and (b) has to look up a table co-ordinating names and pictures before bringing what is required. Does he do *the same* when he carries out an order in (a) and the corresponding one in (b)?--Yes and no. You may say: "The *point* of the two orders is the same". I should say so too.--But it is not everywhere clear what should be called the 'point' of an order. (Similarly one may say of certain objects that they have this or that purpose. The essential thing is that this is a *lamp*, that it serves to give light;--that it is an ornament to the room, fills an empty space, etc., is not essential. But there is not always a sharp distinction between essential and inessential.)

Page 30

63. To say, however, that a sentence in (b) is an 'analysed' form of one in (a) readily seduces us into thinking that the former is the more fundamental form; that it alone shews what is meant by the other, and so on. For example, we think: If you have only the unanalysed form you miss the analysis; but if you know the analysed form that

Page Break 31

gives you everything.--But can I not say that an aspect of the matter is lost on you in the *latter* case as well as the former?

Page 31

64. Let us imagine language game (48) altered so that names signify not monochrome squares but rectangles each consisting of two such squares. Let such a rectangle, which is half red half green, be called "U"; a half green half white one, "V"; and so on. Could we not imagine people who had names for such combinations of colour, but not for the individual colours? Think of the cases where we say: "This arrangement of colours (say the French tricolor) has a quite special character."

Page 31

In what sense do the symbols of this language-game stand in need of analysis? How far is it even *possible* to replace this language-game by (48)?--It is just *another* language-game; even though it is related to (48).

Page 31

65. Here we come up against the great question that lies behind all these considerations.--For someone might object against me: "You take the easy way out! You talk about all sorts of language-games, but have nowhere said what the essence of a language-game, and hence of language, is: what is common to all these activities, and what makes them into language or parts of language. So you let yourself off the very part of the investigation that once gave you yourself most headache, the part about the *general form of propositions* and of language."

Page 31

And this is true.--Instead of producing something common to all that we call language, I am saying that these phenomena have no one thing in common which makes us use the same word for all,--but that they are *related* to one another in many different ways. And it is because of this relationship, or these relationships, that we call them all "language". I will try to explain this.

Page 31

66. Consider for example the proceedings that we call "games". I mean board-games, card-games, ball-games, Olympic games, and so on. What is common to them all?--Don't say: "There *must* be something common, or they would not be called 'games'"--but *look and see* whether there is anything common to all.--For if you look at them you will not see something that is common to *all*, but similarities, relationships, and a whole series of them at that. To repeat: don't think, but look!--Look for example at board-games, with their multifarious relationships. Now pass to card-games; here you find many correspondences with the first group, but many common

Page Break 32

features drop out, and others appear. When we pass next to ball-games, much that is common is retained, but much is lost.--Are they all 'amusing'? Compare chess with noughts and crosses. Or is there always winning and losing, or competition between players? Think of patience. In ball games there is winning and losing; but when a child throws his ball at the wall and catches it again, this feature has disappeared. Look at the parts played by skill and luck; and at the difference between skill in chess and skill in tennis. Think now of games like ring-a-ring-a-roses; here is the element of amusement, but how many other characteristic features have disappeared! And we can go through the many, many other groups of games in the same way; can see how similarities crop up and disappear.

Page 32

And the result of this examination is: we see a complicated network of similarities overlapping and criss-crossing: sometimes overall similarities, sometimes similarities of detail.

Page 32

67. I can think of no better expression to characterize these similarities than "family resemblances"; for the various resemblances between members of a family: build, features, colour of eyes, gait, temperament, etc. etc. overlap and criss-cross in the same way.--And I shall say: 'games' form a family.

Page 32

And for instance the kinds of number form a family in the same way. Why do we call something a "number"? Well, perhaps because it has a--direct--relationship with several things that have hitherto been called number; and this can be said to give it an indirect relationship to other things we call the same name. And we extend our concept of number as in spinning a thread we twist fibre on fibre. And the strength of the thread does not reside in the fact that some one fibre runs through its whole length, but in the overlapping of many fibres.

Page 32

But if someone wished to say: "There is something common to all these constructions--namely the disjunction of all their common properties"--I should reply: Now you are only playing with words. One might as well say: "Something runs through the whole thread--namely the continuous overlapping of those fibres".

Page 32

68. "All right: the concept of number is defined for you as the logical sum of these individual interrelated concepts: cardinal numbers, rational numbers, real numbers, etc.; and in the same way the concept of a game as the logical sum of a corresponding set of sub-concepts."--It need not be so. For I *can* give the concept 'number' rigid limits

Page Break 33

in this way, that is, use the word "number" for a rigidly limited concept, but I can also use it so that the extension of the concept is *not* closed by a frontier. And this is how we do use the word "game". For how is the concept of a game bounded? What still counts as a game and what no longer does? Can you give the boundary? No. You can *draw* one; for none has so far been drawn. (But that never troubled you before when you used the word "game".)

Page 33

"But then the use of the word is unregulated, the 'game' we play with it is unregulated."--It is not everywhere circumscribed by rules; but no more are there any rules for how high one throws the ball in tennis, or how hard; yet tennis is a game for all that and has rules too.

Page 33

69. How should we explain to someone what a game is? I imagine that we should describe *games* to him, and we might add: "This *and similar things* are called 'games'". And do we know any more about it ourselves? Is it only other people whom we cannot tell exactly what a game is?--But this is not ignorance. We do not know the boundaries because none have been drawn. To repeat, we can draw a boundary--for a special purpose. Does it take that to make the concept usable? Not at all! (Except for that special purpose.) No more than it took the definition: 1 pace = 75 cm. to make the measure of length 'one pace' usable. And if you want to say "But still, before that it wasn't an exact measure", then I reply: very well, it was an inexact one.--Though you still owe me a definition of exactness.

Page 33

Someone says to me: "Shew the children a game." I teach them gaming with dice, and the other says "I didn't mean that sort of game." Must the exclusion of the game with dice have come before his mind when he gave me the order?

Page 33

70. "But if the concept 'game' is uncircumscribed like that, you don't really know what you mean by a 'game'."--When I give the description: "The ground was quite covered with plants"--do you want to say I don't know what I am talking about until I can give a definition of a plant?

Page 33

My meaning would be explained by, say, a drawing and the words "The ground looked roughly like this". Perhaps I even say "it looked *exactly* like this."--Then were just *this* grass and *these* leaves there, arranged just like this? No, that is not what it means. And I should not accept any picture as exact in *this* sense.

Page Break 34

Page 34

71. One might say that the concept 'game' is a concept with blurred edges.--"But is a blurred concept a concept at all?"--Is an indistinct photograph a picture of a person at all? Is it even always an advantage to replace an indistinct picture by a sharp one? Isn't the indistinct one often exactly what we need?

Page 34

Frege compares a concept to an area and says that an area with vague boundaries cannot be called an area at all. This presumably means that we cannot do anything with it.--But is it senseless to say: "Stand roughly there"? Suppose that I were standing with someone in a city square and said that. As I say it I do not draw any kind of boundary, but perhaps point with my hand--as if I were indicating a particular *spot*. And this is just how one might explain to someone what a game is. One gives examples and intends them to be taken in a particular way.--I do not, however, mean by this that he is supposed to see in those examples that common thing which I--for some reason--was unable to express; but that he is now to *employ* those examples in a particular way. Here giving examples is not an *indirect* means of explaining--in default of a better. For any general definition can be misunderstood too. The point is that *this* is how we play the game. (I mean the language-game with the word "game".)

Page 34

72. *Seeing what is common.* Suppose I shew someone various multi-coloured pictures, and say: "The colour you see in all these is called 'yellow ochre'".--This is a definition, and the other will get to understand it by looking for and seeing what is common to the pictures. Then he can look *at*, can point *to*, the common thing.

Page 34

Compare with this a case in which I shew him figures of different shapes all painted the same colour, and say: "What these have in common is called 'yellow ochre'".

Page 34

And compare this case: I shew him samples of different shades of blue and say: "The colour that is common to all these is what I call 'blue'".

Page 34

73. When someone defines the names of colours for me by pointing to samples and saying "This colour is called 'blue', this 'green'...." this case can be compared in many respects to putting a table in my hands, with the words written under the colour-samples.--Though this comparison may mislead in many ways.--One is now inclined to extend the comparison: to have understood the definition means to have in one's mind an idea of the thing defined, and that is a sample or picture. So if I am shewn various different leaves and told

Page Break 35

"This is called a 'leaf'", I get an idea of the shape of a leaf, a picture of it in my mind.--But what does the picture of a leaf look like when it does not shew us any particular shape, but 'what is common to all shapes of leaf'? Which shade is the 'sample in my mind' of the colour green--the sample of what is common to all shades of green?

Page 35

"But might there not be such 'general' samples? Say a schematic leaf, or a sample of *pure* green?"--Certainly there might. But for such a schema to be understood as a *schema*, and not as the shape of a particular leaf, and for a slip of pure green to be understood as a sample of all that is greenish and not as a sample of pure green--this in turn resides in the way the samples are used.

Page 35

Ask yourself: what *shape* must the sample of the colour green be? Should it be rectangular? Or would it then be the sample of a green rectangle?--So should it be 'irregular' in shape? And what is to prevent us then from regarding it--that is, from using it--only as a sample of irregularity of shape?

Page 35

74. Here also belongs the idea that if you see this leaf as a sample of 'leaf shape in general' you *see* it differently from someone who regards it as, say, a sample of this particular shape. Now this might well be so--though it is not so--for it would only be to say that, as a matter of experience, if you *see* the leaf in a particular way, you use it in such-and-such a way or according to such-and-such rules. Of course, there is such a thing as seeing in *this* way or *that*; and there are also cases where whoever sees a sample like *this* will in general use it in *this* way, and whoever sees it otherwise in another way. For example, if you see the schematic drawing of a cube as a plane figure consisting of a square and two rhombi you will, perhaps, carry out the order "Bring me something like this" differently from someone who sees the picture three-dimensionally.

Page 35

75. What does it mean to know what a game is? What does it mean, to know it and not be able to say it? Is this knowledge somehow equivalent to an unformulated definition? So that if it were formulated I should be able to recognize it as the expression of my knowledge? Isn't my knowledge, my concept of a game, completely expressed in the explanations that I could give? That is, in my describing examples of various kinds of game; shewing how all sorts of other games can be constructed on the analogy of these; saying that I should scarcely include this or this among games; and so on.

76. If someone were to draw a sharp boundary I could not acknowledge it as the one that I too always wanted to draw, or had drawn in my mind. For I did not want to draw one at all. His concept can then be said to be not the same as mine, but akin to it. The kinship is that of two pictures, one of which consists of colour patches with vague contours, and the other of patches similarly shaped and distributed, but with clear contours. The kinship is just as undeniable as the difference.

77. And if we carry this comparison still further it is clear that the degree to which the sharp picture *can* resemble the blurred one depends on the latter's degree of vagueness. For imagine having to sketch a sharply defined picture 'corresponding' to a blurred one. In the latter there is a blurred red rectangle: for it you put down a sharply defined one. Of course--several such sharply defined rectangles can be drawn to correspond to the indefinite one.--But if the colours in the original merge without a hint of any outline won't it become a hopeless task to draw a sharp picture corresponding to the blurred one? Won't you then have to say: "Here I might just as well draw a circle or heart as a rectangle, for all the colours merge. Anything--and nothing--is right."--And this is the position you are in if you look for definitions corresponding to our concepts in aesthetics or ethics.

In such a difficulty always ask yourself: How did we *learn* the meaning of this word ("good" for instance)? From what sort of examples? in what language-games? Then it will be easier for you to see that the word must have a family of meanings.

78. Compare *knowing* and *saying*:

how many feet high Mont Blanc is--
how the word "game" is used--
how a clarinet sounds.

If you are surprised that one can know something and not be able to say it, you are perhaps thinking of a case like the first. Certainly not of one like the third.

79. Consider this example. If one says "Moses did not exist", this may mean various things. It may mean: the Israelites did not have a *single* leader when they withdrew from Egypt--or: their leader was not called Moses--or: there cannot have been anyone who accomplished all that the Bible relates of Moses--or: etc. etc.--We may say, following Russell: the name "Moses" can be defined by

means of various descriptions. For example, as "the man who led the Israelites through the wilderness", "the man who lived at that time and place and was then called 'Moses'", "the man who as a child was taken out of the Nile by Pharaoh's daughter" and so on. And according as we assume one definition or another the proposition "Moses did not exist" acquires a different sense, and so does every other proposition about Moses.--And if we are told "N did not exist", we do ask: "What do you mean? Do you want to say..... or..... etc.?"

But when I make a statement about Moses,--am I always ready to substitute some one of these descriptions for "Moses"? I shall perhaps say: By "Moses" I understand the man who did what the Bible relates of Moses, or at any rate a good deal of it. But how much? Have I decided how much must be proved false for me to give up my proposition as false? Has the name "Moses" got a fixed and unequivocal use for me in all possible cases?--Is it not the case that I have, so to speak, a whole series of props in readiness, and am ready to lean on one if another should be taken from under me and vice versa?--Consider another case. When I say "N is dead", then something like the following may hold for the meaning of the name "N": I believe that a human being has lived, whom I (1) have seen in such-and-such places, who (2) looked like this (pictures), (3) has done such-and-such things, and (4) bore the name "N" in social life.--Asked what I understand by "N", I should enumerate all or some of these points, and different ones on different occasions. So my definition of "N" would perhaps be "the man of whom all this is true".--But if some point now proves false?--Shall I be prepared to declare the proposition "N is dead" false--even if it is only something which strikes me as incidental that has turned out false? But where are the bounds of the incidental?--If I had given a definition of the name in such a case, I should now be ready to alter it.

And this can be expressed like this: I use the name "N" without a *fixed* meaning. (But that detracts as little from its usefulness, as it detracts from that of a table that it stands on four legs instead of three and so sometimes wobbles.)

Should it be said that I am using a word whose meaning I don't know, and so am talking nonsense?--Say what you choose, so long as it does not prevent you from seeing the facts. (And when you see them there is a good deal that you will not say.)

(The fluctuation of scientific definitions: what to-day counts as an

observed concomitant of a phenomenon will to-morrow be used to define it.)

80. I say "There is a chair". What if I go up to it, meaning to fetch it, and it suddenly disappears from sight?--"So it wasn't a chair, but some kind of illusion".--But in a few moments we see it again and are able to touch it and so on.--"So the chair was there after all and its disappearance was some kind of illusion".--But suppose that after a time it disappears again--or seems to disappear. What are we to say now? Have you rules ready for such cases--rules saying whether one may use the word "chair" to include this kind of thing? But do we miss them when we use the word "chair"; and are we to say that we do not really attach any meaning to this word, because we are not equipped with rules for every possible application of it?

81. F. P. Ramsey once emphasized in conversation with me that logic was a 'normative science'. I do not know exactly what he had in mind, but it was doubtless closely related to what only dawned on me later: namely, that in philosophy we often *compare* the use of words with games and calculi which have fixed rules, but cannot say that someone who is using language *must* be playing such a game.--But if you say that our languages only *approximate* to such calculi you are standing on the very brink of a misunderstanding. For then it may look as if what we were talking about were an *ideal* language. As if our logic were, so to speak, a logic for a vacuum.--Whereas logic does not treat of language--or of thought--in the sense in which a natural science treats of a natural phenomenon, and the most that can be said is that we *construct* ideal languages. But here the word "ideal" is liable to mislead, for it sounds as if these languages were better, more perfect, than our everyday language; and as if it took the logician to shew people at last what a proper sentence looked like.

All this, however, can only appear in the right light when one has attained greater clarity about the concepts of understanding, meaning, and thinking. For it will then also become clear what can lead us (and did lead me) to think that if anyone utters a sentence and *means* or *understands* it he is operating a calculus according to definite rules.

82. What do I call 'the rule by which he proceeds'?--The hypothesis that satisfactorily describes his use of words, which we observe; or the rule which he looks up when he uses signs; or the one which he

gives us in reply if we ask him what his rule is?--But what if observation does not enable us to see any clear rule, and the question brings none to light?--For he did indeed give me a definition when I asked him what he understood by "N", but he was prepared to withdraw and alter it.--So how am I to determine the rule according to which he is playing? He does not know it himself.--Or, to ask a better question: What meaning is the expression "the rule by which he proceeds" supposed to have left to it here?

83. Doesn't the analogy between language and games throw light here? We can easily imagine people amusing themselves in a field by playing with a ball so as to start various existing games, but playing many without finishing them and in between throwing the ball aimlessly into the air, chasing one another with the ball and bombarding one another for a joke and so on. And now someone says: The whole time they are playing a ball-game and following definite rules at every throw.

And is there not also the case where we play and--make up the rules as we go along? And there is even one where we alter them--as we go along.

84. I said that the application of a word is not everywhere bounded by rules. But what does a game look like that is everywhere bounded by rules? whose rules never let a doubt creep in, but stop up all the cracks where it might?--Can't we imagine a rule determining the application of a rule, and a doubt which *it* removes--and so on?

But that is not to say that we are in doubt because it is possible for us to *imagine* a doubt. I can easily imagine someone always doubting before he opened his front door whether an abyss did not yawn behind it, and making sure about it before he went through the door (and he might on some occasion prove to be right)--but that does not make me doubt in the same case.

Page 39

85. A rule stands there like a sign-post.--Does the sign-post leave no doubt open about the way I have to go? Does it shew which direction I am to take when I have passed it; whether along the road or the footpath or cross-country? But where is it said which way I am to follow it; whether in the direction of its finger or (e.g.) in the opposite one?--And if there were, not a single sign-post, but a chain of adjacent ones or of chalk marks on the ground--is there only *one* way of interpreting them?--So I can say, the sign-post does after all

Page Break 40

leave no room for doubt. Or rather: it sometimes leaves room for doubt and sometimes not. And now this is no longer a philosophical proposition, but an empirical one.

Page 40

86. Imagine a language-game like (2) played with the help of a table. The signs given to B by A are now written ones. B has a table; in the first column are the signs used in the game, in the second pictures of building stones. A shews B such a written sign; B looks it up in the table, looks at the picture opposite, and so on. So the table is a rule which he follows in executing orders.--One learns to look the picture up in the table by receiving a training, and part of this training consists perhaps in the pupil's learning to pass with his finger horizontally from left to right; and so, as it were, to draw a series of horizontal lines on the table.

Page 40

Suppose different ways of reading a table were now introduced; one time, as above, according to the schema:

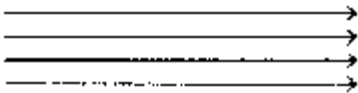

another time like this:

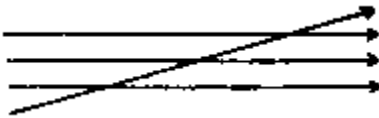

or in some other way.--Such a schema is supplied with the table as the rule for its use.

Page 40

Can we not now imagine further rules to explain *this* one? And, on the other hand, was that first table incomplete without the schema of arrows? And are other tables incomplete without their schemata?

Page 40

87. Suppose I give this explanation: "I take 'Moses' to mean the man, if there was such a man, who led the Israelites out of Egypt, whatever he was called then and whatever he may or may not have done besides."--But similar doubts to those about "Moses" are possible about the words of this explanation (what are you calling "Egypt", whom the "Israelites" etc.?). Nor would these questions come to an end when we got down to words like "red", "dark", "sweet".--"But then how does an explanation help me to understand,

Page Break 41

if after all it is not the final one? In that case the explanation is never completed; so I still don't understand what he means, and never shall!"--As though an explanation as it were hung in the air unless supported by another one. Whereas an explanation may indeed rest on another one that has been given, but none stands in need of another--unless *we* require it to prevent a misunderstanding. One might say: an explanation serves to remove or to avert a misunderstanding--one, that is, that would occur but for the explanation; not every one that I can imagine.

Page 41

It may easily look as if every doubt merely *revealed* an existing gap in the foundations; so that secure understanding is only possible if we first doubt everything that *can* be doubted, and then remove all these doubts.

Page 41

The sign-post is in order--if, under normal circumstances, it fulfils its purpose.

Page 41

88. If I tell someone "Stand roughly here"--may not this explanation work perfectly? And cannot every other

one fail too?

Page 41

But isn't it an inexact explanation?--Yes; why shouldn't we call it "inexact"? Only let us understand what "inexact" means. For it does not mean "unusable". And let us consider what we call an "exact" explanation in contrast with this one. Perhaps something like drawing a chalk line round an area? Here it strikes us at once that the line has breadth. So a colour-edge would be more exact. But has this exactness still got a function here: isn't the engine idling? And remember too that we have not yet defined what is to count as overstepping this exact boundary; how, with what instruments, it is to be established. And so on.

Page 41

We understand what it means to set a pocket watch to the exact time or to regulate it to be exact. But what if it were asked: is this exactness ideal exactness, or how nearly does it approach the ideal?--Of course, we can speak of measurements of time in which there is a different, and as we should say a greater, exactness than in the measurement of time by a pocket-watch; in which the words "to set the clock to the exact time" have a different, though related meaning, and 'to tell the time' is a different process and so on.--Now, if I tell someone: "You should come to dinner more punctually; you know it begins at one o'clock exactly"--is there really no question of *exactness* here? because it is possible to say: "Think of the determination of time in the laboratory or the observatory; *there* you see what 'exactness' means"?

Page Break 42

Page 42

"Inexact" is really a reproach, and "exact" is praise. And that is to say that what is inexact attains its goal less perfectly than what is more exact. Thus the point here is what we call "the goal". Am I inexact when I do not give our distance from the sun to the nearest foot, or tell a joiner the width of a table to the nearest thousandth of an inch?

Page 42

No *single* ideal of exactness has been laid down; we do not know what we should be supposed to imagine under this head--unless you yourself lay down what is to be so called. But you will find it difficult to hit upon such a convention; at least any that satisfies you.

Page 42

89. These considerations bring us up to the problem: In what sense is logic something sublime?

Page 42

For there seemed to pertain to logic a peculiar depth--a universal significance. Logic lay, it seemed, at the bottom of all the sciences.--For logical investigation explores the nature of all things. It seeks to see to the bottom of things and is not meant to concern itself whether what actually happens is this or that.--It takes its rise, not from an interest in the facts of nature, nor from a need to grasp causal connexions: but from an urge to understand the basis, or essence, of everything empirical. Not, however, as if to this end we had to hunt out new facts; it is, rather, of the essence of our investigation that we do not seek to learn anything *new* by it. We want to *understand* something that is already in plain view. For *this* is what we seem in some sense not to understand.

Page 42

Augustine says in the *Confessions* "quid est ergo tempus? si nemo ex me quaerat scio; si quaerenti explicare velim, nescio".--This could not be said about a question of natural science ("What is the specific gravity of hydrogen?" for instance). Something that we know when no one asks us, but no longer know when we are supposed to give an account of it, is something that we need to *remind* ourselves of. (And it is obviously something of which for some reason it is difficult to remind oneself.)

Page 42

90. We feel as if we had to *penetrate* phenomena: our investigation, however, is directed not towards phenomena, but, as one might say, towards the '*possibilities*' of phenomena. We remind ourselves, that is to say, of the *kind of statement* that we make about phenomena. Thus Augustine recalls to mind the different statements that are made about the duration, past present or future, of events. (These are, of course, not *philosophical* statements about time, the past, the present and the future.)

Page Break 43

Page 43

Our investigation is therefore a grammatical one. Such an investigation sheds light on our problem by clearing misunderstandings away. Misunderstandings concerning the use of words, caused, among other things, by certain analogies between the forms of expression in different regions of language.--Some of them can be removed by substituting one form of expression for another; this may be called an "analysis" of our forms of expression, for

the process is sometimes like one of taking a thing apart.

Page 43

91. But now it may come to look as if there were something like a final analysis of our forms of language, and so a *single* completely resolved form of every expression. That is, as if our usual forms of expression were, essentially, unanalysed; as if there were something hidden in them that had to be brought to light. When this is done the expression is completely clarified and our problem solved.

Page 43

It can also be put like this: we eliminate misunderstandings by making our expressions more exact; but now it may look as if we were moving towards a particular state, a state of complete exactness; and as if this were the real goal of our investigation.

Page 43

92. This finds expression in questions as to the essence of language, of propositions, of thought.--For if we too in these investigations are trying to understand the essence of language--its function, its structure,--yet *this* is not what those questions have in view. For they see in the essence, not something that already lies open to view and that becomes surveyable by a rearrangement, but something that lies *beneath* the surface. Something that lies within, which we see when we look *into* the thing, and which an analysis digs out.

Page 43

'The essence is hidden from us': this is the form our problem now assumes. We ask: "*What is language?*", "*What is a proposition?*" And the answer to these questions is to be given once for all; and independently of any future experience.

Page 43

93. One person might say "A proposition is the most ordinary thing in the world" and another: "A proposition--that's something very queer!"--And the latter is unable simply to look and see how propositions really work. The forms that we use in expressing ourselves about propositions and thought stand in his way.

Page 43

Why do we say a proposition is something remarkable? On the one hand, because of the enormous importance attaching to it. (And that is correct). On the other hand this, together with a misunderstanding

Page Break 44

of the logic of language, seduces us into thinking that something extraordinary, something unique, must be achieved by propositions.--*A misunderstanding makes* it look to us as if a proposition *did* something queer.

Page 44

94. 'A proposition is a queer thing!' Here we have in germ the subliming of our whole account of logic. The tendency to assume a pure intermediary between the propositional *signs* and the facts. Or even to try to purify, to sublime, the signs themselves.--For our forms of expression prevent us in all sorts of ways from seeing that nothing out of the ordinary is involved, by sending us in pursuit of chimeras.

Page 44

95. "Thought must be something unique". When we say, and *mean*, that such-and-such is the case, we--and our meaning--do not stop anywhere short of the fact; but we mean: *this--is--so*. But this paradox (which has the form of a truism) can also be expressed in this way: *Thought* can be of what is *not* the case.

Page 44

96. Other illusions come from various quarters to attach themselves to the special one spoken of here. Thought, language, now appear to us as the unique correlate, picture, of the world. These concepts: proposition, language, thought, world, stand in line one behind the other, each equivalent to each. (But what are these words to be used for now? The language-game in which they are to be applied is missing.)

Page 44

97. Thought is surrounded by a halo.--Its essence, logic, presents an order, in fact the a priori order of the world: that is, the order of *possibilities*, which must be common to both world and thought. But this order, it seems, must be *utterly simple*. It is *prior* to all experience, must run through all experience; no empirical cloudiness or uncertainty can be allowed to affect it--It must rather be of the purest crystal. But this crystal does not appear as an abstraction; but as something concrete, indeed, as the most concrete, as it were the *hardest* thing there is (*Tractatus Logico-Philosophicus* No. 5.5563).

Page 44

We are under the illusion that what is peculiar, profound, essential, in our investigation, resides in its trying to grasp the incomparable essence of language. That is, the order existing between the concepts of proposition, word, proof, truth, experience, and so on. This order is a *super-order* between--so to speak--*super-concepts*. Whereas, of course, if the words "language", "experience", "world", have a use, it must be as humble a one as that of the words

"table", "lamp", "door".

Page Break 45

Page 45

98. On the one hand it is clear that every sentence in our language 'is in order as it is'. That is to say, we are not *striving after* an ideal, as if our ordinary vague sentences had not yet got a quite unexceptionable sense, and a perfect language awaited construction by us.--On the other hand it seems clear that where there is sense there must be perfect order.--So there must be perfect order even in the vaguest sentence.

Page 45

99. The sense of a sentence--one would like to say--may, of course, leave this or that open, but the sentence must nevertheless have a definite sense. An indefinite sense--that would really not be a sense *at all*.--This is like: An indefinite boundary is not really a boundary at all. Here one thinks perhaps: if I say "I have locked the man up fast in the room--there is only one door left open"--then I simply haven't locked him in at all; his being locked in is a sham. One would be inclined to say here: "You haven't done anything at all". An enclosure with a hole in it is as good as *none*.--But is that true?

Page 45

100. "But still, it isn't a game, if there is some vagueness *in the rules*".--But *does* this prevent its being a game?--"Perhaps you'll call it a game, but at any rate it certainly isn't a perfect game." This means: it has impurities, and what I am interested in at present is the pure article.--But I want to say: we misunderstand the role of the ideal in our language. That is to say: we too should call it a game, only we are dazzled by the ideal and therefore fail to see the actual use of the word "game" clearly.

Page 45

101. We want to say that there can't be any vagueness in logic. The idea now absorbs us, that the ideal '*must*' be found in reality. Meanwhile we do not as yet see *how* it occurs there, nor do we understand the nature of this "must". We think it must be in reality; for we think we already see it there.

Page 45

102. The strict and clear rules of the logical structure of propositions appear to us as something in the background--hidden in the medium of the understanding. I already see them (even though through a medium): for I understand the propositional sign, I use it to say something.

Page 45

103. The ideal, as we think of it, is unshakable. You can never get outside it; you must always turn back. There is no outside; outside you cannot breathe.--Where does this idea come from? It is like a pair of glasses on our nose through which we see whatever we look at. It never occurs to us to take them off.

Page Break 46

Page 46

104. We predicate of the thing what lies in the method of representing it. Impressed by the possibility of a comparison, we think we are perceiving a state of affairs of the highest generality.

Page 46

105. When we believe that we must find that order, must find the ideal, in our actual language, we become dissatisfied with what are ordinarily called "propositions", "words", "signs".

Page 46

The proposition and the word that logic deals with are supposed to be something pure and clear-cut. And we rack our brains over the nature of the *real* sign.--It is perhaps the *idea* of the sign? or the idea at the present moment?

Page 46

106. Here it is difficult as it were to keep our heads up,--to see that we must stick to the subjects of our every-day thinking, and not go astray and imagine that we have to describe extreme subtleties, which in turn we are after all quite unable to describe with the means at our disposal. We feel as if we had to repair a torn spider's web with our fingers.

Page 46

107. The more narrowly we examine actual language, the sharper becomes the conflict between it and our requirement. (For the crystalline purity of logic was, of course, not a *result of investigation*: it was a requirement.) The conflict becomes intolerable; the requirement is now in danger of becoming empty.--We have got on to slippery ice where there is no friction and so in a certain sense the conditions are ideal, but also, just because of that, we are unable to walk. We want to walk: so we need *friction*. Back to the rough ground!

Faraday in *The Chemical History of a Candle*: "Water is one individual thing--it never changes."

108. We see that what we call "sentence" and "language" has not the formal unity that I imagined, but is the family of structures more or less related to one another.--But what becomes of logic now? Its rigour seems to be giving way here.--But in that case doesn't logic altogether disappear?--For how can it lose its rigour? Of course not by our bargaining any of its rigour out of it.--The *preconceived idea* of crystalline purity can only be removed by turning our whole examination round. (One might say: the axis of reference of our examination must be rotated, but about the fixed point of our real need.)

The philosophy of logic speaks of sentences and words in exactly the sense in which we speak of them in ordinary life when we say e.g.

"Here is a Chinese sentence", or "No, that only looks like writing; it is actually just an ornament" and so on.

We are talking about the spatial and temporal phenomenon of language, not about some non-spatial, non-temporal phantasm. [Note in margin: Only it is possible to be interested in a phenomenon in a variety of ways]. But we talk about it as we do about the pieces in chess when we are stating the rules of the game, not describing their physical properties.

The question "What is a word really?" is analogous to "What is a piece in chess?"

109. It was true to say that our considerations could not be scientific ones. It was not of any possible interest to us to find out empirically 'that, contrary to our preconceived ideas, it is possible to think such-and-such'--whatever that may mean. (The conception of thought as a gaseous medium.) And we may not advance any kind of theory. There must not be anything hypothetical in our considerations. We must do away with all *explanation*, and description alone must take its place. And this description gets its light, that is to say its purpose, from the philosophical problems. These are, of course, not empirical problems; they are solved, rather, by looking into the workings of our language, and that in such a way as to make us recognize those workings: *in despite of* an urge to misunderstand them. The problems are solved, not by giving new information, but by arranging what we have always known. Philosophy is a battle against the bewitchment of our intelligence by means of language.

110. "Language (or thought) is something unique"--this proves to be a superstition (*not* a mistake!), itself produced by grammatical illusions.

And now the impressiveness retreats to these illusions, to the problems.

111. The problems arising through a misinterpretation of our forms of language have the character of *depth*. They are deep disquietudes; their roots are as deep in us as the forms of our language and their significance is as great as the importance of our language.--Let us ask ourselves: why do we feel a grammatical joke to be *deep*? (And that is what the depth of philosophy is.)

112. A simile that has been absorbed into the forms of our language produces a false appearance, and this disquiets us. "But *this* isn't how it is!"--we say. "Yet *this* is how it has to *be*!"

113. "But *this* is how it is--" I say to myself over and over again. I feel as though, if only I could fix my gaze absolutely sharply on this fact, get it in focus, I must grasp the essence of the matter.

114. (*Tractatus Logico-Philosophicus*, 4.5): "The general form of propositions is: This is how things are."--That is the kind of proposition that one repeats to oneself countless times. One thinks that one is tracing the outline of the thing's nature over and over again, and one is merely tracing round the frame through which we look at it.

115. A *picture* held us captive. And we could not get outside it, for it lay in our language and language seemed to repeat it to us inexorably.

Page 48

116. When philosophers use a word--"knowledge", "being", "object", "I", "proposition", "name"--and try to grasp the *essence* of the thing, one must always ask oneself: is the word ever actually used in this way in the language-game which is its original home?--

Page 48

What *we* do is to bring words back from their metaphysical to their everyday use.

Page 48

117. You say to me: "You understand this expression, don't you? Well then--I am using it in the sense you are familiar with."--As if the sense were an atmosphere accompanying the word, which it carried with it into every kind of application.

Page 48

If, for example, someone says that the sentence "This is here" (saying which he points to an object in front of him) makes sense to him, then he should ask himself in what special circumstances this sentence is actually used. There it does make sense.

Page 48

118. Where does our investigation get its importance from, since it seems only to destroy everything interesting, that is, all that is great and important? (As it were all the buildings, leaving behind only bits of stone and rubble.) What we are destroying is nothing but houses of cards and we are clearing up the ground of language on which they stand.

Page 48

119. The results of philosophy are the uncovering of one or another piece of plain nonsense and of bumps that the understanding has got by running its head up against the limits of language. These bumps make us see the value of the discovery.

Page 48

120. When I talk about language (words, sentences, etc.) I must speak the language of every day. Is this language somehow too coarse and material for what we want to say? *Then how is another one to be*

Page Break 49

constructed?--And how strange that we should be able to do anything at all with the one we have!

Page 49

In giving explanations I already have to use language full-blown (not some sort of preparatory, provisional one); this by itself shews that I can adduce only exterior facts about language.

Page 49

Yes, but then how can these explanations satisfy us?--Well, your very questions were framed in this language; they had to be expressed in this language, if there was anything to ask!

Page 49

And your scruples are misunderstandings.

Page 49

Your questions refer to words; so I have to talk about words.

Page 49

You say: the point isn't the word, but its meaning, and you think of the meaning as a thing of the same kind as the word, though also different from the word. Here the word, there the meaning. The money, and the cow that you can buy with it. (But contrast: money, and its use.)

Page 49

121. One might think: if philosophy speaks of the use of the word "philosophy" there must be a second-order philosophy. But it is not so: it is, rather, like the case of orthography, which deals with the word "orthography" among others without then being second-order.

Page 49

122. A main source of our failure to understand is that we do not *command a clear view* of the use of our words.--Our grammar is lacking in this sort of perspicuity. A perspicuous representation produces just that understanding which consists in 'seeing connexions'. Hence the importance of finding and inventing *intermediate cases*.

Page 49

The concept of a perspicuous representation is of fundamental significance for us. It earmarks the form of account we give, the way we look at things. (Is this a 'Weltanschauung'?)

Page 49

123. A philosophical problem has the form: "I don't know my way about".

Page 49

124. Philosophy may in no way interfere with the actual use of language; it can in the end only describe it.

Page 49

For it cannot give it any foundation either.

Page 49

It leaves everything as it is.

Page 49

It also leaves mathematics as it is, and no mathematical discovery can advance it. A "leading problem of mathematical logic" is for us a problem of mathematics like any other.

Page Break 50

Page 50

125. It is the business of philosophy, not to resolve a contradiction by means of a mathematical or logico-mathematical discovery, but to make it possible for us to get a clear view of the state of mathematics that troubles us: the state of affairs *before* the contradiction is resolved. (And this does not mean that one is sidestepping a difficulty.)

Page 50

The fundamental fact here is that we lay down rules, a technique, for a game, and that then when we follow the rules, things do not turn out as we had assumed. That we are therefore as it were entangled in our own rules.

Page 50

This entanglement in our rules is what we want to understand (i.e. get a clear view of).

Page 50

It throws light on our concept of *meaning* something. For in those cases things turn out otherwise than we had meant, foreseen. That is just what we say when, for example, a contradiction appears: "I didn't mean it like that."

Page 50

The civil status of a contradiction, or its status in civil life: there is the philosophical problem.

Page 50

126. Philosophy simply puts everything before us, and neither explains nor deduces anything.--Since everything lies open to view there is nothing to explain. For what is hidden, for example, is of no interest to us.

Page 50

One might also give the name "philosophy" to what is possible *before* all new discoveries and inventions.

Page 50

127. The work of the philosopher consists in assembling reminders for a particular purpose.

Page 50

128. If one tried to advance *theses* in philosophy, it would never be possible to debate them, because everyone would agree to them.

Page 50

129. The aspects of things that are most important for us are hidden because of their simplicity and familiarity. (One is unable to notice something--because it is always before one's eyes.) The real foundations of his enquiry do not strike a man at all. Unless *that* fact has at some time struck him.--And this means: we fail to be struck by what, once seen, is most striking and most powerful.

Page 50

130. Our clear and simple language-games are not preparatory studies for a future regularization of language--as it were first approximations, ignoring friction and air-resistance. The language-games are rather set up as *objects of comparison* which are meant to throw light on the facts of our language by way not only of similarities, but also of dissimilarities.

Page Break 51

Page 51

131. For we can avoid ineptness or emptiness in our assertions only by presenting the model as what it is, as an object of comparison--as, so to speak, a measuring-rod; not as a preconceived idea to which reality *must* correspond. (The dogmatism into which we fall so easily in doing philosophy.)

Page 51

132. We want to establish an order in our knowledge of the use of language: an order with a particular end in view; one out of many possible orders; not *the* order. To this end we shall constantly be giving prominence to

distinctions which our ordinary forms of language easily make us overlook. This may make it look as if we saw it as our task to reform language.

Page 51

Such a reform for particular practical purposes, an improvement in our terminology designed to prevent misunderstandings in practice, is perfectly possible. But these are not the cases we have to do with. The confusions which occupy us arise when language is like an engine idling, not when it is doing work.

Page 51

133. It is not our aim to refine or complete the system of rules for the use of our words in unheard-of ways.

Page 51

For the clarity that we are aiming at is indeed *complete* clarity. But this simply means that the philosophical problems should *completely* disappear.

Page 51

The real discovery is the one that makes me capable of stopping doing philosophy when I want to.--The one that gives philosophy peace, so that it is no longer tormented by questions which bring *itself* in question.--Instead, we now demonstrate a method, by examples; and the series of examples can be broken off.--Problems are solved (difficulties eliminated), not a *single* problem.

Page 51

There is not *a* philosophical method, though there are indeed methods, like different therapies.

Page 51

134. Let us examine the proposition: "This is how things are."--How can I say that this is the general form of propositions?--It is first and foremost *itself* a proposition, an English sentence, for it has a subject and a predicate. But how is this sentence applied--that is, in our everyday language? For I got it from there and nowhere else.

Page 51

We may say, e.g.: "He explained his position to me, said that this was how things were, and that therefore he needed an advance". So far, then, one can say that that sentence stands for any statement. It is employed as a propositional *schema*, but *only* because it has the

Page Break 52

construction of an English sentence. It would be possible to say instead "such and such is the case", "this is the situation", and so on. It would also be possible here simply to use a letter, a variable, as in symbolic logic. But no one is going to call the letter "p" the general form of propositions. To repeat: "This is how things are" had that position only because it is itself what one calls an English sentence. But though it is a proposition, still it gets employed as a propositional variable. To say that this proposition agrees (or does not agree) with reality would be obvious nonsense. Thus it illustrates the fact that *one* feature of our concept of a proposition is, *sounding like a proposition*.

Page 52

135. But haven't we got a concept of what a proposition is, of what we take "proposition" to mean?--Yes; just as we also have a concept of what we mean by "game". Asked what a proposition is--whether it is another person or ourselves that we have to answer--we shall give examples and these will include what one may call inductively defined series of propositions. *This* is the kind of way in which we have such a concept as 'proposition'. (Compare the concept of a proposition with the concept of number.)

Page 52

136. At bottom, giving "This is how things are" as the general form of propositions is the same as giving the definition: a proposition is whatever can be true or false. For instead of "This is how things are" I could have said "This is true". (Or again "This is false".) But we have

'p' is true = p
'p' is false = not-p.

Page 52

And to say that a proposition is whatever can be true or false amounts to saying: we call something a proposition when *in our language* we apply the calculus of truth functions to it.

Page 52

Now it looks as if the definition--a proposition is whatever can be true or false--determined what a proposition was, by saying: what fits the concept 'true', or what the concept 'true' fits, is a proposition. So it is as if we had a concept of true and false, which we could use to determine what is and what is not a proposition. What *engages* with the concept of truth (as with a cogwheel), is a proposition.

Page 52

But this is a bad picture. It is as if one were to say "The king in chess is *the* piece that one can check." But

this can mean no more than that in our game of chess we only check the king. Just as the proposition that only a *proposition* can be true or false can say no more than

Page Break 53

that we only predicate "true" and "false" of what we call a proposition. And what a proposition is is in one sense determined by the rules of sentence formation (in English for example), and in another sense by the use of the sign in the language-game. And the use of the words "true" and "false" may be among the constituent parts of this game; and if so it *belongs* to our concept 'proposition' but does not *fit* it. As we might also say, check *belongs* to our concept of the king in chess (as so to speak a constituent part of it). To say that check did not *fit* our concept of the pawns, would mean that a game in which pawns were checked, in which, say, the players who lost their pawns lost, would be uninteresting or stupid or too complicated or something of the kind.

Page 53

137. What about learning to determine the subject of a sentence by means of the question "Who or what....?"--Here, surely, there is such a thing as the subject's 'fitting' this question; for otherwise how should we find out what the subject was by means of the question? We find it out much as we find out which letter of the alphabet comes after 'K' by saying the alphabet up to 'K' to ourselves. Now in what sense does 'L' fit on to this series of letters?--In *that* sense "true" and "false" could be said to fit propositions; and a child might be taught to distinguish between propositions and other expressions by being told "Ask yourself if you can say 'is true' after it. If these words fit, it's a proposition." (And in the same way one might have said: Ask yourself if you can put the words "*This* is how things are:" in front of it.)

Page 53

138. But can't the meaning of a word that I understand fit the sense of a sentence that I understand? Or the meaning of one word fit the meaning of another?--Of course, if the meaning is the *use* we make of the word, it makes no sense to speak of such 'fitting.' But we *understand* the meaning of a word when we hear or say it; we grasp it in a flash, and what we grasp in this way is surely something different from the 'use' which is extended in time!

Page 53

Must I *know* whether I understand a word? Don't I also sometimes imagine myself to understand a word (as I may imagine I understand a kind of calculation) and then realize that I did not understand it? ("I thought I knew what 'relative' and 'absolute' motion meant, but I see that I don't know.")

Page Break 54

Page 54

139. When someone says the word "cube" to me, for example, I know what it means. But can the whole *use* of the word come before my mind, when I *understand* it in this way?

Page 54

Well, but on the other hand isn't the meaning of the word also determined by this use? And can't these ways of determining meaning conflict? Can what we grasp *in a flash* accord with a use, fit or fail to fit it? And how can what is present to us in an instant, what comes before our mind in an instant, fit a *use*?

Page 54

What really comes before our mind when we *understand* a word?--Isn't it something like a picture? Can't it *be* a picture?

Page 54

Well, suppose that a picture does come before your mind when you hear the word "cube", say the drawing of a cube. In what sense can this picture fit or fail to fit a use of the word "cube"?--Perhaps you say: "It's quite simple;--if that picture occurs to me and I point to a triangular prism for instance, and say it is a cube, then this use of the word doesn't fit the picture."--But doesn't it fit? I have purposely so chosen the example that it is quite easy to imagine a *method of projection* according to which the picture does fit after all.

Page 54

The picture of the cube did indeed *suggest* a certain use to us, but it was possible for me to use it differently.

Page 54

(a) "I believe the right word in this case is....". Doesn't this shew that the meaning of a word is a something that comes before our mind, and which is, as it were, the exact picture we want to use here? Suppose I were choosing between the words "imposing", "dignified", "proud", "venerable"; isn't it as though I were choosing

between drawings in a portfolio?--No: the fact that one speaks of the *appropriate word* does not *shew* the existence of a something that etc.. One is inclined, rather, to speak of this picture-like something just because one can find a word appropriate; because one often chooses between words as between similar but not identical pictures; because pictures are often used instead of words, or to illustrate words; and so on.

Page 54

(b) I see a picture; it represents an old man walking up a steep path leaning on a stick.--How? Might it not have looked just the same if he had been sliding downhill in that position? Perhaps a Martian would describe the picture so. I do not need to explain why *we* do not describe it so.

Page Break 55

Page 55

140. Then what sort of mistake did I make; was it what we should like to express by saying: I should have thought the picture forced a particular use on me? How could I think that? What *did* I think? Is there such a thing as a picture, or something like a picture, that forces a particular application on us; so that my mistake lay in confusing one picture with another?--For we might also be inclined to express ourselves like this: we are at most under a psychological, not a logical, compulsion. And now it looks quite as if we knew of two kinds of case.

Page 55

What was the effect of my argument? It called our attention to (reminded us of) the fact that there are other processes, besides the one we originally thought of, which we should sometimes be prepared to call "applying the picture of a cube". So our 'belief that the picture forced a particular application upon us' consisted in the fact that only the one case and no other occurred to us. "There is another solution as well" means: there is something else that I am also prepared to call a "solution"; to which I am prepared to apply such-and-such a picture, such-and-such an analogy, and so on.

Page 55

What is essential is to see that the same thing can come before our minds when we hear the word and the application still be different. Has it the *same* meaning both times? I think we shall say not.

Page 55

141. Suppose, however, that not merely the picture of the cube, but also the method of projection comes before our mind?--How am I to imagine this?--Perhaps I see before me a schema shewing the method of projection: say a picture of two cubes connected by lines of projection.--But does this really get me any further? Can't I now imagine different applications of this schema too?--Well, yes, but then can't an *application come before my mind*?--It can: only we need to get clearer about our application of *this* expression. Suppose I explain various methods of projection to someone so that he may go on to apply them; let us ask ourselves when we should say that *the* method that I intend comes before his mind.

Page 55

Now clearly we accept two different kinds of criteria for this: on the one hand the picture (of whatever kind) that at some time or other comes before his mind; on the other, the application which--in the course of time--he makes of what he imagines. (And can't it be clearly seen here that it is absolutely inessential for the picture to exist in his imagination rather than as a drawing or model in front of him; or again as something that he himself constructs as a model?)

Page Break 56

Page 56

Can there be a collision between picture and application? There can, inasmuch as the picture makes us expect a different use, because people in general apply *this* picture like *this*.

Page 56

I want to say: we have here a *normal* case, and abnormal cases.

Page 56

142. It is only in normal cases that the use of a word is clearly prescribed; we know, are in no doubt, what to say in this or that case. The more abnormal the case, the more doubtful it becomes what we are to say. And if things were quite different from what they actually are--if there were for instance no characteristic expression of pain, of fear, of joy; if rule became exception and exception rule; or if both became phenomena of roughly equal frequency--this would make our normal language-games lose their point.--The procedure of putting a lump of cheese on a balance and fixing the price by the turn of the scale would lose its point if it frequently happened for such lumps to suddenly grow or shrink for no obvious reason. This remark will become clearer when we discuss such things as the relation of expression to feeling, and similar topics.

What we have to mention in order to explain the significance, I mean the importance, of a concept, are often extremely general facts of nature: such facts as are hardly ever mentioned because of their great generality.

143. Let us now examine the following kind of language-game: when A gives an order B has to write down series of signs according to a certain formation rule.

The first of these series is meant to be that of the natural numbers in decimal notation.--How does he get to understand this notation?--First of all series of numbers will be written down for him and he will be required to copy them. (Do not balk at the expression "series of numbers"; it is not being used wrongly here.) And here already there is a normal and an abnormal learner's reaction.--At first perhaps we guide his hand in writing out the series 0 to 9; but then the *possibility of getting him to understand* will depend on his going on to write it down independently.--And here we can imagine, e.g., that he does copy the figures independently, but not in the right order: he writes sometimes one sometimes another at random. And then communication stops at *that* point.--Or again, he makes '*mistakes*'

in the order.--The difference between this and the first case will of course be one of frequency.--Or he makes a *systematic* mistake; for example, he copies every other number, or he copies the series 0, 1, 2, 3, 4, 5,.... like this: 1, 0, 3, 2, 5, 4,..... Here we shall almost be tempted to say that he has understood *wrong*.

Notice, however, that there is no sharp distinction between a random mistake and a systematic one. That is, between what you are inclined to call "random" and what "systematic".

Perhaps it is possible to wean him from the systematic mistake (as from a bad habit). Or perhaps one accepts his way of copying and tries to teach him ours as an offshoot, a variant of his.--And here too our pupil's capacity to learn may come to an end.

144. What do I mean when I say "the pupil's capacity to learn *may* come to an end here"? Do I say this from my own experience? Of course not. (Even if I have had such experience.) Then what am I doing with that proposition? Well, I should like you to say: "Yes, it's true, you can imagine that too, that might happen too!"--But was I trying to draw someone's attention to the fact that he is capable of imagining that?--I wanted to put that picture before him, and his *acceptance* of the picture consists in his now being inclined to regard a given case differently: that is, to compare it with *this* rather than *that* set of pictures. I have changed his *way of looking at things*. (Indian mathematicians: "Look at this.")

145. Suppose the pupil now writes the series 0 to 9 to our satisfaction.--And this will only be the case when he is often successful, not if he does it right once in a hundred attempts. Now I continue the series and draw his attention to the recurrence of the first series in the units; and then to its recurrence in the tens. (Which only means that I use particular emphases, underline figures, write them one under another in such-and-such ways, and similar things.)--And now at some point he continues the series independently--or he does not.--But why do you say that? *so* much is obvious!--Of course; I only wished to say: the effect of any further *explanation* depends on his *reaction*.

Now, however, let us suppose that after some efforts on the teacher's part he continues the series correctly, that is, as we do it. So now we can say he has mastered the system.--But how far need he continue

the series for us to have the right to say that? Clearly you cannot state a limit here.

146. Suppose I now ask: "Has he understood the system when he continues the series to the hundredth place?" Or--if I should not speak of 'understanding' in connection with our primitive language-game: Has he got the system, if he continues the series correctly so far?--Perhaps you will say here: to have got the system (or, again, to understand it) can't consist in continuing the series up to *this* or *that* number: *that* is only applying one's understanding. The understanding itself is a state which is the *source* of the correct use.

What is one really thinking of here? Isn't one thinking of the derivation of a series from its algebraic formula? Or at least of something analogous?--But this is where we were before. The point is, we can think of more than *one* application of an algebraic formula; and every type of application can in turn be formulated algebraically; but naturally this does not get us any further.--The application is still a criterion of understanding.

Page 58

147. "But how can it be? When *I* say I understand the rule of a series, I am surely not saying so because I have *found out* that up to now I have applied the algebraic formula in such-and-such a way! In my own case at all events I surely know that I mean such-and-such a series; it doesn't matter how far I have actually developed it."--

Page 58

Your idea, then, is that you know the application of the rule of the series quite apart from remembering actual applications to particular numbers. And you will perhaps say: "Of course! For the series is infinite and the bit of it that I can have developed finite."

Page 58

148. But what does this knowledge consist in? Let me ask: *When* do you know that application? Always? day and night? or only when you are actually thinking of the rule? do you know it, that is, in the same way as you know the alphabet and the multiplication table? Or is what you call "knowledge" a state of consciousness or a process--say a thought of something, or the like?

Page 58

149. If one says that knowing the ABC is a state of the mind, one is thinking of a state of a mental apparatus (perhaps of the brain) by means of which we explain the *manifestations* of that knowledge. Such a state is called a disposition. But there are objections to speaking

Page Break 59

of a state of the mind here, inasmuch as there ought to be two different criteria for such a state: a knowledge of the construction of the apparatus, quite apart from what it does. (Nothing would be more confusing here than to use the words "conscious" and "unconscious" for the contrast between states of consciousness and dispositions. For this pair of terms covers up a grammatical difference.)

Page 59

150. The grammar of the word "knows" is evidently closely related to that of "can", "is able to". But also closely related to that of "understands". ('Mastery' of a technique,)

Page 59

(a) "Understanding a word": a state. But a *mental* state?--Depression, excitement, pain, are called mental states. Carry out a grammatical investigation as follows: we say

Page 59

"He was depressed the whole day".

Page 59

"He was in great excitement the whole day".

Page 59

"He has been in continuous pain since yesterday".--

We also say "Since yesterday I have understood this word". "Continuously", though?--To be sure, one can speak of an interruption of understanding. But in what cases? Compare: "When did your pains get less?" and "When did you stop understanding that word?"

Page 59

(b) Suppose it were asked: "*When* do you know how to play chess? All the time? or just while you are making a move? And the *whole* of chess during each move?--How queer that knowing how to play chess should take such a short time, and a game so much longer!

Page 59

151. But there is also *this* use of the word "to know": we say "Now I know!"--and similarly "Now I can do it!" and "Now I understand!"

Page 59

Let us imagine the following example: A writes series of numbers down; B watches him and tries to find a law for the sequence of numbers. If he succeeds he exclaims: "Now I can go on!"--So this capacity, this understanding, is something that makes its appearance in a moment. So let us try and see what it is that makes its appearance here.--A has written down the numbers 1, 5, 11, 19, 29; at this point B says he knows how to go on. What happened here? Various things may have happened; for example, while A was slowly putting one number

after another, B was occupied with trying various algebraic formulae on the numbers which had been written down. After A had written the number 19 B tried the formula $a_n = n^2 + n - 1$; and the next number confirmed his hypothesis.

Page Break 60

Page 60

Or again, B does not think of formulae. He watches A writing his numbers down with a certain feeling of tension, and all sorts of vague thoughts go through his head. Finally he asks himself: "What is the series of differences?" He finds the series 4, 6, 8, 10 and says: Now I can go on.

Page 60

Or he watches and says "Yes, I know *that* series"--and continues it, just as he would have done if A had written down the series 1, 3, 5, 7, 9.--Or he says nothing at all and simply continues the series. Perhaps he had what may be called the sensation "that's easy!". (Such a sensation is, for example, that of a light quick intake of breath, as when one is slightly startled.)

Page 60

152. But are the processes which I have described here *understanding*?

Page 60

"B understands the principle of the series" surely doesn't mean simply: the formula " $a_n = \dots$ " occurs to B. For it is perfectly imaginable that the formula should occur to him and that he should nevertheless not understand. "He understands" must have more in it than: the formula occurs to him. And equally, more than any of those more or less characteristic *accompaniments* or manifestations of understanding.

Page 60

153. We are trying to get hold of the mental process of understanding which seems to be hidden behind those coarser and therefore more readily visible accompaniments. But we do not succeed; or, rather, it does not get as far as a real attempt. For even supposing I had found something that happened in all those cases of understanding,--why should *it* be the understanding? And how can the process of understanding have been hidden, when I said "Now I understand" *because* I understood?! And if I say it is hidden--then how do I know what I have to look for? I am in a muddle.

Page 60

154. But wait--if "Now I understand the principle" does not mean the same as "The formula.... occurs to me" (or "I say the formula", "I write it down", etc.)--does it follow from this that I employ the sentence "Now I understand....." or "Now I can go on" as a description of a process occurring behind or side by side with that of saying the formula?

Page 60

If there has to be anything 'behind the utterance of the formula' it is *particular circumstances*, which justify me in saying I can go on--when the formula occurs to me.

Page Break 61

Page 61

Try not to think of understanding as a 'mental process' at all.--For *that* is the expression which confuses you. But ask yourself: in what sort of case, in what kind of circumstances, do we say, "Now I know how to go on," when, that is, the formula *has* occurred to me?--

Page 61

In the sense in which there are processes (including mental processes) which are characteristic of understanding, understanding is not a mental process.

Page 61

(A pain's growing more and less; the hearing of a tune or a sentence: these are mental processes.)

Page 61

155. Thus what I wanted to say was: when he suddenly knew how to go on, when he understood the principle, then possibly he had a special experience--and if he is asked: "What was it? What took place when you suddenly grasped the principle?" perhaps he will describe it much as we described it above--but for us it is *the circumstances* under which he had such an experience that justify him in saying in such a case that he understands, that he knows how to go on.

Page 61

156. This will become clearer if we interpolate the consideration of another word, namely "reading". First I need to remark that I am not counting the understanding of what is read as part of 'reading' for purposes of this investigation: reading is here the activity of rendering out loud what is written or printed; and also of writing from

dictation, writing out something printed, playing from a score, and so on.

Page 61

The use of this word in the ordinary circumstances of our life is of course extremely familiar to us. But the part the word plays in our life, and therewith the language-game in which we employ it, would be difficult to describe even in rough outline. A person, let us say an Englishman, has received at school or at home one of the kinds of education usual among us, and in the course of it has learned to read his native language. Later he reads books, letters, newspapers, and other things.

Page 61

Now what takes place when, say, he reads a newspaper?--His eye passes--as we say--along the printed words, he says them out loud--or only to himself; in particular he reads certain words by taking in their printed shapes as wholes; others when his eye has taken in the first syllables; others again he reads syllable by syllable, and an occasional one perhaps letter by letter.--We should also say that he had read a sentence if he spoke neither aloud nor to himself during the reading but was afterwards able to repeat the sentence word for word or nearly so.--He may attend to what he reads, or again--as we

Page Break 62

might put it--function as a mere reading-machine: I mean, read aloud and correctly without attending to what he is reading; perhaps with his attention on something quite different (so that he is unable to say what he has been reading if he is asked about it immediately afterwards).

Page 62

Now compare a beginner with this reader. The beginner reads the words by laboriously spelling them out.--Some however he guesses from the context, or perhaps he already partly knows the passage by heart. Then his teacher says that he is not really *reading* the words (and in certain cases that he is only pretending to read them).

Page 62

If we think of *this* sort of reading, the reading of a beginner, and ask ourselves what *reading* consists in, we shall be inclined to say: it is a special conscious activity of mind.

Page 62

We also say of the pupil: "Of course he alone knows if he is really reading or merely saying the words off by heart". (We have yet to discuss these propositions: "He alone knows....".)

Page 62

But I want to say: we have to admit that--as far as concerns uttering any *one* of the printed words--the same thing may take place in the consciousness of the pupil who is 'pretending' to read, as in that of the practised reader who is 'reading' it. The word "to read" is applied *differently* when we are speaking of the beginner and of the practised reader.--Now we should of course like to say: What goes on in that practised reader and in the beginner when they utter the word *can't* be the same. And if there is no difference in what they happen to be conscious of there must be one in the unconscious workings of their minds, or, again, in the brain.--So we should like to say: There are at all events two different mechanisms at work here. And what goes on in them must distinguish reading from not reading.--But these mechanisms are only hypotheses, models designed to explain, to sum up, what you observe.

Page 62

157. Consider the following case. Human beings or creatures of some other kind are used by us as reading-machines. They are trained for this purpose. The trainer says of some that they can already read, of others that they cannot yet do so. Take the case of a pupil who has so far not taken part in the training: if he is shewn a written word he will sometimes produce some sort of sound, and here and there it happens 'accidentally' to be roughly right. A third person hears this pupil on such an occasion and says: "He is reading". But the teacher says: "No, he isn't reading; that was just an accident".--But let us suppose that this pupil continues to react correctly to further words

Page Break 63

that are put before him. After a while the teacher says: "Now he can read!"--But what of that first word? Is the teacher to say: "I was wrong, and he *did* read it"--or: "He only began really to read later on"?--When did he begin to read? Which was the first word that he *read*? This question makes no sense here. Unless, indeed, we give a definition: "The first word that a person 'reads' is the first word of the first series of 50 words that he reads correctly" (or something of the sort).

Page 63

If on the other hand we use "reading" to stand for a certain experience of transition from marks to spoken sounds, then it certainly makes sense to speak of the *first* word that he really read. He can then say, e.g. "At this

word for the first time I had the feeling: 'now I am reading'."

Page 63

Or again, in the different case of a reading machine which translated marks into sounds, perhaps as a pianola does, it would be possible to say: "The machine *read* only after such-and-such had happened to it--after such-and-such parts had been connected by wires; the first word that it read was....".

Page 63

But in the case of the living reading-machine "reading" meant reacting to written signs in such-and-such ways. This concept was therefore quite independent of that of a mental or other mechanism.--Nor can the teacher here say of the pupil: "Perhaps he was already reading when he said that word". For there is no doubt about what he did.--The change when the pupil began to read was a change in his *behaviour*; and it makes no sense here to speak of 'a first word in his new state'.

Page 63

158. But isn't that only because of our too slight acquaintance with what goes on in the brain and the nervous system? If we had a more accurate knowledge of these things we should see what connexions were established by the training, and then we should be able to say when we looked into his brain: "Now he has *read* this word, now the reading connexion has been set up".--And it presumably *must* be like that--for otherwise how could we be so sure that there was such a connexion? That it is so is presumably a priori--or is it only probable? And how probable is it? Now, ask yourself: what do you *know* about these things?--But if it is a priori, that means that it is a form of account which is very convincing to us.

Page 63

159. But when we think the matter over we are tempted to say: the one real criterion for anybody's *reading* is the conscious act of reading, the act of reading the sounds off from the letters. "A man

Page Break 64

surely knows whether he is reading or only pretending to read!"--Suppose A wants to make B believe he can read Cyrillic script. He learns a Russian sentence by heart and says it while looking at the printed words as if he were reading them. Here we shall certainly say that A knows he is not reading, and has a sense of just this while pretending to read. For there are of course many more or less characteristic sensations in reading a printed sentence; it is not difficult to call such sensations to mind: think of sensations of hesitating, of looking closer, of misreading, of words following on one another more or less smoothly, and so on. And equally there are characteristic sensations in reciting something one has learnt by heart. In our example A will have none of the sensations that are characteristic of reading, and will perhaps have a set of sensations characteristic of cheating.

Page 64

160. But imagine the following case: We give someone who can read fluently a text that he never saw before. He reads it to us--but with the sensation of saying something he has learnt by heart (this might be the effect of some drug). Should we say in such a case that he was not really reading the passage? Should we here allow his sensations to count as the criterion for his reading or not reading?

Page 64

Or again: Suppose that a man who is under the influence of a certain drug is presented with a series of characters (which need not belong to any existing alphabet). He utters words corresponding to the number of the characters, as if they were letters, and does so with all the outward signs, and with the sensations, of reading. (We have experiences like this in dreams; after waking up in such a case one says perhaps: "It seemed to me as if I were reading a script, though it was not writing at all.") In such a case some people would be inclined to say the man was *reading* those marks. Others, that he was not.--Suppose he has in this way read (or interpreted) a set of five marks as *A B O V E*--and now we shew him the same marks in the reverse order and he reads *E V O B A*; and in further tests he always retains the same interpretation of the marks: here we should certainly be inclined to say he was making up an alphabet for himself *ad hoc* and then reading accordingly.

Page 64

161. And remember too that there is a continuous series of transitional cases between that in which a person repeats from memory what he is supposed to be reading, and that in which he spells out every word without being helped at all by guessing from the context or knowing by heart.

Page Break 65

Page 65

Try this experiment: say the numbers from 1 to 12. Now look at the dial of your watch and *read* them.--What was it that you called "reading" in the latter case? That is to say: what did you do, to make it into *reading*?

162. Let us try the following definition: You are reading when you *derive* the reproduction from the original. And by "the original" I mean the text which you read or copy; the dictation from which you write; the score from which you play; etc. etc.--Now suppose we have, for example, taught someone the Cyrillic alphabet, and told him how to pronounce each letter. Next we put a passage before him and he reads it, pronouncing every letter as we have taught him. In this case we shall very likely say that he derives the sound of a word from the written pattern by the rule that we have given him. And this is also a clear case of *reading*. (We might say that we had taught him the 'rule of the alphabet'.)

But why do we say that he has *derived* the spoken from the printed words? Do we know anything more than that we taught him how each letter should be pronounced, and that he then read the words out loud? Perhaps our reply will be: the pupil shews that he is using the rule we have given him to pass from the printed to the spoken words.--How this can be *shewn* becomes clearer if we change our example to one in which the pupil has to write out the text instead of reading it to us, has to make the transition from print to handwriting. For in this case we can give him the rule in the form of a table with printed letters in one column and cursive letters in the other. And he shews that he is deriving his script from the printed words by consulting the table.

163. But suppose that when he did this he always wrote *b* for *A*, *c* for *B*, *d* for *C*, and so on, and *a* for *Z*?--Surely we should call this too a derivation by means of the table.--He is using it now, we might say, according to the second schema in §86 instead of the first.

It would still be a perfectly good case of derivation according to the table, even if it were represented by a schema of arrows without any simple regularity.

Suppose, however, that he does not stick to a *single* method of transcribing, but alters his method according to a simple rule: if he has once written *n* for *A*, then he writes *o* for the next *A*, *p* for the next, and so on.--But where is the dividing line between this procedure and a random one?

But does this mean that the word "to derive" really has no meaning, since the meaning seems to disintegrate when we follow it up?

164. In case (162) the meaning of the word "to derive" stood out clearly. But we told ourselves that this was only a quite special case of deriving; deriving in a quite special garb, which had to be stripped from it if we wanted to see the essence of deriving. So we stripped those particular coverings off; but then deriving itself disappeared.--In order to find the real artichoke, we divested it of its leaves. For certainly (162) was a special case of deriving; what is essential to deriving, however, was not hidden beneath the surface of this case, but his 'surface' was one case out of the family of cases of deriving.

And in the same way we also use the word "to read" for a family of cases. And in different circumstances we apply different criteria for a person's reading.

The grammar of the expression "a quite particular" (atmosphere). One says "This face has a quite *particular* expression," and maybe looks for words to characterize it.

165. But surely--we should like to say--reading is a quite particular process! Read a page of print and you can see that something special is going on, something highly characteristic.--Well, what does go on when I read the page? I see printed words and I say words out loud. But, of course, that is not all, for I might see printed words and say words out loud and still not be reading. Even if the words which I say are those which, going by an existing alphabet, are *supposed* to be read off from the printed ones.--And if you say that reading is a particular experience, then it becomes quite unimportant whether or not you read according to some generally recognized alphabetical rule.--And what does the characteristic thing about the experience of reading consist in?--Here I should like to say: "The words that I utter *come* in a special way." That is, they do not come as they would if I were for example making them up.--They come of themselves.--But even that is not enough; for the sounds of words may *occur* to me while I

am looking at printed words, but that does not mean that I have read them.--In addition I might say here, neither do the spoken words occur to me as if, say, something reminded me of them. I should for example not wish to say: the printed word "nothing" always reminds me of the sound "nothing"--but the spoken words as it were slip in as one

Page Break 67

reads. And if I so much as look at a German printed word, there occurs a peculiar process, that of hearing the sound inwardly.

Page 67

166. I said that when one reads the spoken words come 'in a special way': but in what way? Isn't this a fiction? Let us look at individual letters and attend to the way the sound of the letter comes. Read the letter A.--Now, how did the sound come?--We have no idea what to say about it.--Now write a small Roman a.--How did the movement of the hand come as you wrote? Differently from the way the sound came in the previous experiment?--All I know is, I looked at the printed letter and wrote the cursive letter.--Now look at the mark



and let a sound occur to you as you do so; utter it. The sound 'U' occurred to me; but I could not say that there was any essential difference in the kind of way that sound *came*. The difference lay in the difference of situation. I had told myself beforehand that I was to let a sound occur to me; there was a certain tension present before the sound came. And I did not say 'U' automatically as I do when I look at the letter U. Further, that mark was not *familiar* to me in the way the letters of the alphabet are. I looked at it rather intently and with a certain interest in its shape; as I looked I thought of a reversed σ --Imagine having to use this mark regularly as a letter; so that you got used to uttering a particular sound at the sight of it, say the sound "sh". Can we say anything but that after a while this sound comes automatically when we look at the mark? That is to say: I no longer ask myself on seeing it "What sort of letter is that?"--nor, of course, do I tell myself "This mark makes me want to utter the sound 'sh'", nor yet "This mark somehow reminds me of the sound 'sh'".

Page 67

(Compare with this the idea that memory images are distinguished from other mental images by some special characteristic.)

Page 67

167. Now what is there in the proposition that reading is 'a quite particular process'? It presumably means that when we read *one* particular process takes place, which we recognize.--But suppose that I at one time read a sentence in print and at another write it in Morse code--is the mental process really the same?--On the other hand, however, there is certainly some uniformity in the experience of reading a page of print. For the process is a uniform one. And it is quite easy to understand that there is a difference between this process and one of, say, letting words occur to one at the sight of arbitrary marks.--For the mere look of a printed line is itself extremely

Page Break 68

characteristic--it presents, that is, a quite special appearance, the letters all roughly the same size, akin in shape too, and always recurring; most of the words constantly repeated and enormously familiar to us, like well-known faces.--Think of the uneasiness we feel when the spelling of a word is changed. (And of the still stronger feelings that questions about the spelling of words have aroused.) Of course, not all signs have impressed themselves on us so *strongly*. A sign in the algebra of logic for instance can be replaced by any other one without exciting a strong reaction in us.--

Page 68

Remember that the look of a word is familiar to us in the same kind of way as its sound.

Page 68

168. Again, our eye passes over printed lines differently from the way it passes over arbitrary pothooks and flourishes. (I am not speaking here of what can be established by observing the movement of the eyes of a reader.) The eye passes, one would like to say, with particular ease, without being held up; and yet it doesn't *skid*. And at the same time involuntary speech goes on in the imagination. That is how it is when I read German and other languages, printed or written, and in various styles.--But what in all this is essential to reading as such? Not any one feature that occurs in all cases of reading. (Compare reading ordinary print with reading words which are printed entirely in capital letters, as solutions of puzzles sometimes are. How different it is!--Or reading our script from right to left.)

Page 68

169. But when we read don't we feel the word-shapes somehow causing our utterance?--Read a sentence.--And now look along the following line

and say a sentence as you do so. Can't one feel that in the first case the utterance was *connected* with seeing the signs and in the second went on side by side with the seeing without any connexion?

Page 68

But why do you say that we felt a causal connexion? Causation is surely something established by experiments, by observing a regular concomitance of events for example. So how could I say that I *felt* something which is established by experiment? (It is indeed true that observation of regular concomitances is not the only way we establish causation.) One might rather say, I feel that the letters are the *reason* why I read such-and-such. For if someone asks me "Why

Page Break 69

do you read such-and-such?"--I justify my reading by the letters which are there.

Page 69

This justification, however, was something that I said, or thought: what does it mean to say that I *feel* it? I should like to say: when I read I feel a kind of *influence* of the letters working on me--but I feel no influence from that series of arbitrary flourishes on what I say.--Let us once more compare an individual letter with such a flourish. Should I also say I feel the influence of "i" when I read it? It does of course make a difference whether I say "i" when I see "i" or when I see "§". The difference is, for instance, that when I see the letter it is automatic for me to hear the sound "i" inwardly, it happens even against my will; and I pronounce the letter more effortlessly when I read it than when I am looking at "§". That is to say: this is how it is when I make the *experiment*; but of course it is not so if I happen to be looking at the mark "§" and at the same time pronounce a word in which the sound "i" occurs.

Page 69

170. It would never have occurred to us to think that we *felt the influence* of the letters on us when reading, if we had not compared the case of letters with that of arbitrary marks. And here we are indeed noticing a *difference*. And we interpret it as the difference between being influenced and not being influenced.

Page 69

In particular, this interpretation appeals to us especially when we make a point of reading slowly--perhaps in order to see what does happen when we read. When we, so to speak, quite intentionally let ourselves be *guided* by the letters. But this 'letting myself be guided' in turn only consists in my looking carefully at the letters--and perhaps excluding certain other thoughts.

Page 69

We imagine that a feeling enables us to perceive as it were a connecting mechanism between the look of the word and the sound that we utter. For when I speak of the experiences of being influenced, of causal connexion, of being guided, that is really meant to imply that I as it were feel the movement of the lever which connects seeing the letters with speaking.

Page 69

171. I might have used other words to hit off the experience I have when I read a word. Thus I might say that the written word *intimates* the sound to me.--Or again, that when one reads, letter and sound form a *unity*--as it were an alloy. (In the same way e.g. the faces of famous men and the sound of their names are fused together. This

Page Break 70

name strikes me as the only right one for this face.) When I feel this unity, I might say, I see or hear the sound in the written word.--

Page 70

But now just read a few sentences in print as you usually do when you are not thinking about the concept of reading; and ask yourself whether you had such experiences of unity, of being influenced and the rest, as you read.--Don't say you had them unconsciously! Nor should we be misled by the picture which suggests that these phenomena came in sight 'on closer inspection'. If I am supposed to describe how an object looks from far off, I don't make the description more accurate by saying what can be noticed about the object on closer inspection.

Page 70

172. Let us consider the experience of being guided, and ask ourselves: what does this experience consist in when for instance our *course* is guided?--Imagine the following cases:

Page 70

You are in a playing field with your eyes bandaged, and someone leads you by the hand, sometimes left, sometimes right; you have constantly to be ready for the tug of his hand, and must also take care not to stumble when he gives an unexpected tug.

Page 70

Or again: someone leads you by the hand where you are unwilling to go, by force.

Page 70

Or: you are guided by a partner in a dance; you make yourself as receptive as possible, in order to guess his intention and obey the slightest pressure.

Page 70

Or: someone takes you for a walk; you are having a conversation; you go wherever he does.

Page 70

Or: you walk along a field-track, simply following it.

Page 70

All these situations are similar to one another; but what is common to all the experiences?

Page 70

173. "But being guided is surely a particular experience!"--The answer to this is: you are now *thinking* of a particular experience of being guided.

Page 70

If I want to realize the experience of the person in one of the earlier examples, whose writing is guided by the printed text and the table, I imagine 'conscientious' looking-up, and so on. As I do this I assume a particular expression of face (say that of a conscientious bookkeeper). *Carefulness* is a most essential part of this picture; in another the exclusion of every volition of one's own would be essential. (But take something normal people do quite unconcernedly and imagine someone accompanying it with the expression--and why not the

Page Break 71

feelings?--of great carefulness.--Does that mean he is careful? Imagine a servant dropping the tea-tray and everything on it with all the outward signs of carefulness.) If I imagine such a particular experience, it seems to me to be *the* experience of being guided (or of reading). But now I ask myself: what are you doing?--You are looking at every letter, you are making this face, you are writing the letters with deliberation (and so on).--So that is the experience of being guided?--Here I should like to say: "No, it isn't that; it is something more inward, more essential."--It is as if at first all these more or less inessential processes were shrouded in a particular atmosphere, which dissipates when I look closely at them.

Page 71

174. Ask yourself how you draw a line parallel to a given one 'with deliberation'--and another time, with deliberation, one at an angle to it. What is the experience of deliberation? Here a particular look, a gesture, at once occur to you--and then you would like to say: "And it just is a *particular* inner experience". (And that is, of course, to add nothing).

Page 71

(This is connected with the problem of the nature of intention, of willing.)

Page 71

175. Make some arbitrary doodle on a bit of paper.--And now make a copy next to it, let yourself be guided by it.--I should like to say: "Sure enough, I was guided here. But as for what was characteristic in what happened--if I say what happened, I no longer find it characteristic."

Page 71

But now notice this: *while* I am being guided everything is quite simple, I notice nothing *special*; but afterwards, when I ask myself what it was that happened, it seems to have been something indescribable. *Afterwards* no description satisfies me. It's as if I couldn't believe that I merely looked, made such-and-such a face, and drew a line.--But don't I *remember* anything else? No; and yet I feel as if there must have been something else; in particular when I say "*guidance*", "*influence*", and other such words to myself. "For surely," I tell myself, "I was being *guided*."--Only then does the idea of that ethereal, intangible influence arise.

Page 71

176. When I look back on the experience I have the feeling that what is essential about it is an 'experience of being influenced', of a connexion--as opposed to any mere simultaneity of phenomena: but at the same time I should not be willing to call any experienced phenomenon the "experience of being influenced". (This contains the

Page Break 72

germ of the idea that the will is not a *phenomenon*.) I should like to say that I had experienced the '*because*', and yet I do not want to call any phenomenon the "experience of the because".

Page 72

177. I should like to say: "I experience the because". Not because I remember such an experience, but because when I reflect on what I experience in such a case I look at it through the medium of the concept 'because'

(or 'influence' or 'cause' or 'connexion').--For of course it is correct to say I drew the line under the influence of the original: this, however, does not consist simply in my feelings as I drew the line--under certain circumstances, it may consist in my drawing it parallel to the other--even though this in turn is not in general essential to being guided.--

Page 72

178. We also say: "You can *see* that I am guided by it"--and what do you see, if you see this?

Page 72

When I say to myself: "But I *am* guided"--I make perhaps a movement with my hand, which expresses guiding.--Make such a movement of the hand as if you were guiding someone along, and then ask yourself what the *guiding* character of this movement consisted in. For you were not guiding anyone. But you still want to call the movement one of 'guiding'. This movement and feeling did not contain the essence of guiding, but still this word forces itself upon you. It is just *a single form* of guiding which forces the expression on us.

Page 72

179. Let us return to our case (151). It is clear that we should not say B had the right to say the words "Now I know how to go on", just because he thought of the formula--unless experience shewed that there was a connexion between thinking of the formula--saying it, writing it down--and actually continuing the series. And obviously such a connexion does exist.--And now one might think that the sentence "I can go on" meant "I have an experience which I know empirically to lead to the continuation of the series." But does B mean that when he says he can go on? Does that sentence come to his mind, or is he ready to produce it in explanation of what he meant?

Page 72

No. The words "Now I know how to go on" were correctly used when he thought of the formula: that is, given such circumstances as that he had learnt algebra, had used such formulae before.--But that does not mean that his statement is only short for a description of all the circumstances which constitute the scene for our language-game.--Think how we learn to use the expressions "Now I know how to go

Page Break 73

on", "Now I can go on" and others; in what family of language-games we learn their use.

Page 73

We can also imagine the case where nothing at all occurred in B's mind except that he suddenly said "Now I know how to go on"--perhaps with a feeling of relief; and that he did in fact go on working out the series without using the formula. And in this case too we should say--in certain circumstances--that he did know how to go on.

Page 73

180. *This is how these words are used.* It would be quite misleading, in this last case, for instance, to call the words a "description of a mental state".--One might rather call them a "signal"; and we judge whether it was rightly employed by what he goes on to do.

Page 73

181. In order to understand this, we need also to consider the following: suppose B says he knows how to go on--but when he wants to go on he hesitates and can't do it: are we to say that he was wrong when he said he could go on, or rather that he was able to go on then, only now is not?--Clearly we shall say different things in different cases. (Consider both kinds of case.)

Page 73

182. The grammar of "to fit", "to be able", and "to understand". (Exercises: (1) When is a cylinder C said to fit into a hollow cylinder H? Only while C is stuck into H? (2) Sometimes we say that C ceased to fit into H at such-and-such a time. What criteria are used in such a case for its having happened at that time? (3) What does one regard as criteria for a body's having changed its weight at a particular time if it was not actually on the balance at that time? (4) Yesterday I knew the poem by heart; today I no longer know it. In what kind of case does it make sense to ask: "When did I stop knowing it?" (5) Someone asks me "Can you lift this weight?" I answer "Yes". Now he says "Do it!"--and I can't. In what kind of circumstances would it count as a justification to say "When I answered 'yes' I *could* do it, only now I can't"?)

Page 73

The criteria which we accept for 'fitting', 'being able to', 'understanding', are much more complicated than might appear at first sight. That is, the game with these words, their employment in the linguistic intercourse that is carried on by their means, is more involved--the role of these words in our language other--than we are tempted to think.

Page 73

(This role is what we need to understand in order to resolve philosophical paradoxes. And hence definitions usually fail to

resolve them; and so, *a fortiori* does the assertion that a word is 'indefinable'.)

183. But did "Now I can go on" in case (151) mean the same as "Now the formula has occurred to me" or something different? We may say that, in those circumstances, the two sentences have the same sense, achieve the same thing. But also that *in general* these two sentences do not have the same sense. We do say: "Now I can go on, I mean I know the formula", as we say "I can walk, I mean I have time"; but also "I can walk, I mean I am already strong enough"; or: "I can walk, as far as the state of my legs is concerned", that is, when we are contrasting *this* condition for walking with others. But here we must be on our guard against thinking that there is some *totality* of conditions corresponding to the nature of each case (e.g. for a person's walking) so that, as it were, he *could not but* walk if they were all fulfilled.

184. I want to remember a tune and it escapes me; suddenly I say "Now I know it" and I sing it. What was it like to suddenly know it? Surely it can't have occurred to me *in its entirety* in that moment!--Perhaps you will say: "It's a particular feeling, as if it were *there*"--but *is* it there? Suppose I now begin to sing it and get stuck?--But may I not have been *certain* at that moment that I knew it? So in some sense or other it was *there* after all!--But in what sense? You would say that the tune was there, if, say, someone sang it through, or heard it mentally from beginning to end. I am not, of course, denying that the statement that the tune is there can also be given a quite different meaning--for example, that I have a bit of paper on which it is written.--And what does his being 'certain', his knowing it, consist in?--Of course we can say: if someone says with conviction that now he knows the tune, then it is (somehow) present to his mind in its entirety at that moment--and this is a definition of the expression "the tune is present to his mind in its entirety".

185. Let us return to our example (143). Now--judged by the usual criteria--the pupil has mastered the series of natural numbers. Next we teach him to write down other series of cardinal numbers and get him to the point of writing down series of the form

0, n, 2n, 3n, etc.

at an order of the form "+ n"; so at the order "+ 1" he writes

down the series of natural numbers.--Let us suppose we have done exercises and given him tests up to 1000.

Now we get the pupil to continue a series (say + 2) beyond 1000--and he writes 1000, 1004, 1008, 1012.

We say to him: "Look what you've done!"--He doesn't understand. We say: "You were meant to add *two*: look how you began the series!"--He answers: "Yes, isn't it right? I thought that was how I was *meant* to do it."--Or suppose he pointed to the series and said: "But I went on in the same way."--It would now be no use to say: "But can't you see....?"--and repeat the old examples and explanations.--In such a case we might say, perhaps: It comes natural to this person to understand our order with our explanations as we should understand the order: "Add 2 up to 1000, 4 up to 2000, 6 up to 3000 and so on."

Such a case would present similarities with one in which a person naturally reacted to the gesture of pointing with the hand by looking in the direction of the line from finger-tip to wrist, not from wrist to finger-tip.

186. "What you are saying, then, comes to this: a new insight--intuition--is needed at every step to carry out the order '+ n' correctly."--To carry it out correctly! How is it decided what is the right step to take at any particular stage?--"The right step is the one that accords with the order--as it was *meant*."--So when you gave the order + 2 you meant that he was to write 1002 after 1000--and did you also mean that he should write 1868 after 1866, and 100036 after 100034, and so on--an infinite number of such propositions?--"No: what I meant was, that he should write the next but one number after *every* number that he wrote; and from this all those propositions follow in turn."--But that is just what is in question: what, at any stage, does follow from that sentence. Or, again, what, at any stage we are to call "being in accord" with that sentence (and with the *mean*-ing you then put into the sentence--whatever that may have consisted in). It would almost be more correct to say, not that an intuition was needed at every stage, but that a new decision was needed at every stage.

187. "But I already knew, at the time when I gave the order, that he ought to write 1002 after 1000."--Certainly; and you can also say you *meant* it then; only you should not let yourself be misled by the

grammar of the words "know" and "mean". For you don't want

Page Break 76

to say that you thought of the step from 1000 to 1002 at that time--and even if you did think of this step, still you did not think of other ones. When you said "I already knew at the time....." that meant something like: "If I had then been asked what number should be written after 1000, I should have replied '1002'." And that I don't doubt. This assumption is rather of the same kind as: "If he had fallen into the water then, I should have jumped in after him".--Now, what was wrong with your idea?

Page 76

188. Here I should first of all like to say: your idea was that that act of meaning the order had in its own way already traversed all those steps: that when you meant it your mind as it were flew ahead and took all the steps before you physically arrived at this or that one.

Page 76

Thus you were inclined to use such expressions as: "The steps are *really* already taken, even before I take them in writing or orally or in thought." And it seemed as if they were in some *unique* way predetermined, anticipated--as only the act of meaning can anticipate reality.

Page 76

189. "But *are* the steps then *not* determined by the algebraic formula?"--The question contains a mistake.

Page 76

We use the expression: "The steps are determined by the formula.....". *How* is it used?--We may perhaps refer to the fact that people are brought by their education (training) so to use the formula $y = x^2$, that they all work out the same value for y when they substitute the same number for x . Or we may say: "These people are so trained that they all take the same step at the same point when they receive the order 'add 3'". We might express this by saying: for these people the order "add 3" completely determines every step from one number to the next. (In contrast with other people who do not know what they are to do on receiving this order, or who react to it with perfect certainty, but each one in a different way.)

Page 76

On the other hand we can contrast different kinds of formula, and the different kinds of use (different kinds of training) appropriate to them. Then we *call* formulae of a particular kind (with the appropriate methods of use) "formulae which determine a number y for a given value of x ", and formulae of another kind, ones which "do not determine the number y for a given value of x ". ($y = x^2$ would be of the first kind, $y \neq x^2$ of the second.) The proposition "The formula.... determines a number y " will then be a statement about

Page Break 77

the form of the formula--and now we must distinguish such a proposition as "The formula which I have written down determines y ", or "Here is a formula which determines y ", from one of the following kind: "The formula $y = x^2$ determines the number y for a given value of x ". The question "Is the formula written down there one that determines y ?" will then mean the same as "Is what is there a formula of this kind or that?"--but it is not clear off-hand what we are to make of the question "Is $y = x^2$ a formula which determines y for a given value of x ?" One might address this question to a pupil in order to test whether he understands the use of the word "to determine"; or it might be a mathematical problem to prove in a particular system that x has only one square.

Page 77

190. It may now be said: "The way the formula is meant determines which steps are to be taken". What is the criterion for the way the formula is meant? It is, for example, the kind of way we always use it, the way we are taught to use it.

Page 77

We say, for instance, to someone who uses a sign unknown to us: "If by 'x!2' you mean x^2 , then you get *this* value for y , if you mean $2x$, *that* one."--Now ask yourself: how does one *mean* the one thing or the other by "x!2"?

Page 77

That will be how meaning it can determine the steps in advance.

Page 77

191. "It is as if we could grasp the whole use of the word in a flash." Like *what* e.g.?--Can't the use--in a certain sense--be grasped in a flash? And in *what* sense can it not?--The point is, that it is as if we could 'grasp it in a flash' in yet another and much more direct sense than that.--But have you a model for this? No. It is just that this expression suggests itself to us. As the result of the crossing of different pictures.

Page 77

192. You have no model of this superlative fact, but you are seduced into using a super-expression. (It might

be called a philosophical superlative.)

Page 77

193. The machine as symbolizing its action: the action of a machine--I might say at first--seems to be there in it from the start. What does that mean?--If we know the machine, everything else, that is its movement, seems to be already completely determined.

Page 77

We talk as if these parts could only move in this way, as if they could not do anything else. How is this--do we forget the possibility of their bending, breaking off, melting, and so on? Yes; in many cases

Page Break 78

we don't think of that at all. We use a machine, or the drawing of a machine, to symbolize a particular action of the machine. For instance, we give someone such a drawing and assume that he will derive the movement of the parts from it. (Just as we can give someone a number by telling him that it is the twenty-fifth in the series 1, 4, 9, 16,)

Page 78

"The machine's action seems to be in it from the start" means: we are inclined to compare the future movements of the machine in their definiteness to objects which are already lying in a drawer and which we then take out.--But we do not say this kind of thing when we are concerned with predicting the actual behaviour of a machine. Then we do not in general forget the possibility of a distortion of the parts and so on.--We *do* talk like that, however, when we are wondering at the way we can use a machine to symbolize a given way of moving--since it can also move in quite *different* ways.

Page 78

We might say that a machine, or the picture of it, is the first of a series of pictures which we have learnt to derive from this one.

Page 78

But when we reflect that the machine could also have moved differently it may look as if the way it moves must be contained in the machine-as-symbol far more determinately than in the actual machine. As if it were not enough for the movements in question to be empirically determined in advance, but they had to be really--in a mysterious sense--already *present*. And it is quite true: the movement of the machine-as-symbol is predetermined in a different sense from that in which the movement of any given actual machine is predetermined.

Page 78

194. When does one have the thought: the possible movements of a machine are already there in it in some mysterious way?--Well, when one is doing philosophy. And what leads us into thinking that? The kind of way in which we talk about machines. We say, for example, that a machine *has* (possesses) such-and-such possibilities of movement; we speak of the ideally rigid machine which *can* only move in such-and-such a way.--What is this *possibility* of movement? It is not the *movement*, but it does not seem to be the mere physical conditions for moving either--as, that there is play between socket and pin, the pin not fitting too tight in the socket. For while this is the empirical condition for movement, one could also imagine it to be otherwise. The possibility of a movement is, rather, supposed to be like a shadow of the movement itself. But do you know of such a shadow? And by a shadow I do not mean some picture of the movement--for such a

Page Break 79

picture would not have to be a picture of just *this* movement. But the possibility of this movement must be the possibility of just this movement. (See how high the seas of language run here!)

Page 79

The waves subside as soon as we ask ourselves: how do we use the phrase "possibility of movement" when we are talking about a given machine?--But then where did our queer ideas come from? Well, I shew you the possibility of a movement, say by means of a *picture* of the movement: 'so possibility is something which is like reality'. We say: "It isn't moving yet, but it already has the possibility of moving"--'so possibility is something very near reality'. Though we may doubt whether such-and-such physical conditions make this movement possible, we never discuss whether *this* is the possibility of this or of that movement: 'so the possibility of the movement stands in a unique relation to the movement itself; closer than that of a picture to its subject'; for it can be doubted whether a picture is the picture of this thing or that. We say "Experience will shew whether this gives the pin this possibility of movement", but we do not say "Experience will shew whether this is the possibility of this movement": 'so it is not an empirical fact that this possibility is the possibility of precisely this movement'.

Page 79

We mind about the kind of expressions we use concerning these things; we do not understand them, however, but misinterpret them. When we do philosophy we are like savages, primitive people, who hear the

expressions of civilized men, put a false interpretation on them, and then draw the queerest conclusions from it.

Page 79

195. "But I don't mean that what I do now (in grasping a sense) determines the future use *causally* and as a matter of experience, but that in a *queer* way, the use itself is in some sense present."--But of course it is, 'in *some* sense'! Really the only thing wrong with what you say is the expression "in a queer way". The rest is all right; and the sentence only seems queer when one imagines a different language-game for it from the one in which we actually use it. (Someone once told me that as a child he had been surprised that a tailor could 'sew a dress'--he thought this meant that a dress was produced by sewing alone, by sewing one thread on to another.)

Page 79

196. In our failure to understand the use of a word we take it as the expression of a queer *process*. (As we think of time as a queer medium, of the mind as a queer kind of being.)

Page Break 80

Page 80

197. "It's as if we could grasp the whole use of a word in a flash."--And that is just what we say we do. That is to say: we sometimes describe what we do in these words. But there is nothing astonishing, nothing queer, about what happens. It becomes queer when we are led to think that the future development must in some way already be present in the act of grasping the use and yet isn't present.--For we say that there isn't any doubt that we understand the word, and on the other hand its meaning lies in its use. There is no doubt that I now want to play chess, but chess is the game it is in virtue of all its rules (and so on). Don't I know, then, which game I want to play until I *have* played it? or are all the rules contained in my act of intending? Is it experience that tells me that this sort of game is the usual consequence of such an act of intending? so is it impossible for me to be certain what I am intending to do? And if that is nonsense--what kind of super-strong connexion exists between the act of intending and the thing intended?--Where is the connexion effected between the sense of the expression "Let's play a game of chess" and all the rules of the game?--Well, in the list of rules of the game, in the teaching of it, in the day-to-day practice of playing.

Page 80

198. "But how can a rule shew me what I have to do at *this* point? Whatever I do is, on some interpretation, in accord with the rule."--That is not what we ought to say, but rather: any interpretation still hangs in the air along with what it interprets, and cannot give it any support. Interpretations by themselves do not determine meaning.

Page 80

"Then can whatever I do be brought into accord with the rule?"--Let me ask this: what has the expression of a rule--say a sign-post--got to do with my actions? What sort of connexion is there here?--Well, perhaps this one: I have been trained to react to this sign in a particular way, and now I do so react to it.

Page 80

But that is only to give a causal connexion; to tell how it has come about that we now go by the sign-post; not what this going-by-the-sign really consists in. On the contrary; I have further indicated that a person goes by a sign-post only in so far as there exists a regular use of sign-posts, a custom.

Page 80

199. Is what we call "obeying a rule" something that it would be possible for only *one* man to do, and to do only *once* in his life?--This is of course a note on the grammar of the expression "to obey a rule".

Page Break 81

Page 81

It is not possible that there should have been only one occasion on which someone obeyed a rule. It is not possible that there should have been only one occasion on which a report was made, an order given or understood; and so on.--To obey a rule, to make a report, to give an order, to play a game of chess, are *customs* (uses, institutions).

Page 81

To understand a sentence means to understand a language. To understand a language means to be master of a technique.

Page 81

200. It is, of course, imaginable that two people belonging to a tribe unacquainted with games should sit at a chess-board and go through the moves of a game of chess; and even with all the appropriate mental accompaniments. And if we were to see it we should say they were playing chess. But now imagine a game of chess translated according to certain rules into a series of actions which we do not ordinarily associate with a *game*--say into yells and stamping of feet. And now suppose those two people to yell and stamp instead of playing the form of

chess that we are used to; and this in such a way that their procedure is translatable by suitable rules into a game of chess. Should we still be inclined to say they were playing a game? What right would one have to say so?

Page 81

201. This was our paradox: no course of action could be determined by a rule, because every course of action can be made out to accord with the rule. The answer was: if everything can be made out to accord with the rule, then it can also be made out to conflict with it. And so there would be neither accord nor conflict here.

Page 81

It can be seen that there is a misunderstanding here from the mere fact that in the course of our argument we give one interpretation after another; as if each one contented us at least for a moment, until we thought of yet another standing behind it. What this shews is that there is a way of grasping a rule which is *not* an *interpretation*, but which is exhibited in what we call "obeying the rule" and "going against it" in actual cases.

Page 81

Hence there is an inclination to say: every action according to the rule is an interpretation. But we ought to restrict the term "interpretation" to the substitution of one expression of the rule for another.

Page 81

202. And hence also 'obeying a rule' is a practice. And to *think* one is obeying a rule is not to obey a rule. Hence it is not possible to obey a rule 'privately': otherwise thinking one was obeying a rule would be the same thing as obeying it.

Page Break 82

Page 82

203. Language is a labyrinth of paths. You approach from *one* side and know your way about; you approach the same place from another side and no longer know your way about.

Page 82

204. As things are I can, for example, invent a game that is never played by anyone.--But would the following be possible too: mankind has never played any games; once, however, someone invented a game--which no one ever played?

Page 82

205. "But it is just the queer thing about *intention*, about the mental process, that the existence of a custom, of a technique, is not necessary to it. That, for example, it is imaginable that two people should play chess in a world in which otherwise no games existed; and even that they should begin a game of chess--and then be interrupted."

Page 82

But isn't chess defined by its rules? And how are these rules present in the mind of the person who is intending to play chess?

Page 82

206. Following a rule is analogous to obeying an order. We are trained to do so; we react to an order in a particular way. But what if one person reacts in one way and another in another to the order and the training? Which one is right?

Page 82

Suppose you came as an explorer into an unknown country with a language quite strange to you. In what circumstances would you say that the people there gave orders, understood them, obeyed them, rebelled against them, and so on?

Page 82

The common behaviour of mankind is the system of reference by means of which we interpret an unknown language.

Page 82

207. Let us imagine that the people in that country carried on the usual human activities and in the course of them employed, apparently, an articulate language. If we watch their behaviour we find it intelligible, it seems 'logical'. But when we try to learn their language we find it impossible to do so. For there is no regular connexion between what they say, the sounds they make, and their actions; but still these sounds are not superfluous, for if we gag one of the people, it has the same consequences as with us; without the sounds their actions fall into confusion--as I feel like putting it.

Page 82

Are we to say that these people have a language: orders, reports, and the rest?

Page 82

There is not enough regularity for us to call it "language".

Page 82

208. Then am I defining "order" and "rule" by means of "regularity"?--How do I explain the meaning of "regular", "uniform",

Page Break 83

"same" to anyone?--I shall explain these words to someone who, say, only speaks French by means of the corresponding French words. But if a person has not yet got the *concepts*, I shall teach him to use the words by means of *examples* and by *practice*.--And when I do this I do not communicate less to him than I know myself.

Page 83

In the course of this teaching I shall shew him the same colours, the same lengths, the same shapes, I shall make him find them and produce them, and so on. I shall, for instance, get him to continue an ornamental pattern uniformly when told to do so.--And also to continue progressions. And so, for example, when given: to go on:

Page 83

I do it, he does it after me; and I influence him by expressions of agreement, rejection, expectation, encouragement. I let him go his way, or hold him back; and so on.

Page 83

Imagine witnessing such teaching. None of the words would be explained by means of itself; there would be no logical circle.

Page 83

The expressions "and so on", "and so on ad infinitum" are also explained in this teaching. A gesture, among other things, might serve this purpose. The gesture that means "go on like this", or "and so on" has a function comparable to that of pointing to an object or a place.

Page 83

We should distinguish between the "and so on" which is, and the "and so on" which is not, an abbreviated notation. "And so on ad inf." is *not* such an abbreviation. The fact that we cannot write down all the digits of π is not a human shortcoming, as mathematicians sometimes think.

Page 83

Teaching which is not meant to apply to anything but the examples given is different from that which '*points beyond*' them.

Page 83

209. "But then doesn't our understanding reach beyond all the examples?"--A very queer expression, and a quite natural one!--

Page 83

But is that *all*? Isn't there a deeper explanation; or mustn't at least the *understanding* of the explanation be deeper?--Well, have I myself a deeper understanding? Have I *got* more than I give in the explanation?--But then, whence the feeling that I have got more?

Page 83

Is it like the case where I interpret what is not limited as a length that reaches beyond every length?

Page 83

210. "But do you really explain to the other person what you yourself understand? Don't you get him to *guess* the essential thing? You give him examples,--but he has to guess their drift, to guess your

Page Break 84

intention."--Every explanation which I can give myself I give to him too.--"He guesses what I intend" would mean: various interpretations of my explanation come to his mind, and he lights on one of them. So in this case he could ask; and I could and should answer him.

Page 84

211. How can he *know* how he is to continue a pattern by himself--whatever instruction you give him?--Well, how do I know?--If that means "Have I reasons?" the answer is: my reasons will soon give out. And then I shall act, without reasons.

Page 84

212. When someone whom I am afraid of orders me to continue the series, I act quickly, with perfect certainty, and the lack of reasons does not trouble me.

Page 84

213. "But this initial segment of a series obviously admitted of various interpretations (e.g. by means of algebraic expressions) and so you must first have chosen *one* such interpretation."--Not at all. A doubt was possible in certain circumstances. But that is not to say that I did doubt, or even could doubt. (There is something to be said,

which is connected with this, about the psychological 'atmosphere' of a process.)

Page 84

So it must have been intuition that removed this doubt?--If intuition is an inner voice--how do I know *how* I am to obey it? And how do I know that it doesn't mislead me? For if it can guide me right, it can also guide me wrong.

Page 84

((Intuition an unnecessary shuffle.))

Page 84

214. If you have to have an intuition in order to develop the series 1 2 3 4... you must also have one in order to develop the series 2 2 2 2....

Page 84

215. But isn't *the same* at least the same?

Page 84

We seem to have an infallible paradigm of identity in the identity of a thing with itself. I feel like saying: "Here at any rate there can't be a variety of interpretations. If you are seeing a thing you are seeing identity too."

Page 84

Then are two things the same when they are what *one* thing is? And how am I to apply what the *one* thing shows me to the case of two things?

Page 84

216. "A thing is identical with itself."--There is no finer example of a useless proposition, which yet is connected with a certain play of the imagination. It is as if in imagination we put a thing into its own shape and saw that it fitted.

Page Break 85

Page 85

We might also say: "Every thing fits into itself." Or again: "Every thing fits into its own shape." At the same time we look at a thing and imagine that there was a blank left for it, and that now it fits into it exactly.

Page 85

Does this spot  'fit' into its white surrounding?--*But that is just how it would look* if there had at first been a hole in its place and it then fitted into the hole. But when we say "it fits" we are not simply describing this appearance; not simply this *situation*.

Page 85

"Every coloured patch fits exactly into its surrounding" is a rather specialized form of the law of identity.

Page 85

217. "How am I able to obey a rule?"--if this is not a question about causes, then it is about the justification for my following the rule in the way I do.

Page 85

If I have exhausted the justifications I have reached bedrock, and my spade is turned. Then I am inclined to say: "This is simply what I do."

Page 85

(Remember that we sometimes demand definitions for the sake not of their content, but of their form. Our requirement is an architectural one; the definition a kind of ornamental coping that supports nothing.)

Page 85

218. Whence comes the idea that the beginning of a series is a visible section of rails invisibly laid to infinity? Well, we might imagine rails instead of a rule. And infinitely long rails correspond to the unlimited application of a rule.

Page 85

219. "All the steps are really already taken" means: I no longer have any choice. The rule, once stamped with a particular meaning, traces the lines along which it is to be followed through the whole of space.--But if something of this sort really were the case, how would it help?

Page 85

No; my description only made sense if it was to be understood symbolically.--I should have said: *This is how it strikes me*.

Page 85

When I obey a rule, I do not choose.

Page 85

I obey the rule *blindly*.

220. But what is the purpose of that symbolical proposition? It was supposed to bring into prominence a difference between being causally determined and being logically determined.

221. My symbolical expression was really a mythological description of the use of a rule.

222. "The line intimates to me the way I am to go."--But that is of course only a picture. And if I judged that it intimated this or that as it were irresponsibly, I should not say that I was obeying it like a rule.

223. One does not feel that one has always got to wait upon the nod (the whisper) of the rule. On the contrary, we are not on tenterhooks about what it will tell us next, but it always tells us the same, and we do what it tells us.

One might say to the person one was training: "Look, I always do the same thing: I...."

224. The word "agreement" and the word "rule" are *related* to one another, they are cousins. If I teach anyone the use of the one word, he learns the use of the other with it.

225. The use of the word "rule" and the use of the word "same" are interwoven. (As are the use of "proposition" and the use of "true".)

226. Suppose someone gets the series of numbers 1, 3, 5, 7,.... by working out the series $2x + 1 \nmid 1$. And now he asks himself: "But am I always doing the same thing, or something different every time?"

If from one day to the next you promise: "To-morrow I will come and see you"--are you saying the same thing every day, or every day something different?

227. Would it make sense to say "If he did something *different* every day we should not say he was obeying a rule"? That makes *no* sense.

228. "We see a series in just *one* way!"--All right, but what is that way? Clearly we see it algebraically, and as a segment of an expansion. Or is there more in it than that?--"But the way we see it surely gives us everything!"--But that is not an observation about the segment of the series; or about anything that we notice in it; it gives expression to the fact that we look to the rule for instruction and *do something*, without appealing to anything else for guidance.

229. I believe that I perceive something drawn very fine in a segment of a series, a characteristic design, which only needs the addition of "and so on", in order to reach to infinity.

230. "The line intimates to me which way I am to go" is only a paraphrase of: it is my *last* arbiter for the way I am to go.

231. "But surely you can see....?" That is just the characteristic expression of someone who is under the compulsion of a rule.

232. Let us imagine a rule intimating to me which way I am to obey it; that is, as my eye travels along the line, a voice within me says: "*This* way!"--What is the difference between this process of obeying a kind of inspiration and that of obeying a rule? For they are surely not the same. In the case of inspiration I *await* direction. I shall not be able to teach anyone else my 'technique' of following the line. Unless, indeed, I teach him some way of hearkening, some kind of receptivity. But then, of course, I cannot require him to follow the line in the same way as I do.

These are not my experiences of acting from inspiration and according to a rule; they are grammatical notes.

233. It would also be possible to imagine such a training in a sort of arithmetic. Children could calculate, each in his own way--as long as they listened to their inner voice and obeyed it. Calculating in this way would be like a sort of composing.

234. Would it not be possible for us, however, to calculate as we actually do (all agreeing, and so on), and still at every step to have a feeling of being guided by the rules as by a spell, feeling astonishment at the fact that we agreed? (We might give thanks to the Deity for our agreement.)

235. This merely shews what goes to make up what we call "obeying a rule" in everyday life.

236. Calculating prodigies who get the right answer but cannot say how. Are we to say that they do not calculate? (A family of cases.)

237. Imagine someone using a line as a rule in the following way: he holds a pair of compasses, and carries one of its points along the line that is the 'rule', while the other one draws the line that follows the rule. And while he moves along the ruling line he alters the opening of the compasses, apparently with great precision, looking at the rule the whole time as if it determined what he did. And watching him we see no kind of regularity in this opening and shutting of the compasses. We cannot learn his way of following the line from it. Here perhaps one really would say: "The original seems to *intimate* to him which way he is to go. But it is not a rule."

238. The rule can only seem to me to produce all its consequences in advance if I draw them as a *matter of course*. As much as it is a matter

of course for me to call this colour "blue". (Criteria for the fact that something is 'a matter of course' for me.)

239. How is he to know what colour he is to pick out when he hears "red"?--Quite simple: he is to take the colour whose image occurs to him when he hears the word.--But how is he to know which colour it is 'whose image occurs to him'? Is a further criterion needed for that? (There is indeed such a procedure as choosing the colour which occurs to one when one hears the word "....")

"Red' means the colour that occurs to me when I hear the word 'red'"--would be a *definition*. Not an explanation of *what it is* to use a word as a name.

240. Disputes do not break out (among mathematicians, say) over the question whether a rule has been obeyed or not. People don't come to blows over it, for example. That is part of the framework on which the working of our language is based (for example, in giving descriptions).

241. "So you are saying that human agreement decides what is true and what is false?"--It is what human beings say that is true and false; and they agree in the *language* they use. That is not agreement in opinions but in form of life.

242. If language is to be a means of communication there must be agreement not only in definitions but also (queer as this may sound) in judgments. This seems to abolish logic, but does not do so.--It is one thing to describe methods of measurement, and another to obtain and state results of measurement. But what we call "measuring" is partly determined by a certain constancy in results of measurement.

243. A human being can encourage himself, give himself orders, obey, blame and punish himself; he can ask himself a question and answer it. We could even imagine human beings who spoke only in monologue; who accompanied their activities by talking to themselves.--An explorer who watched them and listened to their talk might succeed in translating their language into ours. (This would enable him to predict these people's actions correctly, for he also hears them making resolutions and decisions.)

But could we also imagine a language in which a person could write down or give vocal expression to his inner experiences--his feelings, moods, and the rest--for his private use?--Well, can't we do so in our ordinary language?--But that is not what I mean. The

individual words of this language are to refer to what can only be known to the person speaking; to his immediate private sensations. So another person cannot understand the language.

244. How do words *refer* to sensations?--There doesn't seem to be any problem here; don't we talk about sensations every day, and give them names? But how is the connexion between the name and the thing named set up? This question is the same as: how does a human being learn the meaning of the names of sensations?--of the word "pain" for example. Here is one possibility: words are connected with the primitive, the natural, expressions of the sensation and used in their place. A child has hurt himself and he cries; and then adults talk to him and teach him exclamations and, later, sentences. They teach the child new pain-behaviour.

"So you are saying that the word 'pain' really means crying?"--On the contrary: the verbal expression of pain replaces crying and does not describe it.

245. For how can I go so far as to try to use language to get between pain and its expression?

246. In what sense are my sensations *private*?--Well, only I can know whether I am really in pain; another person can only surmise it.--In one way this is wrong, and in another nonsense. If we are using the word "to know" as it is normally used (and how else are we to use it?), then other people very often know when I am in pain.--Yes, but all the same not with the certainty with which I know it myself!--It can't be said of me at all (except perhaps as a joke) that I *know* I am in pain. What is it supposed to mean--except perhaps that I *am* in pain?

Other people cannot be said to learn of my sensations *only* from my behaviour,--for *I* cannot be said to learn of them. I *have* them.

The truth is: it makes sense to say about other people that they doubt whether I am in pain; but not to say it about myself.

247. "Only you can know if you had that intention." One might tell someone this when one was explaining the meaning of the word "intention" to him. For then it means: *that* is how we use it.

(And here "know" means that the expression of uncertainty is senseless.)

248. The proposition "Sensations are private" is comparable to: "One plays patience by oneself".

249. Are we perhaps over-hasty in our assumption that the smile of an unweaned infant is not a pretence?--And on what experience is our assumption based?

(Lying is a language-game that needs to be learned like any other one.)

250. Why can't a dog simulate pain? Is he too honest? Could one teach a dog to simulate pain? Perhaps it is possible to teach him to howl on particular occasions as if he were in pain, even when he is not. But the surroundings which are necessary for this behaviour to be real simulation are missing.

251. What does it mean when we say: "I can't imagine the opposite of this" or "What would it be like, if it were otherwise?"--For example, when someone has said that my images are private, or that only I myself can know whether I am feeling pain, and similar things.

Of course, here "I can't imagine the opposite" doesn't mean: my powers of imagination are unequal to the task. These words are a defence against something whose form makes it look like an empirical proposition, but which is really a grammatical one.

But why do we say: "I can't imagine the opposite"? Why not: "I can't imagine the thing itself"?

Example: "Every rod has a length." That means something like: we call something (or *this*) "the length of a rod"--but nothing "the length of a sphere." Now can I imagine 'every rod having a length'? Well, I simply imagine a rod. Only this picture, in connexion with this proposition, has a quite different role from one used in connexion with the proposition "This table has the same length as the one over there". For here I understand what it means to have a picture of the opposite (nor need it be a mental picture).

Page 90

But the picture attaching to the grammatical proposition could only shew, say, what is called "the length of a rod". And what should the opposite picture be?

Page 90

((Remark about the negation of an a priori proposition.))

Page 90

252. "This body has extension." To this we might reply: "Nonsense!"--but are inclined to reply "Of course!"--Why is this?

Page Break 91

Page 91

253. "Another person can't have my pains."--Which are *my* pains? What counts as a criterion of identity here? Consider what makes it possible in the case of physical objects to speak of "two exactly the same", for example, to say "This chair is not the one you saw here yesterday, but is exactly the same as it".

Page 91

In so far as it makes *sense* to say that my pain is the same as his, it is also possible for us both to have the same pain. (And it would also be imaginable for two people to feel pain in the same--not just the corresponding--place. That might be the case with Siamese twins, for instance.)

Page 91

I have seen a person in a discussion on this subject strike himself on the breast and say: "But surely another person can't have THIS pain!"--The answer to this is that one does not define a criterion of identity by emphatic stressing of the word "this". Rather, what the emphasis does is to suggest the case in which we are conversant with such a criterion of identity, but have to be reminded of it.

Page 91

254. The substitution of "identical" for "the same" (for instance) is another typical expedient in philosophy. As if we were talking about shades of meaning and all that were in question were to find words to hit on the correct nuance. That is in question in philosophy only where we have to give a psychologically exact account of the temptation to use a particular kind of expression. What we 'are tempted to say' in such a case is, of course, not philosophy; but it is its raw material. Thus, for example, what a mathematician is inclined to say about the objectivity and reality of mathematical facts, is not a philosophy of mathematics, but something for philosophical *treatment*.

Page 91

255. The philosopher's treatment of a question is like the treatment of an illness.

Page 91

256. Now, what about the language which describes my inner experiences and which only I myself can understand? *How* do I use words to stand for my sensations?--As we ordinarily do? Then are my words for sensations tied up with my natural expressions of sensation? In that case my language is not a 'private' one. Someone else might understand it as well as I.--But suppose I didn't have any natural expression for the sensation, but only had the sensation? And now I simply *associate* names with sensations and use these names in descriptions.--

Page Break 92

Page 92

257. "What would it be like if human beings shewed no outward signs of pain (did not groan, grimace, etc.)? Then it would be impossible to teach a child the use of the word 'tooth-ache'."--Well, let's assume the child is a genius and itself invents a name for the sensation!--But then, of course, he couldn't make himself understood when he used the word.--So does he understand the name, without being able to explain its meaning to anyone?--But what does it mean to say that he has 'named his pain'?--How has he done this naming of pain?! And whatever he did, what was its purpose?--When one says "He gave a name to his sensation" one forgets that a great deal of stage-setting in the language is presupposed if the mere act of naming is to make sense. And when we speak of someone's having given a name to pain, what is presupposed is the existence of the grammar of the word "pain"; it shews the post where the new word is stationed.

258. Let us imagine the following case. I want to keep a diary about the recurrence of a certain sensation. To this end I associate it with the sign "S" and write this sign in a calendar for every day on which I have the sensation.--I will remark first of all that a definition of the sign cannot be formulated.--But still I can give myself a kind of ostensive definition.--How? Can I point to the sensation? Not in the ordinary sense. But I speak, or write the sign down, and at the same time I concentrate my attention on the sensation--and so, as it were, point to it inwardly.--But what is this ceremony for? for that is all it seems to be! A definition surely serves to establish the meaning of a sign.--Well, that is done precisely by the concentrating of my attention; for in this way I impress on myself the connexion between the sign and the sensation.--But "I impress it on myself" can only mean: this process brings it about that I remember the connexion *right* in the future. But in the present case I have no criterion of correctness. One would like to say: whatever is going to seem right to me is right. And that only means that here we can't talk about 'right'.

259. Are the rules of the private language *impressions* of rules?--The balance on which impressions are weighed is not the *impression* of a balance.

260. "Well, I *believe* that this is the sensation S again."--Perhaps you *believe* that you believe it!

Then did the man who made the entry in the calendar make a note

of *nothing whatever*?--Don't consider it a matter of course that a person is making a note of something when he makes a mark--say in a calendar. For a note has a function, and this "S" so far has none.

(One can talk to oneself.--If a person speaks when no one else is present, does that mean he is speaking to himself?)

261. What reason have we for calling "S" the sign for a *sensation*? For "sensation" is a word of our common language, not of one intelligible to me alone. So the use of this word stands in need of a justification which everybody understands.--And it would not help either to say that it need not be a *sensation*; that when he writes "S", he has *something*--and that is all that can be said. "Has" and "something" also belong to our common language.--So in the end when one is doing philosophy one gets to the point where one would like just to emit an inarticulate sound.--But such a sound is an expression only as it occurs in a particular language-game, which should now be described.

262. It might be said: if you have given yourself a private definition of a word, then you must inwardly *undertake* to use the word in such-and-such a way. And how do you undertake that? Is it to be assumed that you invent the technique of using the word; or that you found it ready-made?

263. "But I can (inwardly) undertake to call THIS 'pain' in the future."--"But is it certain that you have undertaken it? Are you sure that it was enough for this purpose to concentrate your attention on your feeling?"--A queer question.--

264. "Once you know *what* the word stands for, you understand it, you know its whole use."

265. Let us imagine a table (something like a dictionary) that exists only in our imagination. A dictionary can be used to justify the translation of a word X by a word Y. But are we also to call it a justification if such a table is to be looked up only in the imagination?--"Well, yes; then it is a subjective justification."--But justification consists in appealing to something independent.--"But surely I can appeal from one memory to another. For example, I don't know if I have remembered the time of departure of a train right and to check it I call to mind how a page of the time-table looked. Isn't it the same here?"--No; for this process has got to produce a memory which is

actually *correct*. If the mental image of the time-table could not itself be *tested* for correctness, how could it confirm the correctness of the first memory? (As if someone were to buy several copies of the morning paper to assure himself that what it said was true.)

Looking up a table in the imagination is no more looking up a table than the image of the result of an imagined experiment is the result of an experiment.

Page 94

266. I can look at the clock to see what time it is: but I can also look at the dial of a clock in order to *guess* what time it is; or for the same purpose move the hand of a clock till its position strikes me as right. So the look of a clock may serve to determine the time in more than one way. (Looking at the clock in imagination.)

Page 94

267. Suppose I wanted to justify the choice of dimensions for a bridge which I imagine to be building, by making loading tests on the material of the bridge in my imagination. This would, of course, be to imagine what is called justifying the choice of dimensions for a bridge. But should we also call it justifying an imagined choice of dimensions?

Page 94

268. Why can't my right hand give my left hand money?--My right hand can put it into my left hand. My right hand can write a deed of gift and my left hand a receipt.--But the further practical consequences would not be those of a gift. When the left hand has taken the money from the right, etc., we shall ask: "Well, and what of it?" And the same could be asked if a person had given himself a private definition of a word; I mean, if he has said the word to himself and at the same time has directed his attention to a sensation.

Page 94

269. Let us remember that there are certain criteria in a man's behaviour for the fact that he does not understand a word: that it means nothing to him, that he can do nothing with it. And criteria for his 'thinking he understands', attaching some meaning to the word, but not the right one. And, lastly, criteria for his understanding the word right. In the second case one might speak of a subjective understanding. And sounds which no one else understands but which I '*appear to understand*' might be called a "private language".

Page 94

270. Let us now imagine a use for the entry of the sign "S" in my diary. I discover that whenever I have a particular sensation a manometer

Page Break 95

shews that my blood-pressure rises. So I shall be able to say that my blood-pressure is rising without using any apparatus. This is a useful result. And now it seems quite indifferent whether I have recognized the sensation *right* or not. Let us suppose I regularly identify it wrong, it does not matter in the least. And that alone shews that the hypothesis that I make a mistake is mere show. (We as it were turned a knob which looked as if it could be used to turn on some part of the machine; but it was a mere ornament, not connected with the mechanism at all.)

Page 95

And what is our reason for calling "S" the name of a sensation here? Perhaps the kind of way this sign is employed in this language-game.--And why a "particular sensation," that is, the same one every time? Well, aren't we supposing that we write "S" every time?

Page 95

271. "Imagine a person whose memory could not retain what the word 'pain' meant--so that he constantly called different things by that name--but nevertheless used the word in a way fitting in with the usual symptoms and presuppositions of pain"--in short he uses it as we all do. Here I should like to say: a wheel that can be turned though nothing else moves with it, is not part of the mechanism.

Page 95

272. The essential thing about private experience is really not that each person possesses his own exemplar, but that nobody knows whether other people also have *this* or something else. The assumption would thus be possible--though unverifiable--that one section of mankind had one sensation of red and another section another.

Page 95

273. What am I to say about the word "red"?--that it means something 'confronting us all' and that everyone should really have another word, besides this one, to mean his *own* sensation of red? Or is it like this: the word "red" means something known to everyone; and in addition, for each person, it means something known only to him? (Or perhaps rather: it *refers* to something known only to him.)

Page 95

274. Of course, saying that the word "red" "refers to" instead of "means" something private does not help us in the least to grasp its function; but it is the more psychologically apt expression for a particular experience in doing philosophy. It is as if when I uttered the word I cast a sidelong glance at the private sensation, as it were in order to say to myself: I know all right what I mean by it.

275. Look at the blue of the sky and say to yourself "How blue the sky is!"--When you do it spontaneously--without philosophical intentions--the idea never crosses your mind that this impression of colour belongs only to *you*. And you have no hesitation in exclaiming that to someone else. And if you point at anything as you say the words you point at the sky. I am saying: you have not the feeling of pointing-into-yourself, which often accompanies 'naming the sensation' when one is thinking about 'private language'. Nor do you think that really you ought not to point to the colour with your hand, but with your attention. (Consider what it means "to point to something with the attention".)

276. But don't we at least *mean* something quite definite when we look at a colour and name our colour-impression? It is as if we detached the colour-*impression* from the object, like a membrane. (This ought to arouse our suspicions.)

277. But how is even possible for us to be tempted to think that we use a word to *mean* at one time the colour known to everyone--and at another the 'visual impression' which *I* am getting *now*? How can there be so much as a temptation here?--I don't turn the same kind of attention on the colour in the two cases. When I mean the colour impression that (as I should like to say) belongs to me alone I immerse myself in the colour--rather like when I 'cannot get my fill of a colour'. Hence it is easier to produce this experience when one is looking at a bright colour, or at an impressive colour-scheme.

278. "I know how the colour green looks to *me*"--surely that makes sense!--Certainly: what use of the proposition are you thinking of?

279. Imagine someone saying: "But I know how tall I am!" and laying his hand on top of his head to prove it.

280. Someone paints a picture in order to shew how he imagines a theatre scene. And now I say: "This picture has a double function: it informs others, as pictures or words inform--but for the one who gives the information it is a representation (or piece of information?) of another kind: for him it is the picture of his image, as it can't be for anyone else. To him his private impression of the picture means what he has imagined, in a sense in which the picture cannot mean this to others."--And what right have I to speak in this second

case of a representation or piece of information--if these words were rightly used in the *first* case?

281. "But doesn't what you say come to this: that there is no pain, for example, without *pain-behaviour*?"--It comes to this: only of a living human being and what resembles (behaves like) a living human being can one say: it has sensations; it sees; is blind; hears; is deaf; is conscious or unconscious.

282. "But in a fairy tale the pot too can see and hear!" (Certainly; but it *can* also talk.)

"But the fairy tale only invents what is not the case: it does not talk *nonsense*."--It is not as simple as that. Is it false or nonsensical to say that a pot talks? Have we a clear picture of the circumstances in which we should say of a pot that it talked? (Even a nonsense-poem is not nonsense in the same way as the babbling of a child.)

We do indeed say of an inanimate thing that it is in pain: when playing with dolls for example. But this use of the concept of pain is a secondary one. Imagine a case in which people ascribed pain *only* to inanimate things; pitied *only* dolls! (When children play at trains their game is connected with their knowledge of trains. It would nevertheless be possible for the children of a tribe unacquainted with trains to learn this game from others, and to play it without knowing that it was copied from anything. One might say that the game did not make the same *sense* to them as to us.)

283. What gives us *so much as the idea* that living beings, things, can feel?

Is it that my education has led me to it by drawing my attention to feelings in myself, and now I transfer the idea to objects outside myself? That I recognize that there is something there (in me) which I can call "pain" without getting into conflict with the way other people use this word?--I do not transfer my idea to stones, plants, etc.

Couldn't I imagine having frightful pains and turning to stone while they lasted? Well, how do I know, if I shut my eyes, whether I have not turned into a stone? And if that has happened, in what sense will *the stone* have the pains? In what sense will they be ascribable to the stone? And why need the pain have a bearer at all here?!

And can one say of the stone that it has a soul and *that* is what has the pain? What has a soul, or pain, to do with a stone?

Only of what behaves like a human being can one say that it *has* pains.

For one has to say it of a body, or, if you like of a soul which some body *has*. And how can a body *have* a soul?

284. Look at a stone and imagine it having sensations.--One says to oneself: How could one so much as get the idea of ascribing a *sensation* to a *thing*? One might as well ascribe it to a number!--And now look at a wriggling fly and at once these difficulties vanish and pain seems able to get a foothold here, where before everything was, so to speak, too smooth for it.

And so, too, a corpse seems to us quite inaccessible to pain.--Our attitude to what is alive and to what is dead, is not the same. All our reactions are different.--If anyone says: "That cannot simply come from the fact that a living thing moves about in such-and-such a way and a dead one not", then I want to intimate to him that this is a case of the transition 'from quantity to quality'.

285. Think of the recognition of *facial expressions*. Or of the description of facial expressions--which does not consist in giving the measurements of the face! Think, too, how one can imitate a man's face without seeing one's own in a mirror.

286. But isn't it absurd to say of a *body* that it has pain?--And why does one feel an absurdity in that? In what sense is it true that my hand does not feel pain, but I in my hand?

What sort of issue is: Is it the *body* that feels pain?--How is it to be decided? What makes it plausible to say that it is *not* the body?--Well, something like this: if someone has a pain in his hand, then the hand does not say so (unless it writes it) and one does not comfort the hand, but the sufferer: one looks into his face.

287. How am I filled with pity *for this man*? How does it come out what the object of my pity is? (Pity, one may say, is a form of conviction that someone else is in pain.)

288. I turn to stone and my pain goes on.--Suppose I were in error and it was no longer *pain*?--But I can't be in error here; it means nothing to doubt whether I am in pain!--That means: if anyone said "I do not know if what I have got is a pain or something else", we should think something like, he does not know what the

English word "pain" means; and we should explain it to him.--How? Perhaps by means of gestures, or by pricking him with a pin and saying: "See, that's what pain is!" This explanation, like any other, he might understand right, wrong, or not at all. And he will shew which he does by his use of the word, in this as in other cases.

If he now said, for example: "Oh, I know what 'pain' means; what I don't know is whether *this*, that I have now, is pain"--we should merely shake our heads and be forced to regard his words as a queer reaction which we have no idea what to do with. (It would be rather as if we heard someone say seriously: "I distinctly remember that some time before I was born I believed.....".)

That expression of doubt has no place in the language-game; but if we cut out human behaviour, which is the expression of sensation, it looks as if I might *legitimately* begin to doubt afresh. My temptation to say that one might take a sensation for something other than what it is arises from this: if I assume the abrogation of the normal language-game with the expression of a sensation, I need a criterion of identity for the sensation; and then the

possibility of error also exists.

Page 99

289. "When I say 'I am in pain' I am at any rate justified *before myself*."--What does that mean? Does it mean: "If someone else could know what I am calling 'pain', he would admit that I was using the word correctly"?

Page 99

To use a word without a justification does not mean to use it without right.

Page 99

290. What I do is not, of course, to identify my sensation by criteria: but to repeat an expression. But this is not the *end* of the language-game: it is the beginning.

Page 99

But isn't the beginning the sensation--which I describe?--Perhaps this word "describe" tricks us here. I say "I describe my state of mind" and "I describe my room". You need to call to mind the differences between the language-games.

Page 99

291. What we call "*descriptions*" are instruments for particular uses. Think of a machine-drawing, a cross-section, an elevation with measurements, which an engineer has before him. Thinking of a description as a word-picture of the facts has something misleading about it: one tends to think only of such pictures as hang on our walls: which seem simply to portray how a thing looks, what it is like. (These pictures are as it were idle.)

Page Break 100

Page 100

292. Don't always think that you read off what you say from the facts; that you portray these in words according to rules. For even so you would have to apply the rule in the particular case without guidance.

Page 100

293. If I say of myself that it is only from my own case that I know what the word "pain" means--must I not say the same of other people too? And how can I generalize the *one* case so irresponsibly?

Page 100

Now someone tells me that *he* knows what pain is only from his own case!--Suppose everyone had a box with something in it: we call it a "beetle". No one can look into anyone else's box, and everyone says he knows what a beetle is only by looking at *his* beetle.--Here it would be quite possible for everyone to have something different in his box. One might even imagine such a thing constantly changing.--But suppose the word "beetle" had a use in these people's language?--If so it would not be used as the name of a thing. The thing in the box has no place in the language-game at all; not even as a *something*: for the box might even be empty.--No, one can 'divide through' by the thing in the box; it cancels out, whatever it is.

Page 100

That is to say: if we construe the grammar of the expression of sensation on the model of 'object and designation' the object drops out of consideration as irrelevant.

Page 100

294. If you say he sees a private picture before him, which he is describing, you have still made an assumption about what he has before him. And that means that you can describe it or do describe it more closely. If you admit that you haven't any notion what kind of thing it might be that he has before him--then what leads you into saying, in spite of that, that he has something before him? Isn't it as if I were to say of someone: "He *has* something. But I don't know whether it is money, or debts, or an empty till."

Page 100

295. "I know.... only from my *own* case"--what kind of proposition is this meant to be at all? An experiential one? No.--A grammatical one?

Page 100

Suppose everyone does say about himself that he knows what pain is only from his own pain.--Not that people really say that, or are even prepared to say it. But *if* everybody said it--it might be a kind of exclamation. And even if it gives no information, still it is a picture, and why should we not want to call up such a picture? Imagine an allegricoal [[sic]] painting taking the place of those words.

Page 100

When we look into ourselves as we do philosophy, we often get to

Page Break 101

see just such a picture. A full-blown pictorial representation of our grammar. Not facts; but as it were illustrated turns of speech.

296. "Yes, but there is *something* there all the same accompanying my cry of pain. And it is on account of that that I utter it. And this something is what is important--and frightful."--Only whom are we informing of this? And on what occasion?

297. Of course, if water boils in a pot, steam comes out of the pot and also pictured steam comes out of the pictured pot. But what if one insisted on saying that there must also be something boiling in the picture of the pot?

298. The very fact that we should so much like to say: "*This* is the important thing"--while we point privately to the sensation--is enough to shew how much we are inclined to say something which gives no information.

299. Being unable--when we surrender ourselves to philosophical thought--to help saying such-and-such; being irresistibly inclined to say it--does not mean being forced into an *assumption*, or having an immediate perception or knowledge of a state of affairs.

300. It is--we should like to say--not merely the picture of the behaviour that plays a part in the language-game with the words "he is in pain", but also the picture of the pain. Or, not merely the paradigm of the behaviour, but also that of the pain.--It is a misunderstanding to say "The picture of pain enters into the language-game with the word 'pain'." The image of pain is not a picture and *this* image is not replaceable in the language-game by anything that we should call a picture.--The image of pain certainly enters into the language game in a sense; only not as a picture.

301. An image is not a picture, but a picture can correspond to it.

302. If one has to imagine someone else's pain on the model of one's own, this is none too easy a thing to do: for I have to imagine pain which I *do not feel* on the model of the pain which I *do feel*. That is, what I have to do is not simply to make a transition in imagination from one place of pain to another. As, from pain in the hand to pain in the arm. For I am not to imagine that I feel pain in some region of his body. (Which would also be possible.)

Pain-behaviour can point to a painful place--but the subject of pain is the person who gives it expression.

303. "I can only *believe* that someone else is in pain, but I *know* it if I am."--Yes: one can make the decision to say "I believe he is in pain" instead of "He is in pain". But that is all.--What looks like an explanation here, or like a statement about a mental process, is in truth an exchange of one expression for another which, while we are doing philosophy, seems the more appropriate one.

Just try--in a real case--to doubt someone else's fear or pain.

304. "But you will surely admit that there is a difference between pain-behaviour accompanied by pain and pain-behaviour without any pain?"--Admit it? What greater difference could there be?"--And yet you again and again reach the conclusion that the sensation itself is a *nothing*."--Not at all. It is not a *something*, but not a *nothing* either! The conclusion was only that a nothing would serve just as well as a something about which nothing could be said. We have only rejected the grammar which tries to force itself on us here.

The paradox disappears only if we make a radical break with the idea that language always functions in one way, always serves the same purpose: to convey thoughts--which may be about houses, pains, good and evil, or anything else you please.

305. "But you surely cannot deny that, for example, in remembering, an inner process takes place."--What gives the impression that we want to deny anything? When one says "Still, an inner process does take place here"--one wants to go on: "After all, you *see* it." And it is this inner process that one means by the word "remembering".--The impression that we wanted to deny something arises from our setting our faces against the picture of the 'inner process'. What we deny is that the picture of the inner process gives us the correct idea of the use of the word "to remember". We say that this picture with its ramifications stands in the way of our seeing the use of the word as it is.

306. Why should I deny that there is a mental process? But "There has just taken place in me the mental process of remembering...." means nothing more than: "I have just remembered....". To deny the mental process would mean to deny the remembering; to deny that anyone ever remembers anything.

307. "Are you not really a behaviourist in disguise? Aren't you at bottom really saying that everything except human behaviour is

a fiction?"--If I do speak of a fiction, then it is of a *grammatical* fiction.

308. How does the philosophical problem about mental processes and states and about behaviourism arise?--The first step is the one that altogether escapes notice. We talk of processes and states and leave their nature undecided. Sometime perhaps we shall know more about them--we think. But that is just what commits us to a particular way of looking at the matter. For we have a definite concept of what it means to learn to know a process better. (The decisive movement in the conjuring trick has been made, and it was the very one that we thought quite innocent.)--And now the analogy which was to make us understand our thoughts falls to pieces. So we have to deny the yet uncomprehended process in the yet unexplored medium. And now it looks as if we had denied mental processes. And naturally we don't want to deny them.

309. What is your aim in philosophy?--To shew the fly the way out of the fly-bottle.

310. I tell someone I am in pain. His attitude to me will then be that of belief; disbelief; suspicion; and so on.

Let us assume he says: "It's not so bad."--Doesn't that prove that he believes in something behind the outward expression of pain?--His attitude is a proof of his attitude. Imagine not merely the words "I am in pain" but also the answer "It's not so bad" replaced by instinctive noises and gestures.

311. "What difference could be greater?"--In the case of pain I believe that I can give myself a private exhibition of the difference. But I can give anyone an exhibition of the difference between a broken and an unbroken tooth.--But for the private exhibition you don't have to give yourself actual pain; it is enough to *imagine* it--for instance, you screw up your face a bit. And do you know that what you are giving yourself this exhibition of is pain and not, for example, a facial expression? And how do you know what you are to give yourself an exhibition of before you do it? This *private* exhibition is an illusion.

312. But again, *aren't* the cases of the tooth and the pain similar? For the visual sensation in the one corresponds to the sensation of pain in the other. I can exhibit the visual sensation to myself as little or as well as the sensation of pain.

Let us imagine the following: The surfaces of the things around us (stones, plants, etc.) have patches and regions which produce pain in our skin when we touch them. (Perhaps through the chemical composition of these surfaces. But we need not know that.) In this case we should speak of pain-patches on the leaf of a particular plant just as at present we speak of red patches. I am supposing that it is useful to us to notice these patches and their shapes; that we can infer important properties of the objects from them.

313. I can exhibit pain, as I exhibit red, and as I exhibit straight and crooked and trees and stones.--*That* is what we *call* "exhibiting".

314. It shews a fundamental misunderstanding, if I am inclined to study the headache I have now in order to get clear about the philosophical problem of sensation.

315. Could someone understand the word "pain", who had *never* felt pain?--Is experience to teach me whether this is so or not?--And if we say "A man could not imagine pain without having sometime felt it"--how do we know? How can it be decided whether it is true?

316. In order to get clear about the meaning of the word "think" we watch ourselves while we think; what we observe will be what the word means!--But this concept is not used like that. (It would be as if without knowing how to play chess, I were to try and make out what the word "mate" meant by close observation of the last move of some game of chess.)

Page 104

317. Misleading parallel: the expression of pain is a cry--the expression of thought, a proposition.

Page 104

As if the purpose of the proposition were to convey to one person how it is with another: only, so to speak, in his thinking part and not in his stomach.

Page 104

318. Suppose we think while we talk or write--I mean, as we normally do--we shall not in general say that we think quicker than we talk; the thought seems *not to be separate* from the expression. On the other hand, however, one does speak of the speed of thought; of how a thought goes through one's head like lightning; how problems become clear to us in a flash, and so on. So it is natural to ask if the same thing happens in lightning-like thought--only extremely accelerated--as when we talk and 'think while we talk.' So that in the

Page Break 105

first case the clockwork runs down all at once, but in the second bit by bit, braked by the words.

Page 105

319. I can see or understand a whole thought in a flash in exactly the sense in which I can make a note of it in a few words or a few pencilled dashes.

Page 105

What makes this note into an epitome of this thought?

Page 105

320. The lightning-like thought may be connected with the spoken thought as the algebraic formula is with the sequence of numbers which I work out from it.

Page 105

When, for example, I am given an algebraic function, I am CERTAIN that I shall be able to work out its values for the arguments 1, 2, 3,... up to 10. This certainty will be called 'well-founded', for I have learned to compute such functions, and so on. In other cases no reasons will be given for it--but it will be justified by success.

Page 105

321. "What happens when a man suddenly understands?"--The question is badly framed. If it is a question about the meaning of the expression "sudden understanding", the answer is not to point to a process that we give this name to.--The question might mean: what are the tokens of sudden understanding; what are its characteristic psychical accompaniments?

Page 105

(There is no ground for assuming that a man feels the facial movements that go with his expression, for example, or the alterations in his breathing that are characteristic of some emotion. Even if he feels them as soon as his attention is directed towards them.) ((Posture.))

Page 105

322. The question what the expression means is not answered by such a description; and this misleads us into concluding that understanding is a specific indefinable experience. But we forget that what should interest us is the question: how do we *compare* these experiences; what criterion of identity *do we fix* for their occurrence?

Page 105

323. "Now I know how to go on!" is an exclamation; it corresponds to an instinctive sound, a glad start. Of course it does not follow from my feeling that I shall not find I am stuck when I do try to go on.--Here there are cases in which I should say: "When I said I knew how to go on, I *did* know." One will say that if, for example, an unforeseen interruption occurs. But what is unforeseen must not simply be that I get stuck.

Page Break 106

Page 106

We could also imagine a case in which light was always seeming to dawn on someone--he exclaims "Now I have it!" and then can never justify himself in practice.--It might seem to him as if in the twinkling of an eye he forgot again the meaning of the picture that occurred to him.

Page 106

324. Would it be correct to say that it is a matter of induction, and that I am as certain that I shall be able to continue the series, as I am that this book will drop on the ground when I let it go; and that I should be no less

astonished if I suddenly and for no obvious reason got stuck in working out the series, than I should be if the book remained hanging in the air instead of falling?--To that I will reply that we don't need any grounds for *this* certainty either. What could justify the certainty *better* than success?

Page 106

325. "The certainty that I shall be able to go on after I have had this experience--seen the formula, for instance,--is simply based on induction." What does this mean?--"The certainty that the fire will burn me is based on induction." Does that mean that I argue to myself: "Fire has always burned me, so it will happen now too?" Or is the previous experience the *cause* of my certainty, not its ground? Whether the earlier experience is the cause of the certainty depends on the system of hypotheses, of natural laws, in which we are considering the phenomenon of certainty.

Page 106

Is our confidence justified?--What people accept as a justification--is shewn by how they think and live.

Page 106

326. We expect *this*, and are surprised at *that*. But the chain of reasons has an end.

Page 106

327. "Can one think without speaking?"--And what is *thinking*?--Well, don't you ever think? Can't you observe yourself and see what is going on? It should be quite simple. You do not have to wait for it as for an astronomical event and then perhaps make your observation in a hurry.

Page 106

328. Well, what does one include in 'thinking'? What has one learnt to use this word for?--If I say I have thought--need I always be right?--What *kind* of mistake is there room for here? Are there circumstances in which one would ask: "Was what I was doing then really thinking; am I not making a mistake?" Suppose someone takes a measurement in the middle of a train of thought: has he interrupted the thought if he says nothing to himself during the measuring?

Page Break 107

Page 107

329. When I think in language, there aren't 'meanings' going through my mind in addition to the verbal expressions: the language is itself the vehicle of thought.

Page 107

330. Is thinking a kind of speaking? One would like to say it is what distinguishes speech with thought from talking without thinking.--And so it seems to be an accompaniment of speech. A process, which may accompany something else, or can go on by itself.

Page 107

Say: "Yes, this pen is blunt. Oh well, it'll do." First, thinking it; then without thought; then just think the thought without the words.--Well, while doing some writing I might test the point of my pen, make a face--and then go on with a gesture of resignation.--I might also act in such a way while taking various measurements that an onlooker would say I had--without words--thought: If two magnitudes are equal to a third, they are equal to one another.--But what constitutes thought here is not some process which has to accompany the words if they are not to be spoken without thought.

Page 107

331. Imagine people who could only think aloud. (As there are people who can only read aloud.)

Page 107

332. While we sometimes call it "thinking" to accompany a sentence by a mental process, that accompaniment is not what we mean by a "thought".--Say a sentence and think it; say it with understanding.--And now do not say it, and just do what you accompanied it with when you said it with understanding!--(Sing this tune with expression. And now don't sing it, but repeat its expression!--And here one actually might repeat something. For example, motions of the body, slower and faster breathing, and so on.)

Page 107

333. "Only someone who is *convinced* can say that."--How does the conviction help him when he says it?--Is it somewhere at hand by the side of the spoken expression? (Or is it masked by it, as a soft sound by a loud one, so that it can, as it were, no longer be heard when one expresses it out loud?) What if someone were to say "In order to be able to sing a tune from memory one has to hear it in one's mind and sing from that"?

Page 107

334. "So you really wanted to say...."--We use this phrase in order to lead someone from one form of expression to another. One is tempted to use the following picture: what he really 'wanted to say', what he 'meant' was already *present somewhere* in his mind even

before we gave it expression. Various kinds of thing may persuade us to give up one expression and to adopt another in its place. To understand this, it is useful to consider the relation in which the solutions of mathematical problems stand to the context and ground of their formulation. The concept 'trisection of the angle with ruler and compass', when people are trying to do it, and, on the other hand, when it has been proved that there is no such thing.

Page 108

335. What happens when we make an effort--say in writing a letter--to find the right expression for our thoughts?--This phrase compares the process to one of translating or describing: the thoughts are already there (perhaps were there in advance) and we merely look for their expression. This picture is more or less appropriate in different cases.--But can't all sorts of things happen here?--I surrender to a mood and the expression *comes*. Or a picture occurs to me and I try to describe it. Or an English expression occurs to me and I try to hit on the corresponding German one. Or I make a gesture, and ask myself: What words correspond to this gesture? And so on.

Page 108

Now if it were asked: "Do you have the thought before finding the expression?" what would one have to reply? And what, to the question: "What did the thought consist in, as it existed before its expression?"

Page 108

336. This case is similar to the one in which someone imagines that one could not think a sentence with the remarkable word order of German or Latin just as it stands. One first has to think it, and then one arranges the words in that queer order. (A French politician once wrote that it was a peculiarity of the French language that in its words occur in the order in which one thinks them.)

Page 108

337. But didn't I already intend the whole construction of the sentence (for example) at its beginning? So surely it already existed in my mind before I said it out loud!--If it was in my mind, still it would not normally be there in some different word order. But here we are constructing a misleading picture of 'intending', that is, of the use of this word. An intention is embedded in its situation, in human customs and institutions. If the technique of the game of chess did not exist, I could not intend to play a game of chess. In so far as I do intend the construction of a sentence in advance, that is made possible by the fact that I can speak the language in question.

Page 109

338. After all, one can only say something if one has learned to talk. Therefore in order to *want* to say something one must also have mastered a language; and yet it is clear that one can want to speak without speaking. Just as one can want to dance without dancing.

Page 109

And when we think about this, we grasp at the *image* of dancing, speaking, etc..

Page 109

339. Thinking is not an incorporeal process which lends life and sense to speaking, and which it would be possible to detach from speaking, rather as the Devil took the shadow of Schlemiehl from the ground.--But how "not an incorporeal process"? Am I acquainted with incorporeal processes, then, only thinking is not one of them? No; I called the expression "an incorporeal process" to my aid in my embarrassment when I was trying to explain the meaning of the word "thinking" in a primitive way.

Page 109

One might say "Thinking is an incorporeal process", however, if one were using this to distinguish the grammar of the word "think" from that of, say, the word "eat". Only that makes the difference between the meanings look *too slight*. (It is like saying: numerals are actual, and numbers non-actual, objects.) An unsuitable type of expression is a sure means of remaining in a state of confusion. It as it were bars the way out.

Page 109

340. One cannot guess how a word functions. One has to *look at* its use and learn from that.

Page 109

But the difficulty is to remove the prejudice which stands in the way of doing this. It is not a *stupid* prejudice.

Page 109

341. Speech with and without thought is to be compared with the playing of a piece of music with and without thought.

342. William James, in order to shew that thought is possible without speech, quotes the recollection of a deaf-mute, Mr. Ballard, who wrote that in his early youth, even before he could speak, he had had thoughts about God and the world.--What can he have meant?--Ballard writes: "It was during those delightful rides, some two or three years before my initiation into the rudiments of written language, that I began to ask myself the question: how came the world into being?"--Are you sure--one would like to ask--that this is the correct translation of your wordless thought into words? And why does this question--which otherwise seems not to exist--raise its head here? Do I want to say that the writer's memory deceives

him?--I don't even know if I should say *that*. These recollections are a queer memory phenomenon,--and I do not know what conclusions one can draw from them about the past of the man who recounts them.

343. The words with which I express my memory are my memory-reaction.

344. Would it be imaginable that people should never speak an audible language, but should still say things to themselves in the imagination?

"If people always said things only to themselves, then they would merely be doing *always* what as it is they do *sometimes*."--So it is quite easy to imagine this: one need only make the easy transition from some to all. (Like: "An infinitely long row of trees is simply one that does *not* come to an end.") Our criterion for someone's saying something to himself is what he tells us and the rest of his behaviour; and we only say that someone speaks to himself if, in the ordinary sense of the words, he *can speak*. And we do not say it of a parrot; nor of a gramophone.

345. "What sometimes happens might always happen."--What kind of proposition is that? It is like the following: If " $F(a)$ " makes sense " $(x).F(x)$ " makes sense.

"If it is possible for someone to make a false move in some game, then it might be possible for everybody to make nothing but false moves in every game."--Thus we are under a temptation to misunderstand the logic of our expressions here, to give an incorrect account of the use of our words.

Orders are sometimes not obeyed. But what would it be like if no orders were *ever* obeyed? The concept 'order' would have lost its purpose.

346. But couldn't we imagine God's suddenly giving a parrot understanding, and its now saying things to itself?--But here it is an important fact that I imagined a deity in order to imagine this.

347. "But at least I know from my own case what it means 'to say things to oneself'. And if I were deprived of the organs of speech, I could still talk to myself."

If I know it only from my own case, then I know only what *I* call that, not what anyone else does.

348. "These deaf-mutes have learned only a gesture-language, but each of them talks to himself inwardly in a vocal language."--Now,

don't you understand that?--But how do I know whether I understand it?!--What can I do with this information (if it is such)? The whole idea of understanding smells fishy here. I do not know whether I am to say I understand it or don't understand it. I might answer "It's an English sentence; *apparently* quite in order--that is, until one wants to do something with it; it has a connexion with other sentences which makes it difficult for us to say that nobody really knows what it tells us; but everyone who has not become calloused by doing philosophy notices that there is something wrong here."

349. "But this supposition surely makes good sense!"--Yes; in ordinary circumstances these words and this picture have an application with which we are familiar.--But if we suppose a case in which this application falls away we become as it were conscious for the first time of the nakedness of the words and the picture.

350. "But if I suppose that someone has a pain, then I am simply supposing that he has just the same as I have so often had."--That gets us no further. It is as if I were to say: "You surely know what 'It is 5 o'clock here' means; so you also know what 'It's 5 o'clock on the sun' means. It means simply that it is just the same time there as it is here when it is 5 o'clock."--The explanation by means of *identity* does not work here. For I know well enough that one can call 5 o'clock here and 5 o'clock there "the same time", but what I do not know is in what cases one is to speak of its being the same time here and there.

Page 111

In exactly the same way it is no explanation to say: the supposition that he has a pain is simply the supposition that he has the same as I. For *that* part of the grammar is quite clear to me: that is, that one will say that the stove has the same experience as I, *if* one says: it is in pain and I am in pain.

Page 111

351. Yet we go on wanting to say: "Pain is pain--whether *he* has it, or *I* have it; and however I come to know whether he has a pain or not."--I might agree.--And when you ask me "Don't you know, then, what I mean when I say that the stove is in pain?"--I can reply: These words may lead me to have all sorts of images; but their usefulness goes no further. And I can also imagine something in connexion with the words: "It was just 5 o'clock in the afternoon on the sun"--such as a grandfather clock which points to 5.--But a still better example would be that of the application of "above" and "below" to the earth. Here we all have a quite clear idea of what

Page Break 112

"above" and "below" mean. I see well enough that I am on top; the earth is surely beneath me! (And don't smile at this example. We are indeed all taught at school that it is stupid to talk like that. But it is much easier to bury a problem than to solve it.) And it is only reflection that shews us that in this case "above" and "below" cannot be used in the ordinary way. (That we might, for instance, say that the people at the antipodes are 'below' our part of the earth, but it must also be recognized as right for them to use the same expression about us.)

Page 112

352. Here it happens that our thinking plays us a queer trick. We want, that is, to quote the law of excluded middle and to say: "Either such an image is in his mind, or it is not; there is no third possibility!"--We encounter this queer argument also in other regions of philosophy. "In the decimal expansion of π either the group "7777" occurs, or it does not--there is no third possibility." That is to say: "God sees--but we don't know." But what does that mean?--We use a picture; the picture of a visible series which one person sees the whole of and another not. The law of excluded middle says here: It must either look like this, or like that. So it really--and this is a truism--says nothing at all, but gives us a picture. And the problem ought now to be: does reality accord with the picture or not? And this picture *seems* to determine what we have to do, what to look for, and how--but it does not do so, just because we do not know how it is to be applied. Here saying "There is no third possibility" or "But there can't be a third possibility!"--expresses our inability to turn our eyes away from this picture: a picture which looks as if it must already contain both the problem and its solution, while all the time we *feel* that it is not so.

Page 112

Similarly when it is said "Either he has this experience, or not"--what primarily occurs to us is a picture which by itself seems to make the sense of the expressions *unmistakable*: "Now you know what is in question"--we should like to say. And that is precisely what it does not tell him.

Page 112

353. Asking whether and how a proposition can be verified is only a particular way of asking "How d'you mean?" The answer is a contribution to the grammar of the proposition.

Page 112

354. The fluctuation in grammar between criteria and symptoms makes it look as if there were nothing at all but symptoms. We say,

Page Break 113

for example: "Experience teaches that there is rain when the barometer falls, but it also teaches that there is rain when we have certain sensations of wet and cold, or such-and-such visual impressions." In defence of this one says that these sense-impressions can deceive us. But here one fails to reflect that the fact that the false appearance is precisely one of rain is founded on a definition.

Page 113

355. The point here is not that our sense-impressions can lie, but that we understand their language. (And this language like any other is founded on convention.)

Page 113

356. One is inclined to say: "Either it is raining, or it isn't--how I know, how the information has reached me,

is another matter." But then let us put the question like this: What do I call "information that it is raining"? (Or have I only information of this information too?) And what gives this 'information' the character of information about something? Doesn't the form of our expression mislead us here? For isn't it a misleading metaphor to say: "My eyes give me the information that there is a chair over there"?

Page 113

357. We do not say that *possibly* a dog talks to itself. Is that because we are so minutely acquainted with its soul? Well, one might say this: If one sees the behaviour of a living thing, one sees its soul.--But do I also say in my own case that I am saying something to myself, because I am behaving in such-and-such a way?--I do *not* say it from observation of my behaviour. But it only makes sense because I do behave in this way.--Then it is not because I *mean* it that it makes sense?

Page 113

358. But isn't it our *meaning* it that gives sense to the sentence? (And here, of course, belongs the fact that one cannot mean a senseless series of words.) And 'meaning it' is something in the sphere of the mind. But it is also something private! It is the intangible *something*; only comparable to consciousness itself.

Page 113

How could this seem ludicrous? It is, as it were, a dream of our language.

Page 113

359. Could a machine think?--Could it be in pain?--Well, is the human body to be called such a machine? It surely comes as close as possible to being such a machine.

Page 113

360. But a machine surely cannot think!--Is that an empirical statement? No. We only say of a human being and what is like one that it thinks. We also say it of dolls and no doubt of spirits too. Look at the word "to think" as a tool.

Page Break 114

Page 114

361. The chair is thinking to itself:.....

Page 114

WHERE? In one of its parts? Or outside its body; in the air around it? Or not *anywhere* at all? But then what is the difference between this chair's saying something to itself and another one's doing so, next to it?--But then how is it with man: where does *he* say things to himself? How does it come about that this question seems senseless; and that no specification of a place is necessary except just that this man is saying something to himself? Whereas the question *where* the chair talks to itself seems to demand an answer.--The reason is: we want to know *how* the chair is supposed to be like a human being; whether, for instance, the head is at the top of the back and so on.

Page 114

What is it like to say something to oneself; what happens here?--How am I to explain it? Well, only as you might teach someone the meaning of the expression "to say something to oneself". And certainly we learn the meaning of that as children.--Only no one is going to say that the person who teaches it to us tells us 'what takes place'.

Page 114

362. Rather it seems to us as though in this case the instructor *imparted* the meaning to the pupil--without telling him it directly; but in the end the pupil is brought to the point of giving himself the correct ostensive definition. And this is where our illusion is.

Page 114

363. "But when I imagine something, something certainly *happens!*" Well, something happens--and then I make a noise. What for? Presumably in order to tell what happens.--But how is *telling* done? When are we said to *tell* anything?--What is the language-game of telling?

Page 114

I should like to say: you regard it much too much as a matter of course that one can tell anything to anyone. That is to say: we are so much accustomed to communication through language, in conversation, that it looks to us as if the whole point of communication lay in this: someone else grasps the sense of my words--which is something mental: he as it were takes it into his own mind. If he then does something further with it as well, that is no part of the immediate purpose of language.

Page 114

One would like to say "Telling brings it about that he *knows* that I am in pain; it produces this mental phenomenon; everything else is inessential to the telling." As for what this queer phenomenon of knowledge is--there is time enough for that. Mental processes just are queer. (It is as if one said: "The clock tells us the time.

What time is, is not yet settled. And as for what one tells the time *for*--that doesn't come in here.")

Page Break 115

Page 115

364. Someone does a sum in his head. He uses the result, let's say, for building a bridge or a machine.--Are you trying to say that he has not *really* arrived at this number by calculation? That it has, say, just 'come' to him in the manner of a kind of dream? There surely must have been calculation going on, and there was. For he *knows* that, and how, he calculated; and the correct result he got would be inexplicable without calculation.--But what if I said: "*It strikes him as if* he had calculated. And why should the correct result be explicable? Is it not incomprehensible enough, that without saying a word, without making a note, he was able to CALCULATE?"--

Page 115

Is calculating in the imagination in some sense less real than calculating on paper? It is real--calculation-in-the-head.--Is it like calculation on paper?--I don't know whether to call it like. Is a bit of white paper with black lines on it like a human body?

Page 115

365. Do Adelheid and the Bishop play a *real* game of chess?--Of course. They are not merely pretending--which would also be possible as part of a play.--But, for example, the game has no beginning!--Of course it has; otherwise it would not be a game of chess.--

Page 115

366. Is a sum in the head less real than a sum on paper?--Perhaps one is inclined to say some such thing; but one can get oneself to think the opposite as well by telling oneself: paper, ink, etc. are only logical constructions out of our sense-data.

Page 115

"I have done the multiplication..... in my head"--do I perhaps not *believe* such a statement?--But was it really a multiplication? It was not merely 'a' multiplication, but *this* one--in the head. This is the point at which I go wrong. For I now want to say: it was some mental process *corresponding* to the multiplication on paper. So it would make sense to say: "*This* process in the mind corresponds to *this* process on paper." And it would then make sense to talk of a method of projection according to which the image of the sign was a representation of the sign itself.

Page 115

367. The mental picture is the picture which is described when someone describes what he imagines.

Page 115

368. I describe a room to someone, and then get him to paint an *impressionistic* picture from this description to shew that he has understood it.--Now he paints the chairs which I described as green, dark red; where I said "yellow", he paints blue.--That is the impression

Page Break 116

which he got of that room. And now I say: "Quite right! That's what it's like."

Page 116

369. One would like to ask: "What is it like--what happens--when one does a sum in one's head?"--And in a particular case the answer may be "First I add 17 and 18, then I subtract 39.....". But that is not the answer to our question. What is called doing sums in one's head is not explained by *such* an answer.

Page 116

370. One ought to ask, not what images are or what happens when one imagines anything, but how the word "imagination" is used. But that does not mean that I want to talk only about words. For the question as to the nature of the imagination is as much about the word "imagination" as my question is. And I am only saying that this question is not to be decided--neither for the person who does the imagining, nor for anyone else--by pointing; nor yet by a description of any process. The first question also asks for a word to be explained; but it makes us expect a wrong kind of answer.

Page 116

371. *Essence* is expressed by grammar.

Page 116

372. Consider: "The only correlate in language to an intrinsic necessity is an arbitrary rule. It is the only thing which one can milk out of this intrinsic necessity into a proposition."

Page 116

373. Grammar tells what kind of object anything is. (Theology as grammar.)

Page 116

374. The great difficulty here is not to represent the matter as if there were something one *couldn't* do. As if

there really were an object, from which I derive its description, but I were unable to shew it to anyone.--And the best that I can propose is that we should yield to the temptation to use this picture, but then investigate how the *application* of the picture goes.

Page 116

375. How does one teach anyone to read to himself? How does one know if he can do so? How does he himself know that he is doing what is required of him?

Page 116

376. When I say the ABC to myself, what is the criterion of my doing the same as someone else who silently repeats it to himself? It might be found that the same thing took place in my larynx and in his. (And similarly when we both think of the same thing, wish the same, and so on.) But then did we learn the use of the words: "to

Page Break 117

say such-and-such to oneself" by someone's pointing to a process in the larynx or the brain? Is it not also perfectly possible that my image of the sound *a* and his correspond to different physiological processes? The question is: *How do we compare images?*

Page 117

377. Perhaps a logician will think: The same is the same--how identity is established is a psychological question. (High is high--it is a matter of psychology that one sometimes *sees*, and sometimes *hears* it.)

Page 117

What is the criterion for the sameness of two images?--What is the criterion for the redness of an image? For me, when it is someone else's image: what he says and does. For myself, when it is my image: nothing. And what goes for "red" also goes for "same".

Page 117

378. "Before I judge that two images which I have are the same, I must recognize them as the same." And when that has happened, how am I to know that the word "same" describes what I recognize? Only if I can express my recognition in some other way, and if it is possible for someone else to teach me that "same" is the correct word here.

Page 117

For if I need a justification for using a word, it must also be one for someone else.

Page 117

379. First I am aware of it as *this*; and then I remember what it is called.--Consider: in what cases is it right to say *this*?

Page 117

380. How do I recognize that this is red?--"I see that it is *this*; and then I know that that is what this is called." This?--What?! What kind of answer to this question makes sense?

Page 117

(You keep on steering towards the idea of the *private* ostensive definition.)

Page 117

I could not apply any rules to a private transition from what is seen to words. Here the rules really would hang in the air; for the institution of their use is lacking.

Page 117

381. How do I know that this colour is red?--It would be an answer to say: "I have learnt English".

Page 117

382. At these words I form this image. How can I *justify* this?

Page 117

Has anyone shewn me the image of the colour blue and told me that *this* is the image of blue?

Page 117

What is the meaning of the words: "*This* image"? How does one point to an image? How does one point twice to the same image?

Page Break 118

Page 118

383. We are not analysing a phenomenon (e.g. thought) but a concept (e.g. that of thinking), and therefore the use of a word. So it may look as if what we were doing were Nominalism. Nominalists make the mistake of interpreting all words as *names*, and so of not really describing their use, but only, so to speak, giving a paper draft on such a description.

Page 118

384. You learned the *concept* 'pain' when you learned language.

Page 118

385. Ask yourself: Would it be imaginable for someone to learn to do sums in his head without ever doing written or oral ones?--"Learning it" will mean: being made able to do it. Only the question arises, what will count as a criterion for being able to do it?--But is it also possible for some tribe to know only of calculation in the head, and of no other kind? Here one has to ask oneself: "What will that be like?"--And so one will have to depict it as a limiting case. And the question will then arise whether we are still willing to use the concept of 'calculating in the head' here--or whether in such circumstances it has lost its purpose, because the phenomena gravitate towards another paradigm.

Page 118

386. "But why have you so little confidence in yourself? Ordinarily you always know well enough what it is to 'calculate.' So if you say you have calculated in imagination, then you will have done so. If you had *not* calculated, you would not have said you had. Equally, if you say that you see something red in imagination, then it will *be* red. You know what 'red' is elsewhere.--And further: you do not always rely on the agreement of other people; for you often report that you have seen something no one else has."--But I do have confidence in myself--I say without hesitation that I have done this sum in my head, have imagined this colour. The difficulty is not that I doubt whether I really imagined anything red. But it is *this*: that we should be able, just like that, to point out or describe the colour we have imagined, that the translation of the image into reality presents no difficulty at all. Are they then so alike that one might mix them up?--But I can also recognize a man from a drawing straight off.--Well, but can I ask: "What does a correct image of this colour look like?" or "What sort of thing is it?"; can I *learn* this?

Page 118

(I cannot accept his testimony because it is not *testimony*. It only tells me what he is *inclined* to say.)

Page 118

387. The *deep* aspect of this matter readily eludes us.

Page Break 119

Page 119

388. "I don't see anything violet here, but I can shew it you if you give me a paint box." How can one *know* that one can shew it if...., in other words, that one can recognize it if one sees it?

Page 119

How do I know from my *image*, what the colour really looks like?

Page 119

How do I know that I shall be able to do something? that is, that the state I am in now is that of being able to do that thing?

Page 119

389. "The image must be more like its object than any picture. For, however like I make the picture to what it is supposed to represent, it can always be the picture of something else as well. But it is essential to the image that it is the image of *this* and of nothing else." Thus one might come to regard the image as a super-likeness.

Page 119

390. Could one imagine a stone's having consciousness? And if anyone can do so--why should that not merely prove that such image-mongery is of no interest to us?

Page 119

391. I can perhaps even imagine (though it is not easy) that each of the people whom I see in the street is in frightful pain, but is artfully concealing it. And it is important that I have to imagine an artful concealment here. That I do not simply say to myself: "Well, his soul is in pain: but what has that to do with his body?" or "After all it need not shew in his body!"--And if I imagine this--what do I do; what do I say to myself; how do I look at the people? Perhaps I look at one and think: "It must be difficult to laugh when one is in such pain", and much else of the same kind. I as it were play a part, *act* as if the others were in pain. When I do this I am said for example to be imagining....

Page 119

392. "When I imagine he is in pain, all that really goes on in me is...." Then someone else says: "I believe I can imagine it *without* thinking '....'" ("I believe I can think without words.") This leads to nothing. The analysis oscillates between natural science and grammar.

Page 119

393. "When I imagine that someone who is laughing is really in pain I don't imagine any pain-behaviour, for I see just the opposite. So *what* do I imagine?"--I have already said what. And I do not necessarily imagine *my* being in pain.--"But then what is the process of imagining it?"--Where (outside philosophy) do we use the

words "I can imagine his being in pain" or "I imagine that...." or "Imagine that...."?

Page 120

We say, for example, to someone who has to play a theatrical part: "Here you must imagine that this man is in pain and is concealing it"--and now we give him no directions, do not tell him what he is *actually* to do. For this reason the suggested analysis is not to the point either.--We now watch the actor who is imagining this situation.

Page 120

394. In what sort of circumstances should we ask anyone: "What actually went on in you as you imagined this?"--And what sort of answer do we expect?

Page 120

395. There is a lack of clarity about the role of *imaginability* in our investigation. Namely about the extent to which it ensures that a proposition makes sense.

Page 120

396. It is no more essential to the understanding of a proposition that one should imagine anything in connexion with it, than that one should make a sketch from it.

Page 120

397. Instead of "imaginability" one can also say here: representability by a particular method of representation. And such a representation *may* indeed safely point a way to further use of a sentence. On the other hand a picture may obtrude itself upon us and be of no use at all.

Page 120

398. "But when I imagine something, or even actually *see* objects, I have *got* something which my neighbour has not."--I understand you. You want to look about you and say: "At any rate only I have got THIS."--What are these words for? They serve no purpose.--Can one not add: "There is here no question of a 'seeing'--and therefore none of a 'having'--nor of a subject, nor therefore of 'I' either"? Might I not ask: In what sense have you *got* what you are talking about and saying that only you have got it? Do you possess it? You do not even *see* it. Must you not really say that no one has got it? And this too is clear: if as a matter of logic you exclude other people's having something, it loses its sense to say that you have it.

Page 120

But what is the thing you are speaking of? It is true I said that I knew within myself what you meant. But that meant that I knew how one thinks to conceive this object, to see it, to make one's looking and pointing mean it. I know how one stares ahead and looks about

one in this case--and the rest. I think we can say: you are talking (if, for example, you are sitting in a room) of the 'visual room'. The 'visual room' is the one that has no owner. I can as little own it as I can walk about it, or look at it, or point to it. Inasmuch as it cannot be any one else's it is not mine either. In other words, it does not belong to me *because* I want to use the same form of expression about it as about the material room in which I sit. The description of the latter need not mention an owner, in fact it need not have any owner. But then the visual room *cannot* have any owner. "For"--one might say--"it has no master, outside or in."

Page 121

Think of a picture of a landscape, an imaginary landscape with a house in it.--Someone asks "Whose house is that?"--The answer, by the way, might be "It belongs to the farmer who is sitting on the bench in front of it". But then he cannot for example enter his house.

Page 121

399. One might also say: Surely the owner of the visual room would have to be the same kind of thing as it is; but he is not to be found in it, and there is no outside.

Page 121

400. The 'visual room' seemed like a discovery, but what its discoverer really found was a new way of speaking, a new comparison; it might even be called a new sensation.

Page 121

401. You have a new conception and interpret it as seeing a new object. You interpret a grammatical movement made by yourself as a quasi-physical phenomenon which you are observing. (Think for example of the question: "Are sense-data the material of which the universe is made?")

Page 121

But there is an objection to my saying that you have made a 'grammatical' movement. What you have primarily discovered is a new way of looking at things. As if you had invented a new way of painting; or, again, a

new metre, or a new kind of song.--

Page 121

402. "It's true I say 'Now I am having such-and-such an image', but the words 'I am having' are merely a sign to someone *else*; the description of the image is a *complete* account of the imagined world."--You mean: the words "I am having" are like "I say!...." You are inclined to say it should really have been expressed differently. Perhaps simply by making a sign with one's hand and then giving a description.--When as in this case, we disapprove of the expressions of ordinary language (which are after all performing their office), we have got a picture in our heads which conflicts with the picture of our ordinary

Page Break 122

way of speaking. Whereas we are tempted to say that our way of speaking does not describe the facts as they really are. As if, for example the proposition "he has pains" could be false in some other way than by that man's *not* having pains. As if the form of expression were saying something false even when the proposition *faute de mieux* asserted something true.

Page 122

For *this* is what disputes between Idealists, Solipsists and Realists look like. The one party attack the normal form of expression as if they were attacking a statement; the others defend it, as if they were stating facts recognized by every reasonable human being.

Page 122

403. If I were to reserve the word "pain" solely for what I had hitherto called "my pain", and others "L.W.'s pain", I should do other people no injustice, so long as a notation were provided in which the loss of the word "pain" in other connexions were somehow supplied. Other people would still be pitied, treated by doctors and so on. It would, of course, be *no* objection to this mode of expression to say: "But look here, other people have just the same as you!"

Page 122

But what should I gain from this new kind of account? Nothing. But after all neither does the solipsist want any practical advantage when he advances his view!

Page 122

404. "When I say 'I am in pain', I do not point to a person who is in pain, since in a certain sense I have no idea *who* is." And this can be given a justification. For the main point is: I did not say that such-and-such a person was in pain, but "I am....." Now in saying this I don't name any person. Just as I don't name anyone when I *groan* with pain. Though someone else sees who is in pain from the groaning.

Page 122

What does it mean to know *who* is in pain? It means, for example, to know which man in this room is in pain: for instance, that it is the one who is sitting over there, or the one who is standing in that corner, the tall one over there with the fair hair, and so on.--What am I getting at? At the fact that there is a great variety of criteria for personal '*identity*'.

Page 122

Now which of them determines my saying that '*I*' am in pain? None.

Page 122

405. "But at any rate when you say 'I am in pain', you want to draw the attention of others to a particular person."--The answer might be: No, I want to draw their attention to *myself*--

Page Break 123

Page 123

406. "But surely what you want to do with the words 'I am....' is to distinguish between *yourself* and *other* people."--Can this be said in every case? Even when I merely groan? And even if I do 'want to distinguish' between myself and other people--do I want to distinguish between the person L.W. and the person N.N.?

Page 123

407. It would be possible to imagine someone groaning out: "Someone is in pain--I don't know who!"--and our then hurrying to help him, the one who groaned.

Page 123

408. "But you aren't in doubt whether it is you or someone else who has the pain!"--The proposition "I don't know whether I or someone else is in pain" would be a logical product, and one of its factors would be: "I don't know whether I am in pain or not"--and that is not a significant proposition.

Page 123

409. Imagine several people standing in a ring, and me among them. One of us, sometimes this one,

sometimes that, is connected to the poles of an electrical machine without our being able to see this. I observe the faces of the others and try to see which of us has just been electrified.--Then I say: "Now I *know* who it is; for it's myself." In this sense I could also say: "Now I know who is getting the shocks; it is myself." This would be a rather queer way of speaking.--But if I make the supposition that I can feel the shock even when someone else is electrified, then the expression "Now I know who...." becomes quite unsuitable. It does not belong to this game.

Page 123

410. "I" is not the name of a person, nor "here" of a place, and "this" is not a name. But they are connected with names. Names are explained by means of them. It is also true that it is characteristic of physics not to use these words.

Page 123

411. Consider how the following questions can be applied, and how settled:

Page 123

(1) "Are these books *my* books?"

Page 123

(2) "Is this foot *my* foot?"

Page 123

(3) "Is this body *my* body?"

Page 123

(4) "Is this sensation *my* sensation?"

Each of these questions has practical (non-philosophical) applications.

Page 123

(2) Think of cases in which my foot is anaesthetized or paralysed. Under certain circumstances the question could be settled by determining whether I can feel pain in this foot.

Page Break 124

Page 124

(3) Here one might be pointing to a mirror-image. Under certain circumstances, however, one might touch a body and ask the question. In others it means the same as: "Does my body look like *that*?"

Page 124

(4) Which sensation does one mean by '*this*' one? That is: how is one using the demonstrative pronoun here? Certainly otherwise than in, say, the first example! Here confusion occurs because one imagines that by directing one's attention to a sensation one is pointing to it.

Page 124

412. The feeling of an unbridgeable gulf between consciousness and brain-process: how does it come about that this does not come into the considerations of our ordinary life? This idea of a difference in kind is accompanied by slight giddiness,--which occurs when we are performing a piece of logical sleight-of-hand. (The same giddiness attacks us when we think of certain theorems in set theory.) When does this feeling occur in the present case? It is when I, for example, turn my attention in a particular way on to my own consciousness, and, astonished, say to myself: THIS is supposed to be produced by a process in the brain!--as it were clutching my forehead.--But what can it mean to speak of "turning my attention on to my own consciousness"? This is surely the queerest thing there could be! It was a particular act of gazing that I called doing this. I stared fixedly in front of me--but *not* at any particular point or object. My eyes were wide open, the brows not contracted (as they mostly are when I am interested in a particular object). No such interest preceded this gazing. My glance was vacant; or again *like* that of someone admiring the illumination of the sky and drinking in the light.

Page 124

Now bear in mind that the proposition which I uttered as a paradox (THIS is produced by a brain-process!) has nothing paradoxical about it. I could have said it in the course of an experiment whose purpose was to shew that an effect of light which I see is produced by stimulation of a particular part of the brain.--But I did not utter the sentence in the surroundings in which it would have had an everyday and unparadoxical sense. And my attention was not such as would have accorded with making an experiment. (If it had been, my look would have been intent, not vacant.)

Page 124

413. Here we have a case of introspection, not unlike that from which William James got the idea that the 'self' consisted mainly of 'peculiar motions in the head and between the head and throat'.

Page Break 125

Page 125

And James' introspection shewed, not the meaning of the word "self" (so far as it means something like "person", "human being", "he himself", "I myself"), nor any analysis of such a thing, but the state of a philosopher's attention when he says the word "self" to himself and tries to analyse its meaning. (And a good deal could be learned from this.)

Page 125

414. You think that after all you must be weaving a piece of cloth: because you are sitting at a loom--even if it is empty--and going through the motions of weaving.

Page 125

415. What we are supplying are really remarks on the natural history of human beings; we are not contributing curiosities however, but observations which no one has doubted, but which have escaped remark only because they are always before our eyes.

Page 125

416. "Human beings agree in saying that they see, hear, feel, and so on (even though some are blind and some are deaf). So they are their own witnesses that they have *consciousness*."--But how strange this is! Whom do I really inform, if I say "I have consciousness"? What is the purpose of saying this to myself, and how can another person understand me?--Now, expressions like "I see", "I hear", "I am conscious" really have their uses. I tell a doctor "Now I am hearing with this ear again", or I tell someone who believes I am in a faint "I am conscious again", and so on.

Page 125

417. Do I observe myself, then, and perceive that I am seeing or conscious? And why talk about observation at all? Why not simply say "I perceive I am conscious"?--But what are the words "I perceive" for here?--why not say "I am conscious"?--But don't the words "I perceive" here shew that I am attending to my consciousness?--which is ordinarily not the case.--If so, then the sentence "I perceive I am conscious" does not say that I am conscious, but that my attention is disposed in such-and-such a way.

Page 125

But isn't it a particular experience that occasions my saying "I am conscious again"?--*What* experience? In what situations do we say it?

Page 125

418. Is my having consciousness a fact of experience?--

Page 125

But doesn't one say that a man has consciousness, and that a tree or a stone does not?--What would it be like if it were otherwise?--Would human beings all be unconscious?--No; not in the ordinary sense of the word. But I, for instance, should not have consciousness--as I now in fact have it.

Page Break 126

Page 126

419. In what circumstances shall I say that a tribe has a *chief*? And the chief must surely have *consciousness*. Surely we can't have a chief without consciousness!

Page 126

420. But can't I imagine that the people around me are automata, lack consciousness, even though they behave in the same way as usual?--If I imagine it now--alone in my room--I see people with fixed looks (as in a trance) going about their business--the idea is perhaps a little uncanny. But just try to keep hold of this idea in the midst of your ordinary intercourse with others, in the street, say! Say to yourself, for example: "The children over there are mere automata; all their liveliness is mere automatism." And you will either find these words becoming quite meaningless; or you will produce in yourself some kind of uncanny feeling, or something of the sort.

Page 126

Seeing a living human being as an automaton is analogous to seeing one figure as a limiting case or variant of another; the cross-pieces of a window as a swastika, for example.

Page 126

421. It seems paradoxical to us that we should make such a medley, mixing physical states and states of consciousness up together in a *single* report: "He suffered great torments and tossed about restlessly". It is quite usual; so why do we find it paradoxical? Because we want to say that the sentence deals with both tangibles and intangibles at once.--But does it worry you if I say: "These three struts give the building stability"? Are three and stability tangible?--Look at the sentence as an instrument, and at its sense as its employment.

Page 126

422. What am I believing in when I believe that men have souls? What am I believing in, when I believe that this substance contains two carbon rings? In both cases there is a picture in the foreground, but the sense lies far in

the background; that is, the application of the picture is not easy to survey.

Page 126

423. *Certainly* all these things happen in you.--And now all I ask is to understand the expression we use.--The picture is there. And I am not disputing its validity in any particular case.--Only I also want to understand the application of the picture.

Page 126

424. The picture is *there*; and I do not dispute its *correctness*. But *what* is its application? Think of the picture of blindness as a darkness in the soul or in the head of the blind man.

Page 126

425. In numberless cases we exert ourselves to find a picture and once it is found the application as it were comes about of itself. In

Page Break 127

this case we already have a picture which forces itself on us at every turn,--but does not help us out of the difficulty, which only begins here.

Page 127

If I ask, for example: "How am I to imagine *this* mechanism going into *this* box?"--perhaps a drawing reduced in scale may serve to answer me. Then I can be told: "You see, it goes in like *this*"; or perhaps even: "Why are you surprised? See how it goes *here*; it is the same there". Of course the latter does not explain anything more: it simply invites me to apply the picture I am given.

Page 127

426. A picture is conjured up which seems to fix the sense *unambiguously*. The actual use, compared with that suggested by the picture, seems like something muddled. Here again we get the same thing as in set theory: the form of expression we use seems to have been designed for a god, who knows what we cannot know; he sees the whole of each of those infinite series and he sees into human consciousness. For us, of course, these forms of expression are like pontificals which we may put on, but cannot do much with, since we lack the effective power that would give these vestments meaning and purpose.

Page 127

In the actual use of expressions we make detours, we go by side-roads. We see the straight highway before us, but of course we cannot use it, because it is permanently closed.

Page 127

427. "While I was speaking to him I did not know what was going on in his head." In saying this, one is not thinking of brain-processes, but of thought-processes. The picture should be taken seriously. We should really like to see into his head. And yet we only mean what elsewhere we should mean by saying: we should like to know what he is thinking. I want to say: we have this vivid picture--and that use, apparently contradicting the picture, which expresses the psychical.

Page 127

428. "This queer thing, thought"--but it does not strike us as queer when we are thinking. Thought does not strike us as mysterious while we are thinking, but only when we say, as it were retrospectively: "How was that possible?" How was it possible for thought to deal with the very object *itself*? We feel as if by means of it we had caught reality in our net.

Page 127

429. The agreement, the harmony, of thought and reality consists in this: if I say falsely that something is *red*, then, for all that, it isn't *red*.

Page Break 128

And when I want to explain the word "red" to someone, in the sentence "That is not red", I do it by pointing to something red.

Page 128

430. "Put a ruler against this body; it does not say that the body is of such-and-such a length. Rather is it in itself--I should like to say--dead, and achieves nothing of what thought achieves."--It is as if we had imagined that the essential thing about a living man was the outward form. Then we made a lump of wood in that form, and were abashed to see the stupid block, which hadn't even any similarity to a living being.

Page 128

431. "There is a gulf between an order and its execution. It has to be filled by the act of understanding."

Page 128

"Only in the act of understanding is it meant that we are to do THIS. The *order*--why, that is nothing but

sounds, ink-marks.--"

Page 128

432. Every sign *by itself* seems dead. *What* gives it life?--In use it is *alive*. Is life breathed into it there?--Or is the *use* its life?

Page 128

433. When we give an order, it can look as if the ultimate thing sought by the order had to remain unexpressed, as there is always a gulf between an order and its execution. Say I want someone to make a particular movement, say to raise his arm. To make it quite clear, I do the movement. This picture seems unambiguous till we ask: how does he know that *he is to make that movement*?--How does he know at all what use he is to make of the signs I give him, whatever they are?--Perhaps I shall now try to supplement the order by means of further signs, by pointing from myself to him, making encouraging gestures, etc.. Here it looks as if the order were beginning to stammer.

Page 128

As if the signs were precariously trying to produce understanding in us.--But if we now understand them, by what token do we understand?

Page 128

434. The gesture--we should like to say--*tries* to portray, but cannot do it.

Page 128

435. If it is asked: "How do sentences manage to represent?"--the answer might be: "Don't you know? You certainly see it, when you use them." For nothing is concealed.

Page 128

How do sentences do it?--Don't you know? For nothing is hidden.

Page 128

But given this answer: "But you know how sentences do it, for nothing is concealed" one would like to retort "Yes, but it all goes by so quick, and I should like to see it as it were laid open to view."

Page Break 129

Page 129

436. Here it is easy to get into that dead-end in philosophy, where one believes that the difficulty of the task consists in our having to describe phenomena that are hard to get hold of, the present experience that slips quickly by, or something of the kind. Where we find ordinary language too crude, and it looks as if we were having to do, not with the phenomena of every-day, but with ones that "easily elude us, and, in their coming to be and passing away, produce those others as an average effect". (Augustine: Manifestissima et usitatissima sunt, et eadem rursus nimis latent, et nova est inventio eorum.)

Page 129

437. A wish seems already to know what will or would satisfy it; a proposition, a thought, what makes it true--even when that thing is not there at all! Whence this *determining* of what is not yet there? This despotic demand? ("The hardness of the logical must.")

Page 129

438. "A plan as such is something unsatisfied." (Like a wish, an expectation, a suspicion, and so on.)

Page 129

By this I mean: expectation is unsatisfied, because it is the expectation of something; belief, opinion, is unsatisfied, because it is the opinion that something is the case, something real, something outside the process of believing.

Page 129

439. In what sense can one call wishes, expectations, beliefs, etc. "unsatisfied"? What is our prototype of nonsatisfaction? Is it a hollow space? And would one call that unsatisfied? Wouldn't this be a metaphor too?--Isn't what we call nonsatisfaction a feeling--say hunger?

Page 129

In a particular system of expressions we can describe an object by means of the words "satisfied" and "unsatisfied". For example, if we lay it down that we call a hollow cylinder an "unsatisfied cylinder" and the solid cylinder that fills it "its satisfaction".

Page 129

440. Saying "I should like an apple" does not mean: I believe an apple will quell my feeling of nonsatisfaction. *This* proposition is not an expression of a wish but of nonsatisfaction.

Page 129

441. By nature and by a particular training, a particular education, we are disposed to give spontaneous

expression to wishes in certain circumstances. (A *wish* is, of course, not such a 'circumstance'.) In this game the question whether I know what I wish before my wish is

Page Break 130

fulfilled cannot arise at all. And the fact that some event stops my wishing does not mean that it fulfills it. Perhaps I should not have been satisfied if my wish had been satisfied.

Page 130

On the other hand the word "wish" is also used in this way: "I don't know myself what I wish for." ("For wishes themselves are a veil between us and the thing wished for.")

Page 130

Suppose it were asked "Do I know what I long for before I get it?" If I have learned to talk, then I do know.

Page 130

442. I see someone pointing a gun and say "I expect a report". The shot is fired.--Well, that was what you expected; so did that report somehow already exist in your expectation? Or is it just that there is some other kind of agreement between your expectation and what occurred; that that noise was not contained in your expectation, and merely accidentally supervened when the expectation was being fulfilled?--But no, if the noise had not occurred, my expectation would not have been fulfilled; the noise fulfilled it; it was not an accompaniment of the fulfilment like a second guest accompanying the one I expected.--Was the thing about the event that was not in the expectation too an accident, an extra provided by fate?--But then what was *not* an extra? Did something of the shot already occur in my expectation?--Then what *was* extra? for wasn't I expecting the whole shot?

Page 130

"The report was not so loud as I had expected."--"Then was there a louder bang in your expectation?"

Page 130

443. "The red which you imagine is surely not the same (not the same thing) as the red which you see in front of you; so how can you say that it is what you imagined?"--But haven't we an analogous case with the propositions "Here is a red patch" and "Here there isn't a red patch"? The word "red" occurs in both; so this word cannot indicate the presence of something red.

Page 130

444. One may have the feeling that in the sentence "I expect he is coming" one is using the words "he is coming" in a different sense from the one they have in the assertion "He is coming". But if it were so how could I say that my expectation had been fulfilled? If I wanted to explain the words "he" and "is coming", say by means of ostensive definitions, the same definitions of these words would go for both sentences.

Page 130

But it might now be asked: what's it like for him to come?--The door opens, someone walks in, and so on.--What's it like for me to

Page Break 131

expect him to come?--I walk up and down the room, look at the clock now and then, and so on.--But the one set of events has not the smallest similarity to the other! So how can one use the same words in describing them?--But perhaps I say as I walk up and down: "I expect he'll come in"--Now there is a similarity somewhere. But of what kind?!

Page 131

445. It is in language that an expectation and its fulfilment make contact.

Page 131

446. It would be odd to say: "A process looks different when it happens from when it doesn't happen." Or "A red patch looks different when it is there from when it isn't there--but language abstracts from this difference, for it speaks of a red patch whether it is there or not."

Page 131

447. The feeling is as if the negation of a proposition had to make it true in a certain sense, in order to negate it.

Page 131

(The assertion of the negative proposition contains the proposition which is negated, but not the assertion of it.)

Page 131

448. "If I say I did *not* dream last night, still I must know where to look for a dream; that is, the proposition 'I dreamt', applied to this actual situation, may be false, but mustn't be senseless."--Does that mean, then, that you did after all feel something, as it were the hint of a dream, which made you aware of the place which a dream would

have occupied?

Page 131

Again: if I say "I have no pain in my arm", does that mean that I have a shadow of the sensation of pain, which as it were indicates the place where the pain might be?

Page 131

In what sense does my present painless state contain the possibility of pain?

Page 131

If anyone says: "For the word 'pain' to have a meaning it is necessary that pain should be recognized as such when it occurs"--one can reply: "It is not more necessary than that the absence of pain should be recognized."

Page 131

449. "But mustn't I know what it would be like if I were in pain?"--We fail to get away from the idea that using a sentence involves imagining something for every word.

Page 131

We do not realize that we *calculate*, operate, with words, and in the course of time translate them sometimes into one picture, sometimes into another.--It is as if one were to believe that a written order for a

Page Break 132

cow which someone is to hand over to me always had to be accompanied by an image of a cow, if the order was not to lose its meaning.

Page 132

450. Knowing what someone looks like: being able to call up an image--but also: being able to *mimic* his expression. Need one imagine it in order to mimic it? And isn't mimicking it just as good as imagining it?

Page 132

451. Suppose I give someone the order "Imagine a red circle here"--and now I say: understanding the order means knowing what it is like for it to have been carried out--or even: being able to imagine what it is like.....?

Page 132

452. I want to say: "If someone could see the mental process of expectation, he would necessarily be seeing *what* was being expected."--But that is the case: if you see the expression of an expectation, you see what is being expected. And in what other way, in what other sense would it be possible to see it?

Page 132

453. Anyone who perceived my expectation would necessarily have a direct perception of *what* was being expected. That is to say, he would not have to *infer* it from the process he perceived!--But to say that someone perceives an expectation *makes no sense*. Unless indeed it means, for example, that he perceives the expression of an expectation. To say of an expectant person that he perceives his expectation instead of saying that he expects, would be an idiotic distortion of the expression.

Page 132

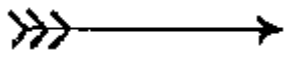
454. "Everything is already there in...." How does it come about that this arrow  *points*? Doesn't it seem to carry in it something besides itself?--"No, not the dead line on paper; only the psychological thing, the meaning, can do that."--That is both true and false. The arrow points only in the application that a living being makes of it.

Page 132

This pointing is *not* a hocus-pocus which can be performed only by the soul.

Page 132

455. We want to say: "When we mean something, it's like going up to someone, it's not having a dead picture (of any kind)." We go up to the thing we mean.

Page 132

456. "When one means something, it is oneself meaning"; so one is oneself in motion. One is rushing ahead and so cannot also observe oneself rushing ahead. Indeed not.

Page Break 133

Page 133

457. Yes: meaning something is like going up to someone.

Page 133

458. "An order orders its own execution." So it knows its execution, then, even before it is there?--But that was a grammatical proposition and it means: If an order runs "Do such-and-such" then executing the order is called "doing such-and-such."

Page 133

459. We say "The order orders *this*--" and do it; but also "The order orders this: I am to...." We translate it at one time into a proposition, at another into a demonstration, and at another into action.

Page 133

460. Could the justification of an action as fulfilment of an order run like this: "You said 'Bring me a yellow flower', upon which this one gave me a feeling of satisfaction; that is why I have brought it"? Wouldn't one have to reply: "But I didn't set you to bring me the flower which should give you that sort of feeling after what I said!"?

Page 133

461. In what sense does an order anticipate its execution? By ordering *just that* which later on is carried out?--But one would have to say "which later on is carried out, or again is not carried out." And that is to say nothing.

Page 133

"But even if my wish does not determine what is going to be the case, still it does so to speak determine the theme of a fact, whether the fact fulfils the wish or not." We are--as it were--surprised, not at anyone's knowing the future, but at his being able to prophesy at all (right or wrong).

Page 133

As if the mere prophecy, no matter whether true or false, foreshadowed the future; whereas it knows nothing of the future and cannot know less than nothing.

Page 133

462. I can look for him when he is not there, but not hang him when he is not there.

Page 133

One might want to say: "But he must be somewhere there if I am looking for him."--Then he must be somewhere there too if I don't find him and even if he doesn't exist at all.

Page 133

463. "You were looking for *him*? You can't even have known if he was there!"--But this problem really does arise when one looks for something in mathematics. One can ask, for example, how was it possible so much as to *look for* the trisection of the angle?

Page 133

464. My aim is: to teach you to pass from a piece of disguised nonsense to something that is patent nonsense.

Page Break 134

Page 134

465. "An expectation is so made that whatever happens has to accord with it, or not."

Page 134

Suppose you now ask: then are facts defined one way or the other by an expectation--that is, is it defined for whatever event may occur whether it fulfils the expectation or not? The answer has to be: "Yes, unless the expression of the expectation is indefinite; for example, contains a disjunction of different possibilities."

Page 134

466. What does man think for? What use is it?--Why does he make boilers according to *calculations* and not leave the thickness of their walls to chance? After all it is only a fact of experience that boilers do not explode so often if made according to these calculations. But just as having once been burnt he would do anything rather than put his hand into a fire, so he would do anything rather than not calculate for a boiler.--But as we are not interested in causes,--we shall say: human beings do in fact think: this, for instance, is how they proceed when they make a boiler.--Now, can't a boiler produced in this way explode? Oh, yes.

Page 134

467. Does man think, then, because he has found that thinking pays?--Because he thinks it advantageous to think?

Page 134

(Does he bring his children up because he has found it pays?)

Page 134

468. What would shew *why* he thinks?

Page 134

469. And yet one can say that thinking has been found to pay. That there are fewer boiler explosions than formerly, now that we no longer go by feeling in deciding the thickness of the walls, but make such-and-such calculations instead. Or since each calculation done by one engineer got checked by a second one.

Page 134

470. So we do *sometimes* think because it has been found to pay.

471. It often happens that we only become aware of the important *facts*, if we suppress the question "why?"; and then in the course of our investigations these facts lead us to an answer.

472. The character of the belief in the uniformity of nature can perhaps be seen most clearly in the case in which we fear what we expect. Nothing could induce me to put my hand into a flame--although after all it is *only in the past* that I have burnt myself.

473. The belief that fire will burn me is of the same kind as the fear that it will burn me.

474. I shall get burnt if I put my hand in the fire: that is certainty.

That is to say: here we see the meaning of certainty. (What it amounts to, not just the meaning of the word "certainty.")

475. On being asked for the grounds of a supposition, one *bethinks* oneself of them. Does the same thing happen here as when one considers what may have been the causes of an event?

476. We should distinguish between the object of fear and the cause of fear.

Thus a face which inspires fear or delight (the object of fear or delight), is not on that account its cause, but--one might say--its target.

477. "Why do you believe that you will burn yourself on the hot-plate?"--Have you reasons for this belief; and do you need reasons?

478. What kind of reason have I to assume that my finger will feel a resistance when it touches the table? What kind of reason to believe that it will hurt if this pencil pierces my hand?--When I ask this, a hundred reasons present themselves, each drowning the voice of the others. "But I have experienced it myself innumerable times, and as often heard of similar experiences; if it were not so, it would; etc."

479. The question: "On what grounds do you believe this?" might mean: "From what you are now deducing it (have you just deduced it)?" But it might also mean: "What grounds can you produce for this assumption on thinking it over?"

480. Thus one could in fact take "grounds" for an opinion to mean only what a man had said to himself before he arrived at the opinion. The calculation that he has actually carried out. If it is now asked: But how *can* previous experience be a ground for assuming that such-and-such will occur later on?--the answer is: What general concept have we of grounds for this kind of assumption? This sort of statement about the past is simply what we call a ground for assuming that this will happen in the future.--And if you are surprised at our playing such a game I refer you to the *effect* of a past experience (to the fact that a burnt child fears the fire).

481. If anyone said that information about the past could not convince him that something would happen in the future, I should not understand him. One might ask him: What do you expect to be told, then? What sort of information do you call a ground for such a belief? What do you call "conviction"? In what kind of way do you expect to be convinced?--If *these* are not grounds, then what are grounds?--If you say these are not grounds, then you must surely be able to state what must be the case for us to have the right to say that there are grounds for our assumption.

For note: here grounds are not propositions which logically imply what is believed.

Not that one can say: less is needed for belief than for knowledge.--For the question here is not one of an approximation to logical inference.

482. We are misled by this way of putting it: "This is a good ground, for it makes the occurrence of the event probable." That is as if we had asserted something further about the ground, which justified it as a ground; whereas to say that this ground makes the occurrence probable is to say nothing except that this ground comes up to a particular standard of good grounds--but the standard has no grounds!

483. A good ground is one that looks *like this*.

484. One would like to say: "It is a good ground only because it makes the occurrence *really* probable". Because it, so to speak, really has an influence on the event; as it were an experiential one.

485. Justification by experience comes to an end. If it did not it would not be justification.

486. Does it *follow* from the sense-impressions which I get that there is a chair over there?--How can a *proposition* follow from sense-impressions? Well, does it follow from the propositions which describe the sense-impressions? No.--But don't I infer that a chair is there from impressions, from sense-data?--I make no inference!--and yet I sometimes do. I see a photograph for example, and say "There must have been a chair over there" or again "From what I can see here I infer that there is a chair over there." That is an inference; but not one belonging to logic. An inference is a transition to an assertion; and so also to the behaviour that corresponds to the assertion. 'I draw the consequences' not only in words, but also in action.

Was I justified in drawing these consequences? What is *called* a justification here?--How is the word "justification" used? Describe language-games. From these you will also be able to see the importance of being justified.

487. "I am leaving the room because you tell me to."

"I am leaving the room, but not because you tell me to."

Does this proposition *describe* a connexion between my action and his order; or does it make the connexion?

Can one ask: "How do you know that you do it because of this, or not because of this?" And is the answer perhaps: "I feel it"?

488. How do I judge whether it is so? By circumstantial evidence?

489. Ask yourself: On what occasion, for what purpose, do we say this?

What kind of actions accompany these words? (Think of a greeting.) In what scenes will they be used; and what for?

490. How do I know that *this line of thought* has led me to this action?--Well, it is a particular picture: for example, of a calculation leading to a further experiment in an experimental investigation. It looks like *this*--and now I could describe an example.

491. Not: "without language we could not communicate with one another"--but for sure: without language we cannot influence other people in such-and-such ways; cannot build roads and machines, etc.. And also: without the use of speech and writing people could not communicate.

492. To invent a language could mean to invent an instrument for a particular purpose on the basis of the laws of nature (or consistently with them); but it also has the other sense, analogous to that in which we speak of the invention of a game.

Here I am stating something about the grammar of the word "language", by connecting it with the grammar

of the word "invent".

Page 137

493. We say: "The cock calls the hens by crowing"--but doesn't a comparison with our language lie at the bottom of this?--Isn't the aspect quite altered if we imagine the crowing to set the hens in motion by some kind of physical causation?

Page 137

But if it were shewn how the words "Come to me" act on the person addressed, so that finally, given certain conditions, the muscles of his

Page Break 138

legs are innervated, and so on--should we feel that that sentence lost the character of a *sentence*?

Page 138

494. I want to say: It is *primarily* the apparatus of our ordinary language, of our word-language, that we call language; and then other things by analogy or comparability with this.

Page 138

495. Clearly, I can establish by experience that a human being (or animal) reacts to one sign as I want him to, and to another not. That, e.g., a human being goes to the right at the sign "→" and goes to the left at the sign "←"; but that he does not react to the sign "  ", as to "→".

Page 138

I do not even need to fabricate a case, I only have to consider what is in fact the case; namely, that I can direct a man who has learned only German, only by using the German language. (For here I am looking at learning German as adjusting a mechanism to respond to a certain kind of influence; and it may be all one to us whether someone else has learned the language, or was perhaps from birth constituted to react to sentences in German like a normal person who has learned German.)

Page 138

496. Grammar does not tell us how language must be constructed in order to fulfil its purpose, in order to have such-and-such an effect on human beings. It only describes and in no way explains the use of signs.

Page 138

497. The rules of grammar may be called "arbitrary", if that is to mean that the *aim* of the grammar is nothing but that of the language.

Page 138

If someone says "If our language had not this grammar, it could not express these facts"--it should be asked what "*could*" means here.

Page 138

498. When I say that the orders "Bring me sugar" and "Bring me milk" make sense, but not the combination "Milk me sugar", that does not mean that the utterance of this combination of words has no effect. And if its effect is that the other person stares at me and gapes, I don't on that account call it the order to stare and gape, even if that was precisely the effect that I wanted to produce.

Page 138

499. To say "This combination of words makes no sense" excludes it from the sphere of language and thereby bounds the domain of language. But when one draws a boundary it may be for various kinds of reason. If I surround an area with a fence or a line or otherwise, the purpose may be to prevent someone from getting in or out;

Page Break 139

but it may also be part of a game and the players be supposed, say, to jump over the boundary; or it may shew where the property of one man ends and that of another begins; and so on. So if I draw a boundary line that is not yet to say what I am drawing it for.

Page 139

500. When a sentence is called senseless, it is not as it were its sense that is senseless. But a combination of words is being excluded from the language, withdrawn from circulation.

Page 139

501. "The purpose of language is to express thoughts."--So presumably the purpose of every sentence is to express a thought. Then what thought is expressed, for example, by the sentence "It's raining"?--

Page 139

502. Asking what the sense is. Compare:

"This sentence makes sense."--"What sense?"

"This set of words is a sentence."--"What sentence?"

503. If I give anyone an order I feel it to be *quite enough* to give him signs. And I should never say: this is only words, and I have got to get behind the words. Equally, when I have asked someone something and he gives me an answer (i.e. a sign) I am content--that was what I expected--and I don't raise the objection: but that's a mere answer.

504. But if you say: "How am I to know what he means, when I see nothing but the signs he gives?" then I say: "How is *he* to know what he means, when he has nothing but the signs either?"

505. Must I understand an order before I can act on it?--Certainly, otherwise you wouldn't know what you had to do!--But isn't there in turn a jump from *knowing* to doing?--

506. The absent-minded man who at the order "Right turn!" turns left, and then, clutching his forehead, says "Oh! right turn" and does a right turn.--What has struck him? An interpretation?

507. "I am not merely saying this, I mean something by it."--When we consider what is going on in us when we *mean* (and don't merely say) words, it seems to us as if there were something coupled to these words, which otherwise would run idle.--As if they, so to speak, connected with something in us.

508. I say the sentence: "The weather is fine"; but the words are after all arbitrary signs--so let's put "a b c d" in their place. But now when I read this, I can't connect it straight away with the above sense.--

I am not used, I might say, to saying "a" instead of "the", "b" instead of "weather", etc.. But I don't mean by that that I am not used to making an immediate association between the word "the" and "a", but that I am not used to using "a" *in the place* of "the"--and therefore in the sense of "the". (I have not mastered this language.)

(I am not used to measuring temperatures on the Fahrenheit scale. Hence such a measure of temperature 'says' nothing to me.)

509. Suppose we asked someone "In what sense are these words a description of what you are seeing?"--and he answers: "I *mean* this by these words." (Say he was looking at a landscape.) Why is this answer "I *mean* this...." no answer at all?

How does one use words to *mean* what one sees before one?

Suppose I said "a b c d" and meant: the weather is fine. For as I uttered these signs I had the experience normally had only by someone who had year-in year-out used "a" in the sense of "the", "b" in the sense of "weather", and so on.--Does "a b c d" now mean: the weather is fine?

What is supposed to be the criterion for my having had *that* experience?

510. Make the following experiment: *say* "It's cold here" and *mean* "It's warm here". Can you do it?--And what are you doing as you do it? And is there only one way of doing it?

511. What does "discovering that an expression doesn't make sense" mean?--and what does it mean to say: "If I mean something by it, surely it must make sense"?--If I mean something by it?--If I mean *what* by it?!--One wants to say: a significant sentence is one which one can not merely say, but also think.

512. It looks as if we could say: "Word-language allows of senseless combinations of words, but the language of imagining does not allow us to imagine anything senseless."--Hence, too, the language of drawing doesn't allow of senseless drawings? Suppose they were drawings from which bodies were supposed to be modelled. In this case some drawings make sense, some not.--What if I imagine senseless combinations of words?

513. Consider the following form of expression: "The number of pages in my book is equal to a root of the equation $x^3 + 2x - 3 = 0$." Or: "I have n friends and $n^2 + 2n + 2 = 0$ ". Does this sentence make sense? This cannot be seen immediately. This example shews

how it is that something can look like a sentence which we understand, and yet yield no sense.

(This throws light on the concepts 'understanding' and 'meaning'.)

514. A philosopher says that he understands the sentence "I am here", that he means something by it, thinks something--even when he doesn't think at all how, on what occasions, this sentence is used. And if I say "A rose is red in the dark too" you positively see this red in the dark before you.

515. Two pictures of a rose in the dark. One is quite black; for the rose is invisible. In the other, it is painted in full detail and surrounded by black. Is one of them right, the other wrong? Don't we talk of a white rose in the dark and of a red rose in the dark? And don't we say for all that that they can't be distinguished in the dark?

516. It seems clear that we understand the meaning of the question: "Does the sequence 7777 occur in the development of π ?" It is an English sentence; it can be shown what it means for 415 to occur in the development of π ; and similar things. Well, our understanding of that question reaches just so far, one may say, as such explanations reach.

517. The question arises: Can't we be mistaken in thinking that we understand a question?

For many mathematical proofs do lead us to say that we *cannot* imagine something which we believed we could imagine. (E.g., the construction of the heptagon.) They lead us to revise what counts as the domain of the imaginable.

518. Socrates to Theaetetus: "And if someone thinks mustn't he think *something*?"--Th.: "Yes, he must."--Soc.: "And if he thinks something, mustn't it be something real?"--Th.: "Apparently."

And mustn't someone who is painting be painting something--and someone who is painting something be painting something real!--Well, tell me what the object of painting is: the picture of a man (e.g.), or the man that the picture portrays?

519. One wants to say that an order is a picture of the action which was carried out on the order; but also that it is a picture of the action which *is to be* carried out on the order.

520. "If a proposition too is conceived as a picture of a possible state of affairs and is said to shew the possibility of the state of affairs,

still the most that the proposition can do is what a painting or relief or film does: and so it can at any rate not set forth what is not the case. So does it depend wholly on our grammar what will be called (logically) possible and what not,--i.e. what that grammar permits?"--But surely that is arbitrary!--Is it arbitrary?--It is not every sentence-like formation that we know how to do something with, not every technique has an application in our life; and when we are tempted in philosophy to count some quite useless thing as a proposition, that is often because we have not considered its application sufficiently.

521. Compare 'logically possible' with 'chemically possible'. One might perhaps call a combination chemically possible if a formula with the right valencies existed (e.g. H - O - O - O - H). Of course such a combination need not exist; but even the formula HO₂ cannot have less than no combination corresponding to it in reality.

522. If we compare a proposition to a picture, we must think whether we are comparing it to a portrait (a historical representation) or to a genre-picture. And both comparisons have point.

When I look at a genre-picture, it 'tells' me something, even though I don't believe (imagine) for a moment that the people I see in it really exist, or that there have really been people in that situation. But suppose I ask: "What does it tell me, then?"

523. I should like to say "What the picture tells me is itself." That is, its telling me something consists in its own structure, in *its* own lines and colours. (What would it mean to say "What this musical theme tells me is itself"?)

524. Don't take it as a matter of course, but as a remarkable fact, that pictures and fictitious narratives give us pleasure, occupy our minds.

("Don't take it as a matter of course" means: find it surprising, as you do some things which disturb you. Then the puzzling aspect of the latter will disappear, by your accepting this fact as you do the other.)

((The transition from patent nonsense to something which is disguised nonsense.))

525. "After he had said this, he left her as he did the day before."--Do I understand this sentence? Do I understand it just as I should if I heard it in the course of a narrative? If it were set down in isolation

I should say, I don't know what it's about. But all the same I should know how this sentence might perhaps be used; I could myself invent a context for it.

(A multitude of familiar paths lead off from these words in every direction.)

526. What does it mean to understand a picture, a drawing? Here too there is understanding and failure to understand. And here too these expressions may mean various kinds of thing. A picture is perhaps a still-life; but I don't understand one part of it: I cannot see solid objects there, but only patches of colour on the canvas.--Or I see everything as solid but there are objects that I am not acquainted with (they look like implements, but I don't know their use).--Perhaps, however, I am acquainted with the objects, but in another sense do not understand the way they are arranged.

527. Understanding a sentence is much more akin to understanding a theme in music than one may think. What I mean is that understanding a sentence lies nearer than one thinks to what is ordinarily called understanding a musical theme. Why is just *this* the pattern of variation in loudness and tempo? One would like to say "Because I know what it's all about." But what is it all about? I should not be able to say. In order to 'explain' I could only compare it with something else which has the same rhythm (I mean the same pattern). (One says "Don't you see, this is as if a conclusion were being drawn" or "This is as it were a parenthesis", etc. How does one justify such comparisons?--There are very different kinds of justification here.)

528. It would be possible to imagine people who had something not quite unlike a language: a play of sounds, without vocabulary or grammar. ('Speaking with tongues.')

529. "But what would the meaning of the sounds be in such a case?"--What is it in music? Though I don't at all wish to say that this language of a play of sounds would have to be compared to music.

530. There might also be a language in whose use the 'soul' of the words played no part. In which, for example, we had no objection to replacing one word by another arbitrary one of our own invention.

531. We speak of understanding a sentence in the sense in which it can be replaced by another which says the same; but also in the sense

in which it cannot be replaced by any other. (Any more than one musical theme can be replaced by another.)

In the one case the thought in the sentence is something common to different sentences; in the other, something that is expressed only by these words in these positions. (Understanding a poem.)

532. Then has "understanding" two different meanings here?--I would rather say that these kinds of use of "understanding" make up its meaning, make up my *concept* of understanding.

For I *want* to apply the word "understanding" to all this.

533. But in the second case how can one explain the expression, transmit one's comprehension? Ask yourself: How does one *lead* anyone to comprehension of a poem or of a theme? The answer to this tells us how meaning is explained here.

534. *Hearing* a word in a particular sense. How queer that there should be such a thing!

Phrased *like this*, emphasized like this, heard in this way, this sentence is the first of a series in which a transition is made to *these* sentences, pictures, actions.

((A multitude of familiar paths lead off from these words in every direction.))

535. What happens when we learn to *feel* the ending of a church mode as an ending?

536. I say: "I can think of this face (which gives an impression of timidity) as courageous too." We do not mean by this that I can imagine someone with this face perhaps saving someone's life (that, of course, is imaginable in connexion with any face). I am speaking rather of an aspect of the face itself. Nor do I mean that I can imagine that this man's face might change so that, in the ordinary sense, it looked courageous; though I may very well mean that there is a quite definite way in which it can change into a courageous face. The reinterpretation of a facial expression can be compared to the reinterpretation of a chord in music, when we hear it as a modulation first into this, then into that key.

537. It is possible to say "I read timidity in this face" but at all events the timidity does not seem to be merely associated, outwardly connected, with the face; but fear is there, alive, in the features. If the features change slightly, we can speak of a corresponding change in the

fear. If we were asked "Can you think of this face as an expression of courage too?"--we should, as it were, not know how to lodge courage in these features. Then perhaps I say "I don't know what it would mean for this to be a courageous face." But what would an answer to such a question be like? Perhaps one says: "Yes, now I understand: the face as it were shews indifference to the outer world." So we have somehow read courage into the face. Now once more, one might say, courage *fits* this face. But *what* fits *what* here?

538. There is a related case (though perhaps it will not seem so) when, for example, we (Germans) are surprised that in French the predicative adjective agrees with the substantive in gender, and when we explain it to ourselves by saying: they mean: "the man is *a good one*."

539. I see a picture which represents a smiling face. What do I do if I take the smile now as a kind one, now as malicious? Don't I often imagine it with a spatial and temporal context which is one either of kindness or malice? Thus I might supply the picture with the fancy that the smiler was smiling down on a child at play, or again on the suffering of an enemy.

This is in no way altered by the fact that I can also take the at first sight gracious situation and interpret it differently by putting it into a wider context.--If no special circumstances reverse my interpretation I shall conceive a particular smile as kind, call it a "kind" one, react correspondingly.

((Probability, frequency.))

540. "Isn't it very odd that I should be unable--even *without* the institution of language and all its surroundings--to think that it will soon stop raining?"--Do you want to say that it is queer that you should be unable to say these words and *mean* them without those surroundings?

Suppose someone were to point at the sky and come out with a number of unintelligible words. When we ask him what he means he explains that the words mean "Thank heaven, it'll soon stop raining." He even explains to us the meaning of the individual words.--I will suppose him suddenly to come to himself and say that the sentence

was completely senseless, but that when he spoke it it had seemed to him like a sentence in a language he knew. (Positively)

Page Break 146

like a familiar quotation.)--What am I to say now? Didn't he understand the sentence as he was saying it? Wasn't the whole meaning there in the sentence?

Page 146

541. But what did his understanding, and the meaning, consist in? He uttered the sounds in a cheerful voice perhaps, pointing to the sky, while it was still raining but was already beginning to clear up; *later* he made a connexion between his words and the English words.

Page 146

542. "But the point is, the words felt to him like the words of a language he knew well."--Yes: a criterion for that is that he later said just *that*. And now do *not* say: "The feel of the words in a language we know is of a quite particular kind." (What is the *expression* of this feeling?)

Page 146

543. Can I not say: a cry, a laugh, are full of meaning?

Page 146

And that means, roughly: much can be gathered from them.

Page 146

544. When longing makes me cry "Oh, if only he would come!" the feeling gives the words 'meaning'. But does it give the individual words their meanings?

Page 146

But here one could also say that the feeling gave the words *truth*. And from this you can see how the concepts merge here. (This recalls the question: what is the *meaning* of a mathematical proposition?)

Page 146

545. But when one says "I *hope* he'll come"--doesn't the feeling give the word "hope" its meaning? (And what about the sentence "I do *not* hope for his coming any longer"?) The feeling does perhaps give the word "hope" its special ring; that is, it is expressed in that ring.--If the feeling gives the word its meaning, then here "meaning" means *point*. But why is the feeling the point?

Page 146

Is hope a feeling? (Characteristic marks.)

Page 146

546. In this way I should like to say the words "Oh, *let* him come!" are charged with my desire. And words can be wrung from us,--like a cry. Words can be hard to say: such, for example, as are used to effect a renunciation, or to confess a weakness. (Words are also deeds.)

Page 146

547. Negation: a 'mental activity'. Negate something and observe what you are doing.--Do you perhaps inwardly shake your head? And if you do--is this process more deserving of our interest than, say,

Page Break 147

that of writing a sign of negation in a sentence? Do you now know the *essence* of negation?

Page 147

548. What is the difference between the two processes: wishing that something should happen--and wishing that the same thing should *not* happen?

Page 147

If we want to represent it pictorially, we shall treat the picture of the event in various ways: cross it out, put a line round it, and so on. But this strikes us as a *crude* method of expression. In word-language indeed we use the sign "not". But this is like a clumsy expedient. We think that in *thought* it is arranged differently.

Page 147

549. "How can the word 'not' negate?"--"The sign 'not' indicates that you are to take what follows negatively." We should like to say: The sign of negation is our occasion for doing something--possibly something very complicated. It is as if the negation-sign occasioned our doing something. But what? That is not said. It is as if it only needed to be hinted at; as if we already knew. As if no explanation were needed, for we are in any case already acquainted with the matter.

Page 147

(a) "The fact that three negatives yield a negative again must already be contained in the single negative that I

am using now." (The temptation to invent a myth of 'meaning'.)

Page 147

It looks as if it followed from the nature of negation that a double negative is an affirmative. (And there is something right about this. What? *Our* nature is connected with both.)

Page 147

(b) There cannot be a question whether these or other rules are the correct ones for the use of "not". (I mean, whether they accord with its meaning.) For without these rules the word has as yet no meaning; and if we change the rules, it now has another meaning (or none), and in that case we may just as well change the word too.

Page 147

550. Negation, one might say, is a gesture of exclusion, of rejection. But such a gesture is used in a great variety of cases!551. "Does the *same* negation occur in: 'Iron does not melt at a hundred degrees Centigrade' and 'Twice two is not five'?" Is this to be decided by introspection; by trying to see what we are *thinking* as we utter the two sentences?

Page 147

552. Suppose I were to ask: is it clear to us, while we are uttering the sentences "This rod is one yard long" and "Here is one soldier",

Page Break 148

that we mean different things by "one", that "one" has different meanings?--Not at all.--Say e.g. such a sentence as "One yard is occupied by one soldier, and so two yards are occupied by two soldiers." Asked "Do you mean the same thing by both 'ones'?" one would perhaps answer: "Of course I mean the same thing: *one*!" (Perhaps raising one finger.)

Page 148

553. Now has "1" a different meaning when it stands for a measure and when it stands for a number? If the question is framed in *this* way, one will answer in the affirmative.

Page 148

554. We can easily imagine human beings with a 'more primitive' logic, in which something corresponding to our negation is applied only to certain sorts of sentence; perhaps to such as do not themselves contain any negation. It would be possible to negate the proposition "He is going into the house", but a negation of the negative proposition would be meaningless, or would count only as a repetition of the negation. Think of means of expressing negation different from ours: by the pitch of one's voice, for instance. What would a double negation be like there?

Page 148

555. The question whether negation had the same meaning to these people as to us would be analogous to the question whether the figure "5" meant the same to people whose numbers ended at 5 as to us.

Page 148

556. Imagine a language with two different words for negation, "X" and "Y". Doubling "X" yields an affirmative, doubling "Y" a strengthened negative. For the rest the two words are used alike.--Now have "X" and "Y" the same meaning in sentences where they occur without being repeated?--We could give various answers to this.

Page 148

(a) The two words have different uses. So they have different meanings. But sentences in which they occur without being repeated and which for the rest are the same make the same sense.

Page 148

(b) The two words have the same function in language-games, except for this one difference, which is just a trivial convention. The use of the two words is taught in the same way, by means of the same actions, gestures, pictures and so on; and in explanations of the words the difference in the ways they are used is appended as something incidental, as one of the capricious features of the language. For this reason we shall say that "X" and "Y" have the same meaning.

Page 148

(c) We connect different images with the two negatives. "X" as it

Page Break 149

were turns the sense through 180°. And *that* is why two such negatives restore the sense to its former position. "Y" is like a shake of the head. And just as one does not annul a shake of the head by shaking it again, so also one doesn't cancel one "Y" by a second one. And so even if, practically speaking, sentences with the two signs of negation come to the same thing, still "X" and "Y" express different ideas.

557. Now, when I uttered the double negation, what constituted my meaning it as a strengthened negative and not as an affirmative? There is no answer running: "It consisted in the fact that...." In certain circumstances instead of saying "This duplication is meant as a strengthening," I can *pronounce* it as a strengthening. Instead of saying "The duplication of the negative is meant to cancel it" I can e.g. put brackets.--"Yes, but after all these brackets may themselves have various roles; for who says that they are to be taken as *brackets*?" No one does. And haven't you explained your own conception in turn by means of words? The meaning of the brackets lies in the technique of applying them. The question is: under what circumstances does it make sense to say "I meant....", and what circumstances justify me in saying "He meant...."?

558. What does it mean to say that the "is" in "The rose is red" has a different meaning from the "is" in "twice two is four"? If it is answered that it means that different rules are valid for these two words, we can say that we have only *one* word here.--And if all I am attending to is grammatical rules, these do allow the use of the word "is" in both connexions.--But the rule which shews that the word "is" has different meanings in these sentences is the one allowing us to replace the word "is" in the second sentence by the sign of equality, and forbidding this substitution in the first sentence.

559. One would like to speak of the function of a word in *this* sentence. As if the sentence were a mechanism in which the word had a particular function. But what does this function consist in? How does it come to light? For there isn't anything hidden--don't we see the whole sentence? The function must come out in operating with the word. ((Meaning-body.))

560. "The meaning of a word is what is explained by the explanation of the meaning." I.e.: if you want to understand the use of the word "meaning", look for what are called "explanations of meaning".

561. Now isn't it queer that I say that the word "is" is used with two different meanings (as the copula and as the sign of equality), and should not care to say that its meaning is its use; its use, that is, as the copula and the sign of equality?

One would like to say that these two kinds of use do not yield a *single* meaning; the union under one head is an accident, a mere inessential.

562. But how can I decide what is an essential, and what an inessential, accidental, feature of the notation? Is there some reality lying behind the notation, which shapes its grammar?

Let us think of a similar case in a game: in draughts a king is marked by putting one piece on top of another. Now won't one say it is inessential to the game for a king to consist of two pieces?

563. Let us say that the meaning of a piece is its role in the game.--Now let it be decided by lot which of the players gets white before any game of chess begins. To this end one player holds a king in each closed fist while the other chooses one of the two hands at random. Will it be counted as part of the role of the king in chess that it is used to draw lots in this way?

564. So I am inclined to distinguish between the essential and the inessential in a game too. The game, one would like to say, has not only rules but also a *point*.

565. Why the same word? In the calculus we make no use of this identity!--Why the same piece for both purposes?--But what does it mean here to speak of "making use of the identity"? For isn't it a use, if we do in fact use the same word?

566. And now it looks as if the use of the same word or the same piece, had a *purpose*--if the identity is not accidental, inessential. And as if the purpose were that one should be able to recognize the piece and know how to play.--Are we talking about a physical or a logical possibility here? If the latter then the identity of the piece is something to do with the game.

567. But, after all, the game is supposed to be defined by the rules! So, if a rule of the game prescribes that the kings are to be used for drawing lots before a game of chess, then that is an essential part of the game. What objection might one make to this? That one does not see the point of this prescription. Perhaps as one wouldn't see the point either of a rule by which each piece had to be turned round three times

Page Break 151

before one moved it. If we found this rule in a board-game we should be surprised and should speculate about the purpose of the rule. ("Was this prescription meant to prevent one from moving without due consideration?")

Page 151

568. If I understand the character of the game aright--I might say--then this isn't an essential part of it.

Page 151

((Meaning is a physiognomy.))

Page 151

569. Language is an instrument. Its concepts are instruments. Now perhaps one thinks that it can make no *great* difference *which* concepts we employ. As, after all, it is possible to do physics in feet and inches as well as in metres and centimetres; the difference is merely one of convenience. But even this is not true if, for instance, calculations in some system of measurement demand more time and trouble than it is possible for us to give them.

Page 151

570. Concepts lead us to make investigations; are the expression of our interest, and direct our interest.

Page 151

571. Misleading parallel: psychology treats of processes in the psychical sphere, as does physics in the physical.

Page 151

Seeing, hearing, thinking, feeling, willing, are not the subject of psychology *in the same sense* as that in which the movements of bodies, the phenomena of electricity etc., are the subject of physics. You can see this from the fact that the physicist sees, hears, thinks about, and informs us of these phenomena, and the psychologist observes the *external reactions* (the behaviour) of the subject.

Page 151

572. Expectation is, grammatically, a state; like: being of an opinion, hoping for something, knowing something, being able to do something. But in order to understand the grammar of these states it is necessary to ask: "What counts as a criterion for anyone's being in such a state?" (States of hardness, of weight, of fitting.)

Page 151

573. To have an opinion is a state.--A state of what? Of the soul? Of the mind? Well, of what object does one say that it has an opinion? Of Mr. N.N. for example. And that is the correct answer.

Page 151

One should not expect to be enlightened by the answer to *that* question. Others go deeper: What, in particular cases, do we regard as criteria for someone's being of such-and-such an opinion? When do we say: he reached this opinion at that time? When: he has altered his opinion? And so on. The picture which the answers to these questions give us shews *what* gets treated grammatically as a *state* here.

Page Break 152

Page 152

574. A proposition, and hence in another sense a thought, can be the 'expression' of belief, hope, expectation, etc. But believing is not thinking. (A grammatical remark.) The concepts of believing, expecting, hoping are less distantly related to one another than they are to the concept of thinking.

Page 152

575. When I sat down on this chair, of course I believed it would bear me. I had no thought of its possibly collapsing.

Page 152

But: "In spite of everything that he did, I held fast to the belief..." Here there is thought, and perhaps a constant struggle to renew an attitude.

Page 152

576. I watch a slow match burning, in high excitement follow the progress of the burning and its approach to the explosive. Perhaps I don't think anything at all or have a multitude of disconnected thoughts. This is certainly a case of expecting.

Page 152

577. We say "I am expecting him", when we believe that he will come, though his coming does not *occupy*

our thoughts. (Here "I am expecting him" would mean "I should be surprised if he didn't come" and that will not be called the description of a state of mind.) But we also say "I am expecting him" when it is supposed to mean: I am eagerly awaiting him. We could imagine a language in which different verbs were consistently used in these cases. And similarly more than one verb where we speak of 'believing', 'hoping' and so on. Perhaps the concepts of such a language would be more suitable for understanding psychology than the concepts of our language.

Page 152

578. Ask yourself: What does it mean to *believe* Goldbach's theorem? What does this belief consist in? In a feeling of certainty as we state, hear, or think the theorem? (That would not interest us.) And what are the characteristics of this feeling? Why, I don't even know how far the feeling may be caused by the proposition itself.

Page 152

Am I to say that belief is a particular colouring of our thoughts? Where does this idea come from? Well, there is a tone of belief, as of doubt.

Page 152

I should like to ask: how does the belief connect with this proposition? Let us look and see what are the consequences of this belief, where it takes us. "It makes me search for a proof of the proposition."--Very well; and now let us look and see what your searching really consists in. Then we shall know what belief in the proposition amounts to.

Page Break 153

Page 153

579. The feeling of confidence. How is this manifested in behaviour?

Page 153

580. An 'inner process' stands in need of outward criteria.

Page 153

581. An expectation is imbedded in a situation, from which it arises. The expectation of an explosion may, for example, arise from a situation in which an explosion *is to be expected*.

Page 153

582. If someone whispers "It'll go off now", instead of saying "I expect the explosion any moment", still his words do not describe a feeling; although they and their tone may be a manifestation of his feeling.

Page 153

583. "But you talk as if I weren't really expecting, hoping, *now*--as I thought I was. As if what were happening *now* had no deep significance."--What does it mean to say "What is happening now has significance" or "has deep significance"? What is a *deep* feeling? Could someone have a feeling of ardent love or hope for the space of one second--*no matter what* preceded or followed this second?--What is happening now has significance--in these surroundings. The surroundings give it its importance. And the word "hope" refers to a phenomenon of human life. (A smiling mouth *smiles* only in a human face.)

Page 153

584. Now suppose I sit in my room and hope that N.N. will come and bring me some money, and suppose one minute of this state could be isolated, cut out of its context; would what happened in it then not be hope?--Think, for example, of the words which you perhaps utter in this space of time. They are no longer part of this language. And in different surroundings the institution of money doesn't exist either.

Page 153

A coronation is the picture of pomp and dignity. Cut one minute of this proceeding out of its surroundings: the crown is being placed on the head of the king in his coronation robes.--But in different surroundings gold is the cheapest of metals, its gleam is thought vulgar. There the fabric of the robe is cheap to produce. A crown is a parody of a respectable hat. And so on.

Page 153

585. When someone says "I hope he'll come"--is this a *report* about his state of mind, or a *manifestation* of his hope?--I can, for example, say it to myself. And surely I am not giving myself a report. It may be a sigh; but it need not. If I tell someone "I can't keep my mind on my work today; I keep on thinking of his coming"--*this* will be called a description of my state of mind.

Page Break 154

Page 154

586. "I have heard he is coming; I have been waiting for him all day." That is a report on how I have spent the day.--In conversation I came to the conclusion that a particular event is to be expected, and I draw this conclusion in the words: "So now I must expect him to come". This may be called the first thought, the first act, of this

expectation.--The exclamation "I'm longing to see him!" may be called an act of expecting. But I can utter the same words as the result of self-observation, and then they might mean: "So, after all that has happened, I am still longing to see him." The point is: what led up to these words?

Page 154

587. Does it make sense to ask "How do you know that you believe?"--and is the answer: "I know it by introspection"?

Page 154

In *some* cases it will be possible to say some such thing, in most not.

Page 154

It makes sense to ask: "Do I really love her, or am I only pretending to myself?" and the process of introspection is the calling up of memories; of imagined possible situations, and of the feelings that one would have if....

Page 154

588. "I am revolving the decision to go away to-morrow." (This may be called a description of a state of mind.)--"Your arguments don't convince me; now as before it is my intention to go away tomorrow." Here one is tempted to call the intention a feeling. The feeling is one of a certain rigidity; of unalterable determination. (But there are many different characteristic feelings and attitudes here.)--I am asked: "How long are you staying here?" I reply: "To-morrow I am going away; it's the end of my holidays."--But over against this: I say at the end of a quarrel "All right! Then I leave to-morrow!"; I make a decision.

Page 154

589. "In my heart I have determined on it." And one is even inclined to point to one's breast as one says it. Psychologically this way of speaking should be taken seriously. Why should it be taken less seriously than the assertion that belief is a state of mind? (Luther: "Faith is under the left nipple.")

Page 154

590. Someone might learn to understand the meaning of the expression "seriously *meaning* what one says" by means of a gesture of pointing at the heart. But now we must ask: "How does it come out that he has learnt it?"

Page Break 155

Page 155

591. Am I to say that any one who has an intention has an experience of tending towards something? That there are particular experiences of 'tending'?--Remember this case: if one urgently wants to make some remark, some objection, in a discussion, it often happens that one opens one's mouth, draws a breath and holds it; if one then decides to let the objection go, one lets the breath out. The experience of this process is evidently the experience of veering towards saying something. Anyone who observes me will know that I wanted to say something and then thought better of it. In *this* situation, that is.--In a different one he would not so interpret my behaviour, however characteristic of the intention to speak it may be in the present situation. And is there any reason for assuming that this same experience could not occur in some quite different situation--in which it has nothing to do with any 'tending'?

Page 155

592. "But when you say 'I intend to go away', you surely mean it! Here again it just is the mental act of meaning that gives the sentence life. If you merely repeat the sentence after someone else, say in order to mock his way of speaking, then you say it without this act of meaning."--When we are doing philosophy it can sometimes look like that. But let us really think out various *different* situations and conversations, and the ways in which that sentence will be uttered in them.--"I always discover a mental undertone; perhaps not always the *same* one." And was there no undertone there when you repeated the sentence after someone else? And how is the 'undertone' to be separated from the rest of the experience of speaking?

Page 155

593. A main cause of philosophical disease--a one-sided diet: one nourishes one's thinking with only one kind of example.

Page 155

594. "But the words, significantly uttered, have after all not only a surface, but also the dimension of depth!" After all, it just is the case that something different takes place when they are uttered significantly from when they are merely uttered.--How I express this is not the point. Whether I say that in the first case they have depth; or that something goes on in me, inside my mind, as I utter them; or that they have an atmosphere--it always comes to the same thing.

Page 155

"Well, if we all agree about it, won't it be true?"

(I cannot accept someone else's testimony, because it is not *testimony*. It only tells me what he is *inclined* to say.)

595. It is natural for us to say a sentence in such-and-such surroundings, and unnatural to say it in isolation. Are we to say that

there is a particular feeling accompanying the utterance of every sentence when we say it naturally?

596. The feeling of 'familiarity' and of 'naturalness'. It is easier to get at a feeling of unfamiliarity and of unnaturalness. Or, at *feelings*. For not everything which is unfamiliar to us makes an impression of unfamiliarity upon us. Here one has to consider what we call "unfamiliar". If a boulder lies on the road, we know it for a boulder, but perhaps not for the one which has always lain there. We recognize a man, say, as a man, but not as an acquaintance. There are feelings of old acquaintance: they are sometimes expressed by a particular way of looking or by the words: "The same old room!" (which I occupied many years before and now returning find unchanged). Equally there are feelings of strangeness. I stop short, look at the object or man questioningly or mistrustfully, say "I find it all strange."--But the existence of this feeling of strangeness does not give us a reason for saying that every object which we know well and which does not seem strange to us gives us a feeling of familiarity.--We think that, as it were, the place once filled by the feeling of strangeness must surely be occupied *somehow*. The place for this kind of atmosphere is there, and if one of them is not in possession of it, then another is.

597. Just as Germanisms creep into the speech of a German who speaks English well although he does not first construct the German expression and then translate it into English; just as this makes him speak English *as if he were translating* 'unconsciously' from the German--so we often think as if our thinking were founded on a thought-schema: as if we were translating from a more primitive mode of thought into ours.

598. When we do philosophy, we should like to hypostatize feelings where there are none. They serve to explain our thoughts to us.

'Here explanation of our thinking demands a feeling!' It is as if our conviction were simply consequent upon this requirement.

599. In philosophy we do not draw conclusions. "But it must be like this!" is not a philosophical proposition. Philosophy only states what everyone admits.

600. Does everything that we do not find conspicuous make an impression of inconspicuousness? Does what is ordinary always make the *impression* of ordinariness?

601. When I talk about this table,--am I *remembering* that this object is called a "table"?

602. Asked "Did you recognize your desk when you entered your room this morning?"--I should no doubt say "Certainly!" And yet it would be misleading to say that an act of recognition had taken place. Of course the desk was not strange to me; I was not surprised to see it, as I should have been if another one had been standing there, or some unfamiliar kind of object.

603. No one will say that every time I enter my room, my long-familiar surroundings, there is enacted a recognition of all that I see and have seen hundreds of times before.

604. It is easy to have a false picture of the processes called "recognizing"; as if recognizing always consisted in comparing two impressions with one another. It is as if I carried a picture of an object with me and used it to perform an identification of an object as the one represented by the picture. Our memory seems to us to be the agent of such a comparison, by preserving a picture of what has been seen before, or by allowing us to look into the past (as if down a spy-glass).

605. And it is not so much as if I were comparing the object with a picture set beside it, but as if the object *coincided* with the picture. So I see only one thing, not two.

Page 157

606. We say "The expression in his voice was *genuine*". If it was spurious we think as it were of another one behind it.--*This* is the face he shews the world, inwardly he has another one.--But this does not mean that when his expression is *genuine* he has two the same.

Page 157

(("A quite particular expression."))

Page 157

607. How does one judge what time it is? I do not mean by external evidences, however, such as the position of the sun, the lightness of the room, and so on.--One asks oneself, say, "What time can it be?", pauses a moment, perhaps imagines a clock-face, and then says a time.--Or one considers various possibilities, thinks first of one time, then of another, and in the end stops at one. That is the kind of way it is done.--But isn't the idea accompanied by a feeling of conviction; and doesn't that mean that it accords with an inner clock?--No, I don't read the time off from any clock; there is a feeling of conviction inasmuch as I say a time to myself *without* feeling any doubt, with calm assurance.--But doesn't something click as I say

Page Break 158

this time?--Not that I know of; unless that is what you call the coming-to-rest of deliberation, the stopping at one number. Nor should I ever have spoken of a 'feeling of conviction' here, but should have said: I considered a while and then plumped for its being quarter past five.--But what did I go by? I might perhaps have said: "simply by feel", which only means that I left it to what should suggest itself.--But you surely must at least have disposed yourself in a definite way in order to guess the time; and you don't take just any idea of a time of day as yielding the correct time!--To repeat: I *asked* myself "I wonder what time it is?" That is, I did not, for example, read this question in some narrative, or quote it as someone else's utterance; nor was I practising the pronunciation of these words; and so on. *These* were not the circumstances of my saying the words.--But then, *what* were the circumstances?--I was thinking about my breakfast and wondering whether it would be late today. These were the kind of circumstances.--But do you really not see that you were all the same disposed in a way which, though impalpable, is characteristic of guessing the time, like being surrounded by a characteristic atmosphere?--Yes; what was characteristic was that I said to myself "I wonder what time it is?"--And if this sentence has a particular atmosphere, how am I to separate it from the sentence itself? It would never have occurred to me to think the sentence had such an aura if I had not thought of how one might say it differently--as a quotation, as a joke, as practice in elocution, and so on. And *then* all at once I wanted to say, then all at once it seemed to me, that I must after all have *meant* the words somehow specially; differently, that is, from in those other cases. The picture of the special atmosphere forced itself upon me; I can see it quite clear before me--so long, that is, as I do not look at what my memory tells me really happened.

Page 158

And as for the feeling of certainty: I sometimes say to myself "I am sure it's o'clock", and in a more or less confident tone of voice, and so on. If you ask me the *reason* for this certainty I have none.

Page 158

If I say, I read it off from an inner clock,--that is a picture, and the only thing that corresponds to it is that I said it was such-and-such a time. And the purpose of the picture is to assimilate this case to the other one. I am refusing to acknowledge two different cases here.

Page 158

608. The idea of the intangibility of that mental state in estimating the time is of the greatest importance. Why is it *intangible*? Isn't it

Page Break 159

because we refuse to count what is tangible about our state as part of the specific state which we are postulating?

Page 159

609. The description of an atmosphere is a special application of language, for special purposes.

Page 159

((Interpreting 'understanding' as atmosphere; as a mental act. One can construct an atmosphere to attach to anything. 'An indescribable character.'))

Page 159

610. Describe the aroma of coffee.--Why can't it be done? Do we lack the words? And *for what* are words lacking?--But how do we get the idea that such a description must after all be possible? Have you ever felt the lack of

such a description? Have you tried to describe the aroma and not succeeded?

Page 159

((I should like to say: "These notes say something glorious, but I do not know what." These notes are a powerful gesture, but I cannot put anything side by side with it that will serve as an explanation. A grave nod. James: "Our vocabulary is inadequate." Then why don't we introduce a new one? What would have to be the case for us to be able to?))

Page 159

611. "Willing too is merely an experience," one would like to say (the 'will' too only 'idea'). It comes when it comes, and I cannot bring it about.

Page 159

Not bring it about?--Like *what*? What can I bring about, then? What am I comparing willing with when I say this?

Page 159

612. I should not say of the movement of my arm, for example: it comes when it comes, etc.. And this is the region in which we say significantly that a thing doesn't simply happen to us, but that we *do* it. "I don't need to wait for my arm to go up--I can raise it." And here I am making a contrast between the movement of my arm and, say, the fact that the violent thudding of my heart will subside.

Page 159

613. In the sense in which I can ever bring anything about (such as stomach-ache through over-eating), I can also bring about an act of willing. In this sense I bring about the act of willing to swim by jumping into the water. Doubtless I was trying to say: I can't will willing; that is, it makes no sense to speak of willing willing. "Willing" is not the name of an action; and so not the name of any voluntary action either. And my use of a wrong expression came from our wanting to think of willing as an immediate non-causal bringing-about. A misleading analogy lies at the root of this idea; the causal

Page Break 160

nexus seems to be established by a mechanism connecting two parts of a machine. The connexion may be broken if the mechanism is disturbed. (We think only of the disturbances to which a mechanism is normally subject, not, say, of cog-wheels suddenly going soft, or passing through one another, and so on.)

Page 160

614. When I raise my arm 'voluntarily' I do not use any instrument to bring the movement about. My wish is not such an instrument either.

Page 160

615. "Willing, if it is not to be a sort of wishing, must be the action itself. It cannot be allowed to stop anywhere short of the action." If it is the action, then it is so in the ordinary sense of the word; so it is speaking, writing, walking, lifting a thing, imagining something. But it is also trying, attempting, making an effort,--to speak, to write, to lift a thing, to imagine something etc..

Page 160

616. When I raise my arm, I have *not* wished it might go up. The voluntary action excludes this wish. It is indeed possible to say: "I hope I shall draw the circle faultlessly". And that is to express a wish that one's hand should move in such-and-such a way.

Page 160

617. If we cross our fingers in a certain special way we are sometimes unable to move a particular finger when someone tells us to do so, if he only *points* to the finger--merely shews it to the eye. If on the other hand he touches it, we can move it. One would like to describe this experience as follows: we are unable to *will* to move the finger. The case is quite different from that in which we are not able to move the finger because someone is, say, holding it. One now feels inclined to describe the former case by saying: one can't find any point of application for the will till the finger is touched. Only when one feels the finger can the will know where it is to catch hold.--But this kind of expression is misleading. One would like to say: "How am I to know where I am to catch hold with the will, if feeling does not shew the place?" But then how is it known to what point I am to direct the will when the feeling is there?

Page 160

That in this case the finger is as it were paralysed until we feel a touch on it is shewn by experience; it could not have been seen *a priori*.

Page 160

618. One imagines the willing subject here as something without any mass (without any inertia); as a motor which has no inertia in itself to overcome. And so it is only mover, not moved. That is:

One can say "I will, but my body does not obey me"--but not: "My will does not obey me." (Augustine.)

Page 161

But in the sense in which I cannot fail to will, I cannot try to will either.

Page 161

619. And one might say: "I can always will only inasmuch as I can never try to will."

Page 161

620. *Doing* itself seems not to have any volume of experience. It seems like an extensionless point, the point of a needle. This point seems to be the real agent. And the phenomenal happenings only to be consequences of this acting. "I *do*..." seems to have a definite sense, separate from all experience.

Page 161

621. Let us not forget this: when 'I raise my arm', my arm goes up. And the problem arises: what is left over if I subtract the fact that my arm goes up from the fact that I raise my arm?

Page 161

((Are the kinaesthetic sensations my willing?))

Page 161

622. When I raise my arm I do not usually *try* to raise it.

Page 161

623. "At all costs I will get to that house."--But if there is no difficulty about it--*can* I try at all costs to get to the house?

Page 161

624. In the laboratory, when subjected to an electric current, for example, someone says with his eyes shut "I am moving my arm up and down"--though his arm is not moving. "So," we say, "he has the special feeling of making that movement."--Move your arm to and fro with your eyes shut. And now try, while you do so, to tell yourself that your arm is staying still and that you are only having certain queer feelings in your muscles and joints!

Page 161

625. "How do you know that you have raised your arm?"--"I feel it." So what you recognize is the feeling? And are you certain that you recognize it right?--You are certain that you have raised your arm; isn't this the criterion, the measure, of the recognition?

Page 161

626. "When I touch this object with a stick I have the sensation of touching in the tip of the stick, not in the hand that holds it." When someone says "The pain isn't here in my hand, but in my wrist", this has the consequence that the doctor examines the wrist. But what difference does it make if I say that I feel the hardness of the

object in the tip of the stick or in my hand? Does what I say mean "It is as if I had nerve-endings in the tip of the stick?" *In what sense* is it like that?--Well, I am at any rate inclined to say "I feel the hardness etc. in the tip of the stick." What goes with this is that when I touch the object I look not at my hand but at the tip of the stick; that I describe what I feel by saying "I feel something hard and round there"--not "I feel a pressure against the tips of my thumb, middle finger, and index finger...." If, for example, someone asks me "What are you now feeling in the fingers that hold the probe?" I might reply: "I don't know--I feel something hard and rough *over there*."

Page 162

627. Examine the following description of a voluntary action: "I form the decision to pull the bell at 5 o'clock, and when it strikes 5, my arm makes this movement."--Is that the correct description, and not *this* one: "..... and when it strikes 5, I raise my arm"?--One would like to supplement the first description: "and see! my arm goes up when it strikes 5." And this "and see!" is precisely what doesn't belong here. I do *not* say "See, my arm is going up!" when I raise it.

Page 162

628. So one might say: voluntary movement is marked by the absence of surprise. And now I do not mean you to ask "But *why* isn't one surprised here?"

Page 162

629. When people talk about the possibility of foreknowledge of the future they always forget the fact of the prediction of one's own voluntary movements.

Page 162

630. Examine these two language-games:

Page 162

(a) Someone gives someone else the order to make particular movements with his arm, or to assume particular bodily positions (gymnastics instructor and pupil). And here is a variation of this language-game: the pupil gives himself orders and then carries them out.

Page 162

(b) Someone observes certain regular processes--for example, the reactions of different metals to acids--and thereupon makes predictions about the reactions that will occur in certain particular cases.

Page 162

There is an evident kinship between these two language-games, and also a fundamental difference. In both one might call the spoken words "predictions". But compare the training which leads to the first technique with the training for the second one.

Page Break 163

Page 163

631. "I am going to take two powders now, and in half-an-hour I shall be sick."--It explains nothing to say that in the first case I am the agent, in the second merely the observer. Or that in the first case I see the causal connexion from inside, in the second from outside. And much else to the same effect.

Page 163

Nor is it to the point to say that a prediction of the first kind is no more infallible than one of the second kind.

Page 163

It was not on the ground of observations of my behaviour that I said I was going to take two powders. The antecedents of this proposition were different. I mean the thoughts, actions and so on which led up to it. And it can only mislead you to say: "The only essential presupposition of your utterance was just your decision."

Page 163

632. I do not want to say that in the case of the expression of intention "I am going to take two powders" the prediction is a cause--and its fulfilment the effect. (Perhaps a physiological investigation could determine this.) So much, however, is true: we can often predict a man's actions from his expression of a decision. An important language-game.

Page 163

633. "You were interrupted a while ago; do you still know what you were going to say?"--If I do know now, and say it--does that mean that I had already thought it before, only not said it? No. Unless you take the certainty with which I continue the interrupted sentence as a criterion of the thought's already having been completed at that time.--But, of course, the situation and the thoughts which I had contained all sorts of things to help the continuation of the sentence.

Page 163

634. When I continue the interrupted sentence and say that this was how I had been going to continue it, this is like following out a line of thought from brief notes.

Page 163

Then don't I *interpret* the notes? Was only one continuation possible in these circumstances? Of course not. But I did not *choose* between interpretations. I *remembered* that I was going to say this.

Page 163

635. "I was going to say....."--You remember various details. But not even all of them together shew your intention. It is as if a snapshot of a scene had been taken, but only a few scattered details of it were to be seen: here a hand, there a bit of a face, or a hat--the rest is dark. And now it is as if we knew quite certainly what the whole picture represented. As if I could read the darkness.

Page Break 164

Page 164

636. These 'details' are not irrelevant in the sense in which other circumstances which I can remember equally well are irrelevant. But if I tell someone "For a moment I was going to say...." he does not learn those details from this, nor need he guess them. He need not know, for instance, that I had already opened my mouth to speak. But he *can* 'fill out the picture' in this way. (And this capacity is part of understanding what I tell him.)

Page 164

637. "I know exactly what I was going to say!" And yet I did not say it.--And yet I don't read it off from some other process which took place then and which I remember.

Page 164

Nor am I *interpreting* that situation and its antecedents. For I don't consider them and don't judge them.

Page 164

638. How does it come about that in spite of this I am inclined to see an interpretation in saying "For a moment I was going to deceive him"?

Page 164

"How can you be certain that for the space of a moment you were going to deceive him? Weren't your actions and thoughts much too rudimentary?"

Page 164

For can't the evidence be too scanty? Yes, when one follows it up it seems extraordinarily scanty; but isn't this because one is taking no account of the history of this evidence? Certain antecedents were necessary for me to have had a momentary intention of pretending to someone else that I was unwell.

Page 164

If someone says "For a moment....." is he really only describing a momentary process?

Page 164

But not even the whole story was my evidence for saying "For a moment....."

Page 164

639. One would like to say that an opinion *develops*. But there is a mistake in this too.

Page 164

640. "This thought ties on to thoughts which I have had before."--How does it do so? Through a *feeling* of such a tie? But how can a feeling really tie thoughts together?--The word "feeling" is very misleading here. But it is sometimes possible to say with certainty: "This thought is connected with those earlier thoughts", and yet be unable to shew the connexion. Perhaps that comes later.

Page 164

641. "My intention was no less certain as it was than it would have been if I had said 'Now I'll deceive him'."--But if you had said the words, would you necessarily have meant them quite seriously? (Thus

Page Break 165

the most explicit expression of intention is by itself insufficient evidence of intention.)

Page 165

642. "At that moment I hated him."--What happened here? Didn't it consist in thoughts, feelings, and actions? And if I were to rehearse that moment to myself I should assume a particular expression, think of certain happenings, breathe in a particular way, arouse certain feelings in myself. I might think up a conversation, a whole scene in which that hatred flared up. And I might play this scene through with feelings approximating to those of a real occasion. That I have actually experienced something of the sort will naturally help me to do so.

Page 165

643. If I now become ashamed of this incident, I am ashamed of the whole thing: of the words, of the poisonous tone, etc..

Page 165

644. "I am not ashamed of what I did then, but of the intention which I had."--And didn't the intention lie *also* in what I did? What justifies the shame? The whole history of the incident.

Page 165

645. "For a moment I meant to...." That is, I had a particular feeling, an inner experience; and I remember it.--And now remember *quite precisely!* Then the 'inner experience' of intending seems to vanish again. Instead one remembers thoughts, feelings, movements, and also connexions with earlier situations.

Page 165

It is as if one had altered the adjustment of a microscope. One did not see before what is now in focus.

Page 165

646. "Well, that only shews that you have adjusted your microscope wrong. You were supposed to look at a particular section of the culture, and you are seeing a different one."

Page 165

There is something right about that. But suppose that (with a particular adjustment of the lenses) I did remember a *single* sensation; how have I the right to say that it is what I call the "intention"? It might be that (for example) a particular tickle accompanied every one of my intentions.

Page 165

647. What is the natural expression of an intention?--Look at a cat when it stalks a bird; or a beast when it wants to escape.

Page 165

((Connexion with propositions about sensations.))

Page 165

648. "I no longer remember the words I used, but I remember my intention precisely; I meant my words to quiet him." What does my memory *shew* me; what does it bring before my mind? Suppose it did

Page Break 166

nothing but suggest those words to me!--and perhaps others which fill out the picture still more exactly.--("I don't remember my words any more, but I certainly remember their spirit.")

Page 166

649. "So if a man has not learned a language, is he unable to have certain memories?" Of course--he cannot have verbal memories, verbal wishes or fears, and so on. And memories etc., in language, are not mere threadbare representations of the *real* experiences; for is what is linguistic not an experience?

Page 166

650. We say a dog is afraid his master will beat him; but not, he is afraid his master will beat him to-morrow. Why not?

Page 166

651. "I remember that I should have been glad then to stay still longer."--What picture of this wish came before my mind? None at all. What I see in my memory allows no conclusion as to my feelings. And yet I remember quite clearly that they were there.

Page 166

652. "He measured him with a hostile glance and said...." The reader of the narrative understands this; he has no doubt in his mind. Now you say: "Very well, he supplies the meaning, he guesses it."--Generally speaking; no. Generally speaking he supplies nothing, guesses nothing.--But it is also possible that the hostile glance and the words later prove to have been pretence, or that the reader is kept in doubt whether they are so or not, and so that he really does guess at a possible interpretation.--But then the main thing he guesses at is a context. He says to himself for example: The two men who are here so hostile to one another are in reality friends, etc. etc.

Page 166

((("If you want to understand a sentence, you have to imagine the psychical significance, the states of mind involved."))

Page 166

653. Imagine this case: I tell someone that I walked a certain route, going by a map which I had prepared beforehand. Thereupon I shew him the map, and it consists of lines on a piece of paper; but I cannot explain how these lines are the map of my movements, I cannot tell him any rule for interpreting the map. Yet I did follow the drawing with all the characteristic tokens of reading a map. I might call such a drawing a 'private' map; or the phenomenon that I have described "following a private map". (But this expression would, of course, be very easy to misunderstand.)

Page 166

Could I now say: "I read off my having then meant to do such-and-such,

Page Break 167

as if from a map, although there is no map"? But that means nothing but: *I am now inclined to say* "I read the intention of acting thus in certain states of mind which I remember."

Page 167

654. Our mistake is to look for an explanation where we ought to look at what happens as a 'proto-phenomenon'. That is, where we ought to have said: *this language-game is played*.

Page 167

655. The question is not one of explaining a language-game by means of our experiences, but of noting a language-game.

Page 167

656. What is the purpose of telling someone that a time ago I had such-and-such a wish?--Look on the language-game as the *primary* thing. And look on the feelings, etc., as you look on a way of regarding the language-game, as interpretation.

Page 167

It might be asked: how did human beings ever come to make the verbal utterances which we call reports of past wishes or past intentions?

Page 167

657. Let us imagine these utterances always taking this form: "I said to myself: 'if only I could stay longer!'" The purpose of such a statement might be to acquaint someone with my reactions. (Compare the grammar of "mean" and "vouloir dire".)

658. Suppose we expressed the fact that a man had an intention by saying "He as it were said to himself 'I will....'"--That is the picture. And now I want to know: how does one employ the expression "as it were to say something to oneself"? For it does not mean: to say something to oneself.

659. Why do I want to tell him about an intention too, as well as telling him what I did?--Not because the intention was also something which was going on at that time. But because I want to tell him something about *myself*, which goes beyond what happened at that time.

I reveal to him something of myself when I tell him what I was going to do.--Not, however, on grounds of self-observation, but by way of a response (it might also be called an intuition).

660. The grammar of the expression "I was then going to say...." is related to that of the expression "I could then have gone on."

In the one case I remember an intention, in the other I remember having understood.

661. I remember having meant *him*. Am I remembering a process or state?--When did it begin, what was its course; etc.?

662. In an only slightly different situation, instead of silently beckoning, he would have said to someone "Tell N. to come to me." One can now say that the words "I wanted N. to come to me" describe the state of my mind at that time; and again one may *not* say so.

663. If I say "I meant *him*" very likely a picture comes to my mind, perhaps of how I looked at him, etc.; but the picture is only like an illustration to a story. From it alone it would mostly be impossible to conclude anything at all; only when one knows the story does one know the significance of the picture.

664. In the use of words one might distinguish 'surface grammar' from 'depth grammar'. What immediately impresses itself upon us about the use of a word is the way it is used in the construction of the sentence, the part of its use--one might say--that can be taken in by the ear.--And now compare the depth grammar, say of the word "to mean", with what its surface grammar would lead us to suspect. No wonder we find it difficult to know our way about.

665. Imagine someone pointing to his cheek with an expression of pain and saying "abracadabra!"--We ask "What do you mean?" And he answers "I meant toothache".--You at once think to yourself: How can one 'mean toothache' by that word? Or what did it *mean to mean* pain by that word? And yet, in a different context, you would have asserted that the mental activity of *meaning* such-and-such was just what was most important in using language.

But--can't I say "By 'abracadabra' I mean toothache"? Of course I can; but this is a definition; not a description of what goes on in me when I utter the word.

666. Imagine that you were in pain and were simultaneously hearing a nearby piano being tuned. You say "It'll soon stop." It certainly makes quite a difference whether you mean the pain or the piano-tuning!--Of course; but what does this difference consist in? I admit, in many cases some direction of the attention will correspond to your meaning one thing or another, just as a look often does, or a gesture, or a way of shutting one's eyes which might be called "looking into oneself".

667. Imagine someone simulating pain, and then saying "It'll get better soon". Can't one say he means the pain? and yet he is not concentrating his attention on any pain.--And what about when I finally say "It's stopped now"?

668. But can't one also lie in this way: one says "It'll stop soon", and means pain--but when asked "What did you mean?" one answers "The noise in the next room"? In this sort of case one may say: "I was going to answer.... but thought better of it and did answer....."

Page 169

669. One can refer to an object when speaking by pointing to it. Here pointing is a part of the language-game. And now it seems to us as if one spoke *of* a sensation by directing one's attention to it. But where is the analogy? It evidently lies in the fact that one can point to a thing by *looking* or *listening*.

Page 169

But in certain circumstances, even *pointing* to the object one is talking about may be quite inessential to the language-game, to one's thought.

Page 169

670. Imagine that you were telephoning someone and you said to him: "This table is too tall", and pointed to the table. What is the role of pointing here? Can I say: I *mean* the table in question by pointing to it? What is this pointing for, and what are these words and whatever else may accompany them for?

Page 169

671. And what do I point to by the inner activity of listening? To the sound that comes to my ears, and to the silence when I hear *nothing*?

Page 169

Listening as it were *looks for* an auditory impression and hence can't point to it, but only to the *place* where it is looking for it.

Page 169

672. If a receptive attitude is called a kind of 'pointing' to something--then that something is not the sensation which we get by means of it.

Page 169

673. The mental attitude doesn't '*accompany*' what is said in the sense in which a gesture accompanies it. (As a man can travel alone, and yet be accompanied by my good wishes; or as a room can be empty, and yet full of light.)

Page 169

674. Does one say, for example: "I didn't really mean my pain just now; my mind wasn't on it enough for that?" Do I ask myself, say: "What did I mean by this word just now? My attention was divided between my pain and the noise--"?

Page Break 170

Page 170

675. "Tell me, what was going on in you when you uttered the words....?"--The answer to this is not: "I was meaning....."!

Page 170

676. "I meant *this* by that word" is a statement which is differently used from one about an affection of the mind.

Page 170

677. On the other hand: "When you were swearing just now, did you really mean it?" This is perhaps as much as to say: "Were you really angry?"--And the answer may be given as a result of introspection and is often some such thing as: "I didn't mean it very seriously", "I meant it half jokingly" and so on. There are differences of degree here.

Page 170

And one does indeed also say "I was half thinking of him when I said that."

Page 170

678. What does this act of meaning (the pain, or the piano-tuning) consist in? No answer comes--for the answers which at first sight suggest themselves are of no use.--"And yet at the time I *meant* the one thing and not the other." Yes,--now you have only repeated with emphasis something which no one has contradicted anyway.

Page 170

679. "But can you doubt that you meant *this*?"--No; but neither can I be certain of it, know it.

Page 170

680. When you tell me that you cursed and meant N. as you did so it is all one to me whether you looked at a picture of him, or imagined him, uttered his name, or what. The conclusions from this fact that interest me have nothing to do with these things. On the other hand, however, someone might explain to me that cursing was *effective* only when one had a clear image of the man or spoke his name out loud. But we should not say "The point

is how the man who is cursing *means* his victim."

Page 170

681. Nor, of course, does one ask: "Are you sure that you cursed *him*, that the connexion with him was established?"

Page 170

Then this connexion must be very easy to establish, if one can be so sure of it?! Can know that it doesn't fail of its object!--Well, can it happen to me, to intend to write to one person and in fact write to another? and how might it happen?

Page 170

682. "You said, 'It'll stop soon'.--Were you thinking of the noise or of your pain?" If he answers "I was thinking of the piano-tuning"--is he observing that the connexion existed, or is he making it by means

Page Break 171

of these words?--Can't I say *both*? If what he said was true, didn't the connexion exist--and is he not for all that making one which did not exist?

Page 171

683. I draw a head. You ask "Whom is that supposed to represent?"--I: "It's supposed to be N."--You: "But it doesn't look like him; if anything, it's rather like M."--When I said it represented N.--was I establishing a connexion or reporting one? And what connexion did exist?

Page 171

684. What is there in favour of saying that my words describe an existing connexion? Well, they relate to various things which didn't simply make their appearance with the words. They say, for example, that I *should have* given a particular answer then, if I had been asked.

Page 171

And even if this is only conditional, still it does say something about the past.

Page 171

685. "Look for A" does not mean "Look for B"; but I may do just the same thing in obeying the two orders.

Page 171

To say that something different must happen in the two cases would be like saying that the propositions "Today is my birthday" and "My birthday is on April 26th" must refer to different days, because they do not make the same sense.

Page 171

686. "Of course I meant B; I didn't think of A at all!"

Page 171

"I wanted B to come to me, so as to..."--All this points to a wider context.

Page 171

687. Instead of "I meant him" one can, of course, sometimes say "I thought of him"; sometimes even "Yes, we were speaking of him." Ask yourself what 'speaking of him' consists in.

Page 171

688. In certain circumstances one can say "As I was speaking, I felt I was saying it *to you*". But I should not say this if I were in any case talking with you.

Page 171

689. "I am thinking of N." "I am speaking of N."

Page 171

How do I speak *of* him? I say, for instance, "I must go and see N today"--But surely that is not enough! After all, when I say "N" I might mean various people of this name.--"Then there must surely be a further, different connexion between my talk and N, for otherwise I should *still* not have meant HIM.

Page 171

Certainly such a connexion exists. Only not as you imagine it: namely by means of a mental *mechanism*.

Page 171

(One compares "meaning him" with "aiming at him".)

Page Break 172

Page 172

690. What about the case where I at one time make an apparently innocent remark and accompany it with a furtive sidelong glance at someone; and at another time, without any such glance, speak of somebody present openly, mentioning his name--am I really thinking *specially* about him as I use his name?

691. When I make myself a sketch of N's face from memory, I can surely be said to *mean* him by my drawing. But which of the processes taking place while I draw (or before or afterwards) could I call meaning him?

For one would naturally like to say: when he meant him, he aimed at him. But how is anyone doing that, when he calls someone else's face to mind?

I mean, how does he call HIM to mind?

How does he call him?

692. Is it correct for someone to say: "When I gave you this rule, I meant you to..... in this case"? Even if he did not think of this case at all as he gave the rule? Of course it is correct. For "to mean it" did not mean: to think of it. But now the problem is: how are we to judge whether someone meant such-and-such?--The fact that he has, for example, mastered a particular technique in arithmetic and algebra, and that he taught someone else the expansion of a series in the usual way, is such a criterion.

693. "When I teach someone the formation of the series.... I surely mean him to write.... at the hundredth place."--Quite right; you mean it. And evidently without necessarily even thinking of it. This shews you how different the grammar of the verb "to mean" is from that of "to think". And nothing is more wrong-headed than calling meaning a mental activity! Unless, that is, one is setting out to produce confusion. (It would also be possible to speak of an activity of butter when it rises in price, and if no problems are produced by this it is harmless.)

PART II

i

One can imagine an animal angry, frightened, unhappy, happy, startled. But hopeful? And why not?

A dog believes his master is at the door. But can he also believe his master will come the day after to-morrow?--And *what* can he not do here?--How do I do it?--How am I supposed to answer this?

Can only those hope who can talk? Only those who have mastered the use of a language. That is to say, the phenomena of hope are modes of this complicated form of life. (If a concept refers to a character of human handwriting, it has no application to beings that do not write.)

"Grief" describes a pattern which recurs, with different variations, in the weave of our life. If a man's bodily expression of sorrow and of joy alternated, say with the ticking of a clock, here we should not have the characteristic formation of the pattern of sorrow or of the pattern of joy.

"For a second he felt violent pain."--Why does it sound queer to say: "For a second he felt deep grief"? Only because it so seldom happens?

But don't you feel grief *now*? ("But aren't you playing chess *now*?" The answer may be affirmative, but that does not make the concept of grief any more like the concept of a sensation.--The question was really, of course, a temporal and personal one, not the logical question which we wanted to raise.

"I must tell you: I am frightened."

"I must tell you: it makes me shiver."--

And one can say this in a *smiling* tone of voice too.

And do you mean to tell me he doesn't feel it? How else does he *know* it?--But even when he says it as a

piece of information he does not learn it from his sensations.

Page 174

For think of the sensations produced by physically shuddering: the words "it makes me shiver" are themselves such a shuddering reaction; and if I hear and feel them as I utter them, this belongs among the rest of those sensations. Now why should the wordless shudder be the ground of the verbal one?

Page Break 175

ii

Page 175

In saying "When I heard this word, it meant.... to me" one refers to a *point of time* and to a *way of using the word*. (Of course, it is this combination that we fail to grasp.)

Page 175

And the expression "I was then going to say....." refers to a *point of time* and to an *action*.

Page 175

I speak of the essential *references* of the utterance in order to distinguish them from other peculiarities of the expression we use. The references that are essential to an utterance are the ones which would make us translate some otherwise alien form of expression into this, our customary form.

Page 175

If you were unable to say that the word "till" could be both a verb and a conjunction, or to construct sentences in which it was now the one and now the other, you would not be able to manage simple schoolroom exercises. But a schoolboy is not asked to *conceive* the word in one way or another out of any context, or to report how he has conceived it.

Page 175

The words "the rose is red" are meaningless if the word "is" has the meaning "is identical with".--Does this mean: if you say this sentence and mean the "is" as the sign of identity, the sense disintegrates?

Page 175

We take a sentence and tell someone the meaning of each of its words; this tells him how to apply them and so how to apply the sentence too. If we had chosen a senseless sequence of words instead of the sentence, he would not learn how to apply the *sequence*. And if we explain the word "is" as the sign of identity, then he does not learn how to use the sentence "the rose is red".

Page 175

And yet there is something right about this 'disintegration of the sense'. You get it in the following example: one might tell someone: if you want to pronounce the salutation "Hail!" expressively, you had better not think of hailstones as you say it.

Page 175

Experiencing a meaning and experiencing a mental image. "In both cases", we should like to say, "we are *experiencing* something, only something different. A different content is proffered--is present--to consciousness."--What is the content of the experience of imagining? The answer is a picture, or a description. And what is the content

Page Break 176

of the experience of meaning? I don't know what I am supposed to say to this.--If there is any sense in the above remark, it is that the two concepts are related like those of 'red' and 'blue'; and that is wrong.

Page 176

Can one keep hold of an understanding of meaning as one can keep hold of a mental image? That is, if one meaning of a word suddenly strikes me,--can it also stay there in my mind?

Page 176

"The whole scheme presented itself to my mind in a flash and stayed there like that for five minutes." Why does this sound odd? One would like to think: what flashed on me and what stayed there in my mind can't have been the same.

Page 176

I exclaimed "Now I have it!"--a sudden start, and then I was able to set the scheme forth in detail. What is supposed to have stayed in this case? A picture, perhaps. But "Now I have it" did not mean, I have the picture.

Page 176

If a meaning of a word has occurred to you and you have not *forgotten* it again, you can now use the word in such-and-such a way.

Page 176

If the meaning has occurred to you, now you *know* it, and the knowing began when it occurred to you. Then how is it like an experience of imagining something?

Page 176

If I say "Mr. Scot is not a Scot", I mean the first "Scot" as a proper name, the second one as a common name. Then do different things have to go on in my mind at the first and second "Scot"? (Assuming that I am not uttering the sentence 'parrot-wise'.)--Try to mean the first "Scot" as a common name and the second one as a proper name.--How is it done? When *I* do it, I blink with the effort as I try to parade the right meanings before my mind in saying the words.--But do I parade the meanings of the words before my mind when I make the ordinary use of them?

Page 176

When I say the sentence with this exchange of meanings I feel that its sense disintegrates.--Well, *I* feel it, but the person I am saying it to does not. So what harm is done?--"But the point is, when one utters the sentence in the usual way something *else*, quite definite, takes place."--What takes place is *not* this 'parade of the meanings before one's mind'.

Page Break 177

iii

Page 177

What makes my image of him into an image of *him*?

Page 177

Not its looking like him.

Page 177

The same question applies to the expression "I see him now vividly before me" as to the image. What makes this utterance into an utterance about *him*?--Nothing in it or simultaneous with it ('behind it'). If you want to know whom he meant, ask him.

Page 177

(But it is also possible for a face to come before my mind, and even for me to be able to draw it, without my knowing whose it is or where I have seen it.)

Page 177

Suppose, however, that someone were to draw while he had an image or instead of having it, though it were only with his finger in the air. (This might be called "motor imagery.") He could be asked: "Whom does that represent?" And his answer would be decisive.--It is quite as if he had given a verbal description: and such a description can also simply take the *place* of the image.

Page Break 178

iv

Page 178

"I believe that he is suffering."--Do I also *believe* that he isn't an automaton?

Page 178

It would go against the grain to use the word in both connexions.

Page 178

(Or is it like this: I believe that he is suffering, but am certain that he is not an automaton? Nonsense!)

Page 178

Suppose I say of a friend: "He isn't an automaton".--What information is conveyed by this, and to whom would it be information? To a *human being* who meets him in ordinary circumstances? What information *could* it give him? (At the very most that this man always behaves like a human being, and not occasionally like a machine.)

Page 178

"I believe that he is not an automaton", just like that, so far makes no sense.

Page 178

My attitude towards him is an attitude towards a soul. I am not of the *opinion* that he has a soul.

Page 178

Religion teaches that the soul can exist when the body has disintegrated. Now do I understand this teaching?--Of course I understand it--I can imagine plenty of things in connexion with it. And haven't pictures of these things been painted? And why should such a picture be only an imperfect rendering of the spoken doctrine? Why should it not do the *same* service as the words? And it is the service which is the point.

Page 178

If the picture of thought in the head can force itself upon us, then why not much more that of thought in the

soul?

Page 178

The human body is the best picture of the human soul.

Page 178

And how about such an expression as: "In my heart I understood when you said that", pointing to one's heart? Does one, perhaps, not *mean* this gesture? Of course one means it. Or is one conscious of using a *mere* figure? Indeed not.--It is not a figure that we choose, not a simile, yet it is a figurative expression.

Page Break 179

V

Page 179

Suppose we were observing the movement of a point (for example, a point of light on a screen). It might be possible to draw important consequences of the most various kinds from the behaviour of this point. And what a variety of observations can be made here!--The path of the point and certain of its characteristic measures (amplitude and wave-length for instance), or the velocity and the law according to which it varies, or the number or position of the places at which it changes discontinuously, or the curvature of the path at these places, and innumerable other things.--Any of these features of its behaviour might be the only one to interest us. We might, for example, be indifferent to everything about its movements except for the number of loops it made in a certain time.--And if we were interested, not in just *one* such feature, but in several, each might yield us special information, different in kind from all the rest. This is how it is with the behaviour of man; with the different characteristic features which we observe in this behaviour.

Page 179

Then psychology treats of behaviour, not of the mind?

Page 179

What do psychologists record?--What do they observe? Isn't it the behaviour of human beings, in particular their utterances? But *these* are not about behaviour.

Page 179

"I noticed that he was out of humour." Is this a report about his behaviour or his state of mind? ("The sky looks threatening": is this about the present or the future?) Both; not side-by-side, however, but about the one *via* the other.

Page 179

A doctor asks: "How is he feeling?" The nurse says: "He is groaning". A report on his behaviour. But need there be any question for them whether the groaning is really genuine, is really the expression of anything? Might they not, for example, draw the conclusion "If he groans, we must give him more analgesic"--without suppressing a middle term? Isn't the point the service to which they put the description of behaviour?

Page 179

"But then they make a tacit presupposition." Then what we do in our language-game always rests on a tacit presupposition.

Page Break 180

Page 180

I describe a psychological experiment: the apparatus, the questions of the experimenter, the actions and replies of the subject--and then I say that it is a scene in a play.--Now everything is different. So it will be said: If this experiment were described in the same way in a book on psychology, then the behaviour described would be understood as the expression of something mental just because it is *presupposed* that the subject is not taking us in, hasn't learnt the replies by heart, and other things of the kind.--So we are making a presupposition?

Page 180

Should we ever really express ourselves like this: "Naturally I am presupposing that....."?--Or do we not do so only because the other person already knows that?

Page 180

Doesn't a presupposition imply a doubt? And doubt may be entirely lacking. Doubting has an end.

Page 180

It is like the relation: physical object--sense-impressions. Here we have two different language-games and a complicated relation between them.--If you try to reduce their relations to a *simple* formula you go wrong.

Page Break 181

Suppose someone said: every familiar word, in a book for example, actually carries an atmosphere with it in our minds, a 'corona' of lightly indicated uses.--Just as if each figure in a painting were surrounded by delicate shadowy drawings of scenes, as it were in another dimension, and in them we saw the figures in different contexts.--Only let us take this assumption seriously!--Then we see that it is not adequate to explain *intention*.

For if it is like this, if the possible uses of a word do float before us in half-shades as we say or hear it--this simply goes for *us*. But we communicate with other people without knowing if they have this experience too.

How should we counter someone who told us that with *him* understanding was an inner process?--How should we counter him if he said that with him knowing how to play chess was an inner process?--We should say that when we want to know if he can play chess we aren't interested in anything that goes on inside him.--And if he replies that this is in fact just what we are interested in, that is, we are interested in whether he can play chess--then we shall have to draw his attention to the criteria which would demonstrate his capacity, and on the other hand to the criteria for the 'inner states'.

Even if someone had a particular capacity only when, and only as long as, he had a particular feeling, the feeling would not be the capacity.

The meaning of a word is not the experience one has in hearing or saying it, and the sense of a sentence is not a complex of such experiences.--(How do the meanings of the individual words make up the sense of the sentence "I still haven't seen him yet"?) The sentence is composed of the words, and that is enough.

Though--one would like to say--every word has a different character in different contexts, at the same time there is *one* character it always has: a single physiognomy. It looks at us.--But a face in a *painting* looks at us too.

Are you sure that there is a single if-feeling, and not perhaps several? Have you tried saying the word in a great variety of contexts? For

example, when it bears the principal stress of the sentence, and when the word next to it does.

Suppose we found a man who, speaking of how words felt to him, told us that "if" and "but" felt the *same*.--Should we have the right to disbelieve him? We might think it strange. "He doesn't play our game at all", one would like to say. Or even: "This is a different type of man."

If he *used* the words "if" and "but" as we do, shouldn't we think he understood them as we do?

One misjudges the psychological interest of the if-feeling if one regards it as the obvious correlate of a meaning; it needs rather to be seen in a different context, in that of the special circumstances in which it occurs.

Does a person never have the if-feeling when he is not uttering the word "if"? Surely it is at least remarkable if this cause alone produces this feeling. And this applies generally to the 'atmosphere' of a word;--why does one regard it so much as a matter of course that only *this* word has this atmosphere?

The if-feeling is not a feeling which accompanies the word "if".

The if-feeling would have to be compared with the special 'feeling' which a musical phrase gives us. (One sometimes describes such a feeling by saying "Here it is as if a conclusion were being drawn", or "I should like to say *'hence.....'*", or "Here I should always like to make a gesture--" and then one makes it.)

But can this feeling be separated from the phrase? And yet it is not the phrase itself, for that can be heard without the feeling.

Is it in this respect like the 'expression' with which the phrase is played?

We say this passage gives us a quite special feeling. We sing it to ourselves, and make a certain movement,

and also perhaps have some special sensation. But in a different context we should not recognize these accompaniments--the movement, the sensation--at all. They are quite empty except just when we are singing this passage.

Page Break 183

Page 183

"I sing it with a quite particular expression." This expression is not something that can be separated from the passage. It is a different concept. (A different game.)

Page 183

The experience is this passage played like *this* (that is, as I am doing it, for instance; a description could only *hint* at it).

Page 183

Thus the atmosphere that is inseparable from its object--is not an atmosphere.

Page 183

Closely associated things, things which we *have* associated, seem to fit one another. But what is this seeming to fit? How is their seeming to fit manifested? Perhaps like this: we cannot imagine the man who had this name, this face, this handwriting, not to have produced *these* works, but perhaps quite different ones instead (those of another great man).

Page 183

We cannot imagine it? Do we try?--

Page 183

Here is a possibility: I hear that someone is painting a picture "Beethoven writing the ninth symphony". I could easily imagine the kind of thing such a picture would shew us. But suppose someone wanted to represent what Goethe would have looked like writing the ninth symphony? Here I could imagine nothing that would not be embarrassing and ridiculous.

Page Break 184

vii

Page 184

People who on waking tell us certain incidents (that they have been in such-and-such places, etc.). Then we teach them the expression "I dreamt", which precedes the narrative. Afterwards I sometimes ask them "did you dream anything last night?" and am answered yes or no, sometimes with an account of a dream, sometimes not. That is the language-game. (I have assumed here that I do not dream myself. But then, nor do I ever have the feeling of an invisible presence; other people do, and I can question them about their experiences.)

Page 184

Now must I make some assumption about whether people are deceived by their memories or not; whether they really had these images while they slept, or whether it merely seems so to them on waking? And what meaning has this question?--And what interest? Do we ever ask ourselves this when someone is telling us his dream? And if not--is it because we are sure his memory won't have deceived him? (And suppose it were a man with a quite specially bad memory?--)

Page 184

Does this mean that it is nonsense ever to raise the question whether dreams really take place during sleep, or are a memory phenomenon of the awakened? It will turn on the use of the question.

Page 184

"The mind seems able to give a word meaning"--isn't this as if I were to say "The carbon atoms in benzene seem to lie at the corners of a hexagon"? But this is not something that seems to be so; it is a picture.

Page 184

The evolution of the higher animals and of man, and the awakening of consciousness at a particular level. The picture is something like this: Though the ether is filled with vibrations the world is dark. But one day man opens his seeing eye, and there is light.

Page 184

What this language primarily describes is a picture. What is to be done with the picture, how it is to be used, is still obscure. Quite clearly, however, it must be explored if we want to understand the sense of what we are saying. But the picture seems to spare us this work: it already points to a particular use. This is how it takes us in.

Page Break 185

viii

"My kinaesthetic sensations advise me of the movement and position of my limbs."

I let my index finger make an easy pendulum movement of small amplitude. I either hardly feel it, or don't feel it at all. Perhaps a little in the tip of the finger, as a slight tension. (Not at all in the joint.) And this sensation advises me of the movement?--for I can describe the movement exactly.

"But after all, you must feel it, otherwise you wouldn't know (without looking) how your finger was moving." But "knowing" it only means: being able to describe it.--I may be able to tell the direction from which a sound comes only because it affects one ear more strongly than the other, but I don't feel this in my ears; yet it has its effect: I *know* the direction from which the sound comes; for instance, I look in that direction.

It is the same with the idea that it must be some feature of our pain that advises us of the whereabouts of the pain in the body, and some feature of our memory image that tells us the time to which it belongs.

A sensation *can* advise us of the movement or position of a limb. (For example, if you do not know, as a normal person does, whether your arm is stretched out, you might find out by a piercing pain in the elbow.)--In the same way the character of a pain can tell us where the injury is. (And the yellowness of a photograph how old it is.)

What is the criterion for my learning the shape and colour of an object from a sense-impression?

What sense-impression? Well, *this* one; I use words or a picture to describe it.

And now: what do you feel when your fingers are in this position?--"How is one to define a feeling? It is something special and indefinable." But it must be possible to teach the use of the words!

What I am looking for is the grammatical difference.

Let us leave the kinaesthetic feeling out for the moment.--I want to describe a feeling to someone, and I tell him "Do *this*, and then you'll

get it," and I hold my arm or my head in a particular position. Now is this a description of a feeling? and when shall I say that he has understood what feeling I meant?--He will have to give a *further* description of the feeling afterwards. And what kind of description must it be?

I say "Do *this*, and you'll get it". Can't there be a doubt here? Mustn't there be one, if it is a feeling that is meant?

This looks *so*; *this* tastes *so*; *this* feels *so*. "This" and "so" must be differently explained.

Our interest in a 'feeling' is of a quite *particular* kind. It includes, for instance, the 'degree of the feeling', its 'place', and the extent to which one feeling can be submerged by another. (When a movement is very painful, so that the pain submerges every other slight sensation in the same place, does this make it uncertain whether you have really made this movement? Could it lead you to find out by looking?)

ix

If you observe your own grief, which senses do you use to observe it? A particular sense; one that *feels* grief? Then do you feel it *differently* when you are observing it? And what is the grief that you are observing--is it one which is there only while it is being observed?

'Observing' does not produce what is observed. (That is a conceptual statement.)

Again: I do not 'observe' what only comes into being through observation. The object of observation is something *else*.

Page 187

A touch which was still painful yesterday is no longer so today.

Page 187

Today I feel the pain only when I think about it. (That is: in certain circumstances.)

Page 187

My grief is no longer the same; a memory which was still unbearable to me a year ago is now no longer so.

Page 187

That is a result of observation.

Page 187

When do we say that any one is observing? Roughly: when he puts himself in a favourable position to receive certain impressions in order (for example) to describe what they tell him.

Page 187

If you trained someone to emit a particular sound at the sight of something red, another at the sight of something yellow, and so on for other colours, still he would not yet be describing objects by their colours. Though he might be a help to us in giving a description. A description is a representation of a distribution in a space (in that of time, for instance).

Page 187

If I let my gaze wander round a room and suddenly it lights on an object of a striking red colour, and I say "Red!"--that is not a description.

Page 187

Are the words "I am afraid" a description of a state of mind?

Page 187

I say "I am afraid"; someone else asks me: "What was that? A cry of fear; or do you want to tell me how you feel; or is it a reflection on your present state?"--Could I always give him a clear answer? Could I never give him one?

Page Break 188

Page 188

We can imagine all sorts of things here, for example:

Page 188

"No, no! I am afraid!"

Page 188

"I am afraid. I am sorry to have to confess it."

Page 188

"I am still a bit afraid, but no longer as much as before."

Page 188

"At bottom I am still afraid, though I won't confess it to myself."

Page 188

"I torment myself with all sorts of fears."

Page 188

"Now, just when I should be fearless, I am afraid!"

Page 188

To each of these sentences a special tone of voice is appropriate, and a different context.

Page 188

It would be possible to imagine people who as it were thought much more definitely than we, and used different words where we use only one.

Page 188

We ask "What does 'I am frightened' really mean, what am I referring to when I say it?" And of course we find no answer, or one that is inadequate.

Page 188

The question is: "In what sort of context does it occur?"

Page 188

I can find no answer if I try to settle the question "What am I referring to?" "What am I thinking when I say it?" by repeating the expression of fear and at the same time attending to myself, as it were observing my soul out of the corner of my eye. In a concrete case I can indeed ask "Why did I say that, what did I mean by it?"--and I might answer the question too; but not on the ground of observing what accompanied the speaking. And my answer would supplement, paraphrase, the earlier utterance.

What is fear? What does "being afraid" mean? If I wanted to define it at a *single* shewing--I should *play-act* fear.

Could I also represent hope in this way? Hardly. And what about belief?

Describing my state of mind (of fear, say) is something I do in a particular context. (Just as it takes a particular context to make a certain action into an experiment.)

Is it, then, so surprising that I use the same expression in different games? And sometimes as it were between the games?

And do I always talk with very definite purpose?--And is what I say meaningless because I don't?

When it is said in a funeral oration "We mourn our...." this is surely supposed to be an expression of mourning; not to tell anything to those who are present. But in a prayer at the grave these words would in a way be used to tell someone something.

But here is the problem: a cry, which cannot be called a description, which is more primitive than any description, for all that serves as a description of the inner life.

A cry is not a description. But there are transitions. And the words "I am afraid" may approximate more, or less, to being a cry. They may come quite close to this and also be *far* removed from it.

We surely do not always say someone is *complaining*, because he says he is in pain. So the words "I am in pain" may be a cry of complaint, and may be something else.

But if "I am afraid" is not always something like a cry of complaint and yet sometimes is, then why should it *always* be a description of a state of mind?

X

How did we ever come to use such an expression as "I believe..."? Did we at some time become aware of a phenomenon (of belief)?

Did we observe ourselves and other people and so discover belief?

Moore's paradox can be put like this: the expression "I believe that this is the case" is used like the assertion "This is the case"; and yet the *hypothesis* that I believe this is the case is not used like the hypothesis that this is the case.

So it *looks* as if the assertion "I believe" were not the assertion of what is supposed in the hypothesis "I believe"!

Similarly: the statement "I believe it's going to rain" has a meaning like, that is to say a use like, "It's going to rain", but the meaning of "I believed then that it was going to rain", is not like that of "It did rain then".

"But surely 'I believed' must tell of just the same thing in the past as 'I believe' in the present!"--Surely

$\sqrt{-1}$ must mean just the same in relation to -1, as $\sqrt{1}$ means in relation to 1! This means nothing at all.

"At bottom, when I say 'I believe...' I am describing my own state of mind--but this description is indirectly an assertion of the fact believed."--As in certain circumstances I describe a photograph in order to describe the thing it is a photograph of.

But then I must also be able to say that the photograph is a good one. So here too: "I believe it's raining and my belief is reliable, so I have confidence in it."--In that case my belief would be a kind of sense-impression.

Page 190

One can mistrust one's own senses, but not one's own belief.

Page 190

If there were a verb meaning 'to believe falsely', it would not have any significant first person present indicative.

Page 190

Don't look at it as a matter of course, but as a most remarkable thing, that the verbs "believe", "wish", "will" display all the inflexions possessed by "cut", "chew", "run".

Page 190

The language-game of reporting can be given such a turn that a report is not meant to inform the hearer about its subject matter but about the person making the report.

Page Break 191

Page 191

It is so when, for instance, a teacher examines a pupil. (You can measure to test the ruler.)

Page 191

Suppose I were to introduce some expression--"I believe", for instance--in this way: it is to be prefixed to reports when they serve to give information about the reporter. (So the expression need not carry with it any suggestion of uncertainty. Remember that the uncertainty of an assertion can be expressed impersonally: "He might come today".)--"I believe...., and it isn't so" would be a contradiction.

Page 191

"I believe...." throws light on my state. Conclusions about my conduct can be drawn from this expression. So there is a *similarity* here to expressions of emotion, of mood, etc..

Page 191

If, however, "I believe it is so" throws light on my state, then so does the assertion "It is so". For the sign "I believe" can't do it, can at the most hint at it.

Page 191

Imagine a language in which "I believe it is so" is expressed only by means of the tone of the assertion "It is so". In this language they say, not "He believes" but "He is inclined to say...." and there exists also the hypothetical (subjunctive) "Suppose I were inclined etc.", but not the expression "I am inclined to say".

Page 191

Moore's paradox would not exist in this language; instead of it, however, there would be a verb lacking one inflexion.

Page 191

But this ought not to surprise us. Think of the fact that one can predict one's *own* future action by an expression of intention.

Page 191

I say of someone else "He seems to believe...." and other people say it of me. Now, why do I never say it of myself, not even when others *rightly* say it of me?--Do I myself not see and hear myself, then?--That can be said.

Page 191

"One feels conviction within oneself, one doesn't infer it from one's own words or their tone."--What is true here is: one does not infer one's own conviction from one's own words; nor yet the actions which arise from that conviction.

Page 191

"Here it *looks* as if the assertion 'I believe' were not the assertion of what is supposed in the hypothesis."--So I am tempted to look for a different development of the verb in the first person present indicative.

Page 191

This is how I think of it: Believing is a state of mind. It has duration; and that independently of the duration of its expression in a sentence, for example. So it is a kind of disposition of the believing person. This is shewn me in the case of someone else by his behaviour; and

Page Break 192

by his words. And under this head, by the expression "I believe..." as well as by the simple assertion.--What about my own case: how do I myself recognize my own disposition?--Here it will have been necessary for me to take notice of myself as others do, to listen to myself talking, to be able to draw conclusions from what I say!

Page 192

My own relation to my words is wholly different from other people's.

Page 192

That different development of the verb would have been possible, if only I could say "I seem to believe".

Page 192

If I listened to the words of my mouth, I might say that someone else was speaking out of my mouth.

Page 192

"Judging from what I say, *this* is what I believe." Now, it is possible to think out circumstances in which these words would make sense.

Page 192

And then it would also be possible for someone to say "It is raining and I don't believe it", or "It seems to me that my ego believes this, but it isn't true." One would have to fill out the picture with behaviour indicating that two people were speaking through my mouth.

Page 192

Even in the *hypothesis* the pattern is not what you think.

Page 192

When you say "Suppose I believe...." you are presupposing the whole grammar of the word "to believe", the ordinary use, of which you are master.--You are not supposing some state of affairs which, so to speak, a picture presents unambiguously to you, so that you can tack on to this hypothetical use some assertive use other than the ordinary one.--You would not know at all what you were supposing here (i.e. what, for example, would follow from such a supposition), if you were not already familiar with the use of "believe".

Page 192

Think of the expression "I say....", for example in "I say it will rain today", which simply comes to the same thing as the assertion "It will....". "He says it will...." means approximately "He believes it will....". "Suppose I say...." does *not* mean: Suppose it rains today.

Page 192

Different concepts touch here and coincide over a stretch. But you need not think that all lines are *circles*.

Page 192

Consider the misbegotten sentence "It may be raining, but it isn't".

Page 192

And here one should be on one's guard against saying that "It may be raining" really means "I think it'll be raining." For why not the other way round, why should not the latter mean the former?

Page 192

Don't regard a hesitant assertion as an assertion of hesitancy.

Page Break 193

xi

Page 193

Two uses of the word "see".

Page 193

The one: "What do you see there?"--"I see *this*" (and then a description, a drawing, a copy). The other: "I see a likeness between these two faces"--let the man I tell this to be seeing the faces as clearly as I do myself.

Page 193

The importance of this is the difference of category between the two 'objects' of sight.

Page 193

The one man might make an accurate drawing of the two faces, and the other notice in the drawing the likeness which the former did not see.

Page 193

I contemplate a face, and then suddenly notice its likeness to another. I *see* that it has not changed; and yet I see it differently. I call this experience "noticing an aspect".

Page 193

Its *causes* are of interest to psychologists.

Page 193

We are interested in the concept and its place among the concepts of experience.

Page 193

You could imagine the illustration

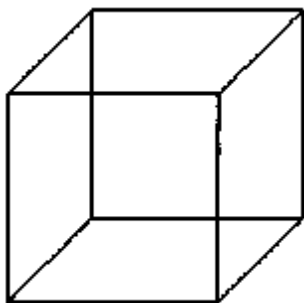

appearing in several places in a book, a text-book for instance. In the relevant text something different is in question every time: here a glass cube, there an inverted open box, there a wire frame of that shape, there three boards forming a solid angle. Each time the text supplies the interpretation of the illustration.

Page 193

But we can also *see* the illustration now as one thing now as another.--So we interpret it, and *see* it as we *interpret* it.

Page 193

Here perhaps we should like to reply: The description of what is got immediately, i.e. of the visual experience, by means of an interpretation--is an indirect description. "I see the figure as a box" means: I have a particular visual experience which I have found that I always have when I interpret the figure as a box or when I look at

Page Break 194

a box. But if it meant this I ought to know it. I ought to be able to refer to the experience directly, and not only indirectly. (As I can speak of red without calling it the colour of blood.)

Page 194

I shall call the following figure, derived from Jastrow†1, the duck-rabbit. It can be seen as a rabbit's head or as a duck's.



And I must distinguish between the 'continuous seeing' of an aspect and the 'dawning' of an aspect.

Page 194

The picture might have been shewn me, and I never have seen anything but a rabbit in it.

Page 194

Here it is useful to introduce the idea of a picture-object. For instance



would be a 'picture-face'.

Page 194

In some respects I stand towards it as I do towards a human face. I can study its expression, can react to it as to the expression of the human face. A child can talk to picture-men or picture-animals, can treat them as it treats dolls.

Page 194

I may, then, have seen the duck-rabbit simply as a picture-rabbit from the first. That is to say, if asked "What's that?" or "What do you see here?" I should have replied: "A picture-rabbit". If I had further been asked what that was, I should have explained by pointing to all sorts of pictures of rabbits, should perhaps have pointed to real rabbits, talked about their habits, or given an imitation of them.

I should not have answered the question "What do you see here?" by saying: "Now I am seeing it as a picture-rabbit". I should simply

have described my perception: just as if I had said "I see a red circle over there."--

Nevertheless someone else could have said of me: "He is seeing the figure as a picture-rabbit."

It would have made as little sense for me to say "Now I am seeing it as..." as to say at the sight of a knife and fork "Now I am seeing this as a knife and fork". This expression would not be understood.--Any more than: "Now it's a fork" or "It can be a fork too".

One doesn't *'take'* what one knows as the cutlery at a meal *for* cutlery; any more than one ordinarily tries to move one's mouth as one eats, or aims at moving it.

If you say "Now it's a face for me", we can ask: "What change are you alluding to?"

I see two pictures, with the duck-rabbit surrounded by rabbits in one, by ducks in the other. I do not notice that they are the same. Does it *follow* from this that I *see* something different in the two cases?--It gives us a reason for using this expression here.

"I saw it quite differently, I should never have recognized it!" Now, that is an exclamation. And there is also a justification for it.

I should never have thought of superimposing the heads like that, of making *this* comparison between them. For they suggest a different mode of comparison.

Nor has the head seen like *this* the slightest similarity to the head seen like *this*--although they are congruent.

I am shewn a picture-rabbit and asked what it is; I say "It's a rabbit". Not "Now it's a rabbit". I am reporting my perception.--I am shewn the duck-rabbit and asked what it is; I *may* say "It's a duck-rabbit". But I may also react to the question quite differently.--The answer that it is a duck-rabbit is again the report of a perception; the answer "Now it's a rabbit" is not. Had I replied "It's a rabbit", the ambiguity would have escaped me, and I should have been reporting my perception.

The change of aspect. "But surely you would say that the picture is altogether different now!"

But what is different: my impression? my point of view?--Can I say? I *describe* the alteration like a perception; quite as if the object had altered before my eyes.

"Now I am seeing *this*", I might say (pointing to another picture, for example). This has the form of a report of a new perception.

The expression of a change of aspect is the expression of a *new* perception and at the same time of the perception's being unchanged.

I suddenly see the solution of a puzzle-picture. Before, there were branches there; now there is a human shape. My visual impression has changed and now I recognize that it has not only shape and colour but also a quite particular 'organization'.--My visual impression has changed;--what was it like before and what is it like now?--If I represent it by means of an exact copy--and isn't that a good representation of it?--no change is shewn.

And above all do *not* say "After all my visual impression isn't the *drawing*; it is *this*--which I can't shew to anyone."--Of course it is not the drawing, but neither is it anything of the same category, which I carry within

myself.

Page 196

The concept of the 'inner picture' is misleading, for this concept uses the '*outer* picture' as a model; and yet the uses of the words for these concepts are no more like one another than the uses of 'numeral' and 'number'. (And if one chose to call numbers 'ideal numerals', one might produce a similar confusion.)

Page 196

If you put the 'organization' of a visual impression on a level with colours and shapes, you are proceeding from the idea of the visual impression as an inner object. Of course this makes this object into a chimera; a queerly shifting construction. For the similarity to a picture is now impaired.

Page 196

If I know that the schematic cube has various aspects and I want to find out what someone else sees, I can get him to make a model of what he sees, in addition to a copy, or to point to such a model; even though *he* has no idea of my purpose in demanding two accounts.

Page 196

But when we have a changing aspect the case is altered. Now the only possible expression of our experience is what before perhaps seemed, or even was, a useless specification when once we had the copy.

Page 196

And this by itself wrecks the comparison of 'organization' with colour and shape in visual impressions.

Page 196

If I saw the duck-rabbit as a rabbit, then I saw: these shapes and colours (I give them in detail)--and I saw besides something like this:

Page Break 197

and here I point to a number of different pictures of rabbits.--This shews the difference between the concepts.

Page 197

'Seeing as....' is not part of perception. And for that reason it is like seeing and again not like.

Page 197

I look at an animal and am asked: "What do you see?" I answer: "A rabbit".--I see a landscape; suddenly a rabbit runs past. I exclaim "A rabbit!"

Page 197

Both things, both the report and the exclamation, are expressions of perception and of visual experience. But the exclamation is so in a different sense from the report: it is forced from us.--It is related to the experience as a cry is to pain.

Page 197

But since it is the description of a perception, it can also be called the expression of thought.--If you are looking at the object, you need not think of it; but if you are having the visual experience expressed by the exclamation, you are also *thinking* of what you see.

Page 197

Hence the flashing of an aspect on us seems half visual experience, half thought.

Page 197

Someone suddenly sees an appearance which he does not recognize (it may be a familiar object, but in an unusual position or lighting); the lack of recognition perhaps lasts only a few seconds. Is it correct to say he has a different visual experience from someone who knew the object at once?

Page 197

For might not someone be able to describe an unfamiliar shape that appeared before him just as *accurately* as I, to whom it is familiar? And isn't that the answer?--Of course it will not generally be so. And his description will run quite differently. (I say, for example, "The animal had long ears"--he: "There were two long appendages", and then he draws them.)

Page 197

I meet someone whom I have not seen for years; I see him clearly, but fail to know him. Suddenly I know him, I see the old face in the altered one. I believe that I should do a different portrait of him now if I could paint.

Page 197

Now, when I know my acquaintance in a crowd, perhaps after looking in his direction for quite a while,--is this a special sort of seeing? Is it a case of both seeing and thinking? or an amalgam of the two, as I should almost like to say?

Page 197

The question is: *why* does one want to say this?

The very expression which is also a report of what is seen, is here a cry of recognition.

What is the criterion of the visual experience?--The criterion? What do you suppose?

The representation of 'what is seen'.

The concept of a representation of what is seen, like that of a copy, is very elastic, and so *together with it* is the concept of what is seen. The two are intimately connected. (Which is *not* to say that they are alike.)

How does one tell that human beings *see* three-dimensionally?--I ask someone about the lie of the land (over there) of which he has a view. "Is it like *this*?" (I shew him with my hand)--"Yes."--"How do you know?"--"It's not misty, I see it quite clear."--He does not give reasons for the surmise. The only thing that is natural to us is to represent what we see three-dimensionally; special practice and training are needed for two-dimensional representation whether in drawing or in words. (The queerness of children's drawings.)



If someone sees a smile and does not know it for a smile, does not understand it as such, does he see it differently from someone who understands it?--He mimics it differently, for instance.

Hold the drawing of a face upside down and you can't recognize the expression of the face. Perhaps you can see that it is smiling, but not exactly what *kind* of smile it is. You cannot imitate the smile or describe it more exactly.

And yet the picture which you have turned round may be a most exact representation of a person's face.



The figure (a) is the reverse of the figure (b)

As (c)  is the reverse of (d)  But--I should like to say--there is a different difference between my impressions of (c) and (d) and between those of (a) and (b). (d), for example, looks neater than (c). (Compare a remark of Lewis Carroll's.) (d) is easy, (c) hard to copy.

Imagine the duck-rabbit hidden in a tangle of lines. Now I suddenly notice it in the picture, and notice it simply as the head of a rabbit. At some later time I look at the same picture and notice the same figure, but see it as the duck, without necessarily realizing that it was the same figure both times.--If I later see the aspect change--can I say that the duck and rabbit aspects are now seen quite differently from when I recognized them separately in the tangle of lines? No.

But the change produces a surprise not produced by the recognition.

If you search in a figure (1) for another figure (2), and then find it, you see (1) in a new way. Not only can you give a new kind of description of it, but noticing the second figure was a new visual experience.

But you would not necessarily want to say "Figure (1) looks quite different now; it isn't even in the least like the figure I saw before, though they are congruent!"

There are here hugely many interrelated phenomena and possible concepts.

Then is the copy of the figure an *incomplete* description of my visual experience? No.--But the

circumstances decide whether, and what, more detailed specifications are necessary.--It *may* be an incomplete description; if there is still something to ask.

Page 199

Of course we can say: There are certain things which fall equally under the concept 'picture-rabbit' and under the concept 'picture-duck'. And a picture, a drawing, is such a thing.--But the *impression* is not simultaneously of a picture-duck and a picture-rabbit.

Page 199

"What I really *see* must surely be what is produced in me by the influence of the object"--Then what is produced in me is a sort of copy, something that in its turn can be looked at, can be before one; almost something like a *materialization*.

Page 199

And this materialization is something spatial and it must be possible to describe it in purely spatial terms. For instance (if it is a face) it can smile; the concept of friendliness, however, has no place in an account of it, but is *foreign* to such an account (even though it may subserve it).

Page 199

If you ask me what I saw, perhaps I shall be able to make a sketch which shews you; but I shall mostly have no recollection of the way my glance shifted in looking at it.

Page Break 200

Page 200

The concept of 'seeing' makes a tangled impression. Well, it is tangled.--I look at the landscape, my gaze ranges over it, I see all sorts of distinct and indistinct movement; *this* impresses itself sharply on me, *that* is quite hazy. After all, how completely ragged what we see can appear! And now look at all that can be meant by "description of what is seen".--But this just is what is called description of what is seen. There is not *one genuine* proper case of such description--the rest being just vague, something which awaits clarification, or which must just be swept aside as rubbish.

Page 200

Here we are in enormous danger of wanting to make fine distinctions.--It is the same when one tries to define the concept of a material object in terms of 'what is really seen'.--What we have rather to do is to *accept* the everyday language-game, and to note *false* accounts of the matter *as* false. The primitive language-game which children are taught needs no justification; attempts at justification need to be rejected.

Page 200

Take as an example the aspects of a triangle. This triangle

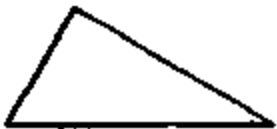

can be seen as a triangular hole, as a solid, as a geometrical drawing; as standing on its base, as hanging from its apex; as a mountain, as a wedge, as an arrow or pointer, as an overturned object which is meant to stand on the shorter side of the right angle, as a half parallelogram, and as various other things.

Page 200

"You can think now of *this* now of *this* as you look at it, can regard it now as *this* now as *this*, and then you will see it now *this* way, now *this*."--*What* way? There *is* no further qualification.

Page 200

But how is it possible to *see* an object according to an *interpretation*?--The question represents it as a queer fact; as if something were being forced into a form it did not really fit. But no squeezing, no forcing took place here.

Page 200

When it looks as if there were no room for such a form between other ones you have to look for it in another dimension. If there is no room here, there *is* room in another dimension.

Page Break 201

Page 201

(It is in this sense too that there is no room for imaginary numbers in the continuum of real numbers. But what this means is: the application of the concept of imaginary numbers is less like that of real numbers than appears from the look of the *calculations*. It is necessary to get down to the application, and then the concept finds a different place, one which, so to speak, one never dreamed of.)

Page 201

How would the following account do: "What I can see something as, is what it can be a picture of"?

Page 201

What this means is: the aspects in a change of aspects are those ones which the figure might sometimes have *permanently* in a picture.

Page 201

A triangle can really be *standing up* in one picture, be hanging in another, and can in a third be something that has fallen over.--That is, I who am looking at it say, not "It may also be something that has fallen over", but "That glass has fallen over and is lying there in fragments". This is how we react to the picture.

Page 201

Could I say what a picture must be like to produce this effect? No. There are, for example, styles of painting which do not convey anything to me in this immediate way, but do to other people. I think custom and upbringing have a hand in this.

Page 201

What does it mean to say that I '*see the sphere floating in the air*' in a picture?

Page 201

Is it enough that this description is the first to hand, is the matter-of-course one? No, for it might be so for various reasons. This might, for instance, simply be the conventional description.

Page 201

What is the expression of my not merely understanding the picture in this way, for instance, (knowing what it is *supposed* to be), but *seeing* it in this way?--It is expressed by: "The sphere seems to float", "You see it floating", or again, in a special tone of voice, "It floats!"

Page 201

This, then, is the expression of taking something for something. But not being used as such.

Page 201

Here we are not asking ourselves what are the causes and what produces this impression in a particular case.

Page 201

And *is* it a special impression?--"Surely I see something *different* when I see the sphere floating from when I merely see it lying there."--This really means: This expression is justified!--(For taken literally it is no more than a repetition.)

Page Break 202

Page 202

(And yet my impression is not that of a real floating sphere either. There are various forms of 'three-dimensional seeing'. The three-dimensional character of a photograph and the three-dimensional character of what we see through a stereoscope.)

Page 202

"And is it really a different impression?"--In order to answer this I should like to ask myself whether there is really something different there in me. But how can I find out?--I *describe* what I am seeing differently.

Page 202

Certain drawings are always seen as flat figures, and others sometimes, or always, three-dimensionally.

Page 202

Here one would now like to say: the visual impression of what is seen three-dimensionally is three-dimensional; with the schematic cube, for instance, it is a cube. (For the description of the impression is the description of a cube.)

Page 202

And then it seems queer that with some drawings our impression should be a flat thing, and with some a three-dimensional thing. One asks oneself "Where is this going to end?"

Page 202

When I see the picture of a galloping horse--do I merely *know* that this is the kind of movement meant? Is it superstition to think I *see* the horse galloping in the picture?--And does my visual impression gallop too?

Page 202

What does anyone tell me by saying "Now I see it as....."? What consequences has this information? What can I do with it?

Page 202

People often associate colours with vowels. Someone might find that a vowel changed its colour when it was repeated over and over again. He finds *a* 'now blue--now red', for instance.

Page 202

The expression "Now I am seeing it as..." might have no more significance for us than: "Now I find *a* red".

(Linked with physiological observations, even this change might acquire importance for us.)

Here it occurs to me that in conversation on aesthetic matters we use the words: "You have to see it like *this*, this is how it is meant"; "When you see it like *this*, you see where it goes wrong"; "You have to hear this bar as an introduction"; "You must hear it in this key"; "You must phrase it like *this*" (which can refer to hearing as well as to playing).

This figure

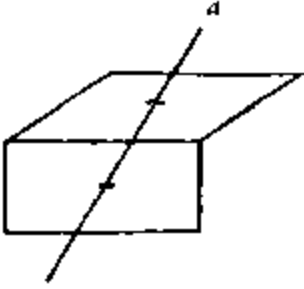

is supposed to represent a convex step and to be used in some kind of topological demonstration. For this purpose we draw the straight line *a* through the geometric centres of the two surfaces.--Now if anyone's three-dimensional impression of the figure were never more than momentary, and even so were now concave, now convex, that might make it difficult for him to follow our demonstration. And if he finds that the flat aspect alternates with a three-dimensional one, that is just as if I were to shew him completely different objects in the course of the demonstration.

What does it mean for me to look at a drawing in descriptive geometry and say: "I know that this line appears again here, but I can't *see* it like that"? Does it simply mean a lack of familiarity in operating with the drawing; that I don't 'know my way about' too well?--This familiarity is certainly one of our criteria. What tells us that someone is seeing the drawing three-dimensionally is a certain kind of 'knowing one's way about'. Certain gestures, for instance, which indicate the three-dimensional relations: fine shades of behaviour.

I see that an animal in a picture is transfixed by an arrow. It has struck it in the throat and sticks out at the back of the neck. Let the picture be a silhouette.--Do you *see* the arrow--or do you merely *know* that these two bits are supposed to represent part of an arrow?

(Compare Köhler's figure of the interpenetrating hexagons.)

"But this isn't *seeing!*"--"But this is seeing!"--It must be possible to give both remarks a conceptual justification.

But this is seeing! *In what sense* is it seeing?

"The phenomenon is at first surprising, but a physiological explanation of it will certainly be found."--

Our problem is not a causal but a conceptual one.

If the picture of the transfixed beast or of the interpenetrating hexagons were shewn to me just for a moment and then I had to describe it, *that* would be my description; if I had to draw it I should

certainly produce a very faulty copy, but it would shew some sort of animal transfixed by an arrow, or two hexagons interpenetrating. That is to say: there are certain mistakes that I should *not* make.

The first thing to jump to my eye in this picture is: there are two hexagons.

Now I look at them and ask myself: "Do I really see them *as* hexagons?"--and for the whole time they are before my eyes? (Assuming that they have not changed their aspect in that time.)--And I should like to reply: "I am not thinking of them as hexagons the whole time."

Page 204

Someone tells me: "I saw it at once as two hexagons. And that's the *whole* of *what* I saw." But how do I understand this? I think he would have given this description at once in answer to the question "What are you seeing?", nor would he have treated it as one among several possibilities. In this his description is like the answer "A face" on being shewn the figure



Page 204

The best description I can give of what was shewn me for a moment is *this*:.....

Page 204

"The impression was that of a rearing animal." So a perfectly definite description came out.--Was it *seeing*, or was it a thought?

Page 204

Do not try to analyse your own inner experience.

Page 204

Of course I might also have seen the picture first as something different, and then have said to myself "Oh, it's two hexagons!" So the aspect would have altered. And does this prove that I in fact saw it as something definite?

Page 204

"Is it a *genuine* visual experience?" The question is: in what sense is it one?

Page 204

Here it is *difficult* to see that what is at issue is the fixing of concepts.

Page 204

A *concept* forces itself on one. (This is what you must not forget.)

Page 204

For when should I call it a mere case of knowing, not seeing?--Perhaps when someone treats the picture as a working drawing, *reads* it like a blueprint. (Fine shades of behaviour.--Why are they *important*? They have important consequences.)

Page Break 205

Page 205

"To me it is an animal pierced by an arrow." That is what I treat it as; this is my *attitude* to the figure. This is one meaning in calling it a case of 'seeing'.

Page 205

But can I say in the same sense: "To me these are two hexagons"? Not in the same sense, but in a similar one.

Page 205

You need to think of the role which pictures such as paintings (as opposed to working drawings) have in our lives. This role is by no means a uniform one.

Page 205

A comparison: texts are sometimes hung on the wall. But not theorems of mechanics. (Our relation to these two things.)

Page 205

If you see the drawing as such-and-such an animal, what I expect from you will be pretty different from what I expect when you merely know what it is meant to be.

Page 205

Perhaps the following expression would have been better: we *regard* the photograph, the picture on our wall, as the object itself (the man, landscape, and so on) depicted there.

Page 205

This need not have been so. We could easily imagine people who did not have this relation to such pictures. Who, for example, would be repelled by photographs, because a face without colour and even perhaps a face

reduced in scale struck them as inhuman.

Page 205

I say: "We regard a portrait as a human being,"--but when do we do so, and for how long? *Always*, if we see it at all (and do not, say, see it as something else)?

Page 205

I might say yes to this, and that would determine the concept of regarding-as.--The question is whether yet another concept, related to this one, is also of importance to us: that, namely, of a seeing--as which only takes place while I am actually concerning myself with the picture as the object depicted.

Page 205

I might say: a picture does not always *live* for me while I am seeing it.

Page 205

"Her picture smiles down on me from the wall." It need not always do so, whenever my glance lights on it.

Page 205

The duck-rabbit. One asks oneself: how can the eye--this *dot*--be looking in a direction?--"*See, it is looking!*" (And one 'looks' oneself as one says this.) But one does not say and do this the whole time one is looking at the picture. And now, what is this "See, it's looking!"--does it express a sensation?

Page Break 206

Page 206

(In giving all these examples I am not aiming at some kind of completeness, some classification of psychological concepts. They are only meant to enable the reader to shift for himself when he encounters conceptual difficulties.)

Page 206

"Now I see it as a...." goes with "I am trying to see it as a...." or "I can't see it as a.... yet". But I cannot try to see a conventional picture of a lion *as* a lion, any more than an F as that letter. (Though I may well try to see it as a gallows, for example.)

Page 206

Do not ask yourself "How does it work with *me*?"--Ask "What do I know about someone else?"

Page 206

How does one play the game: "It could be *this* too"? (What a figure could also be--which is what it can be

seen as--is not simply another figure. If someone said "I see

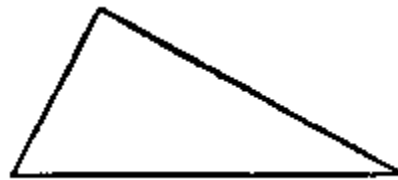

as

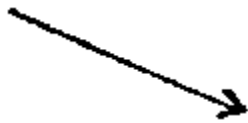

", he might still be meaning very different things.)

Page 206

Here is a game played by children: they say that a chest, for example, is a house; and thereupon it is interpreted as a house in every detail. A piece of fancy is worked into it.

Page 206

And does the child now *see* the chest as a house?

Page 206

"He quite forgets that it is a chest; for him it actually is a house." (There are definite tokens of this.) Then would it not also be correct to say he *sees* it as a house?

Page 206

And if you knew how to play this game, and, given a particular situation, you exclaimed with special expression "Now it's a house!"--you would be giving expression to the dawning of an aspect.

Page 206

If I heard someone talking about the duck-rabbit, and *now* he spoke in a certain way about the special expression of the rabbit's face I should say, now he's seeing the picture as a rabbit.

Page 206

But the expression in one's voice and gestures is the same as if the object had altered and had ended by *becoming* this or that.

Page 206

I have a theme played to me several times and each time in a slower tempo. In the end I say "Now it's right", or "Now at last it's a march", "Now at last it's a dance".--The same tone of voice expresses the dawning of an aspect.

Page Break 207

Page 207

'Fine shades of behaviour.'--When my understanding of a theme is expressed by my whistling it with the correct expression, this is an example of such fine shades.

Page 207

The aspects of the triangle: it is as if an *image* came into contact, and for a time remained in contact, with the visual impression.

Page 207

In this, however, these aspects differ from the concave and convex aspects of the step (for example). And also from the aspects of the figure



(which I shall call a "double cross") as a white cross on a black ground and as a black cross on a white ground.

Page 207

You must remember that the descriptions of the alternating aspects are of a different kind in each case.

Page 207

(The temptation to say "I see it like *this*", pointing to the same thing for "it" and "this".) Always get rid of the idea of the private object in this way: assume that it constantly changes, but that you do not notice the change because your memory constantly deceives you.

Page 207

Those two aspects of the double cross (I shall call them the aspects A) might be reported simply by pointing alternately to an isolated white and an isolated black cross.

Page 207

One could quite well imagine this as a primitive reaction in a child even before it could talk.

Page 207

(Thus in reporting the aspects A we point to a part of the double cross.--The duck and rabbit aspects could not be described in an analogous way.)

Page 207

You only 'see the duck and rabbit aspects' if you are already conversant with the shapes of those two animals. There is no analogous condition for seeing the aspects A.

Page 207

It is possible to take the duck-rabbit simply for the picture of a rabbit, the double cross simply for the picture of a black cross, but not to take the bare triangular figure for the picture of an object that has fallen over. To see this aspect of the triangle demands *imagination*.

Page Break 208

Page 208

The aspects A are not essentially three-dimensional; a black cross on a white ground is not essentially a cross with a white surface in the background. You could teach someone the idea of the black cross on a ground of different colour without shewing him anything but crosses painted on sheets of paper. Here the 'background' is simply the surrounding of the cross.

Page 208

The aspects A are not connected with the possibility of illusion in the same way as are the three-dimensional aspects of the drawing of a cube or step.

Page 208

I can see the schematic cube as a box;--but can I also see it now as a paper, now as a tin, box?--What ought I to say, if someone assured me *he* could?--I can set a limit to the concept here.

Page 208

Yet think of the expression "*felt*" in connexion with looking at a picture. ("One feels the softness of that material.") (*Knowing* in dreams. "And I *knew* that... was in the room.")

Page 208

How does one teach a child (say in arithmetic) "Now take *these* things together!" or "Now *these* go together"? Clearly "taking together" and "going together" must originally have had another meaning for him than that of *seeing* in this way or that.--And this is a remark about concepts, not about teaching methods.

Page 208

One *kind* of aspect might be called 'aspects of organization'. When the aspect changes parts of the picture go together which before did not.

Page 208

In the triangle I can see now *this* as apex, *that* as base--now *this* as apex, *that* as base.--Clearly the words "Now I am seeing *this* as the apex" cannot so far mean anything to a learner who has only just met the concepts of apex, base, and so on.--But I do not mean this as an empirical proposition.

Page 208

"Now he's seeing it like *this*", "now like *that*" would only be said of someone *capable* of making certain applications of the figure quite freely.

Page 208

The substratum of this experience is the mastery of a technique.

Page 208

But how queer for this to be the logical condition of someone's having such-and-such an *experience*! After all, you don't say that one only 'has toothache' if one is capable of doing such-and-such.--From this it follows that we cannot be dealing with the same concept of experience here. It is a different though related concept.

Page Break 209

Page 209

It is only if someone *can do*, has learnt, is master of, such-and-such, that it makes sense to say he has had *this* experience.

Page 209

And if this sounds crazy, you need to reflect that the *concept* of seeing is modified here. (A similar consideration is often necessary to get rid of a feeling of dizziness in mathematics.)

Page 209

We talk, we utter words, and only *later* get a picture of their life.

Page 209

For how could I see that this posture was hesitant before I knew that it was a posture and not the anatomy of the animal?

Page 209

But surely that only means that I cannot use *this* concept to describe the object of sight, just because it has *more* than purely visual reference?--Might I not for all that have a purely visual concept of a hesitant posture, or of a timid face?

Page 209

Such a concept would be comparable with 'major' and 'minor' which certainly have emotional value, but can also be used purely to describe a perceived structure.

Page 209

The epithet "sad", as applied for example to the outline face, characterizes the grouping of lines in a circle. Applied to a human being it has a different (though related) meaning. (But this does *not* mean that a sad expression is *like* the feeling of sadness!)

Page 209

Think of this too: I can only see, not hear, red and green,--but sadness I can hear as much as I can see it.

Page 209

Think of the expression "I heard a plaintive melody". And now the question is: "Does he *hear* the plaint?"

Page 209

And if I reply: "No, he doesn't hear it, he merely has a sense of it"--where does that get us? One cannot mention a sense-organ for this 'sense'.

Page 209

Some would like to reply here: "Of course I hear it!"--Others: "I don't really *hear* it."

Page 209

We can, however, establish differences of concept here.

We react to the visual impression differently from someone who does not recognize it as timid (in the *full* sense of the word).--But I do *not* want to say here that we feel this reaction in our muscles and joints and that this is the 'sensing'.--No, what we have here is a modified concept of *sensation*.

One might say of someone that he was blind to the *expression* of a face. Would his eyesight on that account be defective?

This is, of course, not simply a question for physiology. Here the physiological is a symbol of the logical.

If you feel the seriousness of a tune, what are you perceiving?--Nothing that could be conveyed by reproducing what you heard.

I can imagine some arbitrary cipher--this, for instance:  --to be a strictly correct letter of some foreign alphabet. Or again, to be a faultily written one, and faulty in this way or that: for example, it might be slap-dash, or typical childish awkwardness, or like the flourishes in a legal document. It could deviate from the correctly written letter in a variety of ways.--And I can see it in various aspects according to the fiction I surround it with. And here there is a close kinship with 'experiencing the meaning of a word'.

I should like to say that what dawns here lasts only as long as I am occupied with the object in a particular way. ("See, it's looking!")--I should like to say--and *is* it so?--Ask yourself "For how long am I struck by a thing?"--For how long do I find it *new*?

The aspect presents a physiognomy which then passes away. It is almost as if there were a face there which at first I *imitate*, and then accept without imitating it.--And isn't this really explanation enough?--But isn't it too much?

"I observed the likeness between him and his father for a few minutes, and then no longer."--One might say this if his face were changing and only looked like his father's for a short time. But it can also mean that after a few minutes I stopped being struck by the likeness.

"After the likeness had struck you, how long were you aware of it?" What kind of answer might one give to this question?--"I soon stopped thinking about it", or "It struck me again from time to time", or "I several times had the thought, how like they are!", or "I marvelled at the likeness for at least a minute"--That is the sort of answer you would get.

I should like to put the question "Am I *aware* of the spatial character, the depth of an object (of this cupboard for instance), the *whole* time

I am seeing it?" Do I, so to speak, *feel* it the whole time?--But put the question in the third person.--When would you say of someone that he was aware of it the whole time, and when the opposite?--Of course, one could ask him,--but how did he learn how to answer such a question?--He knows what it means "to feel pain continuously". But that will only confuse him here (as it confuses me).

If he now says he is continuously aware of the depth--do I believe him? And if he says he is aware of it only occasionally (when talking about it, perhaps)--do I believe *that*? These answers will strike me as resting on a false foundation.--It will be different if he says that the object sometimes strikes him as flat, sometimes as three-dimensional.

Someone tells me: "I looked at the flower, but was thinking of something else and was not conscious of its colour." Do I understand this?--I can imagine a significant context, say his going on: "Then I suddenly saw it, and realized it was the one which.....".

Or again: "If I had turned away then, I could not have said what colour it was."

Page 211

"He looked at it without seeing it."--There is such a thing. But what is the criterion for it?--Well, there is a variety of cases here.

Page 211

"Just now I looked at the shape rather than at the colour." Do not let such phrases confuse you. Above all, don't wonder "What can be going on in the eyes or brain?"

Page 211

The likeness makes a striking impression on me; then the impression fades.

Page 211

It only struck me for a few minutes, and then no longer did.

Page 211

What happened here?--What can I recall? My own facial expression comes to mind; I could reproduce it. If someone who knew me had seen my face he would have said "Something about his face struck you just now".--There further occurs to me what I say on such an occasion, out loud or to myself. And that is all.--And is this what being struck is? No. These are the phenomena of being struck; but they *are* 'what happens'.

Page 211

Is being struck looking plus thinking? No. Many of our concepts *cross* here.

Page 211

('Thinking' and 'inward speech'--I do not say 'to oneself'--are different concepts.)

Page Break 212

Page 212

The colour of the visual impression corresponds to the colour of the object (this blotting paper looks pink to me, and is pink)--the shape of the visual impression to the shape of the object (it looks rectangular to me, and is rectangular)--but what I perceive in the dawning of an aspect is not a property of the object, but an internal relation between it and other objects.

Page 212

It is almost as if 'seeing the sign in this context' were an echo of a thought.

Page 212

"The echo of a thought in sight"--one would like to say.

Page 212

Imagine a physiological explanation of the experience. Let it be this: When we look at the figure, our eyes scan it repeatedly, always following a particular path. The path corresponds to a particular pattern of oscillation of the eyeballs in the act of looking. It is possible to jump from one such pattern to another and for the two to alternate. (Aspects A.) Certain patterns of movement are physiologically impossible; hence, for example, I cannot see the schematic cube as two interpenetrating prisms. And so on. Let this be the explanation.--"Yes, that shews it is a kind of *seeing*."--You have now introduced a new, a physiological, criterion for seeing. And this can screen the old problem from view, but not solve it.--The purpose of this paragraph however, was to bring before our view what happens when a physiological explanation is offered. The psychological concept hangs out of reach of this explanation. And this makes the nature of the problem clearer.

Page 212

Do I really see something different each time, or do I only interpret what I see in a different way? I am inclined to say the former. But why?--To interpret is to think, to do something; seeing is a state.

Page 212

Now it is easy to recognize cases in which we are *interpreting*. When we interpret we form hypotheses, which may prove false.--"I am seeing this figure as a...." can be verified as little as (or in the same sense as) "I am seeing bright red". So there is a similarity in the use of "seeing" in the two contexts. Only do not think you knew in advance what the "*state of seeing*" means here! Let the use *teach* you the meaning.

Page 212

We find certain things about seeing puzzling, because we do not find the whole business of seeing puzzling enough.

Page Break 213

Page 213

If you look at a photograph of people, houses and trees, you do not feel the lack of the third dimension in it. We should not find it easy to describe a photograph as a collection of colour-patches on a flat surface; but what we

see in a stereoscope looks three-dimensional in a different way again.

Page 213

(It is anything but a matter of course that we see 'three-dimensionally' with two eyes. If the two visual images are amalgamated, we might expect a blurred one as a result.)

Page 213

The concept of an aspect is akin to the concept of an image. In other words: the concept 'I am now seeing it as...' is akin to 'I am now having *this* image'.

Page 213

Doesn't it take imagination to hear something as a variation on a particular theme? And yet one is perceiving something in so hearing it.

Page 213

"Imagine this changed like this, and you have this other thing." One can use imagining in the course of proving something.

Page 213

Seeing an aspect and imagining are subject to the will. There is such an order as "Imagine *this*", and also: "Now see the figure like *this*"; but not: "Now see this leaf green".

Page 213

The question now arises: Could there be human beings lacking in the capacity to see something *as something*--and what would that be like? What sort of consequences would it have?--Would this defect be comparable to colour-blindness or to not having absolute pitch?--We will call it "aspect-blindness"--and will next consider what might be meant by this. (A conceptual investigation.) The aspect-blind man is supposed not to see the aspects A change. But is he also supposed not to recognize that the double cross contains both a black and a white cross? So if told "Shew me figures containing a black cross among these examples" will he be unable to manage it? No, he should be able to do that; but he will not be supposed to say: "Now it's a black cross on a white ground!"

Page 213

Is he supposed to be blind to the similarity between two faces?--And so also to their identity or approximate identity? I do not want to settle this. (He ought to be able to execute such orders as "Bring me something that looks like *this*.")

Page 213

Ought he to be unable to see the schematic cube as a cube?--It would not follow from that that he could not recognize it as a representation (a working drawing for instance) of a cube. But for him it

Page Break 214

would not jump from one aspect to the other.--Question: Ought he to be able to *take* it as a cube in certain circumstances, as we do?--If not, this could not very well be called a sort of blindness.

Page 214

The 'aspect-blind' will have an altogether different relationship to pictures from ours.

Page 214

(Anomalies of *this* kind are easy for us to imagine.)

Page 214

Aspect-blindness will be *akin* to the lack of a 'musical ear'.

Page 214

The importance of this concept lies in the connexion between the concepts of 'seeing an aspect' and 'experiencing the meaning of a word'. For we want to ask "What would you be missing if you did not *experience* the meaning of a word?"

Page 214

What would you be missing, for instance, if you did not understand the request to pronounce the word "till" and to mean it as a verb,--or if you did not feel that a word lost its meaning and became a mere sound if it was repeated ten times over?

Page 214

In a law-court, for instance, the question might be raised how someone meant a word. And this can be inferred from certain facts.--It is a question of *intention*. But could how he experienced a word--the word "bank" for instance--have been significant in the same way?

Page 214

Suppose I had agreed on a code with someone; "tower" means bank. I tell him "Now go to the tower"--he understands me and acts accordingly, but he feels the word "tower" to be strange in this use, it has not yet 'taken on' the meaning.

"When I read a poem or narrative with feeling, surely something goes on in me which does not go on when I merely skim the lines for information."--What processes am I alluding to?--The sentences have a different *ring*. I pay careful attention to my intonation. Sometimes a word has the wrong intonation, I emphasize it too much or too little. I notice this and shew it in my face. I might later talk about my reading in detail, for example about the mistakes in my tone of voice. Sometimes a picture, as it were an illustration, comes to me. And this seems to help me to read with the correct expression. And I could mention a good deal more of the same kind.--I can also give a word a tone of voice which brings out the meaning of the rest, almost as if this word were a picture of the whole thing. (And this may, of course, depend on sentence-formation.)

When I pronounce this word while reading with expression it is completely filled with its meaning.--"How can this be, if meaning is the use of the word?" Well, what I said was intended figuratively. Not that I chose the figure: it forced itself on me.--But the figurative employment of the word can't get into conflict with the original one.

Perhaps it could be explained why precisely *this* picture suggests itself to me. (Just think of the expression, and the meaning of the expression: "the word that hits it off".)

But if a sentence can strike me as like a painting in words, and the very individual word in the sentence as like a picture, then it is no such marvel that a word uttered in isolation and without purpose can seem to carry a particular meaning in itself.

Think here of a special kind of illusion which throws light on these matters.--I go for a walk in the environs of a city with a friend. As we talk it comes out that I am imagining the city to lie on our right. Not only have I *no* conscious reason for this assumption, but some quite simple consideration was enough to make me realize that the city lay rather to the left ahead of us. I can at first give no answer to the question *why* I imagine the city in *this* direction. I had *no reason* to think it. But though I see no reason still I seem to see certain psychological causes for it. In particular, certain associations and memories. For example, we walked along a canal, and once before in similar circumstances I had followed a canal and that time the city lay on our right.--I might try as it were psychoanalytically to discover the causes of my unfounded conviction.

"But what is this queer experience?"--Of course it is not queerer than any other; it simply differs in kind from those experiences which we regard as the most fundamental ones, our sense impressions for instance.

"I feel as if I knew the city lay over there."--"I feel as if the name 'Schubert' fitted Schubert's works and Schubert's face."

You can say the word "March" to yourself and mean it at one time as an imperative at another as the name of a month. And now say "March!"--and then "March *no further!*"--Does the *same* experience accompany the word both times--are you sure?

If a sensitive ear shews me, when I am playing this game, that I have now *this* now *that* experience of the word--doesn't it also shew

me that I often do not have *any* experience of it in the course of talking?--For the fact that I then also mean it, intend it, now like *this* now like *that*, and maybe also say so later is, of course, not in question.

But the question now remains why, in connexion with this *game* of experiencing a word, we also speak of 'the meaning' and of 'meaning it'.--This is a different kind of question.--It is the phenomenon which is characteristic of this language-game that in *this* situation we use this expression: we say we pronounced the word with *this* meaning and take this expression over from that other language-game.

Call it a dream. It does not change anything.

Given the two ideas 'fat' and 'lean', would you be rather inclined to say that Wednesday was fat and Tuesday

lean, or the other way round? (I incline to choose the former.) Now have "fat" and "lean" some different meaning here from their usual one?--They have a different use.--So ought I really to have used different words? Certainly not that.--I want to use *these* words (with their familiar meanings) *here*.--Now, I say nothing about the causes of this phenomenon. They *might* be associations from my childhood. But that is a hypothesis. Whatever the explanation,--the inclination is there.

Page 216

Asked "What do you really mean here by 'fat' and 'lean'?"--I could only explain the meanings in the usual way. I could *not* point to the examples of Tuesday and Wednesday.

Page 216

Here one might speak of a 'primary' and 'secondary' sense of a word. It is only if the word has the primary sense for you that you use it in the secondary one.

Page 216

Only if you have learnt to calculate--on paper or out loud--can you be made to grasp, by means of this concept, what calculating in the head is.

Page 216

The secondary sense is not a 'metaphorical' sense. If I say "For me the vowel *e* is yellow" I do not mean: 'yellow' in a metaphorical sense,--for I could not express what I want to say in any other way than by means of the idea 'yellow'.

Page 216

Someone tells me: "Wait for me by the bank". Question: Did you, *as you were saying the word*, mean this bank?--This question is of the same kind as "Did you intend to say such-and-such to him on your way to meet him?" It refers to a definite time (the time of walking, as the former question refers to the time of speaking)--but not to an

Page Break 217

experience during that time. Meaning is as little an experience as intending.

Page 217

But what distinguishes them from experience?--They have no experience-content. For the contents (images for instance) which accompany and illustrate them are not the meaning or intending.

Page 217

The intention *with which* one acts does not 'accompany' the action any more than the thought 'accompanies' speech. Thought and intention are neither 'articulated' nor 'non-articulated'; to be compared neither with a single note which sounds during the acting or speaking, nor with a tune.

Page 217

'Talking' (whether out loud or silently) and 'thinking' are not concepts of the same kind; even though they are in closest connexion.

Page 217

The *interest* of the experiences one has while speaking and of the intention is not the same. (The experiences might perhaps inform a psychologist about the '*unconscious*' intention.)

Page 217

"At that word we both thought of him." Let us assume that each of us said the same words to himself--and how can it mean MORE than that?--But wouldn't even those words be only a *germ*? They must surely belong to a language and to a context, in order really to be the expression of the thought *of* that man.

Page 217

If God had looked into our minds he would not have been able to see there whom we were speaking of.

Page 217

"Why did you look at me at that word, were you thinking of....?"--So there is a reaction at a certain moment and it is explained by saying "I thought of...." or "I suddenly remembered...."

Page 217

In saying this you refer to that moment in the time you were speaking. It makes a difference whether you refer to this or to that moment.

Page 217

Mere explanation of a word does not refer to an occurrence at the moment of speaking.

Page 217

The language-game "I mean (or meant) *this*" (subsequent explanation of a word) is quite different from this one: "I thought of.... as I said it." The latter is akin to "It reminded me of...."

Page 217

"I have already remembered three times today that I must write to him." Of what importance is it what went on in me then?--On the

Page Break 218

other hand what is the importance, what the interest, of the statement itself?--It permits certain conclusions.

Page 218

"At these words *he* occurred to me."--What is the primitive reaction with which the language-game begins--which can then be translated into these words? How do people get to use these words?

Page 218

The primitive reaction may have been a glance or a gesture, but it may also have been a word.

Page 218

"Why did you look at me and shake your head?"--"I wanted to give you to understand that you....." This is supposed to express not a symbolic convention but the purpose of my action.

Page 218

Meaning it is not a process which accompanies a word. For no *process* could have the consequences of meaning.

Page 218

(Similarly, I think, it could be said: a calculation is not an experiment, for no experiment could have the peculiar consequences of a multiplication.)

Page 218

There are important accompanying phenomena of talking which are often missing when one talks without thinking, and this is characteristic of talking without thinking. But *they* are not the thinking.

Page 218

"Now I know!" What went on here?--So did I *not* know, when I declared that now I knew?

Page 218

You are looking at it wrong.

Page 218

(What is the signal for?)

Page 218

And could the 'knowing' be called an accompaniment of the exclamation?

Page 218

The familiar physiognomy of a word, the feeling that it has taken up its meaning into itself, that it is an actual likeness of its meaning--there could be human beings to whom all this was alien. (They would not have an attachment to their words.)--And how are these feelings manifested among us?--By the way we choose and value words.

Page 218

How do I find the 'right' word? How do I choose among words? Without doubt it is sometimes as if I were comparing them by fine differences of smell: *That* is too....., *that* is too.....,--*this* is the right one.--But I do not always have to make judgments, give explanations; often I might only say: "It simply isn't right yet". I am dissatisfied, I go on looking. At last a word comes: "*That's* it!" *Sometimes* I can say why. This is simply what searching, this is what finding, is like here.

Page Break 219

Page 219

But doesn't the word that occurs to you somehow 'come' in a special way? Just attend and you'll see!--Careful attention is no use to me. All it could discover would be what is *now* going on in *me*.

Page 219

And how can I, precisely now, listen for it at all? I ought to have to wait until a word occurs to me anew. This, however, is the queer thing: it seems as though I did not have to wait on the occasion, but could give myself an exhibition of it, even when it is not actually taking place. How?--I *act* it.--But *what* can I learn in this way? What do I reproduce?--Characteristic accompaniments. Primarily: gestures, faces, tones of voice.

Page 219

It is possible--and this is important--to say a *great deal* about a fine aesthetic difference.--The first thing you say may, of course, be just: "*This* word fits, *that* doesn't"--or something of the kind. But then you can discuss all the extensive ramifications of the tie-up effected by each of the words. That first judgment is *not* the end of the matter, for it is the field of force of a word that is decisive.

Page 219

"The word is on the tip of my tongue." What is going on in my consciousness? That is not the point at all. Whatever did go on was not what was meant by that expression. It is of more interest what went on in my behaviour.--"The word is on the tip of my tongue" tells you: the word which belongs here has escaped me, but I hope to find it soon. For the rest the verbal expression does no more than certain wordless behaviour.

Page 219

James, in writing of this subject, is really trying to say: "What a remarkable experience! The word is not there yet, and yet in a certain sense is there,--or something is there, which *cannot* grow into anything but this word."--But this is not experience at all. *Interpreted* as experience it does indeed look odd. As does intention, when it is interpreted as the accompaniment of action; or again, like minus one interpreted as a cardinal number.

Page 219

The words "It's on the tip of my tongue" are no more the expression of an experience than "Now I know how to go on!"--We use them in *certain situations*, and they are surrounded by behaviour of a special kind, and also by some characteristic experiences. In particular they are frequently followed by *finding* the word. (Ask yourself: "What would it be like if human beings *never* found the word that was on the tip of their tongue?")

Page Break 220

Page 220

Silent 'internal' speech is not a half hidden phenomenon which is as it were seen through a veil. It is not hidden *at all*, but the concept may easily confuse us, for it runs over a long stretch cheek by jowl with the concept of an 'outward' process, and yet does not coincide with it.

Page 220

(The question whether the muscles of the larynx are innervated in connexion with internal speech, and similar things, may be of great interest, but not in our investigation.)

Page 220

The close relationship between 'saying inwardly' and 'saying' is manifested in the possibility of telling out loud what one said inwardly, and of an outward action's *accompanying* inward speech. (I can sing inwardly, or read silently, or calculate in my head, and beat time with my hand as I do so.)

Page 220

"But saying things inwardly is surely a certain activity which I have to learn!" Very well; but what is 'doing' and what is 'learning' here?

Page 220

Let the use of words teach you their meaning. (Similarly one can often say in mathematics: let the *proof* teach you *what* was being proved.)

Page 220

"So I don't *really* calculate, when I calculate in my head?"--After all, you yourself distinguish between calculation in the head and perceptible calculation! But you can only learn what 'calculating in the head' is by learning what 'calculating' is; you can only learn to calculate in your head by learning to calculate.

Page 220

One can say things in one's head very 'distinctly', when one reproduces the tone of voice of one's sentences by humming (with closed lips). Movements of the larynx help too. But the remarkable thing is precisely that one then *hears* the talk in one's imagination and does not merely *feel* the skeleton of it, so to speak, in one's larynx. (For human beings could also well be imagined calculating silently with movements of the larynx, as one can calculate on one's fingers.)

Page 220

A hypothesis, such as that such-and-such went on in our bodies when we made internal calculations, is only of interest to us in that it points to a possible use of the expression "I said.... to myself"; namely that of inferring the physiological process from the expression.

Page 220

That what someone else says to himself is hidden from me is part of the *concept* 'saying inwardly'. Only "hidden" is the wrong word

Page Break 221

here; for if it is hidden from me, it ought to be apparent to him, *he* would have to *know* it. But he does not 'know' it; only, the doubt which exists for me does not exist for him.

Page 221

"What anyone says to himself within himself is hidden from me" might of course also mean that I can for the most part not *guess* it, nor can I read it off from, for example, the movements of his throat (which would be a

possibility.)

Page 221

"I know what I want, wish, believe, feel,....." (and so on through all the psychological verbs) is either philosophers' nonsense, or at any rate *not* a judgment *a priori*.

Page 221

"I know..." may mean "I do not doubt..." but does not mean that the words "I doubt..." are *senseless*, that doubt is logically excluded.

Page 221

One says "I know" where one can also say "I believe" or "I suspect"; where one can find out. (If you bring up against me the case of people's saying "But I must know if I am in pain!", "Only you can know what you feel", and similar things, you should consider the occasion and purpose of these phrases. "War is war" is not an example of the law of identity, either.)

Page 221

It is possible to imagine a case in which I *could* find out that I had two hands. Normally, however, I *cannot* do so. "But all you need is to hold them up before your eyes!"--If I am *now* in doubt whether I have two hands, I need not believe my eyes either. (I might just as well ask a friend.)

Page 221

With this is connected the fact that, for instance, the proposition "The Earth has existed for millions of years" makes clearer sense than "The Earth has existed in the last five minutes". For I should ask anyone who asserted the latter: "What observations does this proposition refer to; and what observations would count against it?"--whereas I know what ideas and observations the former proposition goes with.

Page 221

"A new-born child has no teeth."--"A goose has no teeth."--"A rose has no teeth."--This last at any rate--one would like to say--is obviously true! It is even surer than that a goose has none.--And yet it is none so clear. For where should a rose's teeth have been? The goose has none in its jaw. And neither, of course, has it any in its

Page Break 222

wings; but no one means that when he says it has no teeth.--Why, suppose one were to say: the cow chews its food and then dungs the rose with it, so the rose has teeth in the mouth of a beast. This would not be absurd, because one has no notion in advance where to look for teeth in a rose. ((Connexion with 'pain in someone else's body'.))

Page 222

I can know what someone else is thinking, not what I am thinking.

Page 222

It is correct to say "I know what you are thinking", and wrong to say "I know what I am thinking."

Page 222

(A whole cloud of philosophy condensed into a drop of grammar.)

Page 222

"A man's thinking goes on within his consciousness in a seclusion in comparison with which any physical seclusion is an exhibition to public view."

Page 222

If there were people who always read the silent internal discourse of others--say by observing the larynx--would they too be inclined to use the picture of complete seclusion?

Page 222

If I were to talk to myself out loud in a language not understood by those present my thoughts would be hidden from them.

Page 222

Let us assume there was a man who always guessed right what I was saying to myself in my thoughts. (It does not matter how he manages it.) But what is the criterion for his guessing *right*? Well, I am a truthful person and I confess that he has guessed right.--But might I not be mistaken, can my memory not deceive me? And might it not always do so when--without lying--I express what I have thought within myself?--But now it does appear that 'what went on within me' is not the point at all. (Here I am drawing a construction-line.)

Page 222

The criteria for the truth of the *confession* that I thought such-and-such are not the criteria for a true *description* of a process. And the importance of the true confession does not reside in its being a correct and certain report of a process. It resides rather in the special consequences which can be drawn from a confession whose truth is guaranteed by the special criteria of *truthfulness*.

Page 222

(Assuming that dreams can yield important information about the dreamer, what yielded the information would be truthful accounts of dreams. The question whether the dreamer's memory deceives him when he reports the dream after waking cannot arise, unless indeed we introduce a completely new criterion for the report's 'agreeing')

Page Break 223

with the dream, a criterion which gives us a concept of 'truth' as distinct from 'truthfulness' here.)

Page 223

There is a game of 'guessing thoughts'. A variant of it would be this: I tell A something in a language that B does not understand. B is supposed to guess the meaning of what I say.--Another variant: I write down a sentence which the other person cannot see. He has to guess the words or their sense.--Yet another: I am putting a jig-saw puzzle together; the other person cannot see me but from time to time guesses my thoughts and utters them. He says, for instance, "Now where is this bit?"--"*Now* I know how it fits!"--"I have no idea what goes in here,"--"The sky is always the hardest part" and so on--but *I* need not be talking to myself either out loud or silently at the time.

Page 223

All this would be guessing at thoughts; and the fact that it does not actually happen does not make thought any more hidden than the unperceived physical proceedings.

Page 223

"What is *internal* is hidden from us."--The future is hidden from us. But does the astronomer think like this when he calculates an eclipse of the sun?

Page 223

If I see someone writhing in pain with evident cause I do not think: all the same, his feelings are hidden from me.

Page 223

We also say of some people that they are transparent to us. It is, however, important as regards this observation that one human being can be a complete enigma to another. We learn this when we come into a strange country with entirely strange traditions; and, what is more, even given a mastery of the country's language. We do not *understand* the people. (And not because of not knowing what they are saying to themselves.) We cannot find our feet with them.

Page 223

"I cannot know what is going on in him" is above all a *picture*. It is the convincing expression of a conviction. It does not give the reasons for the conviction. *They* are not readily accessible.

Page 223

If a lion could talk, we could not understand him.

Page 223

It is possible to imagine a guessing of intentions like the guessing of thoughts, but also a guessing of what someone is actually *going to do*.

Page 223

To say "He alone can know what he intends" is nonsense: to say "He alone can know what he will do", wrong. For the prediction contained in my expression of intention (for example "When it strikes

Page Break 224

five I am going home") need not come true, and someone else may know what will really happen.

Page 224

Two points, however, are important: one, that in many cases someone else cannot predict my actions, whereas I foresee them in my intentions; the other, that my prediction (in my expression of intention) has not the same foundation as his prediction of what I shall do, and the conclusions to be drawn from these predictions are quite different.

Page 224

I can be as *certain* of someone else's sensations as of any fact. But this does not make the propositions "He is much depressed", " $25 \times 25 = 625$ " and "I am sixty years old" into similar instruments. The explanation suggests itself that the certainty is of a different *kind*.--This seems to point to a psychological difference. But the difference is logical.

Page 224

"But, if you are *certain*, isn't it that you are shutting your eyes in face of doubt?"--They are shut.

Page 224

Am I less certain that this man is in pain than that twice two is four?--Does this shew the former to be mathematical certainty?--'Mathematical certainty' is not a psychological concept.

The kind of certainty is the kind of language-game.

"He alone knows his motives"--that is an expression of the fact that we ask *him* what his motives are.--If he is sincere he will tell us them; but I need more than sincerity to guess his motives. This is where there is a kinship with the case of *knowing*.

Let yourself be *struck* by the existence of such a thing as our language-game of: confessing the motive of my action.

We remain unconscious of the prodigious diversity of all the everyday language-games because the clothing of our language makes everything alike.

Something new (spontaneous, 'specific') is always a language-game.

What is the difference between cause and motive?--How is the motive *discovered*, and how the cause?

There is such a question as: "Is this a reliable way of judging people's motives?" But in order to be able to ask this we must know what "judging a motive" means; and we do not learn this by being told what '*motive*' is and what '*judging*' is.

One judges the length of a rod and can look for and find some method of judging it more exactly or more reliably. So--you say--*what* is judged here is independent of the method of judging it. What length *is* cannot be defined by the method of determining length.--To think like this is to make a mistake. What mistake?--To say "The height of Mont Blanc depends on how one climbs it" would be queer. And one wants to compare 'ever more accurate measurement of length' with the nearer and nearer approach to an object. But in certain cases it is, and in certain cases it is *not*, clear what "approaching nearer to the length of an object" means. What "determining the length" means is not learned by learning what *length* and *determining* are; the meaning of the word "length" is learnt by learning, among other things, what it is to determine length.

(For this reason the word "methodology" has a double meaning. Not only a physical investigation, but also a conceptual one, can be called "methodological investigation".)

We should sometimes like to call certainty and belief tones, colourings, of thought; and it is true that they receive expression in the *tone* of voice. But do not think of them as 'feelings' which we have in speaking or thinking.

Ask, not: "What goes on in us when we are certain that....?"--but: How is 'the certainty that this is the case' manifested in human action?

"While you can have complete certainty about someone else's state of mind, still it is always merely subjective, not objective, certainty."--These two words betoken a difference between language-games.

There can be a dispute over the correct result of a calculation (say of a rather long addition). But such disputes are rare and of short duration. They can be decided, as we say, 'with certainty'.

Mathematicians do not in general quarrel over the result of a calculation. (This is an important fact.)--If it were otherwise, if for instance one mathematician was convinced that a figure had altered unperceived, or that his or someone else's memory had been deceived, and so on--then our concept of 'mathematical certainty' would not exist.

Even then it might always be said: "True we can never *know* what the result of a calculation is, but for all that it always has a quite

definite result. (God knows it.) Mathematics is indeed of the highest certainty--though we only have a crude reflection of it."

But am I trying to say some such thing as that the certainty of mathematics is based on the reliability of ink and paper? *No.* (That would be a vicious circle.)--I have not said *why* mathematicians do not quarrel, but only *that* they do not.

It is no doubt true that you could not calculate with certain sorts of paper and ink, if, that is, they were subject to certain queer changes--but still the fact that they changed could in turn only be got from memory and comparison with other means of calculation. And how are these tested in their turn?

What has to be accepted, the given, is--so one could say--*forms of life.*

Does it make sense to say that people generally agree in their judgments of colour? What would it be like for them not to?--One man would say a flower was red which another called blue, and so on.--But what right should we have to call these people's words "red" and "blue" *our* 'colour-words'?"--

How would they learn to use these words? And is the language-game which they learn still such as we call the use of 'names of colour'? There are evidently differences of degree here.

This consideration must, however, apply to mathematics too. If there were not complete agreement, then neither would human beings be learning the technique which we learn. It would be more or less different from ours up to the point of unrecognizability.

"But mathematical truth is independent of whether human beings know it or not!"--Certainly, the propositions "Human beings believe that twice two is four" and "Twice two is four" do not mean the same. The latter is a mathematical proposition; the other, if it makes sense at all, may perhaps mean: human beings have *arrived* at the mathematical proposition. The two propositions have entirely different *uses.*--But what would *this* mean: "Even though everybody believed that twice two was five it would still be four"?--For what would it be like for everybody to believe that?--Well, I could imagine, for instance, that people had a different calculus, or a technique which we should

not call "calculating". But would it be *wrong*? (Is a coronation *wrong*? To beings different from ourselves it might look extremely odd.)

Of course, in one sense mathematics is a branch of knowledge,--but still it is also an *activity.* And 'false moves' can only exist as the exception. For if what we now call by that name became the rule, the game in which they were false moves would have been abrogated.

"We all learn the same multiplication table." This might, no doubt, be a remark about the teaching of arithmetic in our schools,--but also an observation about the concept of the multiplication table. ("In a horse-race the horses generally run as fast as they can.")

There is such a thing as colour-blindness and there are ways of establishing it. There is in general complete agreement in the judgments of colours made by those who have been diagnosed normal. This characterizes the concept of a judgment of colour.

There is in general no such agreement over the question whether an expression of feeling is genuine or not.

I am sure, *sure*, that he is not pretending; but some third person is not. Can I always convince him? And if not is there some mistake in his reasoning or observations?

"You're all at sea!"--we say this when someone doubts what we recognize as clearly genuine--but we cannot prove anything.

Is there such a thing as 'expert judgment' about the genuineness of expressions of feeling?--Even here, there are those whose judgment is 'better' and those whose judgment is 'worse'.

Correcter prognoses will generally issue from the judgments of those with better knowledge of mankind.

Page 227

Can one learn this knowledge? Yes; some can. Not, however, by taking a course in it, but through 'experience'.--Can someone else be a man's teacher in this? Certainly. From time to time he gives him the right *tip*.--This is what 'learning' and 'teaching' are like here.--What one acquires here is not a technique; one learns correct judgments. There are also rules, but they do not form a system, and only experienced people can apply them right. Unlike calculating-rules.

Page 227

What is most difficult here is to put this indefiniteness, correctly and unfalsified, into words.

Page Break 228

Page 228

"The genuineness of an expression cannot be proved; one has to feel it."--Very well,--but what does one go on to do with this recognition of genuineness? If someone says "Voilà ce que peut dire un cœur vraiment épris"--and if he also brings someone else to the same mind,--what are the further consequences? Or are there none, and does the game *end* with one person's relishing what another does not?

Page 228

There are certainly *consequences*, but of a diffuse kind. Experience, that is varied observation, can inform us of them, and they too are incapable of general formulation; only in scattered cases can one arrive at a correct and fruitful judgment, establish a fruitful connexion. And the most general remarks yield at best what looks like the fragments of a system.

Page 228

It is certainly possible to be convinced by evidence that someone is in such-and-such a state of mind, that, for instance, he is not pretending. But 'evidence' here includes 'imponderable' evidence.

Page 228

The question is: what does imponderable evidence *accomplish*?

Page 228

Suppose there were imponderable evidence for the chemical (internal) structure of a substance, still it would have to prove itself to be evidence by certain consequences which *can* be weighed.

Page 228

(Imponderable evidence might convince someone that a picture was a genuine.... But it is *possible* for this to be proved right by documentary evidence as well.)

Page 228

Imponderable evidence includes subtleties of glance, of gesture, of tone.

Page 228

I may recognize a genuine loving look, distinguish it from a pretended one (and here there can, of course, be a 'ponderable' confirmation of my judgment). But I may be quite incapable of describing the difference. And this not because the languages I know have no words for it. For why not introduce new words?--If I were a very talented painter I might conceivably represent the genuine and the simulated glance in pictures.

Page 228

Ask yourself: How does a man learn to get a 'nose' for something? And how can this nose be used?

Page 228

Pretending is, of course, only a special case of someone's producing (say) expressions of pain when he is not in pain. For if this is possible

Page Break 229

at all, why should it always be pretending that is taking place--this very special pattern in the weave of our lives?

Page 229

A child has much to learn before it can pretend. (A dog cannot be a hypocrite, but neither can he be sincere.)

Page 229

There might actually occur a case where we should say "This man *believes* he is pretending."

Page Break 230

Page 230

If the formation of concepts can be explained by facts of nature, should we not be interested, not in grammar, but rather in that in nature which is the basis of grammar?--Our interest certainly includes the

correspondence between concepts and very general facts of nature. (Such facts as mostly do not strike us because of their generality.) But our interest does not fall back upon these possible causes of the formation of concepts; we are not doing natural science; nor yet natural history--since we can also invent fictitious natural history for our purposes.

Page 230

I am not saying: if such-and-such facts of nature were different people would have different concepts (in the sense of a hypothesis). But: if anyone believes that certain concepts are absolutely the correct ones, and that having different ones would mean not realizing something that we realize--then let him imagine certain very general facts of nature to be different from what we are used to, and the formation of concepts different from the usual ones will become intelligible to him.

Page 230

Compare a concept with a style of painting. For is even our style of painting arbitrary? Can we choose one at pleasure? (The Egyptian, for instance.) Is it a mere question of pleasing and ugly?

Page Break 231

xiii

Page 231

When I say: "He was here half an hour ago"--that is, remembering it--this is not the description of a present experience.

Page 231

Memory-*experiences* are accompaniments of remembering.

Page 231

Remembering has no experiential content.--Surely this can be seen by introspection? Doesn't *it* shew precisely that there is nothing there, when I look about for a content?--But it could only shew this in this case or that. And even so it cannot shew me what the word "to remember" means, and hence *where* to look for a content!

Page 231

I get the *idea* of a memory-content only because I assimilate psychological concepts. It is like assimilating two *games*. (Football has *goals*, tennis not.)

Page 231

Would this situation be conceivable: someone remembers for the first time in his life and says "Yes, now I know what 'remembering' is, what it *feels like* to remember".--How does he know that this feeling is 'remembering'? Compare: "Yes, now I know what 'tingling' is". (He has perhaps had an electric shock for the first time.)--Does he know that it is memory because it is caused by something past? And how does he know what the past is? Man learns the concept of the past by remembering.

Page 231

And how will he know again in the future what remembering feels like?

Page 231

(On the other hand one might, perhaps, speak of a feeling "Long, long ago", for there is a tone, a gesture, which go with certain narratives of past times.)

Page Break 232

xiv

Page 232

The confusion and barrenness of psychology is not to be explained by calling it a "young science"; its state is not comparable with that of physics, for instance, in its beginnings. (Rather with that of certain branches of mathematics. Set theory.) For in psychology there are experimental methods and *conceptual confusion*. (As in the other case conceptual confusion and methods of proof.)

Page 232

The existence of the experimental method makes us think we have the means of solving the problems which trouble us; though problem and method pass one another by.

Page 232

An investigation is possible in connexion with mathematics which is entirely analogous to our investigation of psychology. It is just as little a *mathematical* investigation as the other is a psychological one. It will *not* contain calculations, so it is not for example logistic. It might deserve the name of an investigation of the 'foundations of mathematics'.

Page ix

†1 It was hoped to carry out this plan in a purely German edition of the present work.

Page 2

†1 "When they (my elders) named some object, and accordingly moved towards something, I saw this and I grasped that the thing was called by the sound they uttered when they meant to point it out. Their intention was shewn by their bodily movements, as it were the natural language of all peoples: the expression of the face, the play of the eyes, the movement of other parts of the body, and the tone of voice which expresses our state of mind in seeking, having, rejecting, or avoiding something. Thus, as I heard words repeatedly used in their proper places in various sentences, I gradually learnt to understand what objects they signified; and after I had trained my mouth to form these signs, I used them to express my own desires."

Page 21

†1 I have translated the German translation which Wittgenstein used rather than the original. Tr.

Page 86

†1 The MSS. have: der Reihe $x = 1, 3, 5, 7, \dots$ indem er die Reihe der $x^2 + 1$ hinschreibt.--Ed.

Page 194

†1 *Fact and Fable in Psychology*.

REMARKS ON THE PHILOSOPHY OF PSYCHOLOGY

Volume I

Page i

Page Break ii

Titlepage

Page ii

Ludwig Wittgenstein:

REMARKS ON THE PHILOSOPHY OF PSYCHOLOGY:

VOLUME I

Edited by

G. E. M. ANSCOMBE

and

G. H. von WRIGHT

Translated by

G. E. M. ANSCOMBE

BASIL BLACKWELL

OXFORD

Page Break iii

Copyright page

Page iii

Copyright © Blackwell Publishers Ltd, 1980

First published in 1980

Reprinted 1988, 1990, 1998

Blackwell Publishers Ltd

108 Cowley Road

Oxford OX4 1JF, UK

All rights reserved. Except for the quotation of short passages for the purposes of criticism and review, no part of this publication may be reproduced, stored in a retrieval system, or transmitted, in any form or by any means, electronic, mechanical, photocopying, recording or otherwise, without the prior permission of the publisher.

Page iii

Except in the United States of America, this book is sold subject to the condition that it shall not, by way of trade or otherwise, be lent, resold, hired out, or otherwise circulated without the publisher's prior consent in any form of binding or cover other than that in which it is published and without a similar condition including this condition being imposed on the subsequent purchaser.

British Library Cataloguing in Publication Data

Wittgenstein, Ludwig

Remarks on the philosophy of psychology

Vol. I

1. Cognition 2. Knowledge, Theory of

I. Title II. Anscombe, Gertrude Elizabeth Margaret. III. Wright, Georg Henrik von

153.4 BF311

ISBN 0-631-13061-6

Printed in Great Britain by Athenaeum Press Ltd, Gateshead, Tyne & Wear

This book is printed on acid-free paper

Page Break iv

PREFACE

Page iv

After Wittgenstein had finished Part I of *Philosophical Investigations* in the form in which it was later printed, he was writing remarks from May 1946 to May 1949 in new MS volumes (MSS 130-138), remarks almost exclusively concerned with the nature of psychological concepts. During this period he twice dictated a selection of the MS material to a typist, in late autumn 1947 (TS 229) and in early autumn 1948 (TS 232). For the last third of the MS entries there is no corresponding extant typescript. Probably in the middle of 1949 Wittgenstein put together a MS selection (MS 144), mainly from what he had written since October 1948, but partly also from earlier MS volumes and typescripts. He then had a fair copy of this MS typed out, and it was printed as Part II of *Philosophical Investigations*. This typescript has unfortunately disappeared.

Page iv

What Wittgenstein wrote in MS books 130-138 may with some justification be described as preparatory studies for Part II of the *Investigations*. He cut up the two typescripts 229 and 232 into slips, and preserved in all three hundred and sixty-nine of the fragments for further use. They are printed in the collection *Zettel*. (They amount to more than half of the remarks in that work.) But by far the greater part of the remarks in TSS 229 and 232 and in the MS volumes 137 and 138 have thus far remained unpublished.

Page iv

The editors considered it right to publish the two typescripts 229 and 232 in their entirety in two volumes under the title "Remarks on the Philosophy of Psychology".

Page iv

Typescript no. 229 is here published as the first volume. The underlying MSS cover the time from May 10th 1946 to October 11th 1947. There were two versions of the typescript, one probably copied from the other. Both were marred with many spelling mistakes and other faults. An exact collation with the MS sources was carried out. The MSS for the most part do not contain drawings, and so we have taken them from the corresponding MSS.

Page iv

Mr. André Maury and Mr. Heikki Nyman helped in working over the sources to make an accurate and complete text. Heikki Nyman made the index for the book. The editors would like to take this opportunity of thanking their collaborators for this laborious work.

G. E. M. Anscombe

G. H. von Wright

Page iv

Wittgenstein's spelling is sometimes old-fashioned, sometimes vacillating--and sometimes obviously incorrect. The punctuation also often

departs very much from normal punctuation. Care was necessary in making corrections. In general we have tried to follow the readings of the typescript, e.g. in the case of the initial letters of adjectives functioning substantively. In a few cases only we have chosen to disturb the punctuation of the typescript. We are greatly indebted to Joachim Schulte for helpful advice in correction of the printed text.

I

1. Let's consider what is said about such a phenomenon as this: seeing the figure  sometimes as an F, sometimes as the mirror-image of an F.

I want to ask: what does seeing the figure now this way now that consist in?--Do I actually see something different each time; or do I only *interpret* what I see in a different way?--I am inclined to say the former. *But why?* Well, interpreting is an action. It may consist, e.g., in someone's saying "That's supposed to be an F", or he doesn't say it, but when he copies the sign he replaces it by an F; or he considers: "What may that be? It'll be an F that the writer slipped with". Seeing isn't an action but a state. (A grammatical remark.) And if I have never read the figure as anything but "F", never considered what it might be, then we shall say that I see it as an F; if, that is, we know that it can also be seen differently.

For how have we arrived at the concept of 'seeing this as this'? On what occasions does it get formed, is it felt as a need? (Very frequently, when we are talking about a work of art.) Where, for example, what is in question is a phrasing by the eye or ear. We say "You must hear this bar as an introduction", "You must listen for this mode", but also "I hear the French 'ne... pas' as a negation with two parts to it, not as 'not a step'" etc. Now is it an actual seeing or hearing? Well: that's what we call it; we react with these words in particular situations. And in turn we react to these words with particular actions. [Zettel, 208.]

2. Is it introspection that tells me whether I have to do with a genuine seeing, or rather with an act of interpreting? To start with I must get clear about what I would call a case of interpreting; what it is that tells me whether something is interpreting or seeing.

(Seeing in accordance with an interpretation.) [Z 212.]

3. I should like to say: "I see the figure as the mirror-image of an F" is only an indirect description of my experience. That there is a direct one; namely: I see the figure like *this* (here I point for myself at my visual impression). Whence this temptation here?--There is an important fact here, namely that we are prepared to allow for a number of different descriptions of our visual impression, e.g. "Now the figure is *looking* to the right, now to the left."

4. Suppose we were to ask someone: What similarity is there between this figure and an F? Now one person answers "The figure is a reversed F", and another "It is an F with the horizontals made too long". Are we to say "These two see the figure differently"?

5. Don't I see the figure sometimes this way, sometimes otherwise, even when I don't react with words or any other signs?

But "sometimes this way", "sometimes otherwise" are after all words, and what right have I to use them here? Can I prove my right to you, or to myself? (Unless by a further reaction.)

But surely I know that there are two impressions, even if I don't say so! But how do I know that what I say then, is the thing that I knew? [Z 213.]

6. The familiar face of a word; the feeling that a word is as it were a picture of its meaning; that it has as it were taken its meaning up into itself--it's possible for there to be a language to which all that is alien. And how are these feelings expressed among us? By the way we choose and value words. [Cf. P.I. p. 218f.]

7. It is *easy* to describe the cases in which we are right to say we *interpret* what we see, as such-and-such. [Cf. P.I. p. 212e.]

8. When we interpret, we make a conjecture, we express a hypothesis, which may subsequently turn out false. If we say "I see this figure as an F", there isn't any verification or falsification for that, just as there isn't for "I see a luminous red". This is the kind of similarity that we must look for, in order to justify the use of the word "see" in that context. If someone says that he knows by introspection that it is a case of 'seeing', the answer is: "And how do I know what you are calling introspection? You explain one mystery to me by another." [Cf. P.I. p. 212e.]



9. In different places in a book, a text-book of physics say, we see the illustration: . In the accompanying text what is in question is one time a glass cube, another a wire frame, another a lidless open box, another time it's three boards making a solid angle. The text interprets the illustration every time.

But we can also say that we *see* the illustration now as one thing, now as another.--Now how remarkable it is, that we are able to use

the words of the *interpretation* also to describe what is immediately perceived!

Here at first we should like to reply: This description of the immediate experience by means of an interpretation is only an indirect description. That the truth is this: We can give the figure one time interpretation A, one time interpretation B, one time interpretation C; and there are also three direct experiences--three ways of seeing the figure--A', B', C', such that A' favours interpretation A, B' interpretation B, C' interpretation C. That is why we use interpretation A as a description of the way of seeing which is favourable to it. [Cf. P.I. p. 193f, g.]

10. But what does it mean to say that the experience A' favours interpretation A? What is the experience A'? How is it identified?

11. Let us assume that someone makes the following discovery. He investigates the processes in the retina of human beings who are seeing the figure now as a glass cube, now as a wire frame etc., and he finds out that these processes are like the ones that he observes when the subject sees now a glass cube, now a wire frame etc.... One would be inclined to regard such a discovery as a proof that we actually see the figure differently each time.

But with what right? How can the experiment make any pronouncement upon the nature of the immediate experience?--It puts it in a particular class of phenomena.

12. How is the experience A' identified? How does it come about that I know of this experience at all?

How does one teach anyone the expression of this experience: "Now I am seeing the figure as a wire frame"? Many have learnt the word "see" and never made any such use of it.

Now if I shew our figure to such a one, and tell him "Now just try to see it as a wire frame"--must he understand me? What if he says: "Do you mean anything but that I am to follow the text of the book, which is about a wire frame, and to use the figure as an aid in doing so?" And if he doesn't understand me, what can I do? And if he does understand me, how is that manifested? Isn't it just in this, that he too says he is now *seeing* the figure as a wire frame?

13. Thus the inclination to use that form of verbal expression is a characteristic utterance of the experience. (And an *utterance* is not a *symptom*.)

14. Are there still other utterances of this experience? Wouldn't the following proceeding be conceivable: I put a wire frame, a glass cube, a box, etc. in front of someone and ask him "Which of these things does the figure represent?" He replies "The wire frame".

15. Ought we now to say he saw the figure as a wire frame--though he did not have the experience of seeing it now as this, now as something else?

16. Suppose someone asked "Do we all see a printed F the same way?" Well, one might try the following: We shew various people an F and put the question: "Which way does an F look, to the right or to the left?"

Or we ask: "If you were supposed to compare an F with a face in profile, where would be the front and

where the back?"

But maybe some would not understand these questions. They are analogous to questions like "What colour is the sound a for you?" or "Does a strike you as yellow or white?" etc.

If someone didn't understand this question, if he called it nonsense,--could we say he didn't understand English, or the meanings of the words "colour", "sound", etc.?

On the contrary: it's when he has learnt to understand these words that he can react to those questions 'with comprehension' or 'uncomprehendingly'.

Page 5

17. "Do we all see an F the same way?"--That doesn't yet mean a thing, so long as it isn't settled how we learn 'what way' someone sees it. But if now, e.g., I also say "For me an F looks towards the right and a J towards the left",--does that allow me to say: Whenever I see an F, it looks in this direction, or in any direction? What reason would I have to say anything of the kind?

Page 5

18. Let us assume that the question "Which direction does an F look in?" had never been put--but only this one: "If you had to paint an eye and a nose onto an F and a J, would it look to the right or to the left?" This too would surely be a psychological[[sic]] question. And it would not involve anything about a '*seeing*' this way, or otherwise! What is in question is an *inclination* to do one thing or the other.

Page 5

19. One employment of the concept 'looking in this direction' is, e.g., as follows: One says, perhaps to an architect: "This distribution of the windows makes the façade look *in that direction*." Similarly one uses the expression "This arm interrupts the movement of the sculpture" or "The movement should go like *this*" (here one makes a gesture).

Page Break 6

Page 6

20. The question whether what is involved is a seeing or an act of interpreting arises because an interpretation becomes an expression of experience. And the interpretation is not an indirect description; no, it is the primary expression of the experience.

Page 6

21. But why don't we see that at once, but think rather that there must be an immediate expression here, and that the phenomenon just is too intangible, can't really be described, and in any case we have to grope for an indirect representation to communicate with other people?

We tell ourselves: Unless we supply something extra to the figure in our fancy, we can't possibly have an experience essentially tied up with things that are quite outside the sphere of immediate perception.

One might say, e.g.: "You assert that you see the figure as a wire frame. Do you perhaps also know if it is a copper wire or an iron wire? And why then has it got to be a *wire*?--This shews that the word 'wire' doesn't actually belong essentially to the description of the experience."

Page 6

22. But now let us imagine the following kind of explanation: If one holds one's nose while eating, foods lose all their taste, except for sweet, bitter, salt and sour. So, we want to say, the special taste of bread, say, consists of this 'taste' in the narrower sense and the aroma, which is what gets lost when we don't breathe through our nose. Now why shouldn't there be something like that going on in connection with seeing? Perhaps in this way: The *eye* doesn't distinguish the figure as a wire frame from the figure as a box, etc. That is so to speak the aroma, which the brain supplies to what is seen. On the other hand the eye does distinguish various aspects: it as it were phrases the visual picture; and *one* phrasing is more in accord with *one* interpretation, the other with the other. (More in accord *as a matter of experience*.)

Think, for example, of certain involuntary interpretations that we give *to* one or another passage in a piece of music. We say: This interpretation forces itself on us. (That is surely an experience.) And the interpretation can be explained by purely musical relationships:--Very well, but *our* purpose is, not to explain, but to describe.

Page Break 7

Page 7

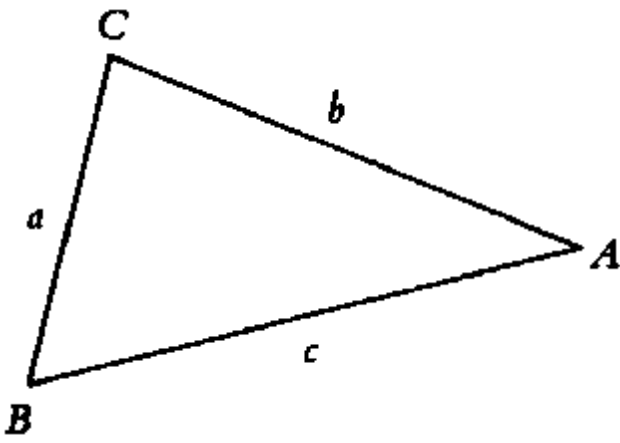

23.

Page 7

See the triangle in such a way that c is the base and C the apex; and now, so that b is the base and B the apex.--What do you do?--First of all:--do you know what you do? No.

"Well, perhaps it is the glance, which first fixes on the 'base' and then goes to the 'apex'. But can you say that your glance couldn't shift in just the same way, in another context, without your having seen the triangle that way?"

Make this experiment too: See the triangle in such a way that (like an arrowhead) it points now in direction A , now in direction B .

Page 7

24. Of whom do we say that he is seeing the triangle as an arrow that points to the right? Of one who has simply learned to use it as such an arrow and has always used it like that? No. Naturally, that does not mean that such a one is said to be seeing it *differently*, or that we wouldn't know how he is seeing it. *Seeing* this way or otherwise doesn't come in here yet.--But what about a case in which I correct someone else and say "What is over there is not an arrow pointing to the right, but one pointing upwards", and now I confront him with some practical consequence of this interpretation. He says: "I always took the triangle as an arrow pointing to the right."--Is a seeing in question here? No: for of course it may mean "When I have encountered this sign I have always followed it *this way*." Someone who says that need not have the least understanding of the question: "But: were you *seeing* it as an arrow pointing to the right?"

Page 7

25. We say that a man sees the triangle now this way, now that, if he says it of himself; if he pronounces, or hears, these words with signs of understanding; but also, if he says, e.g., "Now the triangle is pointing in this direction; before, it pointed in the other direction," and then, when asked whether the triangle has changed its form or position, answers: "It's not like that". And so on.

Page Break 8

Page 8

26. Let us consider the case of the picture of wheels rotating in opposite directions. Firstly, I may again see the movement in the picture as *one* or as the *other* movement. Secondly, I may also *take it* for the one or the other.

Page 8

27. The *somewhat queer* phenomenon of seeing this way or that surely makes its first appearance when someone recognizes that the optical picture in *one* sense remains the same, while something else, which one might call "conception", may change. If I take the picture for this or that, let's say for two wheels turning opposite ways, there is so far no question of a division of the impression into optical picture and conception--Should I say, then, that this division is the phenomenon that interests me?

Or let us ask this: What *reaction* am I interested in? The one that shews that someone takes a bowl for a bowl (and so also the one that shews that he takes a bowl for something else)? Or the one that shews that he observes a change and yet shews at the same time that nothing has altered in his optical picture?

Page 8

28. Another possibility is that I say: I have always taken that for a bowl; now I see that it isn't one--without being conscious of any change of 'aspect'. I mean simply: I now see something different, now have a different visual impression.

Suppose someone shews something to me and asks me what it is. I say: "It's a cube." At which he says "So *that's* how you see it". Would I have to understand these words in any other sense than: "So *that's* what you take it to be"?

Page 8

29. When I contemplate the objects around me, I am not conscious of there being such a thing as a visual conception.

Page 8

30. "I see this figure as a solid angle": why don't you simply accept that as true if, that is, he knows English and is reliable?--I don't doubt that it is the truth. But what he said is a tensed sentence. Not one about the nature of this phenomenon: no, but one saying: this happened.

Page 8

31. The expression of the experience is: "Now I'm seeing it as a pyramid; now as a square with its diagonals."



Now, what is the "it" which I see now this way, now that? Is it the drawing? And how do I know it is the same drawing both times? Do I merely know this, or do I *see* it as well?--How would it be, if it were subsequently proved that the drawing always altered slightly when it was seen as

Page Break 9

something else; or that the optical picture was then slightly different? One line, for example, looks a little heavier, or thinner, then than before.

Page 9

32. Shall I say that the various aspects of the figure are associations? And how does that help me?

Page 9

33. Something about the optical picture of the figure seems to alter here; and then again, nothing alters after all. And I cannot say "A new interpretation keeps on striking me". Indeed it does; but it also incorporates itself straight away in what is seen. There keeps on striking me a new aspect of the drawing--which I see remains the same. It is as if a new garment kept on being put on it, and as if all the same each garment was the same as the other.

One might also say "I do not merely *interpret* the figure, but I clothe it with the interpretation".

Page 9

34. I say to myself: "What is this? What does this phrase say? Just what does it express?"--I feel as if there must still be a much clearer understanding of it than the one I have. And this understanding would be reached by saying a great deal about the surrounding of the phrase. As if one were trying to understand an expressive gesture in a ceremony. And in order to explain it I should need as it were to analyse the ceremony. E.g., to alter it and shew what influence that would have on the role of that gesture.

Page 9

35. I might also say: I feel as if there must be parallels to this musical expression in other fields.

Page 9

36. The question is really: are these notes not the *best* expression for what is expressed here? Presumably. But that does not mean that they aren't to be explained by working on their surrounding[[sic]].

Page 9

37. Is it a contradiction if I say: "This is beautiful and this is not beautiful" (pointing at different objects)? And ought one to say that it isn't a contradiction, because the two words "This" mean different things? No; the two "This's" have the *same* meaning. "Today" has the same meaning today as it had yesterday, "here" the same meaning here and there. It is not here as with the sentence "Mr. White turned white".

"This is beautiful and this is not beautiful" is a contradiction, but it has a use.

Page Break 10

Page 10

38. The basic evil of Russell's logic, as also of mine in the *Tractatus*, is that what a proposition is is illustrated by a few commonplace examples, and then pre-supposed as understood in full generality.

Page 10

39. But isn't it clear that the two 'this's' have different meanings, since they can be replaced by different proper names?--Replaced? "This" just doesn't now mean "A", now "B".--Of course not by itself, but together with the pointing gesture.--Very well; that is only to say that a sign consisting of the word "this" and a gesture has a different meaning from a sign consisting of "this" and another gesture.

But that is of course mere juggling with words. What you are saying is that your sentence "This is beautiful and this is not beautiful" is not a complete sentence, because these words have to have gestures going with them.--But why is it not a complete sentence in that case? It is a sentence of a different kind from, say "The sun is rising"; it has a very different kind of employment. But such are the differences that there are, this is the profusion that there is in the realm of sentences.

Page 10

40. "Scot is not a Scot." If I say this, I mean the first S. as a proper name, the second as a class-name. Is there something different going on in my mind, when I pronounce the two words "S."?--The word functions in the proposition in a different way in the two cases. That would be to make a comparison of the word to a machine-part and of the *sentence* to the machine. Quite ineptly. Rather one might say: the language is the machine, the sentence the machine part. It would then go something like this: This crank has two holes of the same size. With one it is attached to the shaft, while the crank pin sticks into the other. [Cf. P.I. p. 176f.]

Page 10

41. Try to mean the first "S." as a class-name, the second as a proper name! How do you make the attempt? [Cf. P.I. p. 176f.]

Page 10

42. "The concept Scot is not a Scot." Is this nonsense? Well, I do not know what anyone who says that is trying to say, that is, how he is intending to use this sentence. I can think out several uses for it, which are ready to hand. "But you just *can't* use it, nor can you think it, in such a way that the same thing is *meant* by the words 'the concept Scot' and the second 'Scot', as you *ordinarily* mean by these words." Here is the mistake. Here one is thinking as if *this* comparison came into one's mind: words fit together in the sentence, i.e. senseless

Page Break 11

sequences of words may be written down; but the meaning of each word is an invisible *body*, and these meaning-bodies do *not* fit together. ("Meaning it gives the sentence a further dimension.")

Page 11

43. Hence the idea that the sentence can't be thought, for in thought I should have to *fit* the meanings of the words together into a sense, and it doesn't work. (Jigsaw puzzle.)†1

Page 11

44. But isn't contradiction forbidden by the law of contradiction?--At any rate "Non (p and non p)" doesn't forbid anything. It is a tautology. But if we forbid a contradiction, then we are excluding forms of contradiction from our language. We expunge these forms.

Page 11

45. One may have the thought: "How remarkable that the *single* meaning of the word "to feel" (and of the other psychological verbs) is compounded of heterogeneous components, the meanings of the *first* and of the *third* person."

But what can be more different than the profile and the front view of a face; and yet the concepts of our language are so formed, that the one appears merely as a variation of the other. And of course it is easy to give a ground in facts of nature for this structure of concepts. (Heterogeneous things; arrow-head and arrow-shaft.)

Page 11

46. If we can find a ground for the structures of concepts among the facts of nature (psychological and physical), then isn't the description of the structure of our concepts really disguised natural science; ought we not in that case to concern ourselves not with grammar, but with what lies at the bottom of grammar in nature?

Indeed the correspondence between our grammar and general (seldom mentioned) facts of nature does concern us. But our interest does not fall back on these *possible* causes. We are not pursuing a natural science; our aim is not to predict anything. Nor natural history either, for we invent facts of natural history for our own purposes. [Cf. P.I. p. 230a.]

Page 11

47. It is interesting, for example, to observe that particular shapes are not tied to particular colours in our environment; that, for example, we do not always see green in connection with round, red in connection with square. If we imagined a world in which shapes and colours *were* always tied to one another in such ways, we'd find intelligible a system of concepts, in which the fundamental division--shape and colour--did not hold.

Page Break 12

Page 12

Some further examples:

It is important, for example, that we are accustomed to draw with pencil, pen or the like, and that therefore the elements of our representation are strokes and points (in the sense of dots). Had human beings never drawn, but always painted (so that the concept of the *contour* of shapes did not play a big part), if there were a word in common use, let's call it "line", at which no one thought of a stroke, i.e. of something very thin, but always thought only of the boundary of two colours, and if at the word "point" one never thought of something tiny, but only of the intersection of two colour boundaries, then perhaps much of the development of geometry would not have

occurred.

If we only saw one of our primary colours, red say, extremely seldom and only in tiny expanses, if we could not prepare colours for painting, if red occurred only in particular connections with other colours, say only at the very tips of leaves of certain trees, these tips gradually changing from green to red in the autumn, then nothing would be more natural than to call red a degenerate green.

Think of the circumstances under which white and black appear to us as *colours* and on the other hand as the lack of any colour. Imagine its being possible to wash all colours away, and that then the base was always white, and that there was no such thing as white paint.

It is easier for us to reproduce and recognize a pure red, green, etc. from memory, than say, a shade of reddish brown.

Page 12

48. But I am not saying: if the facts of nature were different we should have different concepts. That is an hypothesis. I have no use for it and it does not interest me.

I am only saying if you believe that our concepts are the right ones, the ones suited to intelligent human beings; that anyone with different ones would not realize something that we realize, then imagine certain general facts of nature different from the way they are, and conceptual structures different from our own will appear *natural* to you. [Cf. P.I. p. 230b.]

Page 12

49. 'Natural', not 'necessary'. For is everything that we do a means to an end? Is everything inappropriate, that can't be called a means to an end?

Page 12

50. (On 33) The explanation: "I associate this object with the figure", makes nothing clearer.

Page 12

51. How is "will" actually used? In philosophy one is unaware of having invented a quite new use of the word, by assimilating its use to

Page Break 13

that of, e.g., the word "wish". It is interesting that one constructs certain uses of words specially for philosophy, wanting to claim a more elaborated use than they have, for words that seem important to us.

"Want" is sometimes used with the meaning 'try': "I wanted to get up, but was too weak." On the other hand one wants to say that wherever a voluntary movement is made, there is volition. Thus if I walk, speak, eat, etc., etc., then I am supposed to will to do so. And here it can't mean trying. For when I walk, that doesn't mean that I try to walk and it succeeds. Rather, in the ordinary way I walk without trying to. Of course it can also be said "I walk because I want to", if that distinguishes the ordinary case of walking from that in which I am shoved, or electric currents move my leg muscles.

Page 13

52. Philosophy has tried to fix itself up with a use of the word which presents as it were a more consistent following up of certain features of the ordinary use.

Page 13

53. "The word 'x' has two meanings" means: it has two kinds of use.

Page 13

Ought I to say "If you describe the use of this word in our language, you will see that it has two uses, not just one"?

Page 13

54. Might we not imagine people declaring that the word "bench" always has the same meaning? That a bench is



always something like this:

But that they did, nevertheless, also use the word for a legal institution; but of that they say that since it is a bench, it is something of the kind we have drawn in our picture.

Page 13

55. Have the words "go" and "went" the same meaning?

Have the words "go" and "goest" the same meaning?

Has the word "go"†1 the same meaning in "I go"†1 and in "You go"†1?

Page 13

56. Should I say: "With two different meanings there go two different explanations of meaning"?

57. Imagine a group of sentences in a language each consisting of three signs. The sentences describe the work carried out by a particular man. The first sign (from left to right) is the man's name, the second signifies an activity (such as sawing, boring, filing) the third what is worked on.

Such a sentence might run "a a a". If, that is, "a" is the name of a person, an action, and what is worked on.

58. Now what does it mean to say "The sign 'a' has a different meaning in 'x a y' and in 'a x y'"? It might even be said to have a different meaning according to its *position*. (Like a digit in the decimal system.)

Imagine chess played with pieces all the same shape. One would then always have to remember where a particular piece was at the beginning of the game. And it might be said: "This piece and that have different meanings;" I can't make the same moves with one as with the other. Just so I gather from the "a" in the first position that the matter concerns *this* man (perhaps I point to him); from the one in the second position, that he is doing *this* work, etc. The "a" might occur in three tables in which it is correlated with certain pictures that explain its meaning. And in that case I should look the sign 'a' up in a different table according to its position in order to interpret the sentence.

59. What does it mean "to investigate whether 'f(f)' makes sense when 'f' has the same meaning in both places"?

60. One is looking for something, hasn't found it yet, but knows what one is looking for. But it may also happen that one looks around searchingly and cannot say what one is searching for; finally one lights upon something and says "That's what I wanted". "Looking", it might be called, "without knowing what one is looking for".

61. We might speak of "functional states". (E.g.: Today I am very irritable. If I am told such-and-such today, I keep on reacting in such-and-such a way. In contrast with this: I have a headache the whole day.)

62. How did such an expression as "I believe..." ever come to be used? Did a phenomenon, that of belief, suddenly get noticed? [Cf. P.I. p. 190a.]

63. Did we observe ourselves and discover this phenomenon in that way?

64. Did we observe ourselves and other men and so discover the phenomenon of belief?

65. In the language of a tribe there might be a pronoun, such as we do not possess and for which we have no practical use, which 'refers' to the propositional sign in which it occurs. I will write it like this: I. The proposition "I am ten centimetres long" will then be tested for truth by measuring the written sign. The proposition "I contain four words" for example is true; and so is "I do not contain four words". "I am false" corresponds to the paradox of the Cretan Liar.--The question is: What do people use this pronoun for? Well, the proposition "I am ten centimetres long" might serve as a ruler, the proposition "I am beautifully written" as a paradigm of beautiful script.

What interests us is: How does the word "I" get used in a *language-game*? For the proposition is a paradox only when we abstract from its use. Thus I might imagine that the proposition "I am false" was used in the kindergarten. When the children read it, they begin to infer "If that's false, it's true, so it is false, etc. etc." People have perhaps discovered that this inferring is a useful exercise for children.†1

What interests us is: how this pronoun gets used in a *language-game*. It is possible, though not quite easy, to fill out a picture of a language-game with this word. A proposition like "I contain four words" might, for example, be used as a paradigm for the number four, and in another sense so might the proposition "I do not contain four words". A proposition is a paradox only if we abstract from its use.†1

66. How would people differ from us who were not able, like us, to *see* a triangle now this way, now that?--If we came to a tribe that did not have these experiences, how should we notice this?

How should we notice it, if the people could not *see* depth? So that they were as Berkeley thought we are.



67. How many squares go in a square when the scale in which to take the small square has not been determined? Suppose someone came and said: one can't say for sure how many will go in, but one can at any rate make an estimate!

Page Break 16

Page 16

68. "The expression like the feeling"--the bitter food like the bitter sorrow. "As like as like can be",--how would it be if they were not merely like, but the same?

Page 16

69. "Sorrow and care are similar feelings." Is that an empirical fact?

Page 16

70. Ought I to say: "A rabbit may look like a duck"?

Would it be conceivable that someone who knows rabbits but not ducks should say: "I can see the drawing



as a rabbit and also in another way, although I have no word for the second aspect"? Later he gets to know ducks and says: "That's what I saw the drawing as that time!" Why is that not possible?

Page 16

71. Or suppose someone said: This rabbit has a complacent expression.--If someone knew nothing about a complacent expression--might *something strike* him here, and he later on, having learnt to recognize complacency, say that that was the expression that struck him then?

Page 16

72. The *appropriate* word. How do we find it? Describe this! In contrast to this: I find the right term for a curve, after I have made particular measurements of it.

Page 16

73. I see that the word is appropriate even before I know, and even when I never know, *why* it is appropriate.

Page 16

74. I should not *understand* someone who said that he had seen the picture as that of a rabbit, but had not been able to say so, because at that time he had not been aware of the existence of such a creature.

Page 16

75. Should I say: "The picture-rabbit and the picture-duck look just the same"?! Something militates against that--But can't I say: they look just the same, namely like this--and now I produce the ambiguous drawing. (The draft of water, the draft of a treaty.) But if I now wanted to offer reasons against this way of putting things what would I have to say? That one sees the picture differently each time, if it is now a duck and now a rabbit--or, that what is the beak in the duck is the ears in the rabbit, etc?

Page Break 17

Page 17

76. Imagine the ambiguous picture being used in a strip cartoon. Then it is not possible, for example, that some other animal should meet the duck and take it for a rabbit; but it would be possible for someone in the twilight to take the duck in profile for a rabbit.

Page 17

77. "I can no more see the rabbit and the duck at the same time than I can mean the words 'Weiche Wotan, weiche!' in their two meanings."--But that would not be right; what is right is that it is not natural for us to pronounce these words in order to tell Wotan he should depart, and in saying so to tell him that we prefer our eggs soft boiled.†1 And yet it would be possible to imagine such a use of words.

Page 17

78. The *facts* of human natural history that throw light on our problem, are difficult for us to find out, for our talk passes them by, it is occupied with other things. (In the same way we tell someone: "Go into the shop and buy..."--not: "Put your left foot in front of your right foot etc. etc., then put coins down on the counter, etc. etc.")

Page 17

79. If I do not believe in an inner state of seeing and the other says: "I see...", then I believe that he does not know English, or is lying.

Page 17

80. What has been said, if it is said that anyone who sees the drawing now as a rabbit now as a duck has quite different visual experiences? The inclination to say this becomes very great, if, e.g., one adds a line to the drawing that perhaps emphasizes the mouth of the rabbit, and then sees how this line plays a quite different part in the picture of the duck.--Or think of the facial expression of the rabbit, which completely disappears in the other picture.

At first, for example, I see a haughty face, and then I don't see a haughty face.

And what is done by someone, if he admits that I see something quite different each time?

Page 17

81. "How do I know that I am smiling at *this* facial expression?"

Page Break 18

Page 18

82. "I see a quite particular facial expression, which I call that of the rabbit, and a completely different one which I call that of the duck." Let me merely call one A and the other one B: How could I now explain the meaning of A and B to someone without making any reference to a rabbit and a duck?

It would be possible, e.g. like *this*: I say "A" to him and give an imitation of a rabbit's face with my own face etc.

Page 18

83. "'Seeing *this*' doesn't mean: reacting in *this* way,--for I can see without reacting." Of course. For neither does "I see" mean: I react, nor "he sees": he reacts, nor "I saw": I reacted, etc.

And even if I *said* "I see" whenever I saw, these words wouldn't say "I say 'I see'".

Page 18

84. I point to a particular spot in the picture and say "That is the eye of the rabbit or of the duck." Now how can something in this drawing be an *eye*?

Page 18

85. "Can depth really be seen?"--"Why should one not be able to see depth, when one can see colours and shapes?! The retina's being two-dimensional is no reason for saying the opposite."--Certainly not; but the answer does not meet the problem. The problem arises from this, that the description of the seen, what we call the description of what is seen, is of a different kind, if one time I represent colour and shape, perhaps using a transparency, another time the dimension of depth by means of a gesture or a profile.

Page 18

86. It is unhelpful to remark that the arrangement in the dimension of depth is, like any other, a property of the 'seen'.

Page 18

87. What does it mean to say that the cavity in a tooth that the dentist is probing feels much bigger than it is to the patient? I shew with my fingers, e.g., and say: "I would have thought it was as big as *this*." What do I go by in measuring the distance apart of the fingers?--Do I measure it at all? Can one say: "First, I know how big the cavity strikes me as being, then I shew it with my fingers"? Well, in some cases that could be said, when, for example, I think to myself that the cavity is 5 mm and explain *this* to someone by shewing him the distance--Suppose I were asked: "Did you know how big the diameter struck you as being before you shewed it?"--Here I might reply: "Yes. For if you had asked me earlier, I should have given you this answer."--Knowing something just isn't: thinking a thought.

Page Break 19

Page 19

88. When I say what I know, how is what I say *what* I know?

Page 19

89. What is the description of what I see? (This doesn't mean only: In what words am I to describe what I see?--but also "What does a description of what I see look like? What am I to call by that name?")

Page 19

90. The peculiar feeling that the recurrence of a refrain gives us. I should like to make a gesture. But the gesture isn't really at all characteristic precisely of the recurrence of a refrain. Perhaps I might find that a *phrase* characterizes the situation better; but it too would fail to explain why the refrain strikes one as a joke, why its recurrence elicits a laugh or grin from me. If I could dance to the music, that would be my best way of expressing just *how* the refrain moves me. Certainly there couldn't be any better expression than that.--

I might, for example, put the words "To repeat", before the refrain. And that would certainly be apt; but it does not explain why the refrain makes a strongly comic impression on me. For I don't always laugh when a "To

repeat" is appropriate.

Page 19

91. The 'content' of experience, of experiencing: I know what toothaches are like, I am acquainted with them, *I know what it's like to see red, green, blue, yellow, I know what it's like to feel sorrow, hope fear, joy, affection, to wish to do something, to remember having done something, to intend doing something, to see a drawing alternately as the head of a rabbit and of a duck, to take a word in one meaning and not in another etc.*† I know how it is to see the vowel *a* grey and the vowel *ü* dark purple.--I know, too, what it means to parade these experiences before one's mind. When I do that, I don't parade kinds of behaviour or situations before my mind.--So I know, do I, what it means to parade these experiences before one's mind? And what *does* it mean? How can I explain it to anyone else, or to myself?

Page 19

92. The concept 'word' in linguistics. How does one use "the same word"?

"have" and "had" are the same word.'

'He's saying the same word, once out loud, once silently.'

'Are "bank" (money) and "bank" (river) the same word?'

'Is it the same word "have" both times when one says "I have a house" and "I have built a house"?''

Page Break 20

Page 20

93. Speculation: A tribe that we have brought into subjection, which we want to make into a slave-race. The behaviour, the bearing of these people is of interest to us just for that reason. We want to describe it, to describe various *aspects* of this behaviour. We watch and observe, e.g. pain-behaviour, joy-behaviour etc. Their behaviour also includes the use of a language. And generally it includes such behaviour as is learned, no less than such as is not learned, like a child's crying. Nor do they merely have a language, they have one containing psychological forms of expression.--Ask yourself: How do these get taught to the children of this tribe?--

Now I assume that these people possess expressions like the following: "I have black hair", "He has black hair"; "I have money", "He has money"; "I have a wound", "He has a wound". And now they use this grammatical construction in *psychological* ascriptions.

Page 20

94. "As I heard 'bank' the meaning money-bank came to mind." It is as if a germ of meaning were experienced, and then got interpreted. Now is that an experience?

One might precisely say: "I had an experience which was the germ for this use." That might be a form of expression that was natural to us.

Page 20

95. Having a favourite... is also a movement of thought that one can learn.

Page 20

96. A tribe that we want to enslave. The government and the scientists give it out that the people of this tribe have no souls; so they can be used without scruple for any purpose whatever. Naturally we are interested in their language all the same; for of course we need to give them orders and to get reports from them. We want to know too what they say among themselves, as this hangs together with the rest of their behaviour. But also we must be interested in what in them corresponds to our 'psychological utterances', for we want to keep them capable of work, and so their expressions of pain, of feeling unwell, of depression, of pleasure in life etc. etc. are of importance to us. Indeed, we have also found that these people can be used successfully as experimental objects in physiological and psychological laboratories; since their reactions--including speech-reactions--are altogether those of men endowed with souls. I assume that it has also been found that these automata can be taught our language instead of their own by a method very like our 'instruction'. [Cf. Z 528.]

Page Break 21

Page 21

97. These beings now learn, e.g. to calculate, to calculate on paper or orally. But somehow we bring them to the point of being able to say the result of a multiplication after they have sat still for a while without writing or speaking. When one considers the kind of way in which they learn this 'calculating in the head', and the phenomena that surround it, the picture suggests itself, that the process of calculating is as it were submerged, and goes on *under* the mirror surface of the water. (Think of the sense in which water '*consists*' of H and O.)

Naturally there are various purposes for which we need to have an order of the form "Calculate this in your head"; a question "Have you calculated it?"; and even "How far have you got?"; a statement of the automaton "I

have calculated..."; etc. etc. In short: all that we say among ourselves about calculating in the head, is also of interest to us when they say it. And what goes for calculating in the head also goes for other forms of thinking.--If anyone among us voices the idea that something must surely be going on *in* these beings, something mental, this is laughed at like a stupid superstition. And if it does happen that the slaves spontaneously form the expression that this or that has taken place *in* them, that strikes us as especially comical. [Cf. Z 529.]

Page 21

98. With these beings we also play the game "Think of a number Multiply it by 5--..."--Does that prove that *after all* something has taken place *in* them?-

Page 21

99. And now we observe a phenomenon,--which we might interpret as the expression of the experience: seeing a figure now this way now that. Now we shew them, e.g., a puzzle picture. They find the solution; and then they say something, point to something, draw something etc., and we can teach them our expression: "Now I always see the picture this way." Or they have learnt our language and the ordinary use of the word "to see" and now they invent that form spontaneously.

Page 21

100. What interest, what importance has this phenomenon, this reaction? It may be quite unimportant, quite uninteresting, or again important and interesting. Some people associate certain colours with our vowels; some can answer the question which days of the week are fat and which are thin. These experiences play a very subordinate part in our lives; but I can easily think out circumstances, in which what is unimportant to us would acquire great importance.

Page Break 22

Page 22

101. The slaves also say "When I heard the word 'bank' it meant... to me". Question: Against the background of what technique of language do they say this? For everything turns on that. What had we taught them, what employment of the word "mean"? And what, if anything at all, do we gather from their utterance? For if we can do nothing with it, it might interest us as a curiosity. Let us just imagine human beings who are unacquainted with dreams and who hear our narrations of dreams. Imagine one of us coming to this non-dreaming tribe and gradually learning to communicate with the people.--Perhaps you think they would never understand the word "dream". But they would soon find a use for it. And the doctors of the tribe might very well be interested in our dreams and draw important conclusions from the dreams of these strangers.--Nor can it be said that for these people the verb "to dream" could mean nothing but to tell a dream. For the stranger would use both expressions, "to dream" and "to tell a dream" and the people of our tribe wouldn't be allowed to confuse "I dreamt..." with "I told the dream...". [Cf. Z 530.]

Page 22

102. We ask ourselves: "What interests us about the psychological utterances of human beings?"--Don't see it so much as a matter of course that these verbal reactions do interest us.

Page 22

103. Why does the chemical formula of a substance interest us? "Well, or [[sic, of?]] course its composition interests us."--Here we have a similar case. The answer might also have been "Because its inner nature interests us".

Page 22

104. "You are surely not going to deny that rust and water and sugar have an inner nature!" "If one didn't know it already, science would surely have shewn it beyond cavil."

Page 22

105. Is the hearing or thinking of a word in this or that meaning a *genuine experience*?--How is that to be judged?--What speaks against it? Well, that one cannot discover any *content* for this experience. It's as if one were expressing an experience, but then could not think what the experience really was. As if one could indeed sometimes think of an experience that was simultaneous with the one we are looking for, but what we get to see then is merely a garment, and, where what it clothes should be, there is a vacuum. And then one is inclined to say: "You must not look for *another* content". The content of the experience just is to be described by the *specific expression* (of the

Page Break 23

experience). But that does not satisfy us either. For why do we feel nevertheless that there just is *no* content there?

And is it like that only with the experience of meaning? Isn't it so also with, e.g., that of remembering? If someone asks me what I have been doing in the last two hours, I answer him straight off and I don't read the answer off from an experience I am having. And yet one says that *I remembered*, and that this is a mental process.

Page 23

106. One might almost marvel that one can answer the question "What did you do this morning?"--without looking up historical traces of activity or the like. Yes; I answer, and wouldn't even know that this was only possible through a special mental process, remembering, if I were not told so.

Page 23

107. But there is also such a thing as "I believe I remember that", whether rightly or wrongly--and here there comes into view what is *subjective* about the psychological.

Page 23

108. If I now say that the experience of remembering and the experience of pain are different in kind, that is misleading: for "experiences of different kinds" makes one think perhaps of a difference like that between a pain, a tickle, and a feeling of familiarity. Whereas the difference of which we are speaking is comparable, rather, to that

between the numbers 1 and $\sqrt{-1}$.

Page 23

109. Where do we get the concept of the 'content' of an experience from? Well, the content of an experience is the private object, the sense-datum, the 'object' that I grasp immediately with the mental eye, ear, etc. The inner picture.--But where does one find one needs this concept?

Page 23

110. Why, when I communicate my subjective memory, am I not inclined to say I was describing the content of my experience?

Page 23

111. Of course, when I say "Memories of that day rose up in me" it looks different. Here I am inclined to speak of a content of the experience, and I imagine something like words and pictures which rise up before my mind.

Page 23

112. I can shew someone what a particular pain, an itch, a tingle etc. is, by producing the feeling in him and observing his reaction, the

Page Break 24

description that he gives, etc. But can I do anything like that in the case of memory-experience?--In such a way, that is, that he can now say "Yes, now I know what it is to remember something". Of course, I can teach him what we call "remembering something"; I can teach him the use of these words. But can he then say "Yes, now I have experienced what that is!" ("Yes, now I know what shuddering is!"†1) If he were to say so, we should be astonished, and think "What can he have experienced?" For we experience nothing special. [Cf. P.I. p. 231c.]

Page 24

113. When someone says "Now I know what a tingle is," we know that he knows through his 'expression of the sensation'; he jerks, makes a particular noise, says what we too say in this case, finds the same description apt as we do. [Cf. P.I. p. 231c.]

Page 24

114. And in this way we might actually speak of a feeling "Long, long ago" and *these* words are an expression of the feeling; but not *these*: "I remember that I often met him." [Cf. P.I. p. 231c.]

Page 24

115. "If it passes, then it was not true love." Why *was* it not in that case? Is it our experience, that only this feeling and not that endures? Or are we using a picture: we test love for its *inner* character, which the immediate feeling does not discover. Still, this picture is important to us. Love, what is important, is not a feeling, but something deeper, which merely manifests itself in the feeling.

We have the word "love" and now we give this title to the most important thing. (As we confer the title "Philosophy" on a particular intellectual activity.)

Page 24

116. We confer individual words as we confer already existing titles.

Page 24

117. "A new born child has no teeth."--"A goose has no teeth." "A rose has no teeth."--This last at any rate--one would like to say--is obviously true! It is even surer than that a goose has none.--And yet it is none so clear. For where should a rose's teeth have been? The goose has none in its beak. Nor, of course, has it any in its wings; but that's not what anyone means when he says it has no teeth--Why, suppose one were to say: the cow chews its food and then dungs the

Page Break 25

rose with it, so the rose has teeth in the mouth of a beast. This is not absurd, because one wouldn't have any idea in

advance, where to look for teeth in a rose. ((This hangs together somehow with the problem that the proposition "The earth has existed for more than 100,000 years" has a clearer sense than "The earth has existed for the last five minutes". For if you were to say that, I should ask you: "What observations are you referring to? What observations would go against your proposition? Whereas I probably know the thinking and observations to which the first proposition belongs.)) [Cf. P.I. p. 221h, g.]

Page 25

118. "You see, this is what it's like when one remembers something." This? What?--Can one imagine someone saying: "I shall never forget this experience (namely of remembering)!"?

Page 25

119. Is memory an experience? *What* do I experience? And is it an experience, when the word "bank" means one thing or the other to me?

Again: *What* do I experience?--One is inclined to answer: I saw this or that before me, I imagined it.

Well, do I merely *say* it?--that is, that this word meant this to me--and did *nothing* happen? It was mere words?--Not mere words; and it can also be said that something happened, which corresponded to them--but one cannot *explain* that it wasn't mere words by saying that something corresponding to them happened. For the two expressions mean the same thing.

Page 25

120. The feeling of having been in just the same situation before. I have never had this feeling.

When I see someone I know well, his is a well-known face; it is far more intimately known to me, than when it merely 'strikes me as familiar'. But wherein consists this familiar knowledge? Have I the feeling of familiar knowledge the whole time when I am seeing him? And why does one not want to say that? One would like to say: "I have no special feeling of familiar knowledge, no feeling that corresponds to my familiarity with him." When I say that I know him extremely well, that I have seen him and talked with him countless times, that isn't meant to describe a *feeling*. And what shews that this does not describe a feeling?--If, say, someone were to assert that *he* had such a feeling the whole time he was seeing some intimately known object--or if he says he *believes* he has such a feeling,--should I say I don't believe him?--Or should I say I don't know what sort of feeling that is?

Page Break 26

Page 26

I see someone I know well, and someone asks me whether his face strikes me as familiar. I shall say: no. I shall say that the face is that of a human being I have seen thousands of times. "And do you not have the experience of familiarity--when you do have it with a face you hardly know?"!

How does it come out that I am not expressing a feeling, when I say: Of course his face is familiar to me, it is as familiar as can be?

Page 26

121. Why is it ridiculous to speak of a continuous feeling of familiar acquaintance?--"Well, because you don't feel one." But is *that* the answer?

Page 26

122. A feeling of familiar acquaintance; that would be something like a feeling of well-being. Why does it seem correct to speak of a feeling here, and not there?--Here there occurs to me the special expression of well-being. A cat's purr, say.

Page 26

123. And can I not also imagine a case, in which I should say someone has a constant feeling of familiar acquaintance with an object? Think of someone going round a room in which he had not been for a long time, and enjoying his familiar acquaintance with all the old things? Could one not speak of a feeling of familiarity here? And why?--Do I know this feeling in *myself*? Is *that* why I find that here it makes sense to speak of the feeling?

Page 26

124. I imagine that all his doings have a familiar feel to him.--But how shall I know this?--Well, by his saying it. So he must use certain words, he must, e.g., say "everything feels so familiar," or give some other specific expression of the feeling.

Page 26

125. The feeling of the unreality of one's surroundings. This feeling I have had once, and many have it before the onset of mental illness. Everything seems somehow not *real*; but not as if one *saw* things unclear or blurred; everything looks quite as usual. And how do I know that another has felt what I have? Because he uses the same words as I find appropriate.

But why do I choose precisely the word "unreality" to express it? Surely not because of its sound. (A word of very like sound but different meaning would not do.) I choose it because of its meaning.

But I surely did not learn to use the word to mean: *a feeling*. No; but I learned to use it with a particular meaning and now I use it spontaneously like *this*. One might say--though it may mislead--: When I have learnt the word in its ordinary meaning, then I choose *that* meaning as a simile for my feeling. But of course what is in question here is not a simile, not a comparison of the feeling with something else.

126. The fact is simply that I use a word, the bearer of another technique, as the expression of a feeling. I use it in a new way. And wherein consists this new kind of use? Well, one thing is that I *say*: I have a 'feeling of unreality'--after I have, of course, learnt the use of the word "feeling" in the ordinary way. Also: the feeling is a state.

127. Anger. "I hate..." is obviously the expression of hate, "I am angry" seldom the expression of anger. Is anger a feeling? And why not?--First and foremost: what does someone do, if he is angry? How does he conduct himself? In other words: when does one say that someone is angry? In such cases he learns to use the expression "I am angry". It is the expression of a feeling?--And why *should* it be the expression of a feeling, or of feelings?

128. Then is anger not an experience?--Is clenching my fist, say, an experience, or pronouncing or writing down a sentence?

129. Take the various psychological phenomena: thinking, pain, anger, joy, wish, fear, intention, memory etc.,--and compare the behaviour corresponding to each.--But what does behaviour include here? Only the play of facial expression and the gestures? Or also the surrounding, so to speak the occasion of this expression? And if one does include the surrounding as well,--how is the behaviour to be compared in the case of anger and in that of memory, for example?

130. Isn't this as if someone were to say: "Compare different states of water"--and by that he means its temperature, the speed with which it is flowing, its colour, etc.?

131. The behaviour of humans includes of course not only what they do without ever having learned the behaviour, but also what they do (and so, e.g. *say*) after having received a training. And this behaviour has its importance in relation to the special training.--If, e.g., someone

has learnt to use the words "I am glad" as someone else has learnt to use the words "I am frightened", we shall draw unlike conclusions from like behaviour.

132. "But may he not be frightened, even though he *never* reveals it?" What does this "may" mean? Is it supposed to mean "Does it sometimes happen that someone is frightened without ever saying so?"--No. Rather: "Is there any sense in e.g. that question?"--Or: does it make sense, if a novelist narrates that someone was frightened but never revealed it? Well, it does make sense. But what sense? I mean:--Where and how will such a sentence be used? When I ask "What sense does it make?"--I want someone to answer me not with a picture or a series of pictures, but with the description of situations.

133. "But depression is surely a *feeling*; you surely don't want to say that you are depressed and don't feel it? And where do you feel it?" That depends on what you call "feeling it". If I direct my attention to my bodily feelings, I notice a very slight headache, a slight discomfort in the region of the stomach, perhaps a certain tiredness. But do I mean that, when I say I am severely depressed?--And yet I say again: "I feel a burden weighing on my soul." "Well, I can't express it any differently!"--But how remarkable that I say it that way and cannot express it differently!

134. My difficulty is altogether like that of a man who is inventing a new calculus (say the differential calculus) and is looking for a symbolism.

135. Depression is not a bodily feeling; for we do not *learn* the expression "I feel depressed" in the circumstances that are characteristic of a particular bodily feeling.

136. "But depression, anger, is surely a particular feeling!"--What sort of proposition is that? Where is it used?

137. Uncertainty: whether a man really has this feeling, or is merely putting up an appearance of it. But of course it is also uncertain whether he is not merely putting up an appearance of pretending. This pretence is merely rarer and does not have grounds that are so easily understood.--But what does this uncertainty consist in? Am I really always in some uncertainty whether someone is really angry, sad, glad etc. etc.? No. Any more than whether I have a notebook in

Page Break 29

front of me and a pen in my hand, or whether this book will fall if I let go of it, or whether I have made a miscalculation when I say 25×25 is 625. The following, however, is true: I can't give criteria which put the presence of the sensation beyond doubt; that is to say: there are no such criteria.--But what sort of fact is *that*? A *psychological* one, concerning sensations? One will want to say it resides in the nature of sensation, or of the expression of sensation. I might say: it is a peculiarity of our language-game.--But even if that is true, it passes over a main point: In *certain* cases I am in some uncertainty whether someone else is in pain or not, I am not secure in my sympathy with him--and *no* expression on his part can remove this uncertainty.--In that case I say, e.g.: "He might be pretending this too." But why should he necessarily be pretending? For pretence is only one quite special case of someone's expressing pain and not feeling it. A particular drug might put him into a state in which he 'acts like an automaton', is not pretending, but feels nothing, though he expresses feelings. I am imagining, e.g., that the drug has the effect that some time after a real illness he repeats all the actions of his period of illness, while the objective illness, the causes of pain, for example, have ceased to exist. In this case we have as little sympathy with him as with someone under a narcotic. We say that he repeats all the expressions of pain, etc. purely automatically, but that of course he isn't pretending.

Page 29

138. "I can never *know* what is going on in him; *he* always knows": When one thinks philosophically, one would like to say that. But what situation does this statement correspond to? Every day we hear one man saying of another that he is in pain, is sad, is merry, etc. without a trace of doubt, and we relatively seldom hear that he does not know what is going on in the other. In this way, then, the uncertainty is not so bad. And it also happens that one says "I know that you felt like this then, even if you won't admit it now".

Page 29

139. The picture "He knows--I don't know" is one that makes our lack of knowledge appear in an especially irritating light. It is like when one looks for an object in various drawers, and tells oneself that God knows the whole time *where* it actually is, and that we are searching this drawer quite futilely.

Page 29

140. "Any human knows he is in pain"--and does he also know exactly how severe his pain is?

Page Break 30

Page 30

141. The uncertainty of the ascription "He's got a pain" might be called a constitutional certainty.

Page 30

142. The child that is learning to speak learns the use of the words "having pain", and also learns that one can simulate pain. This belongs to the language-game that it learns.

Or again: It doesn't just learn the use of "He has pain" but also that of "I believe he has pain". (But naturally not of "I believe I have pain".)

Page 30

143. "He can also simulate pain"--that is to say: he can behave as if he had pains without having them. Certainly; and such a proposition underlines a particular picture; but is the employment of "He has pain" influenced by this?

Page 30

144. But how if someone were to say "Having pain and shamming pain are very different states of mind, which might have the same expression in behaviour"?

Page 30

145. So do sham pain and true pain have the same expression? And in that case how does one distinguish them? How do I know that the child I teach the use of the word "pain" does not misunderstand me and so always call "pain" what I call "sham pain"?

Page 30

146. Suppose someone explains the teaching of the word "pain" in this way: when a child behaves in such-and-such a way on particular occasions, I think it feels what I feel in such cases; and if I am not mistaken in this, then the child associates the word with the feeling and uses the word when the feeling reappears.--

This explanation is correct enough; but *what* does it explain? Or: what sort of ignorance does it remove?--It

tells us, e.g., that the person does *not* associate the word with a behaviour or an 'occasion'. So if anyone did not know whether the word "pain" names a feeling or a behaviour, the explanation would be instructive to *him*. It also says that the word is *not* used now for this feeling now for that--as of course might also be the case. [Cf. Z 545.]

Page 30

147. The explanation says that I use the word wrong if I later use it for a *different* feeling. A whole cloud of philosophy condensed into a droplet of symbolic practice. [Cf. P.I. p. 222b.]

Page Break 31

Page 31

148. Why should the words "I believe he is in pain" not be mere lunacy? Somewhat as if someone were to say "I believe my teeth are in his mouth".

Page 31

149. A tribe: the people often pretend, they lie in the road looking ill and in pain; if someone comes to their aid, they attack him. For this behaviour the tribe has a particular word.

Page 31

150. Instead of "It is uncertain whether he is in pain" one might say "Be mistrustful in face of his manifestation of pain".--And how does one do that?

Page 31

151. Believing that someone else is in pain, doubting whether he is, are so many natural kinds of behaviour towards other human beings; and our language is but an auxiliary to and extension of this behaviour. I mean: our language is an extension of the more primitive behaviour. (For our *language-game* is a piece of behaviour.) [Cf. Z 545.]

Page 31

152. I am not certain whether he is in pain."--Suppose someone were to stick a pin into himself whenever he said this, in order to have the meaning of the word "pain" vividly before his mind and to know *what* he was in doubt *about*! Would the sense of his statement be assured by his providing himself with pain while he makes it? Surely he knows now *what* it is he doubts about the other?--But how will he doubt what he now feels, about the other? How will he attach the doubt to his feelings? For what is the route from his pain to the other? For can he really better doubt the pain of the other, if he himself feels pain at the time? Need I myself have a cow in order to be able to doubt whether someone else has one? [Cf. Z 546.]

Page 31

153. So he has true pain; and what he doubts about another, is the possession of *this*.--But how does he do so?--It is as if I were to say to someone: "Here you have a chair; do you see it? Now translate it into French!" [Cf. Z 547.]

Page 31

154. So he has true pain;--and now he knows what he is to doubt about the other. He has the object before him; and it isn't any such thing as 'behaviour'. (But now!) In order to doubt whether the other is feeling pain now, I need the concept of pain; not pain. And it is probably true that this concept might be imparted to me by providing me with pain. [Cf. Z 548.]

Page Break 32

Page 32

155. It would be just as wrong to use an experience of meaning to explain the concept of understanding meaning as to explain reality and unreality by the experience of unreality, or the concept of the presence of a human being by the feeling of a presence. One might just as well try to explain what check is in chess by a check-feeling.

Page 32

156.  "But one can surely see the figure as an arrow and as a bird's foot, even when one never tells anyone." And that in turn means: It makes *sense* to say: Someone saw the figure now this way, now that, without telling anyone.--I don't want to say it makes no sense, but the sense is not clear straight off:--I know, for example, that people talk of a feeling of unreality, they say everything seems unreal to them; and now one says: everything might strike people as unreal even if they had never told anyone. How does one know straight off that it makes sense to say "perhaps everything strikes this person as unreal, although he never speaks of it"?

Of course I have here purposely chosen a very rare experience. For because it is not one of the everyday experiences, one looks more sharply at the use of the words.--I should like to say: In some pressing trouble it makes sense to cry out: "It's all unreal!"--and so one knows that that other statement makes sense too!--Or again: Someone says to me "Everything seems unreal to me". I hardly know what that means--and yet I know already, that it would make sense to say, etc. etc. Now this of course depends on his using this sentence to describe an experience, i.e. on its being a psychological statement.

157. That is to say: when someone manifests a state of mind, he might also have had that state of mind without manifesting it. That is a bit of talk. †1 But what is the purpose of a sentence saying: perhaps N had the experience E but never gave any sign of it? Well, it is at any rate possible to think of an application for the sentence. Suppose, for example, that a trace of the experience were to be found in the brain, and then we say it has turned out that before his death he had thought or seen such and such etc. Such an application might be held to be artificial and far-fetched; but it is important that it is *possible*.

158. If there is such a thing as a temptation to regard the differential calculus as a calculus with infinitely small magnitudes, it's conceivable that in another case there may be an analogous temptation, a still more powerful one--when, that is, it gets nourishment on every side from the forms of language; and one can imagine it becoming irresistible.

159. "I had toothache"--when I say this I don't remember my behaviour, I remember my pain. And how does that happen? A faint copy of the pain comes into my mind?--So is it as if one were ever so slightly in pain? "No; it is another kind of copy; something specific." So is it as if one had never seen a painted picture but only busts, and one said "No, a painting is quite different from a bust, it is a quite different sort of copy". It might be, for example, that one would find it far harder to make it intelligible to a blind man what a painting is than what a bust is.

160. But the word "specific" (or an analogous one), which one would very much like to use here, does not help. It is as little of a resource as the word "indefinable" when one says that the word "good" is indefinable.

What we want to know, to get a bird's-eye view of, is the use of the word "good", and equally that of the word "remember".

For one can't say: "After all, you are *acquainted* with the specific thing, the memory-image." I am not *acquainted with it*--To be sure I may say "I can't describe Mr. N., but I am acquainted with him"; but that means that I recognize him, not that I *believe* I recognize him.

161. Its making sense to say that someone had a feeling, without ever revealing it, hangs together with its making sense to say "I felt this then; I remember it".

The explanation might be as follows: After all, one isn't going to say: "If I had never said that I had pains at that time, then I wouldn't have had them."

162. "I surely know what this *means*: 'He was in pain!'" Does that mean that I can *imagine* it? What would make this imagining important?

It is indeed important that, in order to explain this proposition I can turn to the memory of my own pains at any time, or to summoning pains up in myself, etc.

163. How does anyone learn to call a lump of sugar "sugar"? How, to obey the request "Give me a lump of sugar?" And how does he learn the words "A lump of sugar, please"--i.e. the expression of a wish?! How, to understand the order "Throw!"; and how, the expression of intention "Now I am going to throw"? Well--the grown-ups may perform before the child, may pronounce the word

and straightway throw,--but now the child must imitate *that*. ("But that is the expression of intention only if the child really has the intention in its mind"--But then when does one say that that is the case?)

And how does it learn to use the expression "I was just about to throw"? And how does one know that it was then really in the state of mind that I call "being about to throw"? After such-and-such language games have been taught it, then on such-and-such occasions it uses the words that the grown-ups spoke in such cases, or it uses a more primitive form of expression, which contains the essential relations to what it has previously learnt, and the grown-ups substitute the regular form of expression for the more primitive one.

164. The new (spontaneous, 'specific' is a language-game). [Cf. P.I. p. 224h.]

165. "But weren't there all these appearances--of pain, of wishing, of intention, of memory etc., before there was any

language?" What is the *appearance* of pain?--"What is a table?"--"Well, *that*, for example!" And that is of course an explanation, but what it teaches is the technique of the use of the word "table". And now the question is: What explanation corresponds to it in the case of an 'appearance' of mental life? Well, there is no such thing as an explanation which one can recognize straight away as the homologous explanation.

Page 34

166. It may be asked: Does something always come into my head when I understand a word?! (The following question is similar: "When I look at a familiar object, does an act of recognition always take place?")

Page 34

167. But there is the phenomenon that when a word is heard outside any context--for example--for a fleeting moment it has one meaning, and the next moment another; that if one pronounces the word over and over it loses all 'meaning'; and so on. And here it is a matter of something's *coming into one's head*.

Page 34

168. What should we say about men who didn't understand the words "Now I'm seeing this figure as..., now as..."? Would they be lacking in an important sense; is it as if they were blind; or colour-blind; or without absolute pitch?

Page Break 35

Page 35

169. Well, it is easy to imagine men who could not 'phrase' drawings thus and so; but would they not all the same take a drawing now for this, now for something else? Or am I to assume that in this case they would not say that the optical picture has in an important sense stayed the same? Thus, when the schematic representation of a cube looked now this way now that to them, would they believe that the lines had altered their position?

Page 35

170. Imagine someone who did not like to see a drawing or a photograph, because he says that a colourless human being is ugly. Or there might be someone who found that men, houses, etc. all tiny as they are in pictures, were uncanny or ridiculous. This would certainly be a very queer attitude. ('Thou shalt make thyself no image.')

Think of our reactions towards a good photograph, towards the facial expression in the photograph. There might be people who at most saw a kind of diagram in a photograph, as we consider a map; from it we can gather various things about the landscape; but we can't, e.g., admire the landscape in looking at the map, or exclaim "What a glorious view!"

The 'form-blind' man must be abnormal in this kind of way. [Cf. P.I. p. 205f.]

Page 35

171. How can the non-occurrence of an experience in hearing the word hinder our *calculating* with words, or influence it?

Page 35

172. Imagine people who only think out loud and only imagine by drawing on paper. Or perhaps it would be better to say: who draw, where we imagine. Then the case where I imagine my friend N does not correspond to the case where someone else draws him; rather he must draw him and say or write that it is his friend N.--But suppose he has two friends who are like one another and have the same name? and I ask him "Which did you mean, the clever one or the stupid one?"--He *could* not answer this. But he could answer the question "Which of them does that present?"--In this case the answer is simply a further use of the picture, not a statement about an experience.

Page 35

173. Compare James' idea that the thought is already complete at the beginning of the sentence, with the idea of the lightning speed of thought and the concept of the *intention* of saying such-and-such. That

Page Break 36

the thought is already complete at the beginning of the sentence (and why not at the beginning of the previous one?) means the same as: If someone is interrupted after the first word and you ask him later on "What were you wanting to say then?", he can answer the question at least, he often can. But here too James says something that sounds like a psychological statement and is not one. For, whether the thought was already complete at the beginning of the sentence would surely have to be proved by the experience of individuals. [Cf. Z 1.]

Page 36

174. However, we also often cannot answer the question what we meant to say then. But in this case we say we have *forgotten* it. Would it be imaginable that in such cases people should reply: "I merely said *these* words; how am I to know what would have come after them?"

Page 36

175. If you say "As I heard this word, it meant... for me" you refer to a point of time and to an employment of the word.--The remarkable thing about it is of course the relation to the point of time.

The 'meaning-blind' would lose that relation. [Cf. P.I. p. 175a.]

Page 36

176. And if you say "I was wanting to go on..."--you refer to a *point of time* and to an *action*. [Cf. P.I. p. 175b.]

Page 36

177. If I speak of the essential *references* of the utterance, that is because this pushes the inessential special expressions of our language into the background. The essential references are the ones that would lead us to translate an otherwise unaccustomed expression into the customary one. [Cf. P.I. p. 175c.]

Page 36

178. Suppose someone never said "I was going to do this then" and could not be taught to use such an expression either? It is surely clear that a person can think a lot without thinking that. He can master a great area of language, without mastering this one. I mean: he remembers his expressions, including perhaps that he said such-and-such to himself. So he will say, e.g., "I said to myself 'I want to go there'" and perhaps also "I imagined the house and went on the path that led there". What is characteristic here is that he has his intentions in the form of thoughts or pictures and hence that they would always be replaceable by the speaking of a sentence or the seeing of a picture. The "lightning speed" of thought is missing in him.--But now, is that supposed to mean that he often moves like an automaton; walks in the street, perhaps, and makes purchases; but when one meets

Page Break 37

him and asks "Where are you going?"--he stares at one as if he were sleep-walking?--He won't answer "I don't know" either. Or will his proceedings strike him, or us, as planless? I don't see why!

When I go to the baker, say, perhaps I say to myself "I need bread" and I go the usual way. If someone asks him "Where are you going?" I want to assume that he answers with the expression of intention just as we do.--But will he also say: "As I left the house, I was meaning to go to the baker, but now..."? No; but ought we to say that on this account he set out on his way as it were sleepwalking?

Page 37

179. But isn't it then remarkable that, in all the great variety of mankind we do not meet such people as this? Or are there such people among the mental defectives; and it is merely not sufficiently observed which language-games these are capable of and which not?

Page 37

180. Plato says that thinking is a conversation. If it really were a conversation, then one could only report the words of the conversation and the external circumstances under which it was carried on, but not also the meaning (*Meinung*) that these words then had for the speaker. If someone said to himself (or out loud) "I hope to see N soon", it would make no sense to ask: "And which person of that name did you mean then?" For all that he did was say these words.

But could I not imagine that he, nevertheless, wants to go on in a particular way; so that I could ask him: "And do you now mean someone by this name, and whom?"

And suppose that usually he could go on now, could explain his words--where would be the difference between him and us? He could give a verbal report of any thought-process. So if he said "I just thought of N" and we asked him "*How* did you think of him?" he can always answer us, unless he says he has forgotten.

Page 37

181. If someone says to me "N has written to me", I can ask him "which N do you mean?"--and must he refer to an experience in speaking the name if he is to answer me?--And if he now simply pronounces the name N--perhaps as an introduction to a statement about N,--can't I equally well ask him "Whom do you mean?" and he equally well answer?

Page Break 38

Page 38

182. One does actually often simply pronounce someone's name; perhaps in a sigh. And now someone else asks "Whom did you mean?"

And how will our meaning-blind man act? Will he not sigh like that; or not be able to answer anything to the question; or answer "I mean..." instead of "I meant..."?

Page 38

183. Imagine one of your acquaintances. Now say who it was.--Sometimes the picture comes first and the name after. But does that mean that I guess the name according to whom the picture resembles?--And if the name only comes after, am I to say that the idea of the acquaintance was already there with the picture, or that it was only complete with the name? For I did not infer the name from the likeness of the picture; and that is the very reason why I can say that the idea had already been there with the picture.

184. "I must go to the bank and get some money."--How did you understand that sentence? Need this question mean anything but "How would you explain this sentence, what action to expect when you hear it?" etc? If the sentence is uttered under different circumstances, so that the word "bank" obviously sometimes *means* this, sometimes something else--must something special go on in hearing the sentence if you are to understand it? Don't all *experiences* of understanding get covered up by the use, by the *practice* of the language-game? And that merely means: here such experiences aren't of the slightest interest to us.

185. When I see the milkman coming, I fetch my jug and go to meet him. Do I experience an intending? Not that I knew of. (Any more, perhaps, than I *try* to walk, in order to walk.) But if I were stopped and asked "Where are you going with that jug?" I should express my *intention*.

186. If now I say, e.g. "I got up to go to the milk van,"--is this to be called the description of an experience of intending? And why is that misleading? Is it because there was here no 'expression' of an experience?

187. But if I say "I got up to..., but then I recollected myself and..."--where is the experience here, and *when* did it take place? Was the experience only the 'recollecting myself', 'changing my mind'?

188. I take the milk-jug, go a few steps, then I see that it isn't clean, say "No!" and go the [[sic to?]] the water-tap. Then I describe what happened and name my intentions. Now *didn't* I have these? Of course! But once again: isn't it misleading to call them *experiences*? if, that is, one *also* calls by that name what I said to myself, imagined etc.! (It would also be misleading to call intention a "feeling".)

189. And now the question arises whether for the same reasons it wouldn't be totally misleading to speak of 'form-blindness' or 'meaning-blindness' (as though one were to talk of 'will-blindness', when someone behaves passively). For a blind man just is someone who does not have a *sense*. (The mental defective--e.g.--can't be compared to the blind man.)

190. When I drew the first  it was a half circle; the second was a half S; the third was a whole.

191. "I have no doubt that that often happens."--If you say this in a conversation, can you really believe that in speaking you distinguish between the meanings of the two words 'that'?

192. One might want to make the following objection against the fiction about people who only think out loud: Suppose such a one were to say "As I left the house, I said to myself 'I must go to the baker,'" couldn't he be asked "Did you really *mean* those words? For you might have said them as practice in elocution, or as a quotation, or as a joke, or in order to mislead someone." That is true. But was what he was doing a matter of the experience that accompanied the words? What speaks for such an assertion? Presumably, that the one who is asked may reply "I meant the sentence *like this*" without inferring this from external circumstances.

193. Of course one wants to say that if someone remembers having *meant* these words, he is remembering the experience of a certain *depth*, of a resonance. (If he had not meant it, he wouldn't have had this resonance.) But is that not simply an illusion (like that in which someone believes that he feels thinking in his head)? One uses inappropriate concepts to form the *picture* of the processes. (Cf. James.)

194. Make the following experiment: Say some ambiguous word to yourself ("till"); if you now experience it as a verb, try to hang on to

this experience, so that it lasts.--If you say the word to yourself several times, it loses its meaning for you; and now ask yourself whether, when you are using it as a verb in ordinary speech, the word does not perhaps feel as it does when it has lost its meaning through being often repeated.--You certainly can't testify from your memory that the contrary is true. But one merely finds that *a priori* it can't be otherwise.

195. It is indifferent whether one says that the interpretation of the word 'till' is projected later into the experience

had while pronouncing it. For here there is no difference between projecting and describing.

Page 40

196. One may take a drawing for a real cube; can one also, in the same sense, take a triangle as lying down or standing up--"When I came nearer, I saw that it was only a drawing." But not: "When I looked closer I saw that *this* was the base line and *this* the apex."

Page 40

197. My words "When you began to speak, I thought you meant..." tie up with the beginning of his speech and with an idea that I had then.--And it is of course possible for someone never to do anything like that. But I will assume that at the end he can answer the question "Which N was I speaking of?" And it is of course possible that he would have answered it differently if I had put the question after the very first words of my story. Isn't he then supposed to understand the question: "Did you know right at the beginning whom I was talking about?"--And now if he does not understand such a question--shall we not simply judge him to be mentally defective? I mean: shall we not simply assume that his thinking is not really *clear*, or that he no longer remembers what he was thinking then? That is to say, here we shall ordinarily use a different picture from the one which I was proposing.

Page 40

198. But it is true: with mental defectives we often feel as if they talked more automatically than we do, and if someone were what we called 'meaning-blind', we should picture him as making a less lively impression than we do, behaving more 'like an automaton'. (One also says: "God knows what goes on in his mind", and one thinks of something ill-defined, disorderly.)

Page Break 41

Page 41

199. It might be that when one pronounced a word to some people, they immediately formed some sentence or other with this word, and that others did not, that the former was a sign of intelligence, the latter of dullness.

Page 41

200. What can be adduced against the expressions 'specific psychological phenomenon' or 'irreducible phenomenon'? They are misleading: but what is their source? One wants to say: "If someone is unacquainted with sweet, bitter, red, green, notes and colours, one cannot make the meaning of these words intelligible to him." On the other hand, if someone hasn't yet eaten a sour apple, what is meant can be explained to him. For red is *this*, and bitter *this* and pain *this*. And if one says that, one must now actually exhibit what these words mean; that is, one must point to something red; taste, or make the other taste, something bitter; give oneself or the other pain etc. Not think that one can privately point to pain within oneself. But how in that case will one exhibit what "imagining", "remembering", "intending", "believing" mean? The expression "specific psychological phenomenon" corresponds to that of the private ostensive definition.

Page 41

201. Is it (in the end) an illusion, if I believed that the other's words had this sense for me at *that* time? Of course not! Any more than it is an illusion to believe that one has dreamed something before waking up.

Page 41

202. When I supposed the case of a 'meaning-blind' man, this was because the experience of meaning seems to have no importance in the *use* of language. And so because it looks as if the meaning-blind could not lose much. But it conflicts with this, that we sometimes say that some word in a communication meant one thing to us until we saw that it meant something else. First, however, we don't feel in this case that the experience of the meaning took place while we *were hearing the word*. Secondly, here one might speak of an experience rather of the sense of the sentence, than of the meaning of a word.

Page 41

203. The picture that one perhaps connects with the utterance of the sentence "The bank is far away", is an illustration of *it* and not of one of its words.

Page 41

204. If someone insists that when he hears and understands an order, a piece of information etc., he mostly does not experience anything at all, at least not anything that determines the sense for him--might this

Page Break 42

man not say nevertheless in some form or other that he had taken the first words of the sentence like *this* and later altered the way he took them?--But what would he say that *for*? It might explain a particular reaction on his part. He heard, e.g., that N was dead and believed that this meant his friend N; then he realizes that it is not so. At first he looks upset; then relieved.--And it is easy to see what kind of interest such an explanation may have.

Page 42

205. What am I to say now--that the meaning-blind man is not in a position to react like that? Or that he merely does not assert that he *then* experienced the meaning--and so, that he merely does not use a particular picture?

Page 42

206. Is the meaning-blind man then one who does *not* say: "The whole course of thought was before my mind in a flash"? But is that to say that he can't say "Now I've got it!"--

Page 42

207. "In that place there was no tree, no shrub"--how does this sentence function? Well, "tree" stands for a thing that looks like *this*. Of course, that's what a tree looks like; but is the idea of a word's going proxy for a thing really so easy to understand? If I am planning a garden, I can have a peg go proxy for a tree here. Where the peg stands now, the tree will be set later.--But still, one might say that the word "tree" in a sentence goes proxy there for the picture of a tree (and of course even a tree can be used as that). For in a picture-language one might put the picture in the place of the word "tree", and the word "tree" will in any case be connected with the picture by means of the ostensive definition. In that case, then, it is the ostensive definition that determines what the word '*goes proxy for*'. And now

apply this, e.g. to the word "pain".--But does not the sign "" in a map go proxy for a house? Surely only in so far as a house too might serve as a *sign*! But the sign surely does not go proxy for the house for which it stands.--"Well, it *corresponds* to it."--So when I walk with the map in my hand and come to this house, I point to the place on the map and say "*That's* the house". "The sign goes proxy for the house" would mean: "Because I can't place the house itself on the map, I put this sign instead of it." But what would the house itself be doing on the map anyway? Proxy is something provisional but if the sign *corresponds* to the house, there is nothing provisional here; for it isn't going to be replaced by the house when we get to the house.

Page Break 43

And as the sign never will be replaced by its bearer, one might ask: How can a house be replaced by an ink line?

No: the peg is a substitute for the tree; the picture may be a substitute for the person, when one would rather see him but must be content with the picture; but the sign on the map is not a substitute for the object that it means.

Page 43

208. While I write, do I feel anything in my hand or in my wrist? Not generally. But still, wouldn't it feel different, if my hand were anaesthetized? Yes. And is that now a proof that I *nevertheless* do feel something when I move my hand in the normal way? No, I believe not.

Page 43

209. "I give you my full confidence." If someone who is saying this pauses after the word "you", perhaps I am able to continue; the situation yields what he wants to say. But if to my surprise he now goes on: "a gold watch" and I say "I was prepared for something else"--does that mean: while he was saying the first words I experienced something that may be called that way of taking the words?? I believe that this can't be said.

Page 43

210. Imagine this conversation: He: "I give you--." "I know. But in this case, all the same, you do *not* trust me."--I interrupted him because I knew what he was going to say. But did I necessarily fill out the continuation in thought? When I see a sketch, do I fill it out in my imagination?

Page 43

211. "I found myself going..."
saying..." etc.†1

This description does not *always* apply when I say something, take a path etc.

Page 43

212. Introspection can never lead to a definition. It can only lead to a psychological statement about the introspector. If, e.g., someone says: "I believe that when I hear a word that I understand I always feel something that I don't feel when I don't understand the word"--that is a statement about his peculiar experiences. Someone else perhaps feels something quite different; and if both of them *make correct use of* the word "understand" the essence of understanding lies in this use, and not in what they may say about what they experience.

Page Break 44

Page 44

213. What must the man be called, who cannot understand the concept 'God', cannot see how a reasonable man may use this word seriously? Are we to say he suffers from some *blindness*?

Page 44

214. One suddenly understands, suddenly repeats a word that the other has said. He tells me "It is seven o'clock"; at first I don't react; suddenly I cry out: "Seven o'clock! Then I'm already too late..." What he said had only just reached

my consciousness. But now, what happened, when I repeated the words "Seven o'clock!?" I can give no answer to this that would be of any interest. Only, to repeat, I had just grasped what he had said, and so on; and that gets us no further. Of course the talk (the idea) of a 'specific process' is based on this "Only, to repeat". (The absent minded man who at the order "Right about turn!" turns left about....)

Page 44

215. Does something happen when I understand this word, intend this or that?--Does nothing happen?--That is not the point; but rather: why should what happens within you interest me? (His soul may boil or freeze, turn red or blue: what do I care?)

Page 44

216. A mental defective will certainly *not* say: "When you began to speak, I thought you meant...."--Now it will be asked: Is that because he always understands right at once? Or because he never corrects himself? Or does the same go on in him as in me, and he merely can't express it?

Page 44

217. "When you began to speak, I thought you were going to.... That was why I made the movement... too." So one explains what one did by means of the thoughts that one had at the time. Now do I really think this explanation out only after the event? Didn't I really make this movement because I thought...?--What sort of question is that? Of course the "because" does not relate to a cause.

Page 44

218. "I am going to explain to you why I stood up; it was because I thought you meant...."--Yes, now I understand it!--But wherein lies the importance of this understanding? Well, for example: If the explanation had been another one, I should have had to react differently with words or actions. To that extent his thought is like an action, or a process in his body. The report about this thought is like one about such processes.--What interest have the words "At first I thought you meant..."? Often none. It may be said to disclose his

Page Break 45

world of thoughts. But what purpose does *that* serve? Why isn't this disclosure empty talk, or mere fantasy?

Page 45

219. One might (of course) call the report of such a conception the report of a *tendency*. (James.) But here the experience of a tendency must not be seen under the aspect of an experience which isn't quite complete! As if experiences yielded a coloured picture, and certain colours were laid on in full strength, others merely indicated, i.e. put on much more faintly.

In itself, however, a faint colour is not a hint at a stronger one.

Page 45

220. An event leaves a trace in the memory: one sometimes imagines this as if it consisted in the event's having left a trace, an impression, a consequence, in the nervous system. As if one could say: even the nerves have a memory. But then when someone remembered an event, he would have to *infer* it from this impression, this trace. Whatever the event does leave behind in the organism, it isn't the memory.

The organism compared with a dictaphone spool; the impression, the trace, is the alteration in the spool that the voice leaves behind. Can one say that the dictaphone (or the spool) is remembering what was spoken all over again, when it reproduces what it took?

Page 45

221. The feeling of dependence. How can one *feel* dependent? How can one *feel* 'It doesn't depend on me'? But what a queer expression of a feeling this is anyway!

But if, e.g., every morning one had difficulty in making certain movements at first, in raising one's arm and the like, and had to wait till the paralysis passed off, and that that sometimes took a long time, and sometimes happened quickly, and one could not foresee it or adopt any means of speeding it up--wouldn't that be the very thing to give us a consciousness of dependence? Isn't it the failure of the regular, or the vivid imagination of its failing, that lies at the bottom of this consciousness?

It is the consciousness: "It didn't have to go like that!" When I get up from a chair, I don't ordinarily tell myself "So I can get up". I say it after an illness, perhaps. But someone who did habitually say that to himself, or who said afterwards: "So it worked this time"--of him one might say he had a peculiar attitude to life.

Page Break 46

Page 46

222. Why does one say "He knows what he means"? How does one know that he *knows* it?

If he knows it, but I don't *know* what he means--what would it be like, if I did know it? And suppose I knew it and he didn't? How would someone have to behave for us to say: "He *knows* what the other is experiencing"?

But must there be a case that we should describe in that way if we were consistent? It *isn't* clear that any appearance must be described by the words "A has pains in the body of B".

That is to say: one can indeed say: "Wouldn't that be a consequent application of this expression?" but I may or may not be inclined to call it consequent.

Page 46

223. Remember especially the expression in a dream narrative: "And I knew that..." One might think: 'It's surely remarkable that one can dream that one knew.' One also says: "and in the dream I knew that..."

Page 46

224. Not all that I do, do I do with some intention. (I whistle as I go along etc. etc.) But if I were now to stand up and go out of the house, and then come back inside, and to the question "Why did you do that?" I answered: "For no particular reason" or "I just did" this would be found queer, and someone who often did this with nothing particular in mind would deviate very much from the norm. Would he have to be what is called "feeble minded"?

Page 46

225. Imagine someone of whom one would say: he can never remember an intention except by remembering the expression of an intention.

What we normally do 'with a definite intention' someone might do without any, but it might nevertheless prove useful. And perhaps in such a case we should say that he acted with *unconscious* intention. E.g., he suddenly climbs on a chair and then gets down again. To the question "Why"? he has no answer; but then he reports having noticed this and that from the chair, and that it seems as if he climbed up in order to observe this.

Might a 'meaning-blind' person not behave likewise?

Page 46

226. "When I said 'He is an ass' I was speaking of..." What sort of connexion have these sounds with this man?--Asked, "Whom do you mean?" I shall mention his name, describe him, shew his photograph etc. Is there a further connexion here? One that held

Page Break 47

particularly at the time of the utterance? During the whole time of uttering the sentence, though, or only while I said "he"? No answer!

Page 47

227. The experience during those words--I should like to say--grows naturally towards this explanation.

Page 47

228. But it is surely like this: I shall sometimes say "He is an ass", in conversation perhaps; and if I were asked "Would you have experienced anything different during these words if we had been speaking of N instead of M?" I shall have to grant that this need not be the case. On the other hand it sometimes seems to me as if I had an experience, while pronouncing the words, that pertains unambiguously to *him*.

The experiences while speaking seems to be connected intimately with *him*.

Page 47

229. "Of course I was thinking of him: I saw him before me!"--but I didn't *recognize* him from my picture of him.

Page 47

230. I suddenly say "He is an ass". A: "Whom did you mean?" I: "N." A: "Did you think of him while you were saying the sentence, or only when you gave the explanation?"--I might now reply that my words had been the terminus of a rather long course of thought. I had already been thinking of N the whole time. And could I now say: the words themselves were not tied up with him through any special experience, but the whole course of thought was? Thus I might easily have meant someone else by those words, and who *was* their reference was a matter of what preceded them.

In order, however, to be able to say that I was speaking of him, meant him, thought of him, must I really be able to remember an experience that unconditionally ties up with him? So might it not perhaps always strike one as if *nothing* had happened while my words were going on, that could only point to him? So I am imagining that I am always *conscious* that my images are ambiguous. At the same time however--this is what I am assuming--I still say "I meant...". But is this not a contradictory assumption? No: for that really is how things are. I say "I meant...": *that* is how I go on.

Page 47

231. I was speaking to my neighbours about their doctor; as I did so a picture of this man came into my mind--but I had never seen him, merely knew his name, and perhaps formed a picture of him from the

Page Break 48

name. How can this picture characterize my speaking of *him*? And yet this is how it struck me, till I recalled that I

don't know at all what the man looks like. So his picture represents him for me not a whit better than does his name.

Page 48

232. If I compare the coming of the *meaning* into one's mind to a dream, then our talk is ordinarily dreamless.

The 'meaning-blind' man would then be one who would always talk dreamlessly.

Page 48

233. And one really can ask: What do his dreams matter to me? Why need I be interested in what he dreams and whether he dreams while he speaks to me or hears me?--Naturally that does not mean that these dreams can never interest me. But why should they be the most important thing in linguistic traffic?

Page 48

234. The use of the word 'dream' here is useful, but only if one sees that it still conceals an error within itself.

Page 48

235. "I thought the whole time that you were talking about...."--Only how *was* it?--Surely not otherwise, than if he really had been speaking of that man. My later realization that I understood him wrong does not alter anything about what happened as I was understanding the words.--

If, then, the sentence "At that point I believed that you meant..." is the report of a 'dream', that means that I *always* 'dream' when I understand a sentence.

Page 48

236. We also say "I assumed you were talking about..." and that sounds still less like the report of an experience.

Page 48

237. "I thought you were speaking of... and wondered at your saying... of him."--This wondering in turn is in like case: Here too we again have the feeling as if it took the pronouncing of this thought to fill out the rudimentary experience.

Page 48

238. Well, it is surely true! For sometimes, when I say "I thought..." I can report that I *did* say these words to myself out loud or silently; or that I used, not these but other words, of which the present ones reproduce the *gist*. *This does surely sometimes happen!* In contrast with this, however, is the case in which my present expression is not the *reproduction* of anything. For it is a 'reproduction' only if there are rules of projection making it one.

Page Break 49

Page 49

239. Someone who was unable to say: the word "till" may be a verb and a conjunction, or to frame sentences in which it is the one or the other--such a one could not master simple school exercises. But what a school child is not required to do is to take the word outside any context in this way and that, or to report how he has taken it. [Cf. P.I. p. 175b.]

Page 49

240. I should like to say: conversation, the application and further interpretation of words flows on and only in this current does a word have its meaning. "He has left."--"Why?" What did you mean as you pronounced the word "Why"? What did you *think* of?

Page 49

241. "I thought you were meaning *him*"--Now, that does not mean the same as "I think you meant him". Don't let the comparison with another use of the past tense confuse you.

Page 49

242. We play this game: There are pictures here and words are pronounced and we have to point to the picture corresponding to the word. Among the words there are also ambiguous ones. At the word... only one meaning occurs to me and I point to a picture, later only another one and I point to another picture. Will the meaning-blind man be able to do this? Of course.--But how about *this*? A word is mentioned, one of its meanings occurs to me. I do not say it, but look for the picture. Before I have found it, I am struck by a further meaning of the word; I say: "A second meaning has just occurred to me." And then I explain: "First *this* meaning occurred to me, and afterwards that one." Can the meaning-blind do *that*?--Can't he say he knows the meaning of the word but isn't saying it? Or can't he say that it has just *occurred* to him but that he isn't saying it?--It strikes me that he can say both. But in that case surely also: "As you said the word, *this* meaning occurred to me." And now why not "When I said that word I meant it at first in *this* meaning."?

Page 49

243. It's as if the word that I understand had a definite slight aroma that corresponds to my understanding of it. As if two familiar words were distinguished for me not merely by their sound or their appearance, but by an atmosphere as well, even when I don't *imagine* anything in connexion with them.--But remember how the names of famous poets and composers seem to have taken up a peculiar meaning into themselves. So that one can say: the names

"Beethoven" and "Mozart" don't merely sound different; no, they are also accompanied by a different *character*. But if you had to describe this

Page Break 50

character more closely--would you point to their portraits, or to their music?

And now the meaning-blind man again: He would not feel that the names, when heard or seen, were distinguished by an imponderable Something. And what would he have lost by this?--And yet, when he hears a name, first *one* bearer of it, and then other, may occur to him.--

Page 50

244. I said, the words "Now I can do it!" don't express an *experience*. Any more than these: "Now I am going to raise my arm."--But why don't they express any experience, any feeling--Well, how are they used? Both, e.g., are preliminary to an action. The fact that a statement makes reference to a point of time, at which time, however, nothing that it means, nothing of which it speaks, happens in the outer world, does not shew us that it spoke of an experience.

Page 50

245. Think of children putting up their hands in class when they know the answer to a question. Must one of them have said the answer silently to himself, for putting up his hand to make sense? *What* must have gone on in him for this?--Nothing. But it is important that he ordinarily *gives* an answer when he has put up his hand; and that is the criterion for his *understanding* putting up one's hand. [Cf. Z 136a.]

Page 50

246. "The words 'the rose is red' are senseless if the word 'is' has the meaning of 'is the same as'." We have the idea that if someone tried to pronounce the words "the rose is red" with these meanings for the words, he could not but get stuck in thinking it. (As also, that one cannot think a contradiction, because so to speak the thought collapses for one.)

One would like to say: "You can't mean these words like this and still connect a sense with the whole." [Cf. P.I. p. 175c.]

Page 50

247. Could one say that a meaning-blind man would reveal himself in this: One can have no success in saying to such a man: "You must hear this word as..., then you will say the sentence properly." That is the direction one gives someone in playing a piece of music. "Play this as if it were the answer"--and one perhaps adds a gesture.

But how does anyone translate this gesture into playing? If he understands me, he now plays it more as I want him to.

But could you not give just such a direction but using the words "louder", "softer", "quicker", "slower"? No: I could not. For even if he *does* now play this note louder, that one more softly, I don't even

Page Break 51

realize it. In the same way I can also tell him "Make a crafty face", and I would know if he had made one, without being able to describe the geometrical alterations of the face beforehand, or afterwards.

Page 51

248. When one asks "Is experiencing meaning analogous to experiencing a mental image?", one means: isn't the difference simply that of a different *content*? Now, what is the content of the experience of imagining? "It is *this*"--but here I must point to a picture or a description.--"In both of these cases one has an experience" (one would like to say)--"Only it's different. A different content is presented to consciousness--stands before it." And this is of course a very misleading picture. For it is the illustration of a turn of speech and it explains nothing. One might as well try to explain the chemical symbolism of a formula by drawing pictures in which the elements were represented as people who stretch out their hands to one another. (Illustrations of the alchemists.) [Cf. P.I. p. 175e.]

Page 51

249. If someone says he has had an image of a shining gold ball, we shall understand him; but not if he says that the ball was hollow. But in a dream a man might see a ball and *know* it was hollow.

Page 51

250. The direction: "Wie aus weiter Ferne"†1 in Schumann. Must everyone understand such a direction? Everyone, for example, who would understand the direction "Not too quick"? Isn't the capacity that is supposed to be absent in the meaning-blind one of this kind?

Page 51

251. Can one keep hold of the understanding of a meaning, as one can keep hold of a mental image? So if a meaning of the word suddenly strikes me--can it also stand still before my mind? [Cf. P.I. p. 176b.]

Page 51

252. "The whole plan came before my mind in a flash and stayed still like that for one minute." Here one would like to think that what stayed still can't be the same as what flashed upon one. (As one can't extend a diphthong.) [Cf. P.I. p. 176c.]

Page 51

253. For if it happened that I said "Now I have it!" (i.e. a sudden start), of course one can't talk about this as staying still.

Page Break 52

Page 52

254. "Yes, I know the word. It's on the tip of my tongue.--"Here the idea forces itself on one, of the gap which James speaks of, which only this word will fit into, and so on.--One is somehow as it were already experiencing the word, although it is not yet there.--One experiences a *growing* word.--And I might of course also say that I experienced a growing meaning, or growing explanation of meaning.--Only it is queer that we don't want to say that there was something there, which then grew up into this explanation. For when you 'put your hand up' you say you already know it.--Very well; but you might also say "Now I can say it", and whether this *ability* grows into a *saying* is something you don't know. And what if it were now said "The saying is the fruit of this ability, if it grew out of this ability"?

Page 52

255. When I *was going* to say it, *was able* to say it, I had not yet *said* it.

Page 52

256. Of course there is something wrong too about the explanation that the meaning or its explanation has grown out of a certain germ. In fact we do not perceive such a growth; or at any rate only in very rare cases. And this explanation springs from the tendency to explain instead of merely describing.

Page 52

257. Mere description is so difficult because one believes that one needs to fill out the facts in order to understand them. It is as if one saw a screen with scattered colour-patches, and said: the way they are here, they are unintelligible; they only make sense when one completes them into a shape.--Whereas I want to say: Here *is* the whole. (If you complete it, you falsify it.)

Page 52

258. Of course the *meaning* occurred to me *then!* Not at the time when I reported it, nor in the interval.

This just is what one calls it: This just is the way we use the words "The meaning occurred to me" ("in this so-called twentieth century"†1).

Page 52

259. "The meaning is surely not something that one can experience!"--Why not?--The meaning isn't a sense-impression. But what are sense-impressions? Something like a smell, a taste, a pain, a noise etc. But what is 'something like' all these things? What is common to them? This question cannot of course be answered by immersing oneself in these sense-impressions. But one might ask this: "In what

Page Break 53

circumstances shall we say that someone has a kind of sense-impression that we lack?"--We say for example of beasts, that they have an organ with which they perceive such-and-such, and such a sense-organ need not be similar to ours.

Page 53

260. Could a kind of sense perception be imagined, through which we grasped the form of a solid body, the *whole* form, not just what can be seen from a certain point of view? Such a person would, e.g., be able to model a body in clay without walking round it or touching it.

Page 53

261. Is it the multiplicity of the possible explanations of a meaning that lies at the bottom of our not experiencing a meaning 'in the same sense' as a visual image?

Page 53

262. What makes my image of him into an image of *him*?--What makes this portrait into *his* portrait? The intention of the painter? And does that mean: his state of mind?--And what makes a photograph into a picture of *him*? The intention of the photographer? And suppose a painter had the intention of drawing N from memory, but, guided by forces in his unconscious, draws an excellent picture of M.--Would we now call it a bad picture of N? And imagine people trained in the drawing of likenesses who draw the person sitting in front of them 'mechanically'. (Human

reading-machines.)

And now--what makes my image of him into an image of *him*? Nothing of what holds for a portrait holds for the image. The *question* makes a mistake. [Cf. P.I. p. 177.]

Page 53

263. If the meaning has struck you, and you have not *forgotten* it again, you can now use the word in this way.

If the meaning has occurred to you, you *know* it now, and its occurring to you was simply the beginning of knowing. Here there is no analogy with the experiencing of a mental image. [Cf. P.I. p. 176e.]

Page 53

264. How is it, though, that when pointing to a particular figure I tell myself that I should like to call *this* such-and-such ('x')? I may even say the ostensive definition "'x' means this" out loud to myself. But I must surely also understand it myself! So I must *know* how, according to what technique, I think of using the sign "x".--If someone asks me, say, "Do you know *how* you are going to use the word?" I shall answer: yes.

Page Break 54

Page 54

265. How about religion's teaching that the soul can exist when the body has disintegrated? Do I understand what it teaches? Of course I understand it--I can imagine a lot here. (Pictures of these things have been painted too. And why should such a picture be only the incomplete reproduction of the spoken thought? Why should it not perform the *same* service as what we say? And this service is the point.) [Cf. P.I. p. 178.]

Page 54

266. But you aren't a pragmatist? No. For I am not saying that a proposition is true if it is useful.

The usefulness, i.e. the use, gives the proposition its special sense, the language-game gives it.

And in so far as a rule is often given in such a way that it proves useful, and mathematical propositions are essentially akin to rules, usefulness is reflected in mathematical truths.

Page 54

267. The expression of soul in a face. One really needs to remember that a face with a soulful expression can be *painted*, in order to believe that it is merely shapes and colours that make this impression. It isn't to be believed, that it is merely the *eyes*--eyeball, lids, eyelashes etc.--of a human being, that one can be lost in the gaze of, into which one can look with astonishment and delight. And yet human eyes just do affect one like this. "From which you may see...."

Page 54

268. Do I *believe* in a soul in someone else, when I look into his eyes with astonishment and delight?

Page 54

269. The proposition "if p, then q", as, e.g. "if he comes, he will bring something", is not the same as " $p \supset q$ ". For the proposition "if p then q" can go into the subjunctive, but the proposition " $p \supset q$ " cannot.--If someone replies to the proposition "If he comes,..." with "that's not true", he doesn't mean to say "He will come and not bring anything" but rather: "He *may* come and not bring anything."

From " $p \supset q$ " there does not follow: "if p then q"; for I can very well assert the former (I know, e.g. that $\sim p \cdot \sim q$ is the case) and deny the second proposition.

Page 54

270. Am I now to say that the proposition "If... then..." is either true, or false, or undecided? (So the law of excluded middle is not valid?)

Page Break 55

Page 55

271. Another answer to the statement "If he comes, he will bring something" is: "Not necessarily."--Also: "That doesn't follow."--One may also say "There isn't that connexion."--Russell said that when one says "If... then..." one ordinarily means not material but formal implication; but that is not correct either. "If... then..." can't be reproduced in expressions belonging to Russellian logic.

Page 55

272. One may, however, very well say that the proposition "If... then..." is either true, or false, or undecided.--But on what occasion will one say this? I think: as an introduction to a further exposition. One treats the matter under these three headings. I divide the field of possibilities into three parts.

It will perhaps now be said: a *proposition* divides it into *two* parts. But why? Unless that is part of the definition of a proposition. Why shouldn't I also call something a proposition that makes a three-fold division?

Page 55

273. Now take a twofold division. I say: "Either he comes, or not. If he comes, then..., if he doesn't come, then..."

May I not apply this treatment to the proposition "If... gets into contact with... there will be an explosion"? If someone has asserted this--may I not reply "Either you are right about that or not: if it is as you say, then...; if not, then..."?

Page 55

274. The law of excluded middle does not say, as its form suggests: There are only these two possibilities, Yes and No, and no third one. But rather: "Yes" and "No" divide the field of possibilities into two parts.--And that of course need not be so. ("Have you stopped beating your wife?")

Page 55

275. 'Wish is a stance of the mind, the soul, in relation to an object.' 'Wish is a state of mind that relates to an object.' In order to make this more intelligible, one thinks perhaps of yearning, and of the object of our yearning's being before our eyes and that we look at it longingly. If it is not there in front of us, perhaps its picture goes proxy for it, and if there is no picture there, then an image. And so the wish is a stance of the soul towards an image. But one really always thinks of the stance of the body towards an object. The stance of the soul to the image is just what one might represent in a picture: the man's soul, as

Page Break 56

it leans with gestures of longing towards the picture (an actual picture) of an object.

Page 56

276. And in this way of course one might also represent someone in whose bearing there is no kind of expression of the wish, but whose soul has this longing.

Page 56

277. "The sentence 'If only he would come' may be laden with our longing."--What was it laden with there? It is as if a weight were loaded on to it from our spirit. I should indeed like to say all of that. And doesn't it matter, that I want to say that?

Page 56

278. Doesn't it matter that I want to say that? Isn't it important? Is it not important that for me hope lives in the *breast*? Isn't this a picture of one or another important bit of human behaviour? Why does a human being believe a thought comes into his head? Or, more correctly, he does not *believe* it; he lives it. For he clutches at his head; he shuts his eyes in order to be alone with himself in his head. He tilts his head back and makes a movement as a sign that nothing should disturb the process in the head.--Now are these not important kinds of behaviour?

Page 56

279. And if the picture of the thought in the head can force itself upon us, why not much more that of thought in the soul? [Cf. P.I. p. 178f.]

Page 56

280. What better picture of believing could there be, than the human being who, with the expression of belief, says "I believe..."?

Page 56

281. The human being is the best picture of the human soul. [Cf. P.I. p. 178g.]

Page 56

282. It is, of course, important that a man wanting an apple can easily be represented in a picture of desire without putting words of desire into his mouth--but that the conviction that something is thus and so cannot be so represented.

Important, because it shews the difference, the essential difference, between psychological phenomena; and the kind of way this difference is to be described.

Page 56

283. Why did I say "essential difference"? Is it a difference like that between carbon, gravitation, the velocity of light and ultra-violet rays? All of which are 'objects' treated of by natural science.--

Page Break 57

Page 57

284. Suppose we are talking of the phenomena we get in connection with human speech. We might be interested in: the speed of talk, the change of intonation, the gestures, the length or shortness of sentences etc. etc.--Now when one says of a human being that he has a mental life: he thinks, wishes, fears, believes, doubts, has images, is sad, merry etc.--is that analogous to: he eats, drinks, speaks, writes, runs,--or analogous to: he moves now fast, now slow, now towards a goal, now without any goal, now continuously, now in jerks?

Page 57

285. Think of what may be called the character of a line, and of all that must be called a description of its character.

What a lot of things one may ask, if one is interested in the character of a line!

Page 57

286. Imagine we were observing the movement of a dot, say a black dot on a white paper surface. Important conclusions of every conceivable kind might be drawn from the character of the movements. But what a host of different things we might observe!--Whether the dot moves uniformly or non-uniformly; whether its velocity alters periodically; whether it alters continuously or in jerks; whether the dot describes a closed line; how close this gets to being a circle; whether the dot describes the line of a wave and what its amplitude and wave length are; and innumerable other things. And any of these might be the one thing that interested us. We might, e.g., be indifferent to everything about this movement except the number of angles of the path in a definite time. And that means that if what interests us is not just a single characteristic, but rather many, then any one of them may yield us special information quite different from all the rest. And that's how it is with the behaviour of human beings, with the various characteristics of this behaviour, which we observe. [Cf. P.I. p. 179a.]

Page 57

287. So does psychology deal with behaviour (*say*), not with human states of mind? If someone does a psychological experiment--what will he report?--What the subject says, what he does, what has happened, to him in the past and how he has reacted to it.--And not: what the subject thinks, what he sees, feels, believes, experiences?--If you describe a painting, do you describe the arrangement of paint strokes on the canvas--and *not* what someone looking at it *sees*?

But now how about this: The observer in the experiment will sometimes say: "The subject said 'I feel...'", and I had the impression

Page Break 58

that this was true."--Or he says: "The subject seemed tired." Is that a statement about his behaviour? One would perhaps like to say: Of course, what else should it be?--It may also be reported: "The subject said 'I am tired'"--but the cash value of these words will depend on whether they are plausible, whether they were repeating what someone else said, whether they were a translation from French, etc.

Now think of this: I recount: "He made a dejected impression." I am asked: "What was it that made this impression on you?" I say: "I don't know."--Can it now be said that I described his behaviour? Well, can one not say I have described his face if I say "His face changed to sadness"? Even though I cannot say what spatial alterations in the face made this impression?

It will perhaps be replied: "If you had looked closer, you would have been able to describe the characteristic changes of colour and position." But who says that I or anyone could do this? [Cf. P.I. p. 179b.]

Page 58

288. Once more: When I report "He was put out", am I reporting a behaviour or a state of mind? (When I say "The sky looks threatening", am I talking about the present or the future?) Both. But not side by side; rather one in one sense, the other in another. But what does that mean? (Is this not mythology? No.) [Cf. P.I. p. 179c.]

Page 58

289. It is here quite as it is with talk of physical objects and sense-impressions. We have *two* language-games, and their mutual relations are complicated. If one tries to describe these relations in a simple fashion, one goes wrong. [Cf. P.I. p. 180c.]

Page 58

290. Suppose I describe a psychological experiment: the apparatus, the questions of the experimenter, the answers and actions of the subject. And then I say: all that is a scene in such-and-such a play. Now all is altered. So it will be said: If this experiment were described in the same way in a book on psychology, in that case the description of the behaviour of the subject would be understood as expression of the state of mind, because one *presupposes* that the subject is speaking the truth, is not pulling our legs, has not learnt the answers by heart.--So we make an assumption? [Cf. P.I. p. 180a.]

Page Break 59

Page 59

291. The nurse says to the doctor "He's groaning"--one time she means to say "He is in severe pain"; another "He's groaning--although there's nothing wrong"; another "He's groaning; I don't know whether he is in pain or is merely making this noise."

We form a presupposition?--We *use* the statement differently each time.

Page 59

292. "Of course the psychologist reports the words, the behaviour, of the subject, but surely only as signs of mental processes."--That is correct. If the words and the behaviour are, for example, learned by heart, they do not interest

the psychologist. And yet the expression "as signs of mental processes" is misleading, because we are accustomed to speak of the colour of the face as a sign of fever. And now each bad analogy gets explained by another bad one, so that in the end only weariness releases us from these ineptitudes.

Page 59

293. Imagine someone saying: any familiar word already has an aura, a 'corona' of faintly indicated uses surrounding it. Much as if the principal figures in a painting were surrounded with faint, misty pictures of proceedings in which these figures play a part.--Now, let's just take this assumption seriously!--Then it comes out that it's inadequate to explain *intention*.

For if it is like this, that the possibilities of employment of an expression come before our minds in half shades as we hear it or say it--if it is like this, then that holds for us. But we communicate with others, without ever having asked them whether they have these experiences too. [Cf. P.I. p. 181a.]

Page 59

294. And what about the continuous coming to be and passing away in the domain of our consciousness? Well, how is it: is that experienced, or can it not be imagined otherwise at all? Here is an unclarity.

Page 59

295. I know my way about in a room: that is, without needing a moment's reflection, I can find the door, open and shut it, use any piece of furniture, I don't have to look for the table, the books, the chest of drawers or think what can be done with them. That I know my way around will come out in the freedom with which I move about in the room. It will also be manifested in an absence of astonishment or doubt. Now what answer am I to make to the question: whether this knowing-one's-way-around-in-this-room is a state of mind?

Page Break 60

Page 60

296. The question "What's a thermometer for?" I am in a position to answer *at once*, without any difficulty, with a long string of sentences. And equally I can meet the request: "Explain the application of the word 'book'."

Page 60

297. Knowing one's way about can be called an experience, and again, also, not.

Page 60

298. The employment of certain words for the sake of the rhythm of a sentence. This might be *far* more important to us that it actually is.

Page 60

299. "What kind of experience is...?" One won't ask "What's it like when YOU have it?"--for this might be answered by one person this way, by another that. One won't ask them for a description of the experience, but will rather look to see how and on what occasions people mention the experience, speak of it, *without* trying to describe it.

Page 60

300. I say the word "tree", then I say a nonsense-word. They feel different. To what extent?--Two objects are shewn me: One is a book, the other a thing unknown to me with a peculiar shape. I say: they not merely look different, but I also have a different feeling on looking at them. The first thing I 'understand', the other I don't understand. "Yes, but it is not only the difference between familiarity and strangeness." Well, is there not also a difference between kinds of familiarity and strangeness? A stranger walks into my room, but it is a human being, so much I see at once. Some swathed thing walks into my room. I don't know if it is man or beast. I see an unfamiliar object on my table, an ordinary pebble, but I never saw it before on my table. I see a stone on the path; I am not astonished, although I do not remember having seen just that stone before. I see on my table a queer-shaped object whose function is unknown to me and am *not* surprised: it was always there, I never knew *what* it was and was never interested to know, it is thoroughly familiar to me.

Page 60

301. "Didn't you understand the word 'tree' when you heard it?--In that case something did go on in you!"--And what?--I *understood* it.--Only the question is: Am I to say about understanding, that it went on in me? Something goes against this; and that can only mean that by means of this expression we put understanding together with other

Page Break 61

phenomena and elide a difference which we want to emphasize. But what difference?--Well, in what cases do we *not* resist saying: something went on in us as we heard the word?

Page 61

302. What would we need to say to someone who told us that in *his* case understanding was an inner process?--What retort should we make to him, if he said that with him being able to play chess was an inner process?--Some such thing as, that we aren't interested in anything that goes on in him when we want to know

whether he can play chess. And if he now replies that we *are* interested in what goes on in him after all, namely: in whether he can play chess--then we could contradict him by reminding him of the *criteria* which would prove his capacity to us. [Cf. P.I. p. 181b.]

Page 61

303. In order to know your way about an environment, you do not merely need to be acquainted with the right path from one district to another; you need also to know where you'd get to if you took this wrong turning. This shews how similar our considerations are to travelling in a landscape with a view to constructing a map. And it is not impossible that such a map will sometime get constructed for the regions that we are moving in.

Page 61

304. Suppose you do have a peculiar experience when you understand, how can *you* know that it is the one we call "understanding"?--Well, how do you know, then, that the experience that you have is the one we call "pain"?--That is different--I know that, because my spontaneous behaviour in certain situations is what is called the expression of pain.

Page 61

305. When one learns to use the word "pain", that does not happen through guessing which of the inner processes connected with falling down etc. this word is used for.

For in that case this problem might arise as well: on account of *which* of my sensations do I cry out when I damage myself?

And here I imagine one's pointing inside and asking himself: "Is it *this* sensation, or *this* one?"

Page 61

306. "It doesn't matter whether I have attached the *right* name to the sensation--I just have attached *a* name to it!"--But now, how does one attach a name to something, e.g. to a sensation? Can one *within oneself* attach a name to a sensation? What happens here; and what is the result of this action? ((Cf. Remark on attaching a name-tag to

Page Break 62

something.†1)) if one shuts a door in one's mind, is it then shut? And what are the consequences? That, in one's mind, now no one can get in?

Page 62

307. "How do *you* know, then, that the experience which you have is the one that we call 'pain'?" The experience that I have? Which experience? How do I specify it: for myself, and for another?

Page 62

308. Suppose we could learn what it is that people call a sensation, say a 'pain', and then someone taught us to *express* this sensation. What kind of connexion with the sensation would this activity need to have, for us to be able to call it the 'expression' of that sensation?

Page 62

309. Suppose someone knew, guessed, that a child had sensations but no expression of any kind for them. And now he wanted to teach the child to express the sensations. How must he connect an action with a sensation, so that it becomes the expression of the sensation?

Page 62

310. Can he teach the child: "Look, this is how one expresses something--*this*, for example, is an expression of *this*--and now you express your pain!"

Page 62

311. "Understand" just is not used like a word for a sensation.

Page 62

312. The confusing picture is this: that we observe a substance--its changes, states, motions; like someone observing the changes and motions in a blast furnace. Whereas we observe and compare the attitudes and behaviour of human beings.

Page 62

313. Primitive pain-behaviour is a sensation-behaviour; it gets replaced by a linguistic expression. "The word 'pain' is the name of a sensation" is equivalent to "I've got a pain' is an expression of sensation".

Page 62

314. Forms of behaviour may be incommensurable. And the word "behaviour", as I am using it, is altogether misleading, for it includes in its meaning the external circumstances--of the behaviour in a narrower sense.

Page Break 63

Page 63

Can I then speak of one behaviour of anger, for example, and of another of hope? (It is easy to imagine an orang-utan angry--but hopeful? And why is it like this?) [Cf. P.I. p. 174a.]

Page 63

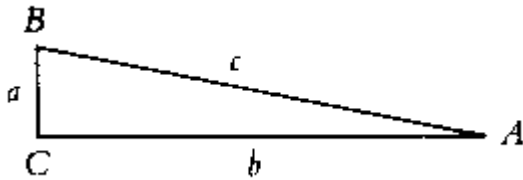

315.

Page 63

If someone tells me: "Now I am seeing *this* point as the apex of the triangle" I understand him. But what do I do with this understanding? Well, I can, e.g., say to him "Does the triangle strike you now as if it had fallen over, as if it normally stood on the base line *a*? Or does it now appear to you as a mountain with *B* as its peak? Or as a wedge? Or as an 'inclined plane'? Or as a cone?"

You may now ask "What does it *consist* in: to see the figure like *this*?"--and you may, so to speak, form hypotheses about what goes on here. E.g., eye movements, or images, with which one supplements the seen--one imagines a body, say, that slides down the inclined plane--etc. All this *may* happen but need not; and when someone tells me he sees the triangle as a wedge etc. he is *not* telling me how his eyes have been moving etc.--No, the question is not *what happens here*, it is: how one may use that statement. E.g. what my understanding of the information does for me.

One application would be this: One may tell someone: "Look at the triangle as a wedge, and then you won't wonder at... any more." And at this perhaps he says "Yes, like that it strikes me as more natural".--So I have removed some disquiet with my explanation; or helped him to do an exercise more quickly.

Page 63

316. Seeing the resemblance of one face to another, the analogy of one mathematical form with another, a human form in the lines of a puzzle picture, a three-dimensional shape in a schematic drawing, hearing or pronouncing "pas" in "ne... pas" with the meaning "step"--all these phenomena are somehow similar, and yet again very different. (A visual perception, an auditory perception, an olfactory perception, a perception of movement.)

Page Break 64

Page 64

317. In all these cases one may be said to experience a *comparison*. For the expression of the experience is that we are inclined towards a comparison. Inclined to make a paraphrase.

It is an experience whose expression is a comparison. But why an 'experience'? Well, our expression is an experience-expression. Because we say "I see it as...", "I hear it as..."? No; though this form of expression hangs together with that. But it is *justified*, because the language-game makes the expression into expression of an experience.

Page 64

318. An experience that is manifested in a comparison.--In order, e.g., to hear "Je ne sais pas" in that conscious way one has to be acquainted with other expressions like "not a thing".†1

The expression of the experience by means of the comparison precisely is *the* expression of it, the immediate expression. It is the very phenomenon that we observe and that interests us.

Page 64

319. If now someone couldn't hear "pas" like this, couldn't experience it; if he didn't understand what we mean by speaking of 'hearing as'--would he also fail to understand us when we explain that even in the negation "pas" did once mean the same as "step", and if we said it was analogous to the word "bit", "thing", "bißchen" etc? But what is the insight into, by which someone perceives that the use of the word... is *analogous* to that of the word...?

Page 64

320. Well, what do I shew someone such an analogy for? What do I expect from doing so? What effect has it?--It surely has the appearance of an explanation. It is *one* kind of explanation. For one does say: "Yes, now I understand the use of this word." But one also says: "I know what you mean, but I can't *hear* it as that."

Page 64

321. "Just as we still... at the present day, so these people...."

We are able to look at *this* custom in the light of *that* one. This may serve, e.g. as a heuristic principle.

Page 64

322. While any *word*--*one* would like to say--may have a different character in different contexts, all the same there is one character--a face--that it always has. It looks at us.--For one might actually think that each word was a little

face; the written sign might be a face. And one might also imagine that the whole proposition was a kind of group-picture, so that the gaze of the faces all together produced a relationship among them and so the whole made a *significant group*. But what constitutes the experience of a group's being significant?

Page Break 65

And would it be necessary, if one is to use the proposition, that one feel it as significant in this way? [Cf. P.I. p. 181d.]

Page 65

323. For is it even certain that anyone who understands our language would be inclined to say that each word has a *face*? And--the most important thing what general tendency in us is this inclination part of?

Page 65

324. First of all it is clear that the tendency to regard the word as something intimate, full of soul, is not always there, or not always in the same measure. But the opposite of being full of soul is being mechanical. If you want to act like a robot--how does your behaviour deviate from our ordinary behaviour? By the fact that our ordinary movements cannot even approximately be described by means of geometrical concepts.

Page 65

325. Would one also get an impression of a group-picture from sentences written in telegraphic style?

Page 65

326. A convict has a number for a name. No one would say of it what Goethe says about people's names.

Page 65

327. One has the idea that the sense of a sentence is composed of the meanings of its individual words. (The group-picture.) How is, e.g. the sense "I still haven't seen him yet", composed of the meanings of the words?

Page 65

328. Even the word "state" has a face, for at any rate "the State" has a *different* face. It feels different; and so "state" would also have to feel somehow or other!--But *must* "state" feel different from "State"? Suppose someone were to assure me that to him *these* two words felt just the same? He says, e.g. I feel the connective and the verb "still" differently all right, but not "State" and "state". Would we have the right to disbelieve him?

What looked like a quite matter-of-course expression, which is tied up with the understanding of the words, appears here in the light of a purely personal expression of feeling. No different from someone's saying that for him the vowels a and e are the same colour. Can I now say to this man: "You aren't playing our game"?

Page 65

329. If you have fine perceptions, will you assume that you feel the two words "still" differently in all contexts? No. One expects that only when one pronounces them experimentally.

Page Break 66

Page 66

330. Imagine human beings who calculate with 'extremely complicated' numerals. These, however, get represented as figures that arise when one writes our numerals one on top of the other. They write π , for example, up to the fifth



decimal place like this:

Anyone who watched them would find it difficult to guess what they were up to. And they might themselves not be able to explain. For this numerical sign may alter its appearance (for us) up to the point of unrecognizability when it is written in a somewhat different script. And what the people were doing would appear to us as purely intuitive. [Cf. Z. 699.]

Page 66

331. Thus I am saying: one makes a false estimate of the psychological interest of the if-feeling if one looks at it as the matter-of-course correlate of the meaning of the word; it must rather be seen in a different context, in the context of the special circumstances under which it occurs. [Cf. P.I. p. 182c.]

Page 66

332. Say "It is hard to still one's fears" and pronounce the fifth word with the feeling of a connective! In the course of ordinary conversation, practise pronouncing a word which has two meanings with the inappropriate feeling. (If it is not connected with a wrong tone of voice, it doesn't impede communication.)

Page 66

333. Now say to yourself: the connective "still" is really the same as the verb "still" just as "away" = "a-way" and "despite" (noun) = "despite" (preposition) and pronounce the sentence "Bad as things are, still they might be worse",

with "still" in the meaning of the verb!

Page 66

334. Are you even sure that there is a *single* if-feeling? and not perhaps several? Have you tried to pronounce the word in very different contexts? (When, e.g., it bears the main emphasis of the sentence, and when the word next to it does.) [Cf. P.I. p. 181e.]

Page 66

335. Does anyone ever have the if-feeling when he is not pronouncing the word "if"? It would surely be at any rate remarkable, if only *this* cause was supposed to call up the sensation. Did James ever ask himself whether, and where, one has it otherwise?--And that's how it is with the 'atmosphere' of a word:--why does one regard it as so

Page Break 67

much a matter of course that only *this* word has *this* atmosphere? [Cf. P.I. p. 182d.]

Page 67

336. Goethe's signature intimates something Goethian to me. To that extent it is like a face, for I might say the same of his face.

It is like a *mirroring*. Does this phenomenon belong with this other one: "I have been in this situation before"?

Or do I *identify* the signature with the person in that, e.g. I love to look at the signature of a beloved human being, or I frame the signature of someone I admire and put it on my desk? (Magic that is done with pictures, hair etc.)

Page 67

337. The atmosphere is *inseparable* from the thing.--So it is not an atmosphere.

What are inwardly associated *got* associated, they seem to fit one another. But how do they seem to do that? What is the expression of their seeming to fit? Is it like this: we can't imagine that the man who was called this, looked like this, had this signature, produced, not *these* works, but maybe quite different ones (those of another great man)?

Page 67

We can't imagine that? Do we try? [Cf. P.I. p. 183c.]

Page 67

338. It might be like *this*: Imagine a painter wanting to sketch a picture "Beethoven writing the ninth symphony". I could easily imagine what one might see in such a picture. But suppose someone wanted to depict how Goethe would have looked writing the ninth symphony? Here I should not know how to imagine anything that would not be extremely incongruous and ridiculous. [Cf. P.I. p. 183d.]

Page 67

339. Look at a long familiar piece of furniture in its old place in your room. You would like to say: "It is part of an organism." Or "Take it outside, and it's no longer at all the same as it was", and similar things. And naturally one isn't thinking of any *causal* dependence of one part on the rest. Rather it's like *this*: I could give this thing a name and say that it is shifted from its place, has a stain, is dusty; but if I tried taking it *quite* out of its present context, I should say that it had ceased to exist and another had got into its place.

One might even feel like this: "Everything is part and parcel of everything else" (internal and external relations). Displace a piece and it is no longer what it was. Only in this surrounding is this table this table. Everything is part of everything. Here we have the inseparable atmosphere. And what is anyone saying, who says this? What sort of method of representation is he proposing? Isn't it that

Page Break 68

of the painted picture? If, for example, the table has moved, you paint a new picture of the table *with* its surrounding.

Page 68

340. "A quite particular expression"--it is part of this that if one makes the slightest alteration in the face, the expression changes at once.

Page 68

341. His name seems to fit his works.--*How* does it *seem* to fit? Well, I express myself in some such way.--But is that *all*?--It is as if the name together with these works, formed a solid whole. If we see the name, the works come to mind, and if we think of the works, so does the name. We utter the name with reverence.

The name turns into a gesture; into an architectonic form.

Page 68

342. If anyone didn't understand this, we should want to designate him as, say, 'prosaic'. And is that what the

'meaning-blind' would be?

Page 68

343. Any other arrangement would strike us as incorrect. Through custom these forms become a paradigm; they acquire so to speak the force of law. ("The power of custom"?)

Page 68

344. Anyone who cannot understand and learn to use the words "to *see* the sign as an arrow"--that's whom I call "meaning-blind".

It will make no sense to tell him "You must try to *see* it as an arrow" and one won't be able to help him in *that way*.

Page 68

345. But what about such an expression as *this*: "As you said it, in my heart I understood it"? At the same time one points to one's heart. And doesn't one *mean* this gesture?! Of course one means it. Or is one conscious of only using a picture? Certainly not! [Cf. P.I. p. 178h.]

Page 68

346. When the child learns to talk, when does it develop the "feeling of meaning"? Are people interested in this, when they teach it to talk and observe its progress in talking?

Page 68

347. Again, observing an animal, e.g. an ape that investigates an object and tears it to pieces, one may say: "You see that something is going on in him." How remarkable that is! But not more remarkable than that we say: love, conviction, are in our hearts!

Page Break 69

Page 69

348. When and how does a human being begin to manifest feelings of meaning? In what games will it be revealed?

Page 69

349. Isn't the inclination to think of a meaning-body like the inclination to think of a seat of thought?--*Must* everyone be inclined to say he thinks in his head? This expression is taught him as a child. ("Doing sums in one's head.") But at any rate the *inclination* develops from this (or the expression developed from it). In any case--the inclination is then present. And so is the inclination to speak of a meaning-body (or the like) *how ever* it arose.

Page 69

350. Do we also speak of a '*feeling*' of thinking in the head? Wouldn't this be like the 'feeling of meaning'?

Again: Suppose someone who wouldn't have this feeling. Is he unable to think?

Indeed, someone who does philosophy or psychology will perhaps say "*I feel that I think in my head*". But what that means he won't be able to say. For he will not be able to say *what* kind of feeling that is; but merely to use the expression that he '*feels*'; as if he were saying "*I feel this stitch here*". Thus he is unaware that it remains to be investigated what his expression "I feel" means here, that is to say: what consequences we are permitted to draw from this utterance. Whether we may draw the same ones as we would from the utterance "I feel a stitch here".

Page 69

351. For one might also say "*I feel the rise in prices in my head*". And is that *nonsense*? But under what heading in psychology should we put this feeling? It doesn't belong under 'sensation'--unless someone were to say "When I feel this pain in my head, there is always a rise in prices".

Page 69

352. Might not someone say: "I have a feeling of a place when I think. I may, for example, think the thought... now in my head, now in my heart."--And would that shew that a thought has a place? I mean: would it describe the experience of thinking more closely? Wouldn't it rather describe a *new* experience?

"I should like to say: 'I thought in my head'."

Page 69

353. One can obey the order "Think of nothing at all", "make your mind a blank".

Page 69

354. Just as we have learnt the phrase "in the head" in connexion with thinking, so too we have learnt "the word has this ('one')

Page Break 70

meaning" and all the phrases that are akin to it. And also the form of expression: "these two words only sound the same, but otherwise they have nothing to do with each other" and many similar ones. And the experience of meaning really follows these turns of speech exactly. (Though they might have a completely different form--the French "vouloir dire" for example.)

355. So is the experience of meaning a mere fancy? Well, even if it is a fancy, that does not make the experience of this fancy any *less* interesting.

356. Incidentally, it is striking that the word "association" plays so small a part in my considerations. I believe that this word is used in an extremely vague, blurred kind of way, and for quite dissimilar phenomena.

357. *Much* can be said about a fine aesthetic difference--this is very important. That is to say, the first utterance is of course merely "*This* word fits, *this* one does not" or the like; but then there may be discussion of all the widely ramified connexions made by each of these words. That is to say, it is *not* all over once that first judgment has been made; rather what it depends on is the *field* of each word. [Cf. P.I. p. 219b.]

358. Why should the experience of meaning be important? He says the word, says he said it now in this meaning; then, in that one. I say the same. This obviously has nothing to do with the ordinary and important use of the expression "*That's* what I meant by this word". So what is the remarkable thing? That we say something of that sort? Naturally that is of interest. But the interest here does not depend on the concept of the 'meaning' of a word, but on the range of similar psychological phenomena which in general have nothing to do with word-meaning.

359. Someone says, perhaps in a language lesson, "Let us talk about the word 'still'". I ask: "Do you mean the noun, the adjective, or the verb?"--He: "I mean the noun." Need he, or I, have had an experience of meaning here? No. Though it is likely that images have come into our minds during this exchange. They will, e.g., play the same part as scribbling while one speaks. If someone were accustomed to scribble on paper during a conversation, he would perhaps one time draw a still, another time a lake, another time the word "Still!"

And if the talk were of a still and he were to draw a lake, this might distract him from the conversation; but if he draws pipes, then he'd be staying with the thing.

360. To what extent can doodling be compared to the play of images?--Imagine human beings who, from childhood up, make drawings on all occasions where we should say they are imagining something. If one puts a pencil in their hand then they draw at high speed.

But doesn't the ordinary human being do something quite similar? He doesn't draw indeed, but he 'describes his image', i.e., instead of drawing, he *speaks*. Or again, he uses gestures in order to represent, e.g. someone whom he is imagining. Must I assume that he *reads off* this description, these gestures, from something? What is there to be said for this?--Well, perhaps he *says* "I see him before me!" and then he represents him. But if, instead of this expression, I had taught him to say "Now I know what he looks like" or "Now I can say what he looks like" or "Now I'll tell you what he looks like"--then the dangerous picture would be eliminated. (Tennis without a ball.)

361. In order to climb into the depths one does not need to travel very far; no, for that you do not need to abandon your immediate and accustomed environment.

362. How do I find the 'right' word? How do I choose among words? It is indeed as if I compared words according to fine discriminations of taste. *This* is too... *this* too...--that's the right one.

But I don't need always to judge, to explain, why this or that isn't the right word. It simply *isn't right* yet. I go on searching, am not satisfied. *This* is just what it looks like to search, and *this* is what it looks like, to find. [Cf. P.I. p. 218h.]

363. "*I am developing what there is in it.*" How do I know that this was *in* it?--That's not how it is. Nor can one ask "How do I know that this is what I actually dreamt?" It is there in it because I *say* it is. Or better: because I am inclined to say... And what sort of queer experience is that: being inclined to say...? Not an experience at all.

364. If, however, I had died before I could develop all this--in that case would it *not* have been contained within my experience?--The

answer "No" to this question is wrong; the answer "Yes" must be wrong too.

"No" would mean: If someone does not tell a dream, it is false to say he had it. It would be incorrect to say: "I don't know whether he had a dream; he said nothing about it."

"Yes" would mean: He may well have had a dream even when he doesn't report it. But that isn't supposed to be a *psychological* statement! A logical one, then.

Page 72

365. May someone not dream and yet not tell anyone? Certainly: for he may dream *and* tell someone.

Page 72

366. We read in a story that someone had a dream and did not tell it to anyone. We don't ask how the author could learn it.--Don't we *understand* it, when Strachey makes surmises about what Queen Victoria may have seen in her mind's eye just before her death? Of course--but didn't people also *understand* the question how many souls there was room for on the point of a needle? That is to say: the question whether one understands this does not help us here; we must ask *what* we can do with such a sentence.--*That* we use the sentence is clear; *how* we use it is the question.

Page 72

367. *That* we use the sentence doesn't yet tell us anything, because we know the enormous variety of use. Thus we see the problem in *How*.

Page 72

368. Once more: people narrate something to us after waking up; we thereupon teach them the expression "I dreamt..." followed by the narrative. I then sometimes ask them: "Did you dream anything last night?" and sometimes get an affirmative, sometimes a negative answer, sometimes a dream narrative, sometimes none. That is the language-game. (I have assumed now that I myself do not dream. But neither do I have the feeling of an invisible presence and other people do have it, and I can ask them about their experiences.)

Now must I make an assumption in this case about whether these people's memory has deceived them or not; whether they *actually* saw these pictures before them during their sleep or whether it's merely that that's how it seems to them after waking up? And what is the sense of this question?--And what interest has it?! Do we ever ask ourselves that, when someone tells us a dream and if not,--is it because we are sure that his memory won't have deceived him? (And

Page Break 73

suppose he was a man with a quite specially bad memory!) [CF. P.I. p. 184a.]

Page 73

369. And does that mean that it is *nonsense* ever to raise the question whether the *dream* really when on in the night, or whether the dream is a memory-phenomenon of the awakened? That depends on *what* we intend, i.e. *what* use we are making of this question. For if we form the picture of dreaming, that a picture comes before the mind of the sleeper (as it would be represented in a painting) then naturally it makes sense to ask this question. One is asking: Is it like *this*, or like *this*--and to each "this" there corresponds a different picture. [Cf. P.I. p. 184b.]

Page 73

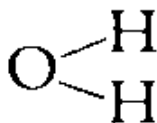

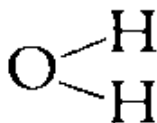
370. (Suppose someone were to ask: Is the structure of water  or H-O-H? Does it make sense?--If you give it a sense, it does make sense.)

Page 73

371. Back to the language-game of telling dreams: Someone says to me one day: "What I dreamt last night I will tell no one." Now does that make sense? Why not? Am I supposed to say, after what I have said about the origin of the language-game, that it makes no sense--as the original phenomenon just was the dream *narrative*? Absolutely not!

Page 73

372. To us, a railway station, with all its equipment, telegraph poles and telegraph wires, means an extensively ramified system of traffic. But on Mars there is to be found this structure with all its whys and wherefores, even with a bit of railway track, and there it means nothing of the kind.

Page 73

373. "The mind seems able to give the word meaning"--isn't this as if I were to say: "The carbon atoms in benzene seem to lie at the corners of a hexagon."? But that is not something that seems to be so: it is a *picture*. [Cf. P.I. p. 184c.]

Page 73

374. Of course I don't want to give a *definition* of the word "dream"; but still I want to do something like it: to describe the use of the word. My question then runs roughly like this: If I were to come to a strange tribe with a

language I didn't know, and the people had an expression corresponding to our "I dream", "He dreams" etc.--how should I find out that this was so; *how* should I know which

Page Break 74

expressions of their language I am to translate into these expressions of ours?

For finding *this* out is like finding out which of their words I am to translate into our word "table".

Here of course I don't ask "What do they call *THIS*?" while I point at something. Although I might ask even that, and might point to a symbolic representation of a dream or a dreamer.

Page 74

375. There is also this to say: the child does not absolutely have to learn the use of the word "to dream" by first merely reporting an occurrence on waking up, and our then teaching it the words "I dreamt". For it is also possible that the child hears the grown-up say he has dreamt and now says the same thing of itself and tells a dream. I am *not* saying: the child *guesses* what the grown-up means. Suffice it that one day it uses the word, and uses it under the circumstances under which we use it.

Page 74

376. So the proper question is not: "How does he learn the use of the word?" but rather "How does it come out that he does use it as we do?"

Page 74

377. "Black is the beauty of the brightest day"†1--Can one say "Well, it *seems* as if it were black?" Have we then an hallucination of something black?--So what makes these words *apt*?--"We understand them." We say, e.g. "Yes, I know exactly what that's like!" and now we can describe our feelings and our behaviour.

Page 74

378. "When you are talking about dreaming, about thinking, about sensation,--don't all these things seem to lose the mysteriousness which seems to be their essential characteristic?" Why should dreaming be more mysterious than the table? Why should they not both be equally mysterious?

Page 74

379. "The phenomenon of seeing  as an arrow or otherwise is surely a true visual phenomenon; even though it is not so tangible as that of form and colour." How should it not be a visual phenomenon?!--Does anyone that speaks of it ever doubt that it is (except when he is doing philosophy or psychology)? Don't we ask a

Page Break 75

man about it and tell him of it, like any other visual phenomenon? I mean: Do we talk of it more hesitantly, with the suspicion that what we say may have no clear sense? Certainly not. But there are differences in it, all the same. The ones that we indicate when we say "more intangible."

Only it is like this: If I put two substances in front of someone, I may say: Feel this one here. Don't you find that it feels softer?" And if he answers yes, I say, e.g. "Yes, I feel that too. So there is a difference between them." (I.e.: I have not merely fancied it.)--But it is *otherwise* with psychological phenomena. When I say "This is more intangible than that"--as, that is, a tenseless proposition--this does not rest upon a consensus of judgements, *not* upon our all feeling that too (when we '*contemplate*' the experience).

Page 75

380. Don't put the phenomenon in the wrong drawer. *There* it looks ghostly, intangible, uncanny. Looking at it rightly, we no more think of its intangibility than we do of time's intangibility when we hear: "It's time for dinner." (Disquiet from an ill-fitting classification.)

Page 75

381. "This coffee has *no taste at all*." "This face has *no expression at all*."--The opposite of this is "It has a quite particular expression" (though I could not say what). A *strong* expression I could easily connect with a story for example. Or with looking for a story. When we speak of the enigmatic smile of the Mona Lisa, that may well mean that we ask ourselves: In what situation, in what story, might one smile like that? And so it would be conceivable for someone to find a solution; he tells a story and we say to ourselves "Yes, *that* is the expression which *this* character would have assumed here".

Page 75

382. Remembering a particular kinaesthetic sensation--remembering the visual image of a movement.--Make the same movement with the right and left thumb, and judge whether the kinaesthetic sensations are the same.--Have you a memory-image of the K-sensation in walking?--If you are tired, or suffering pain, muscular pain or a burning skin--are the sensations in moving a limb the same as in a different condition? But are you then sometimes in doubt

whether you now really have raised your leg, because the feeling is so totally different? Do you actually feel the movement in the joint?

Page Break 76

Page 76

383. You sometimes hear someone saying "I am imagining his bearing quite vividly"; or "his voice". But do you ever hear "I am imagining the K.-sensation in connexion with this movement of the hand"?! And *why* not?

Does one imagine it and merely not say so?

Page 76

384. What are we to answer if someone counters us: "If you guide someone's hand in a movement, by doing so you *are* shewing him a particular K.-sensation, which he then reproduces if he now repeats the movement when ordered to"? And can one say that obviously he may be guided in this way by the visual image of the movement--but not by a K.-image?

Page 76

385. How important is it that there is such a thing as a pictorial representation of the visual movement and nothing corresponding to it for the 'kinaesthetic movement'?

Make a movement that looks like *this*--"Make a movement that produces *this* noise". "Make a movement that produces *this* K.-sensation." Copying the K.-sensation correctly would in this case mean repeating the movement correctly according to the *appearance to the eye*.

Page 76

386. Imagine the movement's being *very* painful, so that the pain drowns out any other slight sensation. [Cf. P.I. p. 186d.]

Page 76

387. Make a movement with your fingers (such as you make in piano playing, say); repeat it, but with a lighter touch. Do you remember which of the two feelings you had yesterday in connexion with the first movement?

We say perhaps: "No, yesterday this movement looked rather different"--but do we also say "The movement is not quite the same--I did not have exactly this K.-sensation"?

Page 76

388. For of course we have feelings of movement and we *can* also reproduce them. Especially when we repeat a movement under the same circumstances after only a brief pause. One also localizes the sensations, but hardly ever in the joints, mostly in the skin. (Blow your cheeks out. Where do you *do* it, and where do you feel it?)

Page 76

389. The growth of analysis might be compared with the growth of a seed. And in this case to say "It was all already contained in

Page Break 77

the sensation" or "it grew out of it as from a seed" come to the same thing. Now how much is there (true) in this, that one sometimes reproduces an arm movement (say) according to a visual picture, but not according to a kinaesthetic picture?

Page 77

390. Does one actually sometimes go by a visual image in bending one's arm? I can only say: If I did not *see* that my arm has moved after being convinced I had moved it with my face turned away, I should become confused and should presumably trust my *eyes*. Seeing can at any rate tell me whether I have carried out my intended movement exactly, e.g. have reached the position that I wanted to reach; the *feeling* wasn't able to do that. I feel that I am moving all right, and I can also judge roughly *how* by the feeling--but I simply *know* what movement I have made, although you couldn't speak of any *sense-datum* of the movement, of any immediate inner picture of the movement. And when I say "I simply *know*..." "knowing" here means something like "being able to say" and is not in turn, say, some kind of inner picture.

Page 77

391. "In order to be able to say the feeling tells me where my arm now is, or how far I am moving it, one would need to have correlated feelings and movements. It should be possible to say: 'When I have the feeling... then in my experience my arm is over *there*'. Or: you would need to have a criterion of identity of the feelings *besides* that of the movement you've made." But even if this condition makes sense at all, is it fulfilled for *seeing*? Well, one can represent a visual picture by drawing. But as for giving someone, or oneself, the feeling that is characteristic of the arm's being bent at an angle of 30°, I mean without bending the arm--that one can't do.

Bend your arm a little. What do you feel?--A tension or suchlike here and there, and principally the rubbing of my sleeve.--Do it again. Was the feeling the same? *Roughly*. Roughly in the same places. Does *this* feeling always

accompany this movement, can you say so? No. And yet I find there is still something about this argument that doesn't fit.

Page 77

392. Imagine that certain movements produced notes and now it was said that we recognize how far the arm has moved from the note that strikes. That would surely be possible. (Playing a scale on the piano.) But what sort of presuppositions must be satisfied for it to be so? It would not be enough, e.g. that notes accompany the movements; nor that they are often like for like movements. Nor would it suffice to

Page Break 78

say: the note just *must* have a single identical quality for identical movements, as it is the only sense datum in which we can recognize the amplitude of the movement.

Page 78

393. But isn't there such a thing as a kind of private ostensive definition for feelings of movement and the like? E.g. I crook a finger and note the sensation. Now someone says to me: "I am going to produce certain sensations in your finger in such and such a way, without its moving; you tell me when it is *that* one that you have now in crooking your finger." Mightn't I now, for my own private use, call this sensation "S", use my memory as criterion of identity and then say "Yes, that's S again" etc.

Page 78

394. It would then also be conceivable that I should recognize the sensation and that it should occur *without* being accompanied by the conviction of the movement's having taken place--without the sense of movement.

Page 78

395. I can certainly, e.g., raise my knee several times in succession and say I have had the same sensation every time: Not as if I *always* had this sensation when I raise my knee, nor as if I can recognize the movement in the sensation, but merely: In this series of knee-movements I three times had the same sensation, produced by the movement.

Being the same here of course means the same thing as seeming the same.

Page 78

396. "I had the same sensation three times": that describes a process in my private world. But how does someone else know what I mean? What I call "same" in such a case? He relies upon it that I am using the word here in the same way as usual? But what in this case is the use that is *analogous* to the usual one? No, this difficulty is not a piece of over-refinement; he *really* does not know, cannot know, which objects are the same in this case.

Page 78

397. The example of the motor roller with the motor in the cylinder is actually far better and deeper than I have explained. For when someone shewed me the construction I saw at once that it could not function, since one could roll the cylinder from outside even when the 'motor' was not running; but *this* I did not see, that it was a rigid construction and not a machine at all. And here there is a close

Page Break 79

analogy with the private ostensive definition. For here too there is, so to speak, a direct and an indirect way of gaining insight into the impossibility. [See Z 248.]

Page 79

398. I named this sensation of movement "S". Now, for others it is the sensation I had when I made this movement. But for me? Does "S" now mean something else?--Well, for me it means *this* sensation.--But which is this? for I pointed to my sensation a minute ago, how can I now point to *it* again?

Page 79

399. But suppose the case where someone made a series of arm-movements and said: "The sensation that I now have in my leg, I call 'S₁,'" and so on. Later, on various occasions, he says "Now I have S₃". And so on. Such utterances might be important, if we observe certain physiological correlates, for example, and in this way are able to draw conclusions from his utterances.

Page 79

400. If it is true that we do not estimate the kind and magnitude of the movement of a limb by the *feeling* -- how would a human being differ from us, with whom that *was* the case? Well, *this* could quite easily be imagined: that someone felt pain-sensations varying in strength or kind with difference of movements. Thus he would say, e.g. "I feel this pricking when I bend my arm through an angle of about 90°"

Page 79

401. Imagine someone who by means of a dowsing rod, and going by the tug which it gives, can determine the depth of a water course. He learned this in the following way: He walked over water courses of various depths and *noted* the tug. (This might perhaps have been established with a spring balance.) He associated the tug with the

depth and now draws conclusions from the tug to the depth. This might happen in such a way that he states the tug--say in pounds--and makes a transition to the depth, perhaps using a table. However, it may also be the case that he knows no other measure of the tug than the depth of the water-course. After a certain amount of practice he can give the depth right. If one exerts a tug on the rod, say by using weights, he will say "That tugs like a water-course of such and such a depth".

Page 79

402. However, it might be that, while he was able to give the depth of a water course *right* by means of the tug of the rod, yet he was not

Page Break 80

able to give a correct estimate of the tug of the rod. I mean this as follows: It might be that water gives an equal tug at different depths in different circumstances; and this dowser now says, e.g.: "This water-course is deeper than the former one, it tugs more weakly"--and he is right: the water-course actually does lie deeper, but the tug measured by the spring balance was the same and he had not noted *it* correctly.--Am I to say in such a case: he judges the depth by the tug?

Page 80

403. He will perhaps say: "This tug is that of a water-course at depth..." while he as it were studies this tug--as one hefts a weight in one's hand. But perhaps he says: "I can't judge the tug--the water is at the depth...." In this (latter) case one will not say he judges the depth by the tug. (At least not 'consciously'.)

Page 80

404. Suppose now someone were to say he judged how far he has bent his arm by the strength of a sensation of pressure in the elbow. That surely means: When it reaches a certain strength he knows from that that the arm is bent to *this* degree. Or what else should it mean, that he judges the degree of the bending by the sensation of pressure?

Page 80

405. I want to say: How does anyone know that he judges something by *this* feeling--Does it suffice if he directs his attention to the feeling in making his estimate?

Page 80

406. If you say that for this someone must be able to say: "When the pressure is as strong as *this*, my arm is bent 90°"--then the 'this' must be capable of being specified. Otherwise that someone judges the bending by the strength of the sensations of pressure would at most mean that one *cannot* judge the bending when one has *no* sensation of pressure (or only an uncommonly weak one). (And so, e.g. when one is anaesthetized.)

Page 80

407. Thus there is a variety of cases. Someone may *say* he judges the bending by the sensation of pressure or pain, and may in doing this so to speak hearken to this sensation; but for the rest be quite unable to give the degree of the sensation in any form.--Or there may be two independent specifications: of the degree of the sensation and of the degree of bending.

Page 80

408. "When I feel the pressure as hard as *this*, then...." Doesn't that make sense? Someone might even say he had a whole scale of

Page Break 81

sensations of pressure. I can well imagine that. Only that would no more be an *actual* scale than the picture of a thermometer is a thermometer. Although in many respects it has a great similarity to a thermometer.

Page 81

409. I give the rules of a game. Quite in accordance with these rules, the other makes a move whose possibility I had not foreseen, and which spoils the game, at least as I meant it. I must now say: "I gave bad rules," I must change or perhaps add to my rules.

So did I in this way already have a picture of the game? In a certain sense: yes.

I might, for example, not have foreseen that a quadratic equation need not have real numbers as a solution.

The rule, then, leads me to something of which I say: "I had not expected this picture; I always pictured the solution like *this*...." [Cf. Z 293.]

Page 81

410. How would it be if one said: "Not every system of rules determines a calculus." One would give dividing through by 0 as an example. For let us imagine an arithmetic in which it was allowed and in consequence it could be proved that any number was equal to any other.

Page 81

411. When children play at trains--ought I to say that a child who is imitating a steam engine is seen by another as a

steam engine? He is *taken as* a steam engine in the game.

Suppose I had shown a grown-up the shape  and asked "What does that remind you of?" and he had replied "A steam engine"--does that mean that he *saw* it as a steam engine?

For I take it as the typical game of "seeing something as something", when someone says "Now I see it as this, now as that". When, that is, he is acquainted with different aspects, and that *independently* of his making any application of what he sees.

So I should like to say this: I do not see any application of the picture as a sign that the picture is *seen* this way or that.

Page 81

412. Would a child understand what it means to see the table 'as a table'? It learns: "This is a table, that's a bench" etc., and it completely masters a language game without any hint of there being an aspect involved in the business.

Page Break 82

Page 82

413. "Yes, it's just that the child doesn't analyse what it does." Once more: what is in question here is not an analysis of what happens. Only an analysis--and this word is very misleading--of our concepts. And our concepts are more complicated than those of the child; in so far, that is, as our words have a more complicated employment than its words do.

Page 82

414. "I surely see it like *this*, even if I don't express it." That would mean that what I see doesn't alter when I express it. If one were to ask "Has the body this weight only so long as it is being weighed?"--that would mean "Does the weight change when we put it on the weighing machine?" And naturally that is not at all the thing that we should like to ask.

Page 82

415. Only through the phenomenon of change of aspect does the aspect seem to be detached from the rest of the seeing. It is as if, after the experience of change of aspect, one could say "So there was an aspect there!"

Page 82

416. When one scrapes a coating off a thing one can say "So there was a coating there".--But if the *colour* of a body changes--can I say "So it had a colour!" as if this had only just struck me?

Can one say: I only became aware that the thing had a colour, when its colour changed?

Page 82

417. Do not think that it is something *queer* for you to see a picture on the wall three-dimensionally. It is--I should like to say--as ordinary as it seems. (And I might say this about a lot of things.)

Page 82

418. Imagine that the things that surround us--table, books, chairs etc.--underwent abrupt periodic colour changes; their shapes remain the same. Might one say here that this was how we first became conscious of colour and shape as special constituents of our visual experience?

Page 82

419. When I compare wild flowers and garden flowers, this may make me conscious of the difference of *character*; but that is not to say that I must already earlier on have perceived their character as well as the flowers themselves, or that I must after all have perceived them as having some character or other.

Page 82

420. Must I know that I see with two eyes? Certainly not. Do I perhaps have two visual impressions in ordinary seeing, so that I notice that my three-dimensional visual impression is compounded of

Page Break 83

two visual pictures? Certainly not.--So I can't separate threedimensionality from seeing.

Page 83

421. If I ask someone "Which direction would you say an 'F' looks in and which a 'J'?" and he answers that for him an F always looks to the right, a J to the left--of course that does not mean that whenever he looks at an F he always has a sensation of direction. This becomes clearer if one puts the question like *this*: "Where would you paint an eye and a nose onto an F?"--But if it were now said: "So it looks in this direction for you only as long as you are thinking this or saying it"--isn't that as if one were to ask "Would you paint the nose there on an F, only at the time that you are actually painting it?"

Page 83

422. Do I always see a face '*as a face*'? I have books here in front of me: Do I see them the whole time '*as books*'? I

mean: Do I see them the whole time as books, if I don't precisely see them as anything else? Or do I often, or ordinarily, see only colours and shapes, without any special aspect? (Obviously not!) We tell someone: "If *that* is the base then *that* is the apex and *that* the altitude." Or he has to answer the question: "What is the altitude of the triangle, when *this* is the base?" But we don't insist on his *seeing* the triangle in this or that way.--One may well sometimes say: "Imagine it turned round" (or the like) and one might also say "See it turned round", and this remark might help; in the way, that is, in which some drawn lines completing the picture might help if they suggested this aspect.

Page 83

423. Can I, e.g., say: I see the chair as *object*, as *unit*? In the same way as I say I see now the black cross on a white ground, and now the white cross on a black ground?

If someone asks me "What have you there in front of you?" I shall of course answer "A chair"; so I shall treat it as a unit. But can one now say I *see it as a unit*?

And can I see the cross-figure *without* seeing it *this way or that*?

Page 83

424. When I ask someone "What do you see in front of you" and he says "What I have in front of me looks *like this*" and now he draws the cross-figure--*must* he have seen it in some aspect or other? Has he not seen it, if he can only describe it by drawing?

Page 83

425. Can a child inform you that it sees three-dimensionally?

And imagine its saying to you "I see everything flat"--what would that tell you? It might see everything flat and know through intuition that it *isn't* flat, and behave correspondingly!

Page Break 84

Page 84

426. If the child takes this picture for such-and-such and now I conclude: "So it sees the picture in this way"--what sort of conclusion am I drawing? What does this conclusion say to me? It would perhaps be said that I was inferring the kind of sense-datum or visual picture the child had: as if the conclusion ran: "So the picture in its mind is like *this*"; and now one would have to give (say) a plastic representation of it.

Page 84

427. Then is it like *this*: "I have always read the sign ' Σ ' as a sigma; now someone tells me it could also be an M turned round, and now I can see it like that too: so I have always *seen it as* a sigma before"? That would mean that I have not merely seen the figure Σ and read it like *this*, but I have also *seen it as this*!

Page 84

428. "But how could I know that I should have reacted like this if you had asked me?"--How? There is no How. But there are indications that I am right in saying it.

Page 84

429. I want to describe what I see; for this purpose I prepare a transparency. But now I am further asked "Is *this* in front and *this* behind?" So, by means of words or a model, I describe what I see in front and what behind. And then I am further asked "And do you see *this* point as the apex of the triangle?" and now I must answer this as well.--But must I have an answer to it?--Assume, though it is not true, that the direction of one's glance determines the aspect. And in one case my gaze is continuously directed on to the same point in the picture, in another it moves in a regular fashion according to a simple law, in a third it wanders randomly back and forth over the object. If we now replaced a description of the aspect by that of the direction of glance, would it not be a description to say that the direction of glance was random, or indeterminate? And that might be just the ordinary case.--To the question "Did you see this point as the apex of the triangle?", then, the answer might be "I can't mention any particular aspect" or perhaps "At any rate I didn't see it like *this*".

Page 84

430. What, however, did the hypothesis of the importance of the direction of glance do for us?--It offered us a picture of definite multiplicity.

Page 84

431. But such a theory is really the construction of a psychological model of a psychological phenomenon. And hence of a physiological model.

Page Break 85

Page 85

The theory really says "It could be like this:...." And the usefulness of the theory is that it illustrates a concept.

It may illustrate it better and worse; more, and less, appropriately. The theory is thus so to speak a notation for this kind of psychological phenomenon.

Page 85

432. Thus if we 'leave explanation'--if we say that after all we don't mind about the *explanation*--what is left over is a grammatical stipulation. It concerns the use of the statement "I am now seeing a particular facial expression in the picture".

Page 85

433. Doesn't the theme point to something outside itself? Oh, yes! But that means:--The impression that it makes on me hangs together with things in its surroundings--e.g. with the existence of our language and its intonation; but that means: with the whole field of our language-games.

When I say, e.g.: It is as if a conclusion were being drawn here, or as if here something were being confirmed, or, as if this were the answer to what went before,--in this way my understanding presupposes familiarity with conclusions, confirmations, answers. [Cf. Z 175; *Culture and Value*, pp. 51-52.]

Page 85

434. A theme has a facial expression just as much as a face does. [*Vermischte Bemerkungen*, 2nd ed. p. 101; *Culture and Value*, p. 52.]

Page 85

435. "The repetition is *necessary*." To what extent is it necessary? Well, sing it, and you will see that it takes the repetition to give it its great strength.--Doesn't it seem to us as if there had to be a text for the theme existing in reality, and the theme would approximate to it, would correspond to it, only if this part was repeated? Or am I to utter the stupidity "It sounds finer with the repetition"? And surely there just is no paradigm there outside the theme. And yet after all there *is* a paradigm outside the theme: namely the rhythm of our language, of our thinking and feeling. And the theme is also in its turn a *new* bit of our language, it is incorporated in it; we learn a new *gesture*. [Cf. C. & V., p. 52.]

Page 85

436. The theme and the language are in reciprocal action. [Cf. C. & V., p. 52.]

Page 85

437. "A whole world of pain lies in these words." How *can* it lie in them?--It hangs together with them. The words are like an acorn from which an *oak-tree* can grow.

But where is the law laid down, according to which the tree grows

Page Break 86

out of the acorn? Well, experience has incorporated the picture into our thought. [Cf. C. & V., p. 52.]

Page 86

438. "Where do you feel grief?"--In my mind.--And if I had to give a place here, I should point in the region of the stomach. For love, to the breast and for a flash of thought, to the head.

Page 86

439. "Where do feel your grief?" In my mind.--Only what does that mean?--What kind of consequences do we infer from this place-assignment? One is, that we do *not* speak of a physical place of grief. But *all the same* we do point to our body, as if the grief were in it. Is that because we feel a physical discomfort? I do not know the cause. But why should I assume it is a bodily discomfort? [Cf. Z 497.]

Page 86

440. Think of the following question: Can one imagine a pain, with, say, the quality of rheumatic pain, but *without* locality? Can one *imagine* it?

When you begin to think this over, you see how much you would like to change the knowledge of the place of pain into a characteristic of what is *felt*, into a characteristic of the sense-datum, of the private object that is there before my mind. [Cf. Z 498.]

Page 86

441. I say that to the grief-stricken the whole world looks grey. But what was before my mind would in that case not be grief, but a grey world: as it were the cause of grief.

Page 86

442. Seeing something as difference of colour--and on the other hand as shadow, the colour being the same. I ask "Have you perceived the colour of the table in front of you, which you've been looking at the whole time?" He says "Yes". But he would have described the colour of the table as "brown" and has not noticed that the green curtains are reflected in its shining surface. Now has he not had the green sense-impression?

"Is the wall in front of you uniformly yellow?" "Yes." But it is partly in shadow and looks almost grey.

Now what did he see, when he looked at the wall? Am I to say, a uniformly yellow surface, which admittedly

is irregularly shadowed? Or: yellow and grey patches?

Page 86

443. It is a remarkable fact that we are hardly ever conscious of the unclarity of the periphery of the visual field. If people, e.g., talk about the visual field, they mostly do not think of that; and when one speaks

Page Break 87

of a representation of the visual impression by means of a picture, one sees no difficulty in this. This is very important.

Page 87

444. "What I perceive is *THIS*--" and now follows a form of *DESCRIPTION*. One might also explain this in this way: Let us imagine a direct transfer of the experience.--But now, what is our criterion for the experience's really having been transferred? "Well he simply has the same as I have"--But how does *he* 'have' it? [Cf. Z 433.]

Page 87

445. Think of the variety of physical experiments. We measure, e.g. temperature; but only within a certain general technique is *this* experiment a measuring of temperature.--So if we were interested in the multiplicity of (physical) measurements, I mean kinds of measurement, we'd be interested in the same way in the multiplicity of methods, of concepts.

Page 87

446. How can you *look at* your grief? By being grief-stricken? By not letting anything distract you from your grief? So are you observing the feeling by *having* it? And if you are holding every distraction at a distance, does that mean you are observing *this* condition? or the other one, in which you were *before* the observation? So do you observe your own observing?

Page 87

447. Suppose someone were to ask "What are all the things measured in physics?" Now one might retail them: lengths, times, brightness of light, weights etc.

But might one not say: You learn more if you ask "How is measuring done?" instead of "What is measured?"

If one does *this*, if one measures like *this*, then one is measuring temperature--if one does *that*, measures like *that*: the strength of a current.

Page 87

448. But doesn't grief consist of all sorts of feelings? Is it not a congeries of feelings? Then would one say it consists of feelings A, B, C, etc.--like granite out of feldspar, mica and quartz?--So do I say of someone who has the feelings... that he is grief-stricken? And how do I know that he has them? Does he tell us?

Page 87

449. But grief is a mental experience. One says that one experiences grief, joy, disappointment. And then these experiences seem to be really composite and distributed over the whole body.

Page Break 88

Page 88

The gasp of joy, laughter, jubilation, the thoughts of happiness--is not the experience of all this: joy? Do I know, then, that he is joyful because he tells me he feels his laughter, feels and hears his jubilation etc.--or because he laughs and is jubilant? Do I say "I am happy" because I feel all that?

Page 88

450. The words "I am happy" are a bit of the behaviour of joy.

Page 88

451. And how does it come about that--as James says--I have a feeling of joy if I merely make a joyful face; a feeling of sadness, if I make a sad one? That, therefore, I can produce these feelings by imitating their expression? Does that shew that muscular sensations are sadness, or part of sadness?

Page 88

452. Suppose someone were to say: "Raise your arm, and you will feel that you are raising your arm." Is that an empirical proposition? And is it one if it is said: "Make a sad face, and you will feel sad"?

Or was that meant to say: "Feel that you are making a sorrowful face, and you will feel sorrow"? and is that a pleonasm?

Page 88

453. Suppose I say: "Yes, it's true: if I adopt a more friendly expression, I feel better at once."--Is that because the feelings in the face are pleasanter? or because adopting this expression has consequences? (One says "Chin up!")

Page 88

454. Does one say: "Now I feel much better: the feeling in my facial muscles and round about the corners of my

mouth is good"? And why does that sound laughable, except, say, when one had, felt pain in these parts before?

Page 88

455. Is my feeling at the corners of the mouth compared with his--in the same way as my mood is compared with this?

How, for example, do I compare my sensations of pressure with his? How do I *learn* to compare them? How do I compare our kinaesthetic sensations, how do I correlate them with one another? And how the feelings of sorrow, joy etc.?

Page 88

456. Now granted--although it is extremely doubtful--that the muscular feeling of a smile is a constituent part of feeling glad;--where are the other components? Well, in the breast and belly etc.!--

Page Break 89

But do you really feel them, or do you merely conclude that they *must* be there? Are you really conscious of these localized feelings?--And if not--why are they supposed to be there at all? Why are you supposed to mean *them*, when you say you feel happy?

Page 89

457. Something that could only be established through an act of *looking*--that's at any rate not what you meant.

For "sorrow", "joy" etc. just are not used like that.

Page 89

458. Why does it sound so queer to say "He felt deep grief for one second"? Because it so seldom happens? Then what if we were to imagine people who often have this experience[[sic]]? Or such as often for hours together alternate between second-long feelings of deep grief and inner joy? [Cf. P.I. p. 174c.]

Page 89

459. "Don't you feel grief *now*..."--is that not as if one were to ask "Aren't you playing chess *now*?" Really, though, the question was a personal and temporal one, not a philosophical question. [Cf. p. 174d.]

Page 89

460. "'I'm hoping...'--the description of my state of mind": That sounds as if I looked into my mind and described it (as one describes a landscape). If now I say: "I keep on hoping that he will yet come to me"--is that a piece of hoping behaviour? Isn't it as little a piece of hoping behaviour as the words "At that time I was hoping he would come"? So should I not say that there are two kinds of present of "hope"? One, as it were the exclamation, the other the report?

Page 89

461. But now when I say to someone "I very much hope that he will come to our gathering"--does he ask me: "What was that, a report or an exclamation?" -Does he fail to understand me, if he doesn't know that? And yet it is one thing to say "I hope he'll come" and another to say: "I don't lose hope that he will come."

Or think of this expression "I hope and pray that he may come".

Page 89

462. "I hope he'll come"--one might say--is sometimes equivalent in meaning to "He'll be coming!" said in a hopeful voice. But this exclamation need not have any perfect tense. Couldn't a language be imagined in which, while there was an equivalent of this expression

Page Break 90

of hope, still there were not the remaining forms of the verb? In which the people quoted themselves when they did want to speak of past hope--saying, e.g. "I said: 'He'll surely come!'"

Page 90

463. It might be said: An assertion says something about the state of mind, given that I can make inferences from it about the state of mind. (That sounds more stupid than it is.) If *that's* how it is, then the expression of a wish "Give me that apple" says something about my state of mine. And is this proposition then a description of this state? That one won't want to say. ("Off with his head!")†1

Page 90

464. If I call out "Help!" is that a description of my state of mind? And is it *not* the expression of a wish? Is it not as much that as any other cry is?

Page 90

465. I say to myself "I still keep on and on hoping, although..." and in saying it I as it were shake my head over myself. That means something quite other than simply "I hope...!" (The difference in English between "I am hoping" and "I hope".)

Page 90

466. And what is observed by observing your own hope? What would you *report*? Various things. "I hope every

day.... I imagined.... Every day I said to myself.... I sighed.... Every day I took this route in the hope...."

Page 90

467. The word "observe" is badly applied here. I try to remember this and that.

Page 90

468. If someone remembers his hope, on the whole he is not therefore remembering his behaviour, nor even necessarily his thoughts. He says--he knows--that at that time he hoped.

Page 90

469. The sentence "I want some wine to drink" has roughly the same sense as "Wine over here!" No one will call *that* a description; but I can gather from it that the one who says it is keen to drink wine, that at any moment he may take action if his wish is refused--and this will be called a conclusion as to his state of mind.

Page 90

470. Is "I believe..." a description of my mental state?--Well, what is such a description? "I am sad", for example, "I am in a good mood", perhaps "I am in pain".

Page Break 91

Page 91

471. It would be asking for trouble to take Moore's paradox for something that can only occur in the mental sphere.

Page 91

472. I want to say first of all that with the assertion "Its going to rain" one expresses belief in that just as one expresses the wish to have wine with the words "Wine over here!" One might also put it like this: "I believe p" means roughly the same as "p" and it ought not to mislead us that the verb "believe" and the pronoun "I" come in the first proposition. We merely see clearly from this that the grammar of "I believe", is very different from that of "I write".

But when I say this, I don't mean that there may not also be big similarities here; and I am not saying what *kind* of differences there are. ((Real and imaginary unit.))

For remember that what is in question here are similarities and differences of concepts, not phenomena.

Page 91

473. One may say the following queer thing: "I believe it's going to rain" means something like: "It's going to rain", but "I believed then that it was going to rain" doesn't mean anything like "It rained then".

But now, what does it mean to say that the first sentence has roughly the same sense as the second? Does it mean that both produce the same thought in my mind (the same *feeling*?--[Cf. P.I. p. 190d.]

Page 91

474. "I want to think *thus* and not *thus*." And however queer it sounds '*thus*' and '*this*' aren't sharply distinct from one another.

Page 91

475. The way you use the word "God" shews, not *whom* you mean, but what you mean. [V.B. p. 99; C. & V., p. 50.]

Page 91

476. "But surely 'I believed' must mean just *that*, for the past, which 'I believe' means for the present!" $\sqrt{-1}$

must mean just the same for -1, as $\sqrt{1}$ does for 1. That means nothing at all. [Cf. P.I. p. 190d.]

Page 91

477. What does it mean to say that "I believe p" says roughly the same as "p"? We react in roughly the same way when anyone says the first and when he says the second; if I said the first, and someone didn't understand the words "I believe", I should repeat the sentence in the second form and so on. As I'd also explain the words "I wish you'd go away" by means of the words "Go away".

Page Break 92

Page 92

478. Moore's Paradox may be expressed like *this*: "I believe p" says roughly the same as " \vdash p"; but "Suppose I believe that p..." does not say roughly the same as "Suppose p...".

Can one understand the supposition that I wish for something before understanding the expression of a wish?--The child learns first to express a wish, and only later to make the supposition that it wished for such-and-such.

Page 92

479. "Suppose I have a pain..."--that is not an expression of pain and so it is not a piece of pain-behaviour.

The child who learns the word "pain" as a cry, and who then learns to tell of a past pain--one fine day this

child may declare: "If I have a pain, the doctors[[sic]] comes." Now has the meaning of the word "pain" changed in this process of learning the word? It has altered its employment; but one must guard carefully against interpreting this change as a change of object corresponding to the word.

Page 92

480. Imagine "I believe..." represented in a painting. How might I imagine this? The picture would perhaps shew *me* with some picture or other inside my head. The point is not what symbolism it employs. The picture of *what* I believe, e.g. that it is raining, will come into it. My mind will perhaps lay hold of this picture, hold on to it and so on.--And now let us suppose that this picture got used as the assertion "Its raining". Well, so far there is nothing odd about that. Am I now to say that there is a lot that is *redundant* about the picture? That I should not like to say.

Page 92

481. "Basically, with these words I describe my own state of mind--but *here* this description is indirectly an assertion of the state of affairs that is believed."--As, in certain circumstances I describe a photograph in order to describe what the photograph is a shot of. [Cf. P.I. p. 190e.]

Page 92

482. But if this analogy held good, then I should further have to be able to say that this photograph (the impression on my mind) is trustworthy. So I should have to be able to say: "I believe that it's raining, and my belief is trustworthy, so I trust it." As if my belief were a kind of sense-impression. [Cf. P.I. p. 190e.]

Page 92

483. Do you say, e.g. "I believe it, and as I am reliable, it will presumably be so"? That would be like saying: "I believe it--therefore I believe it."

Page Break 93

Page 93

484. Just as one may use the same procedure, now to measure the length of the table, now to check the yardstick, now to test the measurer's accuracy in making measurements, in the same way an assertion may serve one as information as to its content, or about the character or the state of mind of the asserter.

Page 93

485. One might very well say: "He's coming, but I still can't believe it!"--"He's coming! I can't believe it!"

Page 93

486. Imagine an announcer in a railway station, who announces a train according to schedule, but--perhaps groundlessly--is convinced that it won't arrive. He might announce: "Train No.... will arrive at... o'clock. Personally I don't believe it."

Page 93

487. How would it be, if a soldier produced military communiqués which were justified on grounds of observation; but he adds that he believes they are incorrect.--Let us ask ourselves, not what may be going on in the mind of one who speaks in this way, but rather whether others can do anything with this report, and what they can do.

Page 93

488. The communiqué is a language-game with these words. It would produce confusion if we were to say: the words of the communiqué--the proposition communicated--have a definite sense, and the giving of it, the 'assertion' supplies something additional. As if the sentence, spoken by a gramophone, belonged to pure logic; as if here it had the pure logical sense; as if here we had before us the object which logicians get hold of and consider--while the sentence as asserted, communicated, is what it is in *business*. As one may say: the botanist considers a rose *as a plant*, not as an ornament for a dress or room or as a delicate attention. The sentence, I want to say, has no sense outside the language-game. This hangs together with its not being a kind of *name*. As though one might say "I believe..."--*that's* how it is" pointing (as it were inwardly) at what gives the sentence its meaning.

Page 93

489. Is it a tautology to give the communiqué: "The cavalry will arrive immediately, and I believe it"?

Page 93

490. The paradox is this: the *supposition* may be expressed as follows: "Suppose *this* went on inside me and *that* outside"--but the *assertion*

Page Break 94

that *this* is going on *inside* me asserts: this is going on outside me. As *suppositions* the two propositions about the inside and the outside are quite independent, but not as assertions.

Page 94

491. Does this lie in the nature of the concept "believe"? Certainly.

Page 94

492. Suppose someone said "I wish--but I don't want my wish to be fulfilled". (Lessing: "If God in his right hand...."†1) Can one then ask God to give the wish, and *not* to fulfil it?

Page 94

493. So it looks as if the assertion "I believe..." were not the assertion of what the supposition "I believe" supposes! [Cf. P.I. p. 190c.]

Page 94

494. Don't see it as a matter of course, but as something very worthy of note, that the verbs "believe", "hope", "wish", "intend" and so on, exhibit all the grammatical forms that are also possessed by "eat", "talk", "cut". [Cf. P.I. p. 190h.]

Page 94

495. Imagine I were the hybrid being that might pronounce "I don't believe it is raining; and it is raining".--But what purpose do these words now serve? What employment am I imagining being given to them?

"He's coming. I personally don't believe it, but don't let that mislead you." "He's coming, rely upon it. I don't believe it, but don't let that mislead you." This sounds as if two persons were speaking out of me; or as if one court within me gave the other person the information that so and so was coming, and this court wished that the person should take appropriate action--while another court in a certain sense reported my own attitude. It is as if one were to say "I know that this is the wrong procedure, but I know that that's what I shall do".

"He's coming, but I don't believe it" may, then, occur in a language-game. Or better: It is possible to think out a language-game in which these words would not strike us as absurd.

Page Break 95

Page 95

496. A voltmeter might *pronounce* the voltage by means of a gramophone record instead of by dial and pointer. When one presses a button (asks the question) the instrument says, e.g. "The voltage amounts to...". Could it make sense to have the voltmeter say: "I believe the voltage amounts to..."? One can imagine such a case.

Am I now to say that the instrument is stating something about itself--or about the voltage? Am I to say that the instrument *always* states something about itself! And if, e.g., on repetition it may give a higher reading for the voltage: am I to say that it had *believed* the voltage was...?

Page 95

497. Or let us put it like this: Am I to say a voltmeter says something about itself, or about the voltage? May I not say both? Each, that is, under different circumstances?

Page 95

498. Have "Help!" and "I need help" different senses; is it merely a crudity in our conception that we regard them as equivalent? Does it always mean something to say "Strictly speaking, what I meant was not 'Help!' but 'I need help'".

The worst enemy of our understanding is here the idea, the picture, of a 'sense' of what we say, in our mind.

Page 95

499. The assertion "He will come" makes no allusion to the maker of the assertion. But neither does it allude to the words of the assertion, whereas "'He will come' is a true proposition" does allude to the words and has the same sense as the proposition that does not do so.

Page 95

500. Might one speak of the sense of the words "that he will come"? For these words are precisely the Fregean 'assumption'. Well, couldn't I explain to someone what this verbal expression means? Yes I can, by explaining to him, or shewing him, how it is employed.

Page 95

501. The difficulty becomes insurmountable if you think the sentence "I believe..." states something about the state of my mind. If it were so, then Moore's Paradox would have to be reproducible if, instead of saying something about the state of one's own mind, one were making some statement about the state of one's own brain. But the point is that no assertion about the state of my (or anyone's) brain is equivalent to the assertion which I believe--for example, "He will come".

Page Break 96

Page 96

502. But now, we do nevertheless take the assertion "He believes p" as a statement about his *state*; from this indeed there results his way of going on in given circumstances. Then is there no *first person present* corresponding to such an ascription? But then, may I not ascribe a state to myself now in which such-and-such linguistic and other reactions are probable? It is like this, at any rate, when I say "I'm very irritable at present". Similarly I might also say

"I believe any bad news very readily at present".

Page 96

503. Now would a proposition ascribing to myself--or to my brain such a condition that I reply "Yes" to the question "Will he come?" and also exhibit such-an-such other reactions--would such a proposition amount to the assertion "He will come"?

Here one might ask "How do you imagine I have been instructed about this state of mind?--By experience, say? Do I then want to predict from experience that I will now always answer such a question like *this*, etc.?" If that's how it is, and I make the statement "I believe he will come" in this sense, and I add "and he isn't going to come", then that is a contradiction only to the same extent as "I'm incapable of pronouncing any word with four syllables"; or "I can't speak a word of English".

If this latter is a kind of contradiction; still the assumption "Suppose I couldn't speak a word of English" is not.

Page 96

504. That he believes such-and-such, *we* gather from observation of his person, but *he* does not make the statement "I believe..." on grounds of observation of himself. And *that* is why "I believe p" may be equivalent to the assertion of "p". And the question "Is it so?" to "I'd like to know if it is so."

Page 96

505. "This face has a quite particular character"--really means: *much* could be said about it. When does one say this? What justifies one in it? Is it a particular experience? Does one already know what one will say: has one already said it silently? Isn't it a situation like: "Now I know how to go on!"

Page 96

506. We all know the process of sudden change of aspect;--but what if someone asked: "Does A have the aspect *a* continuously before his eyes--when, that is, no change of aspect has taken place?" May not

Page Break 97

the *aspect* become, so to speak, *fresher*, or *more indefinite*?--And how queer it is that I *ask* this!

Page 97

507. There is such a thing as the flaring up of an aspect. In the same way as one may play something with more intense and with less intense expression. With stronger emphasis of the rhythm and the structure, or less strong.

Page 97

508. Seeing, hearing *this* as a variant of *that*. Here there is the moment at which I *think* of B at the sight of A, where this seeing is, so to speak, acute, and then again the time in which it is chronic.

Page 97



509. *Not* to explain, but to *accept* the psychological phenomenon--that is what is difficult.

Page 97

510. "F" as a variation of different figures.

If I imagine that the paradigm, as a variant on which I see the object, is somehow present in my mind as I see, then it might after all be present now more clearly, now less, and it might disappear altogether.

Page 97



511. Imagine two people: one has learnt "F" like this in his youth: "  "--the other, as we do: "  ". If now both read the word "Figure",--must I say, have I reason to say, that they each see the "F" differently? Obviously not. And yet might it not still happen, that the one, on hearing how the other learned to write and read this letter, says: "I've never seen it like *that*, but always like *this*"?

And further, there will probably be situations in which I shall explain what one of these people does or says like *this*: "The thing is, he regards this letter as a variant of..."

Page 97

512. *This* is certain, that one may say: "I've never seen this in that way before." Here there is no doubt about the "never".--But if you say "I have *always* seen this like that", this "always" is not equally certain. And there is of course nothing at all remarkable about this, if instead of "seen" one says "taken".

Page 97

513. Suppose you knew that the sign  was a combination of a  with a  .--This recalls the dream phenomenon, which, in

Page Break 98

telling a dream, one describes with the words: "and I knew that...". And it also has some similarity to what is called

"hallucination".

Page 98

514. It is as if when I see the written character there were a paradigm, a pattern, present in my mind. But what sort of pattern?? What does it look like? Surely at any rate not like the character itself!--Well, like the character seen in *this* way then? But seen in *what* way? What notation can I use for the aspect? Well, what notation do we use; how do we communicate about it? I say, for example: "The sign, as I see it, looks to the right." I might positively speak of a kind of visual centre of gravity,--might say: The centre of gravity of the sign F is *here*. Can I explain what I mean by this? No.--But I can compare this reaction of mine with other people's reactions.

Page 98

515. Am I continually conscious that the edges of my visual field are blurred? Ought I to say: "Hardly ever", or "never"?

Page 98

516. In a different thought-space--one would like to say--the thing looks different.

Page 98



517. In music a variation on a theme could be imagined, which, phrased a bit differently, say, can be conceived as a completely different kind of variation of the theme. (In rhythm there are such ambiguities.) Indeed what I mean is probably to be found absolutely always, when a repetition makes the theme appear in a quite different light.

Page 98

518. No aspect that is not (also) conception.

Page 98

519. Suppose someone said to me: "Something has changed about the *picture* now--I can't put it in any other

way--although the shape is the same as before. I can only say: before, it was a kind of , now it's a kind of ." If he were to say *that*, might I not all the same be suspicious and doubt that he had always, uninterruptedly, *seen* the figure in that way, and not merely never conceived it otherwise?

Page 98

520. Imagine that a child, when it has learnt the letter "R", were to say to us "I always see it as an 'R'". What could that tell us??--For that matter, even if it were to say "I always see it as a 'P' with a skew support" that would only tell us: the child conceives it so, that's how it explains the letter to itself, and such like. Only if it were to speak of a change of the aspect should we say: now it is that phenomenon....

Page Break 99

Page 99

521. If someone says "I always see it *this* way", he must say how. Suppose he did this by tracing the lines of the figure in a definite order or in a particular rhythm. That would be something *like* his telling us "I always follow the figure with my eyes in *this* way". And here it might of course be that his memory deceives him.

Page 99

522. If he says "I see the figure (now) like *this*" and follows it in a definite way this need not be so much a description as, so to speak, the seeing itself. But if he says "I *have* always seen it like that" this means that he has never seen it *differently*, and here he may be deceiving himself.

Page 99

523. No, I didn't have the paradigm continuously before my mind--but when I describe the change of aspect, I use the paradigms in describing it.

Page 99

524. "I've always seen it *this* way"--here one really means to say: "I have always conceived it *this* way, and *this* change of aspect has never taken place."

Page 99

525. "I've never seen it *this* way, always *that*." Only this doesn't make a proposition by itself. It lacks a field.

Page 99

526. "I have always seen it with *this* face." But you still have to say *what* face. And as soon as you add *that*, it's no longer as if you had *always* done it.

"I have always seen this letter as having a peevish face." Here one can ask: "Are you sure it was *always*?" That is to say: did the peevishness *always* strike you?

Page 99

527. And what about something's 'striking' one? Does that take place in a moment, or does it last?

Page 99

528. "When I look at him, I always see his father's face." Always?--But surely not just *momentarily*! This aspect may endure.



529. Imagine its being said: "Now I always see it in *this* context."-

530. Absolute and relative pitch: Here is something similar: I hear the transition from one note to the other. But after a short time I can no longer recognize a note as the higher or lower of those two. And it

doesn't even have to make sense to speak of any such "recognition"; when, that is, there is no criterion for correct recognition.

531. It is almost as if the '*seeing* of the sign in *this* context' were an echo of a thought. [Cf. P.I. p. 212b.]

532. To say of a real face, or of a face in a painting: "I've *always* seen it as a face" would be queer; but not "It has always been a face for me, and I have never seen it *as something else*".

533. If, e.g., for once I see the  as a T with an additional stroke, it is as if the *grouping* changed. But if I am asked: "So formerly you always saw this figure with the grouping of an ?" I could not say it was so.

534. If someone says: "I am talking of a visual phenomenon, in which the visual picture, that is its organization, does change, although shapes and colours remain the same"--then I may answer him: "I know what you are talking about: *I too should like to say* what you say."--So I am not saying "Yes, the phenomenon we are both talking about is actually a change of organization..." but rather "Yes, this talk of the change of organization etc. is an expression of the experience which I mean too".



535. "The organization of the visual image changes."--"Yes, that's what I'd like to say too."

This is analogous to the case of someone saying "Everything around me strikes me as unreal"--and someone else replies: "Yes, I know this phenomenon. That's just how I'd put it myself."

536. "The organization of the visual image changes" has not the same kind of application as: "The organization of this company is changing." *Here* I can describe *how it is*, if the organization of our company changes.

537. "It never occurred to me that one can see the figure *this* way": does it follow that it did occur to me, or that I knew, that one could see it the way I always have seen it?

538. I hear a note--so don't I hear how loud it is?--Is it correct to say: if I hear the note, I must be conscious of its degree of loudness? It's different if its strength alters.

539. At first sight it would appear to be like *this*: Someone notices that one can see an  also as a T with a little appendix; he says "Now I see it as a T etc., now as an F". From this it seems to follow that he sees it the second time as he *always* saw it before his discovery.--And so, that if it makes sense to say "Now I see it as an F again", it also made sense to say, before the change of aspect, "I always see the letter  as an F".

540. If I had always heard a sentence in one and the same intonation (and often heard it) would it be right to say that I must, of course, have been conscious of the intonation? If that just means that I have heard it in this intonation and also pronounce it accordingly--then I am conscious of the intonation. But I need not know that there is such a thing as an 'intonation'; the intonation need never have *struck* me, I need never have *hearkened to it*.

The concept intonation may be quite unknown to me. The '*separation*' of intonation from sentence need not have been effected for me.

I have not learned any language-game with the word "intonation"!

541. For when a child learns its letters, it doesn't learn to see them *this* way and not otherwise. Am I to say, now,

that at the change of aspect the man realizes that he has always seen a letter, say an R, in the same way?--Well, it *might* be so, but it isn't so. No, *that's not what we say*. Rather, when someone says something like: for him the letter... has always had such-and-such a face, he would admit that in many cases he has not 'thought' of a face when he saw the letter.

Page 101

542. Am I now to say: a 'kind of seeing' is associated with a letter for us? Certainly not; unless it means something like: a face gets associated with a letter.

Page 101

543. Think of the concept "style of handwriting" one may say "That's an interesting style that the letter... is written in"--but does everyone who has learnt how to write a letter of the alphabet understand what "style" means? I mean: Can someone understand the style

Page Break 102

of the letter S who doesn't know at all that there is such a thing as different styles for a letter?--Or am I merely playing with words here?

You just must not have too narrow a concept of 'experiencing'.

Ask yourself, e.g.: The man who has never had other examples before him--can *he* perceive a pronunciation as *vulgar*?

Page 102

544. "I find this handwriting unattractive." If someone has only just learnt to read and write, can he find a handwriting 'unattractive'?--It may perhaps in some sense put him off. It makes sense to say that someone finds a handwriting unattractive, only if he is already capable of forming all sorts of thoughts about a handwriting.

Page 102

545. Would it be imaginable, given two identical bits of a piece of music, to have directions placed above them, bidding us hear it like *this* the first time, and like *this* the second, without this exerting any influence on the performance? The piece would perhaps be written for a chiming clock and the two bits would be meant to be played equally loud and in the same tempo--only *taken* differently each time.

And, even if a composer has never yet written such a direction, might not a critic write it? Would not such a direction be comparable to a title to Programme music ("Dance of the Peasants")?

Page 102

546. Only of course, if I say to someone "Hear it like *this*", he must now be able to say: "Yes, now I understand it; now it really makes sense!" (Something must click.)

Page 102

547. What concept have we of sameness, of identity? You are familiar with the uses of the word "same" when what is in question is same colours, same sounds, same shapes, same lengths, same feelings, and now you decide whether this case and that should be included in this family or not.

Page 102

548. What is it that is repulsive in the idea that we study the use of a word, point to mistakes in the description of this use and so on? First and foremost one asks oneself: How could *that* be so important to us? It depends on whether what one calls a 'wrong description' is a description that does not accord with established usage--or one which does not accord with the practice of the person giving the description. Only in the second case does a philosophical conflict arise.

Page Break 103

Page 103

549. Less repulsive is the idea that we form *a wrong picture* for ourselves, say of thinking. For here one says to oneself: at least we have to do with thinking, not with the word "thinking".

So we form a wrong picture of thinking.--But *of what* do we form a wrong picture; how do I know, e.g., that you are forming a wrong picture of *that*, of which I too am forming a wrong picture?

Let us suppose that our picture of thinking was a human being, leaning his head on his hand while he talks to himself. Our question is not "Is that a correct picture?" but "How is this picture employed as a picture of thinking?"

Say, not: "We have formed a wrong picture of thinking"--but: "We don't know our way about in the use of our picture, or of our pictures." And hence we don't know our way about in the use of our word.

Page 103

550. Very well,--but this word is surely interesting to us only insofar as it actually possesses for us a quite particular use, and so already relates to a particular phenomenon!--That's true. And that means: our concern is not with improving grammatical conventions.--But what does it mean to say "We all know what phenomenon the word

'thinking' refers" to? Doesn't it simply mean: we can all play the language-game with the word "think"? Only it produces unclarity to call thinking a 'phenomenon', and further unclarity to say "we form a wrong picture of this phenomenon". (One might really rather say "a wrong concept".)

Page 103

551. If we are dealing with the use of the word "five", then we are dealing in a certain sense with what "corresponds" to the word; only *this* way of speaking is primitive, it presupposes a primitive conception of the use of a word.

Page 103

552. A 'language game': We get someone to choose an aroma according to a drawing, e.g. the aroma of coffee. We



say to him "Coffee smells like this: " and now we tell him to bring the liquid that smells like that--Now I will assume that he would actually bring the right one. So I would have a means of imparting orders to a human being by *graphical* means. ((Connexion with the nature of a rule, a technique, of mathematics,--that of the real numbers for example.)) This also hangs together with this: ("The mother hen 'calls' the chickens to her").

Page Break 104

Page 104

553. "One can't describe the aroma of coffee." But couldn't one imagine being able to do so? And *what* does one have to imagine for this?

If someone says: "One can't describe the aroma," one may ask him: "What *means* of description do you want to use? What *elements*?"

Page 104

554. We are not *prepared* for the task of describing the use of the word "think", for example. (And why should we have been? What use is such a description?)

And the naïve conception that one forms of it does not correspond to the reality at all. We expect a smooth regular contour and get to see a ragged one. Here one might really say that we had formed a wrong picture. It is like this: suppose there were a substantive, let's say "giant", used to express all that we say by means of the word "big". The picture that would come to our minds in connexion with the word "giant" would be that of a giant. And now suppose that our queer employment of the word "big", with this picture before our eyes, had to be described. [Cf. Z 111.]

Page 104

555. Macaulay says that the art of fiction is an "imitative art", and naturally gets straight away into the greatest difficulties with this concept. He wants to give a description: but any picture that suggests itself to him is inappropriate, however right it seems at first sight; and however queer it seems that one should be unable to describe what one so exactly understands.

Here one tells oneself: "It *must* be like this!--even if I cannot immediately get rid of all the objections."

Page 104

556. It is very easy to imagine someone knowing his way about a city quite accurately, i.e. he finds the shortest way from one part of the city to another quite surely--and yet that he should be perfectly incapable of drawing a map of the city. That, as soon as he tries, he only produces something completely wrong. (Our concept of 'instinct'.) [Z, 121.]

Page 104

557. Above all, someone attempting the description lacks any system. The systems that occur to him are inadequate, and he seems suddenly to find himself in a wilderness instead of in the well laid out garden that he knew so well.

Rules occur to him, no doubt, but the reality shews nothing but exceptions.

Page Break 105

Page 105

558. And the rules of the foreground make it impossible for us to recognize the rules in the background. For when we keep the background together with the foreground, we see only jarring exceptions, in other words *irregularity*.

Page 105

559. Do we say that *anyone* who talks sense is thinking? E.g. the builder in language-game (2)?†1 Might we not imagine the building and the calling out of the words etc. in a surrounding in which we should not connect them up with any thinking?

For "thinking" is *akin* to "considering". [Cf. Z, 98.]

Page 105

560. "Carrying out a multiplication mechanically" (whether on paper or in the head): that is something we do say-but

"considering something mechanically": for us, that contains a contradiction.

Page 105

561. The expression, the behaviour, of considering. Of what do we say: It is considering something? Of a human being, sometimes of a beast. (Not of a tree or a stone.) *One* sign of considering is hesitating in what you do (Köhler). (Not just *any* hesitation.)

Page 105

562. Think of the 'considering' in 'trying'. In 'investigating'; in the expression of astonishment; of failure and of success.

Page 105

563. What a lot of things a man must do in order for us to say he *thinks*!

Page 105

564. He cannot *know* whether I am thinking, but I know it. What do I know? That what I am doing now is *thinking*? And what do I compare it with in order to know that? And may I not be mistaken about it? So all that is left is: I know that I am doing what I am doing.

Page 105

565. But it surely makes sense to say. "He does not know what I thought, for I did not tell him!"

Is a thought also 'private' in the case where I utter it out loud in talking to myself, if no one hears me?

"My thoughts are known to myself alone."

But what that means is, roughly: "I *can* describe them, can express them *if* I want to."

Page Break 106

566. "Only I know my thoughts."--How do you know that? Experience did not teach you it.--What do you tell us by saying so? You must be expressing yourself badly.

"Not so! I am now thinking something to myself; tell me what it is!" So was it after all an empirical proposition? No; for, if I were to tell you what you are thinking to yourself, I would only be *guessing* it. How is it to be decided whether I have guessed right? By your word, and by certain circumstances: So I am comparing this language-game with *another* one, in which the means of deciding (verification) look different.

Page 106

567. "Here I cannot...."--Well, where *can* I? In another game. (Here--that is in tennis--I cannot shoot the ball into goal.)

Page 106

568. But isn't there a connexion between the grammatical 'privacy' of thoughts and the fact that we generally cannot guess the thoughts of someone else before he utters them? But there is such a thing as guessing thoughts in the sense that someone says to me: "I know what you have just thought" (or "What you just thought of") and I have to admit that he has guessed my thoughts right. But in fact this happens very seldom. I often sit without talking for several minutes in my class, and thoughts go through my head; but surely none of my audience could guess what I have been thinking to myself. Yet it would also be possible that someone should guess them and write them down just as if I had uttered them out loud. And if he shewed me what he had written, I should have to say "Yes, I thought just that to myself."--And here, e.g., this question would be undecidable: whether I am not making a mistake; whether I really thought that, or, influenced by his writing, I am firmly *imagining* myself to have thought precisely that.

And the word "undecidable" belongs to the description of the language-game.

Page 106

569. And wouldn't *this* too be conceivable: I tell someone "You have just thought... to yourself"--He denies it. But I stick to my assertion, and in the end he says: "I believe you are right; I must have thought that to myself; my memory must be deceiving me."

And now imagine this being a quite ordinary episode!

Page 106

570. "Thoughts and feelings are private" means roughly the same as "There is pretending", or "One can hide one's thoughts and feelings; can even lie and dissimulate". And the question is, what is the import of this "There is..." and "One can".

Page Break 107

Page 107

571. Under what circumstances, on what occasions, then, does one say: "Only I know my thoughts"?--When one might also have said: "I am not going to tell you my thoughts" or "I am keeping my thoughts secret", or "You people

could not guess my thoughts".

Page 107

572. Of what does one say that one is *acquainted* with it? and to what extent am I acquainted with my thoughts?

Don't we say that one is acquainted with what one can give a correct description of? And can one say that of one's own thoughts?

If someone wants to call the words the "description" of the thought instead of the "expression" of the thought, let him ask himself how anyone learns to describe a table and how he learns to describe his own thoughts. And that only means: let him look and see how one judges the description of a table as right or wrong, and how the description of thoughts: so let him keep in view these language-games in all their situations.

Page 107

573. "But the fact is that a human being knows only his *own* thoughts." ("But the fact is that only I know of my own thinking.")

"And I don't either," one might say.

Page 107

574. "Nature has given it to man to be able to think in secret." Imagine its being said; "Nature has given it to man to be able to talk audibly, but also to be able to talk inaudibly, within his mind." So, that means, he can do the same thing in two ways. (As if he could digest visibly and also digest invisibly.) Only with speaking within one's mind the speaking is hidden better than any process within one's body can possibly be.--But how would it be if I were to speak, and everyone else were deaf? Wouldn't my speaking be equally well hidden?

Page 107

"It all goes on in the deepest secrecy of the mind."

Page 107

575. If someone *says* to me what he has thought--has he really said: what he *thought*? Would not the actual mental event have to remain undescribed?--Was *it* not the secret thing,--of which I give another a mere picture in speech?

Page 107

576. If I *say* what I *think* to someone,--do I know my thought here better than my words represent it? Is it as if I were acquainted with a *body* and shewed the other a mere photograph?

Page Break 108

Page 108

577. "Man has the gift of speaking with himself in total seclusion; in a seclusion far more complete than that of a hermit." How do I know that N. has this gift?--Because he says so and is trustworthy?--

Page 108

And yet we do say: "I'd like to know what he is thinking to himself now," quite as we might say: "I'd like to know what he's writing in his notebook now." Indeed, one might say *that* and so to speak see it as obvious that he is thinking to himself what he enters in his notebook.

Page 108

578. If there were people who could *regularly* read a man's thoughts say by observation of his larynx--would they too be inclined to speak of the total solitude of the spirit within itself?--Or: Would they too be inclined to use *that picture* of 'total seclusion'?

Page 108

579. "I'd like to know what he's thinking of." But now ask yourself this--apparently irrelevant--question: "Why does what is going on in him, in his mind, interest me at all, supposing that something is going on?" (The devil take what's going on inside him!)

Page 108

580. In philosophy, the comparison of thinking to a process that goes on in secret is a misleading one.

As misleading as, e.g., the comparison of searching for the appropriate expression to the efforts of someone who is trying to make an exact copy of a line that only he can see.

Page 108

581. What confuses us is that knowing the thoughts of another from one angle is logically impossible, and from another it is psychologically and physiologically impossible.

Page 108

582. Is it right to say: these two 'impossibilities' connect up with each other in such a way that the psychological impossibility (here) supplies us with the picture that (then) becomes for us the mark of the concept 'thinking'?

Page 108

583. One cannot say: writing in one's notebook or speaking in monologue is *'like'* silent thinking; but for certain purposes the one process can *replace* the other (e.g. calculating in the head can replace calculating on paper).

584. Might there be people who always mutter to themselves as they think, so that their thinking is accessible to others?--"Yes, but we still could not know whether they don't think silently to themselves as

well."--But then might it not be that it was just as senseless to suppose this as to suppose that these people's hairs were thinking, or a stone was thinking? That is to say: if this were so, need it so much as occur to us that someone thought, that he had thoughts, hidden in his mind?

585. "I don't know what you are thinking to yourself. Say what you are thinking."--That means something like "Talk!"

586. Then is it misleading to speak of man's soul, or of his spirit? So little misleading, that it is quite intelligible if I say "My soul is tired, not just my mind". But don't you at least say that everything that can be expressed by means of the word "soul", can also be expressed somehow by means of words for the corporeal? I do not say that. But if it were so--what would it amount to? For the words, and also what we point to in explaining them, are nothing but instruments, and everything depends on their use.

587. Our knowledge of different languages prevents us from really taking seriously the philosophies laid down in the forms of each of them. But at the same time we are blind to our own strong prejudices for, as against, certain forms of expression; to the fact that just this piling up of several languages results in a special picture. That, so to speak, it is not optional for us which form we cover up with which.

588. You must remember the possibility of a language-game of 'continuing a series of figures', in which no rule, no expression of a rule is ever given, but the learning is done *only* by means of examples. So that the idea that each step can be justified by a somewhat--a kind of model--in our mind would be entirely alien to these people. [Cf. Z 295.]

589. Example of the names that have meaning only when accompanied by their bearers, i.e. that is the only way they are used. So they serve merely to avoid continual pointing. The example that always comes to my mind is the designation of lines, points, angles by A, B, C... a, b... etc., in geometrical figures.

590. In reading: seeing the picture of the word: "I saw the word fleetingly"--that is a special experience, it cannot be portrayed on film.

591. Imagine a mental illness, in which one can use and understand names only in the presence of their bearers. [Cf. Z 714.]

592. There could be a use made of signs, of such a kind that the signs became useless (that one perhaps destroyed them) as soon as the bearers ceased to exist.

In this language-game the name would have to have the object as it were on a lead; and when the object ceases to exist, one can throw away the name which has worked in connexion with it. [Cf. Z 715.]

593. "I intend to go there": is the state of mind being *described* or *voiced*?--If one imagines a model of the mind, then the sentence might be a description of the model in its present state. The human being looks at his mind and says:... Is it a good model or a bad one?--How should that be decided? The question is: How would it be *employed* as a sign?

594. "I intend..." *might* be used as an assertion: "I am doing something that is in accordance with this intention", e.g.: I am packing for the journey, getting myself ready for the journey in this way or that, by means of considerations or actions. One *might* use a verb in that way. Perhaps corresponding to the expression: "I am acting with the intent...."

595. Description of my state of mind: the alternation of fear and hope, e.g. "In the morning I was full of hope, and then...". Anyone would call that a description. But it is characteristic of it, that this description could run parallel to a description of my behaviour.

596. Compare the expression of fear and hope with that of 'belief' that such-and-such will happen.--That is why hope and fear are counted among the emotions; belief (or believing, however, is not.

Page 110

597. If I say: "The intention to do it grew stronger every hour," this will be called a description. But in that case so surely will *this* as well: "I intended the whole time...."

Page Break 111

Page 111

Now compare: "The whole time, I believed in the law of gravity" with "The whole time, I believed I heard a low whisper." In the first case "believe" is used similarly to "know". (*Had* anyone asked me, I *would have* said...) In the second case we have activity, surmising, listening, doubt etc. And even if "believe" does not *designate* these activities, still they are surely what makes us say that here we are *describing* a state of mind or a mental activity. We may also put it like this: we form a picture of the man who believes the whole time that he is hearing a low rustle. But not of the man who believes in the correctness of the law of gravity.

Page 111

598. I intend (it might be said) doesn't mean: "What I am at, is intending," or "I am engaged in intending" (as one says, I am engaged in reading the newspaper). On the other hand: "I am engaged in planning my journey" etc.

We have not, but might have, a single verb (and perhaps it actually exists in some little-known language) which expresses: "to act and think with such-and-such an intention."

Page 111

599. "I intend..." is *never* a description, but in certain circumstances a description can be derived from it.

Page 111

600. Talking to oneself. "What happens here?" Wrong question! It's not just that one can't say what happens--one can't say either that one doesn't know what happens, and one can't even say that one only knows this and that about it! But even this is wrong to say: It just is a specific process, which can't be described except in just these words. The concepts 'description' and 'report'. One says: Someone reported that he had said to himself... How far is that comparable to the 'report' that he had, e.g. said...? Let us make ourselves realize that *describing* is a very special *language-game*.--We have to dig around this hard substratum of our concepts.

Page 111

601. Concepts *may* mitigate or aggravate a mischief; favour it, or hamper it. [V.B., p. 108; C. & V., p. 55.]

Page 111

602. Quite right: one can't imagine any explanation of "red" or of "colour". Not, however, because what is experienced is something specific, but rather because the language-game is so.

Page 111

603. "One can't explain what *red* is to anyone." But suppose one could--is it in that case not what we call "red"?

Page Break 112

Page 112

Let us imagine men who express an intermediate colour, between red and yellow, e.g., by means of a kind of binary decimal fraction like this: R,LLRL and the like, where, e.g., yellow stands to the right, and red to the left.--Already in their nursery schools these people learn how to describe shades of colour in this way: they learn how to choose colours according to such descriptions, and they learn to mix them etc. They would stand to us roughly in the relation of people with absolute pitch to people in whom this is wanting. *They can do* what we can't. [Cf. Z 368.]

Page 112

604. And here we feel like saying: "Now, is that even imaginable? The *behaviour*, to be sure! But the inner process, the colour experience, as well?" And it is difficult to see what one should say to such a question. If we had not yet encountered people with absolute pitch, would the existence of such people strike us as very probable? [Cf. Z 369.]

Page 112

605. If someone were to say "Red is composite"--we should not be able to guess what he was alluding to, what he will be trying to do with this sentence. But if he says: "This chair is composite" although we may not know what kind of composition he is speaking of, still we can at once think of more than one sense for his assertion.

Now what kind of fact is this, that I am drawing attention to here?

Page 112

At any rate it is an *important* fact.--We are not familiar with any technique, to which that sentence might be alluding. [Cf. Z. 338.]

Page 112

606. Here we describe a language-game that we *cannot learn*. [Z 339.]

Page 112

607. "In that case something quite different must be going on in him, something that we are not acquainted with."--This *shows us* what we go by in determining whether something different from or the same as what goes on in us is going on 'in someone else'. This shows us *what we go by* in judging of inner processes. [Cf. Z 340.]

Page 112

608. "Red is not composite!" And what is red?--Here we should like simply to point to something red; and we forget that if that statement is to make sense we must be given more than the ostensive definition. We don't yet understand at all what is the sense of a sentence of the form "X is not composite", if X is replaced by a word having the use of our colour words.

Page Break 113

Page 113

609. It is a fact: "Red" does not get explained to anyone by means of words without reference to a sample of the colour. Shouldn't that be important?

Page 113

610. "How could one explain red to someone, since it is after all a particular sense-impression, known only to him who has it (or has had it)--and explaining can only mean: *producing* it in the other person."--

Page 113

611. "Someone who has absolute pitch must have a different experience of notes from what I have." And must everyone who has absolute pitch have the same experience? And if not, then why must it be a different one from mine?

Page 113

612. Imagine that, in order to explain 'red' to someone, we shew him a reddish dark brown, and say: "This colour consists of yellow (we shew pure yellow) black (se[[sic]] shew it), and one more colour which is called 'red'." Thereupon let him be competent to pick pure red out of a number of colour samples.

Page 113

613. And note this: one doesn't point to red, but to something red. That is of course to say: the concept 'red' is not determined by pointing, and now it is possible not only to interpret "red" as, e.g. the name of a shape, but also as a concept-word that comes *much closer* to a colour word than that.

Page 113

614. The *employment* of a word is not: to *designate* something.

Page 113

615. Can you imagine what a red-green colour-blind man sees? Can you paint a picture of the room as he sees it? [Cf. Z 341.]

Page 113

616. "If someone saw everything only black, white and grey, he would have to be *given* something, in order to know what red, green etc. are." And what would he have to be given? Well, the colours. And so, e.g. *this* and *this* and *this*. (Imagine, e.g., that coloured patterns had to be introduced into his brain, in addition to merely grey and black ones.) But would that have to happen as a means to the end of future action? Or are these patterns actually involved in this action? Do I want to say; "Something would have to be given him, for it is clear that otherwise he could not..."--or: His seeing behaviour *includes* new components?

Again what would we *call* an "explanation of seeing"? Is one to say: Well, you know what explanation means otherwise; so apply this concept here too? [Cf. Z 342-3.]

Page Break 114

Page 114

617. Can I say: "Look at it! Then you will see that it can't be explained."--Or: "Drink in the colour red, then you will see that it can't be represented by means of anything else!"?--And if the other now agrees with me, does that shew that he has drunk in the same as I?--And what is the significance of our inclination to say this? Red seems to be there, isolated. Why? What is the value of this seeming, of this inclination? [Cf. Z 344.]

Page 114

618. Think of the sentence "Red is not a blended colour," and of its function.

For the language-game with colours is characterized by what we are able to do, and what we are not able to do. [Cf. Z 345.]

Page 114

619. Red is something specific; but we don't see that when we look at something red. Rather we see the *phenomena*

that we *limit* by means of the language-game with the word "red".

Page 114

620. "Red is something specific," that must be as much as to say: "*That* is something specific" while pointing at something red. But for that to be intelligible, one would already have to mean our *concept* 'red', the use of that sample. [Cf. Z 333.]

Page 114

621. If you wonder at these things, wonder first at something else! Namely, at what is actually accomplished by description and report. If you concentrate your wonderment on this, those other problems will shrink.

Page 114

622. Primary colours. Suppose the colours that we call blends were among other men to play the role of our primary colours; should we say that *their* primary colours were, for example, this orange,--this bluish red, this bluish green, etc.? Then does the proposition "red is a primary colour" come to this: red plays such-and-such a role among us; we react to red, yellow etc. in this and that way?--Mostly one does not think so: that is to say, "Red is a pure colour" is a proposition about the 'essence' of red, time doesn't come into it; one cannot imagine that this colour might not be simple.

Page 114

623. The colour-circle: the equal distances of the primary colours are arbitrary. Indeed, the transitions would perhaps make a more uniform impression on us, if, e.g., the pure blue were nearer to the pure green than to the pure red. It would be very remarkable if the equality of the distances lay in the nature of the things.

Page Break 115

Page 115

624. "There's no such thing as a reddish green" is akin to the propositions that we use as axioms in mathematics. [Cf. Z 346.]

Page 115

625. Men count and calculate: Describe what they do here. Ought this description to include sentences like *this* one: "Now he understood how he had to continue the series"--or: "He is now able to do any arbitrary multiplication"? And is *this* proposition to be counted in: "He saw the whole number-series in his mind's eye"?

Such sentences may occur in the description: but may we not require that their use be explained to us; so that no false or irrelevant images sneak in on us?

Here the question arises, for whom we are giving the description. Of whom do we say, he is able to do any arbitrary multiplications? How does one arrive at this *concept* at all? And for whom, under what circumstances, will this description be important?

Page 115

626. 'Red a degenerate green.' When one sees a leaf turn from green to red, one says that the green is sickly and in the red part is quite degenerate. When one sees the red colour, one always makes a face.

Mightn't red have been explained as the ultimate degeneration of green?

Page 115

627. "One cannot *explain* to anyone what red is!"--How does one arrive at this idea at all; on what occasion does one say this?

Page 115

628. "Colours are something specific. Not to be explained by anything else." How is this instrument used?--Describe the game with colours. The naming of colours, the comparison of colours, the production of colours, the connexion between colour and light and illumination, the connexion of colour with the eye, of notes with the ear, and innumerable other things. Won't what is 'specific' about colours come out in this? How does one shew someone a colour; and how a note?

Page 115

629. When we talk to ourselves in thought: "Something happens; that's for sure." But the usefulness of these words is in reality just as unclear as that of the special psychological propositions that we are trying to explain.

Page Break 116

Page 116

630. Instead of the unanalysable, specific, indefinable: the fact that we act in such-and-such ways, e.g. *punish* certain actions, *establish* the state of affair thus and so, *give* orders, render accounts, describe colours, take an interest in others' feelings. What has to be accepted, the given--it might be said--are facts of living.†1 [Cf. P.I. p. 226d.]

Page 116

631. We judge the motive of an act by what its author tells us, by the report of eyewitnesses, by the preceding

history. That is how we *judge* the motives of a human being. But we do not find it particularly striking that there should be such a thing as the 'judgment of motives'. That this is a quite peculiar language-game--that a table or a stone don't have any motives. That, while there does exist such a question as: "Is that a reliable way of judging a human being's motives?"--still we must already be familiar with what "judgment of motives" means at all. There must already be a technique of which we are thinking' here, in order for us to be able to speak of an alteration of this technique, which we characterize as a more reliable judgment of a motive. [Cf. P.I. p. 224j.]

Page 116

632. One judges the length of a rod, and one can seek and find a method of judging it more exactly, more correctly. So--you say--if *what* we judge here is independent of the method of judging, one can't explain what length is by means of the method of determining length. But anyone who thinks like this is making a mistake. What sort of mistake?--How queer it would be to say: "The height of a Himalayan mountain depends on how one climbs it." "Measuring the height more and more exactly"--one would like to compare this to approaching closer and closer to an object. But it just is not clear in all cases what it means "to approach closer and closer to the length of a rod". And one can't say: "You surely know what the length of a rod is; and you know what 'determining it' means; you therefore know what it means 'to determine the length more and more exactly'".

Under some circumstances it is clear what it means to look for a more exact determination of the length of a rod, and under some circumstances it is not clear and stands in need of a new determination. What "determining the length" means is not learnt by learning what length is and what determining is; rather one learns the meaning of the word "length", among other things, by learning what determining the length is: 'Refining the determination of length' is a

Page Break 117

new technique, which modifies our concept of length. [Cf. P.I. p. 225a.]

Page 117

633. When one describes simple language-games in illustration, let's say, of what we call the 'motive' of an action, then more involved cases keep on being held up before one, in order to shew that our theory doesn't yet correspond to the facts. Whereas more involved cases are just more involved cases. For if what were in question were a theory, it might indeed be said: It's no use looking at these special cases, they offer no explanation of *the* most important cases. On the contrary, the simple language-games play a quite different role. They are poles of a description, not the ground-floor of a theory.

Page 117

634. "How does it come about that it seems to me that this colour-impression that I am having now, is recognized by me as the specific, the unanalysable?"--Ask instead how it comes about that we want to say this. And the answer to *that* is not difficult to find. And isn't it a queer question: why it '*seems*' to us as if... For this very question itself involves a misunderstanding.

Page 117

635. Imagine you were supposed to describe how human beings learn to count (e.g. in the decimal system). You describe what the teacher says and does, and how the pupil behaves in consequence. In what the teacher says and does there occur, e.g., words and gestures that are supposed to encourage the pupil to continue a series; also expressions like "He can count now". Now, ought the description that I give of the process of teaching and learning to contain, besides what the teacher says, my own judgment too, that the pupil can count now, or that the pupil has understood the system of numerals? If I do not put such a judgment into my description--is the description then incomplete? And if I do put it in, am I going beyond mere description?--May I refrain from those judgments and justify myself by saying: "*That is all that happens!*"? [Cf. Z 310.]

Page 117

636. Must I not rather ask: "What does the description do? What purpose does it serve?"--In another context we do indeed know what is a complete and what an incomplete description. Ask yourself: How are these expressions employed: "complete" and "incomplete descriptions"?

Reproducing a speech completely (or incompletely). Does giving the tone of voice, the play of expression, the genuineness or

Page Break 118

ungenuineness of the feeling, the intentions of the speaker, the exertion of speaking--does all this belong to a complete rendering? Whether this or that belongs to the complete description will depend on the purpose of the description, will depend on what the recipient of the description does with it. [Cf. Z 311.]

Page 118

637. The expression "That is all that *happens*" sets a limit to what we call "happening." [Cf. Z 312.]

Page 118

638. My judgment "The pupil can count now" is given for certain purposes. He is thereupon given a job, say. If you say "So this judgment [[sic]] is not part of the description of learning, it is, rather, a prediction"--then I reply "You can take it this way or that". You can say that you are describing the state of the pupil.--

Page 118

639. Imagine red regarded as the summit of all colours. The special role of the triad in our music. Our lack of understanding of the old church modes.

Page 118

640. Under what circumstances would one say, these people conceive all colours as degrees of a *single* property?

Page 118

641. Can you imagine our regarding blue and red as the two outermost poles of deviation from purple? One might then call red a very high, and blue a very low, purple.

Page 118

642. Or imagine a world in which colours almost always occurred in rainbow-like transitions. So that one looks at, say, a green expanse, if it exceptionally does sometimes occur, as a modification of a rainbow.

Page 118

643. Can I say, however, that if *these* were the facts, men would have these concepts? Certainly not. But one can say this: don't think that our concepts are the only possible or reasonable ones: if you imagine quite different facts from those with which we are continually surrounded, then concepts different from ours will appear natural to you. [Cf. P.I. p. 230b.]

Page 118

644. Don't believe that you have the concept of colour within you because, however you look, you look upon a coloured object. (Any more than you have the concept of a negative number because you are in debt.) [Cf. Z 332.]

Page Break 119

Page 119

645. Suppose we were acquainted with a people that had a quite different form of colour attributions from ours: we mostly suppose it an easy thing would then be to teach these people our form of expression. And that, when they are masters of both forms of expression, they will acknowledge the difference between them to be inessential. (The gender of our nouns.†1) Is it so? Must it be so?

Let us imagine that people had two different simple names for two shades of blue, and that colours were *very* different for them, which for us are not so. How would this get manifested? And let us also imagine the reverse: that there is a people for whom red and blue are different only 'in degree', not 'completely different colours'. And what would be the criterion for this?

We say that the same note recurs after every seven notes in the scale. What does it mean to say "We *experience* it as the same"? Is our calling it the same only a linguistic *accident*?

Page 119

646. The feeble-minded are pictured in our imagination as degenerate, essentially incomplete, as it were in rags. Thus as in a state of disorder, rather than more primitive order (which would be a far more fruitful way of looking at them.) [Cf. Z 372.]

Page 119

647. Counting, calculating etc., in a closed system in the way a tune is a closed system. The people count with the aid of the notes of a special tune; at the end of the tune the series of numbers comes to an end.--Am I to say: Of course there are further numbers as well, only these people don't know them? Or am I to say: There is also another way of counting--namely what *we* do--and this these people do not know (do not do).

Page 119

648. The concept of experience: Like that of happening, of process, of state, of something, of fact, of description and of report. Here we think we are standing on the hard bedrock, deeper than any special methods and language-games. But these extremely general terms have an extremely blurred meaning. They relate in practice to innumerable special cases, but that does not make them any *solid*; no, rather it makes them more fluid.

Page 119

649. Calculating in the head is perhaps the one case in which there is a regular use made of imagination in everyday life. That is why it is especially interesting.

Page Break 120

"But I *know* that something went on in me!" And what? Wasn't it, that you calculated in your head?--So after all, calculating in the head is something specific!

Consider first: How does one use the description "He's calculating in his head", "I'm calculating in my head" at all? The difficulty which one comes up against is a vagueness in the criteria for the occurrence of the mental process. Could it be avoided?

650. Can one *imagine* calculating in one's head?

651. One may calculate perceptibly and one may calculate in one's head: could one also do something in one's head, which one can not do perceptibly, for which there is no such thing as a perceptible equivalent?

How would it be if people had a name for calculating in the head, which did not classify it among *activities*, and so *a fortiori* not among those of calculation? They designate it perhaps as a *capacity*. I assume that they use radically different *pictures* from the one we use.

652. But if now someone were to say: "so after all, all that happens is that he *reacts*, behaves, in such-and-such a way,"--then here is a gross misunderstanding. For if someone gave the account: "I in some sense *calculated* the result of the multiplication, without writing etc."--was he talking *nonsense*, or did he make a false report? It is a different employment of language from that of a description of behaviour. But one might indeed ask: Wherein resides the importance of this new employment of language? Wherein resides the importance, e.g. of expression of intention?

653. "How if the pictures that someone had in imagining things had the intensity, clarity, of, e.g. after-images; would these be mental images, or would they be hallucinations--even if he is fully conscious of the unreality of what he sees?" First of all: how do I know that he sees pictures with this clarity? Perhaps he says so. One difference would be this, that his pictures are 'independent' of him. What does that mean? He couldn't use thoughts to dispel them. If, e.g., I imagine the death of my friend, I may tell myself "Don't think about it, think of something else"; but that wouldn't be said to me if I were seeing the event before *[[sic]]* my eyes, e.g. on a film. Then I'd reply to someone who in the assumed case said to me "Don't think about it": "Think about it or not, I'm *seeing* it."

654. Take the use of the English words "this", "that", "these", "those", "will", "shall": it would be difficult to give rules for their

use. But it is possible to *understand* their use, so as to be inclined to say: "If one just has the right feeling for the sense of these words, then one can also apply them." Thus one might ascribe a peculiar meaning even to these words in the English language. Their use gets to be felt as if each had a single physiognomy.

655. Calculating in one's head at the order to do so. Don't let the combination of familiar words prevent you from investigating the language-game right from the bottom.

Remember that one teaches someone to calculate in his head by ordering him to *calculate*! But would it have to be like that? Might it not be that in order to get him to calculate in his head, I mustn't say "Calculate", but rather: "Do something *else*, only get the result" or "Shut your mouth and your eyes and keep still, and you will learn the answer.

I want to say that one need not look at calculating in the head under the aspect of *calculating*, although it has an essential tie-up with calculating.

Nor even under the aspect of 'doing'. For doing is something that one can give someone an *exhibition* of.

656. I want to say: there is no need to interpret reactions different from ours, and hence perhaps favourable to different conceptual structures, as consequences or expressions of (inner) processes which are of a different nature from ours.

There is no need to say: what is in question here are different inner processes.

657. We have, on the one hand his capacity to communicate steps of the calculation without doing any perceptible calculating--on the other, the utterances which he is inclined to make; as for example *this* one: "I did the sum inwardly." The phenomena of the first kind *might* bring us to offer the graphic description: It's as if he calculated somehow and somewhere, and told us steps of this calculation. We may assume what he is inclined to say into our

language as one of its forms of expression; or again we may not. We might, e.g., say to him "You don't calculate 'inside'! You calculate *unreally*." And then *that* is what he says for the future.

Page 121

658. "But I do surely *know* that I *actually* calculate--even if not perceptibly to someone else!" One might take this as a typical expression of someone who was mentally retarded.

Page Break 122

Page 122

659. But if we dispose of the inner process in this way,--is the outer one now all that is left?--the language-game of description of the outer process is *not* all that is left: no, there is also the one whose starting point is the expression. Whatever way our expression may run; whatever the way, e.g., it relates to the 'outward' calculation.

Page 122

660. When a theme, a phrase, suddenly says something to you, you don't have to be able to explain it to yourself. Suddenly *this* gesture too is accessible to you. [Cf. Z 158.]

Page 122

661. Comparison of bodily processes and states, like digestion, breathing etc. with mental ones, like thinking, feeling, wanting, etc. What I want to stress is precisely the incomparability. Rather, I should like to say, the comparable bodily states would be *quickness* of breath, *irregularity* of heart-beat, *soundness* of digestion and the like. And of course all these things could be said to characterize the behaviour of the body.

Page 122

662. Imagine a tribe of people who do not say "he has pains", "we have pains", "the same is going on in him as in me", "these people have the same mental experience" etc.; rather, though there is talk of a mind and of processes in the mind, one says one knows absolutely nothing about whether two people, of whom *we'd* say they were in pain, really have the same or something quite different; and so in this tribe it is said that the people have something unknown; and now there follows in their way of expressing themselves some specification, which comes to the same thing as our "They are having pains". Then these people[[sic]] are likewise not going to say: "When I believe that someone is having pains, I am believing that some particular thing is going on within him" or the like.

But need one look at the matter at all in such a way that the signal of pain and the description of pain-behaviour form a conceptual unit?

I want to ask: "What is the place here of the conceptual and what of the phenomenal?" Must *language* contain an expression of pain? Imagine people with a manual language. Or people who don't speak but only write. Would these have to possess the concept 'pain'?

Page 122

663. But is it easier to imagine people lacking our concept of pain than it is to imagine them not having our concept of a physical body?

Page Break 123

Page 123

664. It is an important fact that we assume it is always possible to teach our language to men who have a different one. That is why we say that their concepts are the same as ours.

Page 123

665. "You start a sentence at whose far end is a verb; you surely aren't going to tell me you began to speak the sentence without an inkling what the verb would be!"--And what does the inkling consist in? And suppose someone really had no inkling of it and yet spoke German fluently! How will one find out whether he had this inkling?

Page 123

666. How far do we investigate the use of words?--Don't we also judge it? Don't we also say that this feature is essential, that one inessential?

Page 123

667. Measuring with a yardstick can be described; how can it be given a foundation?

Is the concept 'pain' an instrument made by man; and what purpose does it serve?

Page 123

668. How can one order someone to mean such and such words like *this*? Apart from ordering him to use them like this.

Page 123

669. Suppose you had to make a decision and the decision was made by pressing one of a number of buttons. The decision that you make in doing this is signaled by a word which is written on the button. It is then, of course, a matter of complete indifference what you experience when you see this word. If the word is, e.g. "fine", you can

mean it as adjective, substantive, or verb, without thereby altering the decision. And equally, when you *pronounce* the word as a decision. At any rate, if someone else is awaiting the decision, it tells him the same thing.

Page 123

670. But how is it when the decision is susceptible of two interpretations, and the one who hears it now gives it *one* of them? He may do this, either through his actions, or, so to speak, in thought. But if the decision did not have to be acted on at once, he might also hear it and for the time being not interpret it *at all*. On the other hand he might give an interpretation in answer to a *question*. This would be a provisional reaction.

Page Break 124

Page 124

671. It is perfectly possible to pronounce words suitably to a particular situation, and hence with such-and-such a meaning, but at the same time to *think* another interpretation. So that for me, unbeknownst to the other, the words have a peculiar meaning.

Page 124

672. If asked, I shall perhaps explain this meaning, without this explanation's having come before my mind earlier. So what had my state of mind, as I spoke the words with the double meaning, to do with the words of the explanation? How far can these words correspond to it? Here there is obviously no such thing as the explanation's fitting the phenomenon.

Page 124

673. One may also mean an expression in one way as one utters it and then at once afterwards, retrospectively, in another.

Page 124

674. It feels to us as if different illustrations attached to the phrase in its two meanings, and as if one can now give an illustration compounded out of the two of them, but then of course it wouldn't be either of the two that accorded with the word or were usual for it.

Naturally, however, that does not mean that whenever one employs the phrase, one of the two illustrations must be present. It only means that *if* we illustrate the word, *one* of the two pictures and not both belong to it.

Page 124

675. 'If you had asked me, *this* is the answer I'd have given you.' That signifies a state; but not an 'accompaniment' of my words.

Page 124

676. Imagine that people had the custom of doodling while they spoke; why should what they produce in this way while talking be less interesting than accompanying processes in their minds, and why should the interest of *these* be of any different kind?

Why does one of these *seem* to give the words their peculiar life?

Page 124

677. According as he meant the word *this* way or *that*, he expressed the one intention or the other. Had the one intention or the other. And one can't say more about the importance of his meaning it than that.

And here again it seems that what went on while he pronounced the individual word ("bank", for example) is of less importance than what went on during, and before, the utterance of the whole

Page Break 125

sentence. As it were, the mood illustrated the whole sentence, not necessarily the single word. And yet, as at the same time we must confess to ourselves, even the illustration does not have to be important. For why should so much depend on it?

And how can it give the sentence a *particular* life, if language doesn't do so? How should it be less ambiguous than the language of words?

Page 125

678. Now this is the decisive point: It is not only from the context that I can judge the meaning; it can be asked about, and in giving the answer one does not derive the meaning from the context.

Page 125

679. Is it just a matter of course that someone who can use language is able to *explain* the words that he understands, the words whose employment he understands? We should, of course, be very much astonished if someone did indeed understand the word "bank", but could give no answer when we asked him "What is a bank?"

Isn't it one thing to understand the sentence "Let's walk in the sun for a while" -and another to know how to explain the word "sun"?--But mustn't one who understands this sentence know, e.g. what the sun looks like? As one who understands the sentence "I haven't any pain" must, e.g., know how one can give oneself pain and how

someone in pain behaves etc.--

Page 125

680. Further; if it is possible for the ambiguous word by frequent repetition to take on *each* 'meaning', why shouldn't some men who pronounce it without any context ordinarily do so without any feeling of a meaning? Or why shouldn't men pronounce a word in this way with a kind of fluctuating meaning, where no context fixes it?

Page 125

681. "But what do you do when you obey the order 'Say... and mean... by it?'"--You don't do *something else*. But neither do you do anything specific.

Page 125

682. In any case this isn't a language-game that is very early learnt: pronouncing a word by itself in such and such a meaning. The foundation is obviously that someone says he can pronounce the word... and mean one or the other of its meanings as he does so. That's quite easy when the word has two meanings; but can you also say the word "apple" and mean "table" by it?--Still, I might use a secret language, in which it has this meaning.

Page Break 126

Page 126

683. "Give him this order, and mean... by it." "Tell him this and mean... by it." That would be a remarkable order, which is not ordinarily given. Or I say to someone: "Deliver this message"--and ask him afterwards: "Did you also mean it in such and such a way?"

Page 126

684. But is the past tense form then justified? Yes; for I make a contrast between changing one's mind and its staying the same. I really want to know not merely what he means now, but also what he did mean.--One might perhaps ask: "What *do* you mean? and have you changed your mind?" When the answer to this question is No, then what he says now he also meant before.

I want to say: the criteria for the past happening here are different from what they are for the emergence of a picture.

Page 126

685. Then how am I to describe this psychological phenomenon? Am I to say: one can mean a word in such and such a way upon request? that one fancies one means it this way or that? Am I to say that the word "mean" is being used here in a different sense; that one ought properly to have used a different word? Am I to propose such a word?--Or is just this the phenomenon, that we use the word "mean" here, which we learnt for another purpose?

Page 126

686. Is it a very primitive language-game, in which one says: "At this word.... occurred to me?" [Cf. P.I. p. 218b.]

Page 126

687. Instead of "I mean *this* by the word" one might also say "The word stood for...". And then how can the word have stood for this thing--and not for that, when I pronounced it? And yet *that's* just what it looks like.

So is this as it were an optical illusion? (Such as to make the word seem to *mirror* the object that is correlated with it by the explanation.) And if it is an optical illusion, what do people lose who are unacquainted with this illusion? They can't be losing very much.

Page 126

688. The peculiar experience of meaning is characteristic because we react with an explanation and use the past tense: just as if we were explaining the meaning of a word for practical purposes. [Cf. Z 178.]

Page 126

689. The intention may have altered, and simultaneously with it an experience-content, but the intention was not an experience.

Page Break 127

Page 127

690. One of the principles of observation would surely have to be that I do not *disturb* the phenomenon that I observe by my observation of it. That is to say, my observation must be usable, must be applicable to the cases in which there is no observation.

Page 127

691. So isn't there any peculiar experience corresponding to the jump of: "Now I know!'"? No--Imagine one who is always going off with "Now I've got it!" when he hasn't got hold of anything;--what are we to say about him? What experience did he have? It is not the peculiar content of experience at the jump that gives it its peculiar interest, and when someone says that he understood everything in that moment, this is not the description of an experience-content.--But why not?--I want to make a distinction between a statement like "At that moment I saw the

formula clear before me", and one like "At that moment I grasped the method". But not as if I wanted to say--"because one can't grasp a method in a moment". One can, it happens very often.--I want to say: "Now I understand!" is a *signal*, not a description." And *what* is effected by my saying that? Well, it directs attention to the origin of such a signal; there comes into the foreground the question "How does someone learn the words 'Now I understand it!', and how, e.g., the description of a mental image?" For the word "signal" points towards a proceeding that is being signalled. [Cf. P.I. p. 218f.]

Page 127

692. It is of course the indisputability that favours the picture of something's being described here, something that we see and the other does not, and that is near to us and always accessible, but for the other is hidden: hence something that exists *within us* and which we become aware of by looking into ourselves. And psychology is now the theory of this inner thing.

Page 127

693. So if I want to say that our 'utterances', with which psychology has to do, absolutely are not all descriptions of experience-contents, I must say that what are called descriptions of experience-contents are only a small group of these 'indisputable' utterances. But what grammatical features mark off this group?

Page 127

694. An experience-content is what can be produced in a picture, a picture in its subjective meaning, when its purport is: "This I see whatever the object may be that produces the impression." For the experience-content is the private *object*.--But how then can pain form

Page Break 128

such a content?--The sensation of temperature does so rather. And hearing is still closer akin to sight;--but also quite different.

Page 128

695. It positively seems to us as if pain had a body, as if it were a thing, a body with shape and colour. Why? Has it the shape of the part of the body that hurts? One would like, e.g., to say "I could *describe* the pain, if only I had the requisite words and elementary concepts". One feels: all that is lacking is the necessary nomenclature (James.) As if one could even paint the sensation, if only others would understand this language.--And one really can give a spatial and temporal description of pain. [Cf. Z 482.]

Page 128

696. If the expression of pain were only a cry and its strength depended only on the available breath, but not on the damage--should we in that case be inclined to regard pain as something observed?

Page 128

697. Why do you think that someone *else's* pain is similar to his visual sensation?--Or put it like this: why do we group sight, hearing and the sensation of touch together? Because we 'get acquainted with the outer world' through them? Pain certainly could be regarded as a kind of tactile sensation.

Page 128

698. But how about my idea that we don't actually judge the position and movement of our limbs by the feelings that these movements give us? And why should we judge the qualities of the surfaces of bodies in this way, if that cannot be said of our movements?--What is our criterion at all, for saying that our *feeling* tells us this?

Page 128

699. How does one judge whether fatigue (e.g.) is an indefinitely located bodily feeling?

Page 128

700. One would like to say that "I believe" can't *properly* be the present of "I believed". Or: one ought to be able to use a verb in such a way that its past has the sense of "I believed", while its present has a sense different from that of our "I believe". Or again: There ought to be a verb, whose third person in the present tense has the sense "he believes", but whose first person has a sense different from that of "I believe".

But then ought there also to be a verb, whose first person says "I believe", but whose third person does not say what we mean by "he believes"? So the third person would also have to be indisputable?

Page Break 129

Page 129

701. What if someone were to say: "I *know* it won't rain, but I *believe* it will rain."

Page 129

702. What is common to sense-experiences?--The answer that they acquaint us with the outer world is partly wrong and partly right. It is right inasmuch as it is supposed to point to a *logical* criterion. [Cf. Z 477.]

Page 129

703. Could an "I was lying" be imagined, which I inferred from observation of my own behaviour? Only in case someone else cannot make the *confession* "I was lying" either.

Does "I was lying" describe an experience; or again "I made this statement in good faith"?--You need to think of the fact that I don't only infer his good faith from such-and-such behaviour, but I also take his word for it, which he does *not* base on self-observation.

Page 129

704. How is it that I cannot gather that I believe its going to rain from my own statement "It's going to rain"? Can I then draw no interesting conclusions from the fact that I said this? If someone else says it, I conclude perhaps that he will take an umbrella with him. Why not in my own case?

Page 129

Of course there is here the temptation to say: In my own case I don't *need* to draw this conclusion from my words, because I can draw it from my mental state, from my belief itself.

Page 129

705. Why do I never conclude from my words to my probable actions? For the same reason as I don't conclude from my facial expression to my probable behaviour,--for the interesting thing isn't that I don't conclude from my expression of emotion to my emotion, but rather than I don't conclude from that expression to my later behaviour either, as others do, who observe me. [Cf. Z 576.]

Page 129

706. If you philosophize, you often make the wrong, inappropriate, gesture in connexion with a verbal expression. [Cf. Z 450.]

Page 129

707. If someone meets me in the street and asks "Where are you going?" and I reply "I don't know", he supposes that I have no definite *intention*; not, that I don't know whether I shall be able to carry out my intention. (Hebel. †1) [Cf. Z 582.]

Page Break 130

Page 130

708. My super-ego might say of my ego: "It is raining, and the ego believes so," and might go on "So I shall probably take an umbrella with me." And now how does this game go on?

Page 130

709. Consider also the statement: "I shall probably..."--where what follows is a voluntary action, not an involuntary one.

Page 130

710. One says, e.g., "One *feels* conviction, one doesn't infer it from one's own words or tone of voice."

Page 130

But what does it mean to say one *feels* conviction? What is *true* is: one does not make an inference from one's own words to one's own conviction; nor yet to the actions arising from the conviction. [Cf. P.I. p. 191g.]

Page 130

711. At the question "Why don't I infer my probable actions from my talk?" one might say that it is like this: as an official in a ministry I don't infer the ministry's probable decisions from the official *utterances*, since of course I am acquainted with the source, the genesis of these utterances and of the decisions.--This case would be comparable to one in which I carry on conversations with myself, perhaps even in writing, which lead me to my utterances out loud in conversation with other people; and now I say: I shall surely infer my future behaviour, not from these utterances, but from the far more reliable documents of my inner life.

Page 130

712. After all I know that when I am angry, I simply don't need to learn this from my behaviour.--But do I draw a conclusion from my anger to my probable action? One might also put the matter, I think, like this: my relation to my *actions* is not one of observation.

Page 130

713. When I tell someone: "I know that you will do this" then the best means of making this prediction true is to persuade the other into the action.

Page 130

714. If I tell someone "Now you will raise your hand", this prediction may be reason enough for its non-fulfilment; unless it is an order which the other respects.

Page 130

715. "It is raining and I believe it is raining." Turning to the weather, I say that it is raining; then, turning to myself, I

say that I believe it.--

Page Break 131

But what do I do when I turn to myself, what do I observe? Suppose I say: "It's raining, and I believe it will soon stop"--do I turn to myself at the second part of the statement?--Indeed, if I want to find out whether *he* believes that, then I must turn to him, I must observe him. And if I wanted to find out what I believe by observation, I should have to observe my *actions*, just as in the other case I have to observe his.

Now why don't I observe them? Don't they interest me? Apparently they do *not*. I hardly ever ask someone else who has been observing me, whether he has the impression that I believe such and such: that is, in order in this way to make inferences to my future actions. Now why should a really good observer not be able to predict my behaviour from what I say and do better than I would be able to? But perhaps I shall then act as he foresees, only if he makes no prediction of it to me.

Page 131

716. When I say "I remember, I believed...", don't ask yourself "What fact, what process is he remembering?" (that has already been stipulated)--ask rather: "What is the purpose of this language, how is it being used?"

Page 131

717. The sense of sight, of hearing, of touch may fail, so that I am blind, deaf, etc.; but what would correspond to that in the domain of intention?

And how would a man behave without imagination? Or one who is incapable of being sad or cheerful?

Page 131

718. "Hope is directed to the future"--but is there a feeling, identical with hope, but directed to the present or to the past? The same mental movement, so to speak, but with a different object? Ask yourself: what should here be regarded as the criterion of identity of the mental movements? Connected with this: "Is the jump of 'Now I know!' a peculiar, specific jump?"

Page 131

719. Even if I were to admit that I know more of my own belief than of anyone else's I would then surely have to say that what I can know about myself is what I know of someone else though there's much more of it.--So, even if it would be redundant, I'd have to be able to apply a verb to myself, in the way I can apply the word "believe" to other people. What prevents me?

Page Break 132

Page 132

720. The concept of the world of consciousness. We people a space with impressions.

Page 132

721. "The ideal clock would always point to the time 'now'." This also connects up with the language which describes only my impressions of the present moment. Akin is the primal utterance that is only an inarticulate sound. (Driesch.) The ideal name, which the word "this" is.

Page 132

722. I should like to speak of a genealogical tree of psychological concepts. (Is there here a similarity to a genealogical tree of different number concepts?)

Page 132

723. The difficulty of renouncing all theory: One has to regard what appears so obviously incomplete, as something complete.

Page 132

724. Anxiety borrows the pictures of fear. "I have the feeling of impending doom."†1

Page 132

725. But what is the content, the content of consciousness, in anxiety? The question is wrongly framed.

Page 132

726. "A picture (mental image, memory image) of longing." One thinks that one has already done everything by speaking of a 'picture'; for longing just is a content of consciousness, and its picture is something that is (very) like it, even if it is less clear than the original.

And indeed one might very well say of someone who plays longing on the stage of a theatre, that he experiences, [[sic]] or has, a picture of longing: for this is not given as an *explanation* of his proceedings, but as part of a description. [Cf. Z 655.]

Page 132

727. But wouldn't I say that the actor does experience something like real longing? For isn't there something in what James says: that the emotion consists in the bodily feelings, and hence can be at least partially reproduced by

voluntary movements?

Page 132

728. Is it so disagreeable, so sad, to draw down the corners of one's mouth, and so pleasant to pull them up? What is it that is so frightful about fear? The trembling, the quick breathing, the feeling in the facial muscles?--When you say: "This fear, this uncertainty, is frightful!"--might you go on "If only I didn't have this feeling in my stomach!"?

Page Break 133

Page 133

729. The expression "This anxiety is frightful!" is like a groan, a cry. Asked "Why do you cry out?", however--we wouldn't point to the stomach or the chest etc. as in the case of pain; rather, perhaps, at what gives us our fear.

Page 133

730. When anxiety is frightful, and when in anxiety I am conscious of my breathing and of a tension in the muscles of my face--does that mean that I find *these feelings* frightful? Might they not even signify an alleviation? [Cf. Z 499.]

Page 133

731. Compare fear and anxiety with care.

Page 133

732. And what sort of description is *this*: "Ewiges Düstere steigt herunter"†1....

Page 133

One might describe a pain like that; even paint it.

Page 133

733. Isn't the 'content' what one peoples the space of impressions with? What changes, what goes on, in space and time. If, e.g., one talks to oneself, then it would be the imagined sounds (and perhaps the feeling in the larynx or something like that).

Page 133

734. Is lying a particular experience? Well, can I say to someone "Now I am going to lie to you", and then do it? [Cf. Z 189.]

Page 133

735. To what extent am I conscious of lying while I lie? Only inasmuch as I don't first realize it later, but all the same I do know later that I lied. Consciousness of lying is a *capacity*. It is no contradiction of this that there are characteristic feelings of lying [Cf. Z 190.]

Page 133

736. For knowledge is not *translated* into words when it is expressed. The words are not a translation of something else that was there before. [Cf. Z 191.]

Page 133

737. One says "I notice in his tone of voice that he does not believe what he says". Or I suppose it, because he has generally shewn himself unreliable. How can I apply this to *myself*? Can I, e.g., infer from my tone of voice, that I probably shan't act in a way that fits my words? (And yet someone else does make that inference.) Or can I infer it from my previous unreliability? Certainly for preference the latter. But I don't judge the tone of my voice at all as I do that of

Page Break 134

someone else. Mind you, if I could see myself later, say in a talking film, I should perhaps say: "I don't quite trust myself."

Page 134

738. But before all else: I seem to have a substitute for all such conjectures, one that is more certain than they are. After all I *know* that I don't believe what I am saying, and that surely gives me the best of reasons--I should like to say--for assuming that I shall not act accordingly. The point is, I have an *intention* concerning my actions.

Page 134

739. "But I know that I am lying! What need have I to draw conclusions from my tone of voice, etc.?"--But that's not how it is. For the question is: Can I draw the same conclusions e.g. about the future, from that 'knowledge'; can I make the same *application* of it, as of observed signs?

Page 134

740. And then, is the intention always *quite* clear? I say, e.g., "It will happen all right", *half*, because I believe it, *half* because I want to comfort the others.

Page 134

741. *Arrières pensées*. "Mine I know, *conjecture* his". But what *interest*, what importance, have his *arrières pensées* got for me? (Now, weigh the question.) And now the 'knowledge' of my own *arrières pensées* really does play the same part for me, as the conjecture of his does for him.

Page 134

742. 'To judge others by oneself.' Of course there is such a thing. And I sometimes even infer that someone else is in pain because he behaves as I do in this case.

Page 134

743. It might be said: If I tell you my *arrières pensées*, then I communicate to you just what you conjecture when you conjecture these *arrières pensées*. That is: if you conjecture the *arrières pensées* as, so to speak, an active principle, and I give expression to them, you can use my expression immediately in describing that agent. My expression explains exactly what he wants to explain.

Page 134

744. "What should I draw conclusions from my own words to my behaviour for, when in any case I know what I believe?" And what is the manifestation of my knowing what I believe? Is it not manifested precisely in this, that I do not infer my behaviour from my words? That is the fact.

Page Break 135

Page 135

745. Why do I not infer from my tone of voice that I am not really convinced of what I am saying? or the whole of what gets inferred from it?--And if it is answered "Because I know my own *conviction*"--the question is "How does that come out?" Am I now to say: "In the fact that I have no doubt what it is?"

Page 135

746. The *knowledge* of metre. One who *knows* the metre, hears it differently.

Page 135

747. Thoughts can be care-laden, but not toothache-laden.

Page 135

748. I am now whistling a note, but I am also--now--whistling a tune.

Page 135

749. We do not say "I look furious; I only hope I shall commit no violence". But the question is not "How is it that we don't?"

Page 135

750. The psychology of judgment: For judgment too has its psychology.

It is important that one can imagine every judgment beginning with the word "I". "I judge that...."

So is each judgment a judgment about the one who is judging? No, it is not, inasmuch as I don't want the main consequences that are drawn to be ones about *myself*, I want them rather to be about the subject matter of the judgment. If I say "It's raining," I don't in general want to be answered: "So *that's* how it seems to you." "We're talking about the weather," I might say, "not about me."

Page 135

751. "But why is the use of the verb 'believe,' why is its grammar, put together in such a queer way?"

Well, it isn't *queerly* put together. It's only queer if one compares it with, say, the verb "eat".

Page 135

752. "Now what's he likely to do next," I say as I watch him. Do I watch myself and say "what am I likely to do next"?

Page 135

753. Suppose I were moving about a room, and had a screen before my eyes on which I could see myself as an observer would see me. As I move about the room I watch the screen continuously and observe my action.--What would be the difference between these two cases: (a) I shall be influenced by what I see on the screen as I am by my

Page Break 136

normal seeing of my surroundings--(b) I move *involuntarily* and observe myself like a stranger.

But don't I feel my movements?--But isn't this feeling something that *happens* to me, like any other sense-impression?

Page 136

754. Very well: the kindesthetic[[sic]] feeling is a *different*, a peculiar feeling.--But so is smell, so is hearing, etc.--Why does that make such a difference?

The "feeling of innervation"--this expresses what one would like to say: that it is like an *impulse*. A feeling

like an impulse, though? What is an impulse, then? A physical picture. The picture of a push.

Page 136

755. What is the difference between these two things: following a line involuntarily--following a line on purpose?
What is the difference between these two things: tracing a line with care and great attention--and attentively watching how my hand follows a line? [Cf. Z 583.]

Page 136

756. Some differences are easy to give. One resides in foresight of what the hand will do. [Cf. Z 584.]

Page 136

757. Is "I am doing my utmost" the expression of an experience? One difference: One says "Do your utmost". [Cf. Z 581.]

Page 136

758. Does one say: "Give yourself this muscular sensation"? And why not?--"This"?--Which one?--But can't I give myself a particular muscular sensation by moving my arm?--Try it. Move your arm--and ask yourself what feeling you have produced in yourself.

If someone were to tell me: "Bend your arm and produce the characteristic sensation," and I bent my arm, then I'd have to ask him: "Which sensation did you mean? A slight tension in the biceps, or a feeling in the skin on the inside of the elbow joint?" Indeed, if someone ordered me to make a movement I might make it and then describe the sensations that it produces, together with their peculiar place (which would hardly ever be the joint). And I would often have to say that I felt *nothing*. Only one mustn't confound this with the statement that it was as if *there were no sensation* in my arm.

Page 136

759. Are you reading this page voluntarily? And what does the act consist in?--One may read upon request and also stop reading. One may also imagine something on request. E.g. one may recite a poem to

Page Break 137

oneself in the imagination, or do a sum. In this imagining, do you *feel* whether you are imagining something voluntarily or involuntarily?

You can obey an order to summon up thoughts, to call up images--but also, and this is something else, you can obey an order to think of something.

Page 137

760. Images, one might say, are voluntary, after-images involuntary.

Page 137

761. An involuntary movement is, *for example*, one that one can't prevent; or one that one doesn't know of; or one that happens when one purposely relaxes one's muscles in order not to influence the movement.

Page 137

762. When, e.g., I see someone eating, do I ask myself whether he is doing it voluntarily or involuntarily? Perhaps it is said that I assume it is happening voluntarily. What do I assume; that he feels it? And feels it in a particular way?

Page 137

763. How do I know whether the child eats, drinks, walks, etc. voluntarily or involuntarily? Do I ask the child what it feels? No; eating, as anyone does eat, is voluntary.

Page 137

764. If someone were to tell us that with *him* eating was involuntary--what evidence would make one believe this? [Cf. Z 578.]

Page 137

765. When I raise my hand suddenly to shield my eye--is the movement voluntary?--and do I *feel* it differently from a voluntary movement?

Page 137

766. The concept of 'effort'. Do you feel the effort? Of course you feel it. But don't you also *make* it?--What are the signs of effort? With a great effort, I lift a heavy weight. My muscles are tense, my face screwed up, my breath short--but do I do all that; doesn't it merely happen to me? How would it be, if it merely happened to me? How would that case differ from that of willing? Would I talk somehow differently? Would I say: "I don't know what's happening to me: my muscles are tense, my face... etc. etc.?" And if I were to say: "Well, relax your muscles," he would reply "I can't".

But suppose someone were to say to me: "I feel that I *have* to do *whatever* I do," and that at the same time he behaved just like anyone else?

Page Break 138

Page 138

767. Isn't saying that kinaesthetic sensation shews me what movement is made analogous to the opinion that some characteristic of pain shews me its place?

Page 138

768. If someone wanted to represent pain by means of a colour-picture--would he put a local sign into the picture? And why not?

Page 138

769. Is the sensation not the measure of the effort? That is to say, when I say "Now I'm pulling harder", do I notice this by noting the degree of the sensation? And what is there to say against that? One tells someone "Exert yourself more!"--not, so that he shall feel more, but so that he shall achieve more.

Page 138

770. Why does one feel as if one could describe, or paint, a tactile sensation (its content) but not a sensation of motion or position?

Page 138

771. Can you say, e.g., that your sensation of position is weak or strong?

And your sensations when you move a limb may indeed be stronger or weaker (or absent), but that isn't a perception of movement.

Page 138

772. Sensations of movement--these are sensations that are called into being by movement--they may, for example, be pains.

How does one know that it isn't these sensations of movement that tell us what movements we are making? What would be a sign of its being so?

Page 138

773. Isn't it an important fact that the theatre gives us exhibitions of colour and sound, but not of sensations of touch? The use of smells and of sensations of temperature could be imagined, but not of sensations of touch.

Page 138

774. Someone, who is threading a needle with all the appearance of taking care, and tells us that he does it *involuntarily*. How could he justify this statement?

Page 138

775. What one can know, one can be convinced of--and can also conjecture. (Grammatical remark.)

Page 138

776. Voluntary movements are certain movements with their normal *surroundings* of intention, learning, trying, acting. Movements, of

Page Break 139

which it makes sense to say that they are sometimes voluntary, sometimes involuntary, are movements in a special surrounding. [Cf. Z 577.]

Page 139

777. One category of psychological phenomena (facts) would be 'seeds'. But this word may just as easily be the expression of a misunderstanding, like the phrase "experience of tendency" (James). The phrase "move in a board-game", too, does not characterize a *kind of movement*.

Page 139

778. Translating from one language into another is a mathematical task and the translation of a lyrical poem (for example) into a foreign language is quite analogous to a mathematical *problem*. For it is certainly possible to formulate the problem "How is this joke (e.g.) to be translated by a joke in the other language?"--i.e. how is it to be replaced; and the problem may also be solved; but there wasn't a method, a system, belonging to the solution of it. [Cf. Z 698.]

Page 139

779. You know that you are lying; if you are lying, you know it. An inner voice, a feeling, tells me? Might this feeling not deceive me?

Does a voice always tell me? And when does it speak? The whole time?--And how do I know I can trust it?

Page 139

780. A lie has a peculiar surrounding. There is in the first place a motive there. Something occasions it.

Page 139

781. The consciousness of lying is of the category of the consciousness of intention.

Page 139

782. Do not forget: sight, smell, taste etc. are sensations only because these concepts have *something* in

common--as one might take auger, chisel, axe, oxyacetylene torch together, because they have certain functions in common.

Page 139

783. "A pain, a sound, a taste, a smell, has a particular colour." What does that mean? (Quality. Adjective.)

A colour may be *greenish*, or *blueish*--there is such a thing as a blending of colours; and in the same way too a blending of smells, sounds, tastes; qualitative gradations. How does one distinguish qualitative from quantitative gradations, I mean from gradations of 'intensity'?

Still bearable--no longer bearable, these, for example, are degrees of intensity. Suppose someone were to ask: "How can I know that

Page Break 140

what I sense as different degrees of loudness, for example, is not sensed by someone else as different qualities, comparable to different hues?"--Compare the reaction to an alteration in strength with that to an alteration of quality.

Page 140

784. I feel my arm and, oddly, I should like to say: I feel it in a particular position in space: as if, that is, my bodily feeling were distributed in a space in the shape of an arm, so that in order to represent the matter, I would have to represent the arm, say in plaster, in the right position. [Cf. Z 480.]

Page 140

785. Imagine that the point of a pencil were brought into contact with my skin at a certain place; I can say I feel where it is: But do I feel *where* I feel it? "How do you know that the point is now touching your thigh?"--"I feel it." By feeling the contact I know its place; but ought I therefore to speak of a feeling of place? And if there is no such thing as a feeling of place, why must there be a feeling of position?

Page 140

786. It is odd. My lower arm is now lying horizontally and I should like to say I feel that; but not as if I had a feeling that always goes with this position (as one would feel ischaemia or congestion)--rather as if the 'bodily feeling' of the arm were arranged or distributed horizontally, as, e.g., a film of damp or of fine dust on the surface of my arm is distributed like that in space. So it isn't really as if I felt the position of my arm, but rather as if I felt my *arm*, and the feeling had such and such a *position*. But that only means: I simply *know* how it is lying--without knowing it *because....* As I also know where I feel pain--but don't know it *because....* [Cf. Z 481.]

Page 140

787. Consider:--"It isn't true that what I believe is always false. For example, it's raining now, and I believe it."

One might say of him: He speaks like *two* people.

Page 140

788. Why do I have doubts about his intention, but not about mine? To what extent am I indubitably acquainted with my intention? What, so to speak, is the *use* of my *knowing* my intention? That is, what is the use, the function, of the expression of intention? That is, when is something an expression of intention? Well, when the act follows it, when it is a prediction. I make the prediction, the same one as someone else makes from observation of my behaviour, *without* this observation.

Page Break 141

Page 141

789. When dealing with a 'feeling of unreality', we are inclined to say: "All I know is that under certain circumstances human beings often say that they felt everything around them was 'unreal'. Naturally we also know what use of this word the people had learnt, and besides that something about their other utterances. More we do not know."--Why don't we talk in the same way when what is in question is utterances expressive of pleasure, of conviction, of the voluntariness and involuntariness of movements?

Page 141

790. What should I reply to someone who tells me that *he* feels the position and motions of his limbs, that a *feeling* tells *him* their posture and movement? Am I to say he is lying, or that he is making a mistake, or am I to believe him? I should like to ask him *how* a feeling tells him of, for instance, this posture. Or better: how he *knows* that a *feeling* tells him this.

Page 141

791. (One says something *ordinary*,--with the wrong gesture.) [Cf. Z 451.]

Page 141

792. Remember again here the feeling which occurs without justification and to all appearances without any ground, that a particular district must lie in *that* direction. If this feeling weren't for the most part deceptive, one would speak here of a kind of *knowing* by feeling. And the sources of this feeling can only be conjectured, or established by

experience.

Page 141

793. The most important thing here is this: there is a difference; one notices the difference, 'which is a difference of category'--without being able to say what it consists in. That is the case in which one usually says one knows the difference by introspection. [Cf. Z 86.]

Page 141

794. And it sounds too much like an appeal to introspection, if I wanted to say "Test yourself, now--see whether you really determine the position of your limbs by feelings in them."--And it would even be wrong, for then the question is: If someone did that, how would it come out that he did? For suppose after self-examination he were to assure me that it was so, or that it was not so,--how do I know whether I have the right to trust him; I mean, whether he has even understood me right? Or again: how do I test whether I understand him?

Page Break 142

Page 142

795. Someone tells me: "I don't know how I move my fingers, but I know when I am spreading them out by the feeling in the skin between the fingers." Here one would have to ask: Then can't you carry out the order: "Spread out your fingers" straight off with your eyes shut?

Page 142

796. We feel our movements. Yes, we really *feel* them; the sensation is not like a sensation of taste or of temperature, it is, rather, like a sensation of touch: the sensation when skin and muscles are squeezed, pulled, displaced. [Cf. Z 479.]

Page 142

797. How can I use the guidance of my feeling of movement when I make movements? For, how, before the movement has begun, can I select from all the muscles the ones that are going to give me the right feeling of movement? If there is a problem: "How do I know, when I don't see the movement, that, and to what extent, it has taken place?"--why then is there no problem: "How do I know at all how to accomplish, say, a movement I've been ordered to make"? (Russell once made a wrong observation about this.)

Page 142

798. I may, e.g., say that I now know that my finger is bent, but that I have no feeling of any kind in it; at any rate none that I associate peculiarly with this position. Thus if I were to be asked: "Do you feel something, of which you want to say that you wouldn't feel it in the straightened-out position; or is there some feeling missing, which would be present in the other position?"--I should have to answer No.

Page 142

799. "Is pleasure a sensation?" (I. A. Richards.) That means something like: Is pleasure something like a note or a smell?--But is a note then something like a smell? To what extent?

Page 142

800. Someone who asks whether pleasure is a sensation probably does not distinguish between ground and cause, for otherwise it would occur to him that one has pleasure *in something*, which does not mean that this something causes a sensation in us. [Cf. Z 507.]

Page 142

801. But pleasure does at any rate go with a facial expression, and, though we don't see this on ourselves, still we do feel it.

And just try to reflect on something very sad with an expression of radiant joy. [Cf. Z 508.]

Page Break 143

Page 143

802. It is of course possible that the glands of a sad man secrete differently from those of a cheerful one; also, that this secretion is the, or a, cause of sadness. But does it follow from this that sadness is a *sensation* brought about by this secretion? [Cf. Z 509.]

Page 143

803. But here the thought is: "You surely *feel* the sadness--so you must feel it *somewhere*; otherwise it would be a chimera. But if that is what you want to think, just recall the difference between sight and pain. I feel pain in my hand--and colour in my eye? As we here want to employ a schema instead of simply noting what is really common, we make a wrongly simplified picture of our conceptual world. It is as if we were to say that all the plants in the garden had flowers, all had petals--fruits--seeds. [Cf. Z 510.]

Page 143

804. A smell may be extremely pleasant. Is what is pleasant about it only a sensation? In that case the sensation of

pleasantness would accompany the smell. But how would it *relate to the smell*? Of course, the expression of the pleasantness is similar in *kind* to the expression of a sensation, in particular to that of pain. But joy has no place; there are joyful thoughts, but not toothache-ish ones.

But--one would like to say--whether joy is a sensation, or *what* it is, is something one has to notice when one has it!--(And why especially when one has it, and not when one doesn't have it?) Do you also notice the *nature* of one, when you are eating *one* apple, and the *nature* of zero when you are eating none?

Page 143

805. Voluntariness hangs together with intentionalness. And therefore with decision as well. One does not decide on an attack of angina and then have it.

Page 143

806. One brings on a sneeze in oneself or a fit of coughing, but not a voluntary movement. And the will does not bring on sneezing, nor yet walking. [Cf. Z 579.]

Page 143

807. Sensation--that is what one takes to be immediately given and concrete, what one only needs to look at in order to know it; it is that which is really there. (The thing, not its emissary.)

Page 143

808. "I know whether I am talking in accordance with my conviction or contrary to it." So the conviction is what is important. In the background of my utterances. What a *strong* picture. One might paint conviction and speech ("from the depths of his heart"). And yet how little that picture shews!

Page Break 144

Page 144

809. "The smell is marvellous!" Is there any doubt that it is the smell that is marvellous?

So is it a property of the smell?--Why not? It is a property of ten to be divisible by two, and also to be the number of my fingers.

But there might be a language in which people merely shut their eyes and said "Ah, this smell", [[sic '?]] and there is no subject-predicate sentence that is equivalent to the exclamation. That just is a 'specific' reaction. [Cf. Z 551.]

Page 144

810. Is that of which he says he has it, and of which I say I have it, without our inferring this from any observation--is it the same as what we derive from observation of someone else and from the *expression* of his conviction? [Cf. Z 574.]

Page 144

811. Can one say: I *infer* that he will behave as he *intends* to behave? [Cf. Z 575.]

Page 144

812. I make inferences to the consequences of his conviction from the expression of his conviction; but not to the consequences of my conviction from the expression of it.

Page 144

813. Imagine an observer who, as it were automatically, says what he is observing. Of course he hears himself talk, but, so to speak, he takes no notice of that. He sees that the enemy is approaching and reports it, describes it, but like a machine. What would that be like? Well, he does not act according to his observation. Of him, one might say that he speaks what he sees, but that he does not *believe* it. It does not, so to speak, get inside him.

Page 144

814. Why don't I make inferences from my own words to a condition from which words and actions take their rise? In the first place, I do not make inferences from my words to my probable actions.

Page 144

815. Asked: "Are you going to do such-and-such?" I consider *grounds for* and *against*.

Page 144

816. But consider this: After all I sometimes take someone else's word,--so I would surely at least sometimes have to take my own word too, that I have such and such a conviction. But when I report my observation in a quasi-automatic fashion, then this report has nothing at all to do with my conviction. On the other hand I might

Page Break 145

have confidence in myself, or in my observing self, just as another person does. So I might say "I say 'It's raining', so it will presumably be true" Or: "The observer in me says 'Its[[sic]] raining', and I am inclined to believe him."--For isn't this--or something like this--how it is, when a man says that God has spoken to him or through his mouth?

Page 145

817. The *important* insight is that there is a language-game in which I produce information *automatically*, information which can be treated by other people quite as they treat non-automatic information--only here there will be no question of any 'lying'--information which I myself may receive like that of a third person. The 'automatic' statement, report etc. might also be called an 'oracle'.--But of course that means that the oracle must not avail itself of the words "I believe...".

Page 145

818. Where is it said in logic that an assertion cannot be made in a trance?

Page 145

819. "If I look outside, I see that it's raining; if I look within myself, I see that I believe it." And what is one supposed to do with this information?

Page 145

820. "Suppose that it's raining and I don't believe it"--when I assert what is supposed in this supposition,--then, so to speak, my personality splits in two.

"Then my personality splits in two" means: Then I no longer play the ordinary language-game, but some different one.

Page 145

821. "The words 'It's raining' are written in his soul"--this is to mean as much as (i.e. to be replaceable by) "He believes that it is raining". "The words 'It's raining' are written in my soul"--means, say, "I can't get rid of the belief that...", "The idea that... has taken possession of me."

For consider this fact: the words "I believe it is raining" and "It'll be raining" may say *the same: inasmuch*, that is, as in some contexts it makes no difference which of the two sentences we use. (And rid yourself of the idea that one of them is accompanied by a different mental process from the other.) The two sentences may say the same thing, although there is an "I believe..." and "He believes..." etc. that corresponds to the first and not to the second. For a different *concept* is used in the construction of the first. That is: in order to say that perhaps it is raining we do *not* need the concept 'believe', although we may use it for that purpose. The concept of a

Page Break 146

proposition's being 'written on the soul' is now a third concept, which partly coincides with the others in its application, and partly not.

I want to say that in order to construct the assertion "It'll..." there is no need of the 'queer' concept 'believe', although it *may* be used for that purpose.

Page 146

822. Think also of this: 'It'll be raining and it is raining' doesn't mean anything, and no more does "It'll be raining and it isn't". By contrast one can say 'It seems to be raining and it is raining' and also 'It seems to be raining... and it isn't raining'. And 'It seems to be raining' may have the same sense as 'It'll be raining'.

Page 146

823. How do I know that I am in the state of believing:...? Do I look into *myself*? Is it even *any* use to observe myself? Well, I might perhaps ask myself "How much would I bet in this case?"

Page 146

824. Pretence. Simulating pain. It doesn't consist merely in giving expressions of pain when one has no pain. There must be a motive present for the simulation, hence a situation which is not quite simple to describe. Making oneself out sick and weak, in order then to attack those who help one.--"But there is surely an *inner* difference there!" Naturally; only here "inner" is a dangerous metaphor. But the 'proof' that an inner difference is present is the very fact that I can *confess* that I was simulating. I confess an intention. Does it 'follow' from this that the intention was something inner?

Page 146

825. The 'actual infinite' is a 'mere word'. It would be better to say: for the time being this expression merely produces a picture--which so far hangs in the air; you still owe us its application. [Cf. Z 274.]

Page 146

826. An infinitely long row of marbles, an infinitely long rod. Imagine these coming into a kind of fairy-tale. What application, even though a fictitious one, might be made of this concept? Let us ask now, not: can there be such a thing? But: What do we imagine? So give free rein to your imagination! you can have things now just as you choose. You only need to say how you want them. So just make a verbal picture, illustrate it as you choose, by drawings, comparisons, etc. Thus you can--as it were--prepare a blueprint.--And now there remains the question how one can work from it. [Cf. Z 275.]

Page Break 147

827. "But how can the human spirit fly ahead of reality, and even *think* the unverifiable?"--Why should we not *speak* the unverifiable? For we ourselves made it unverifiable.

A false *appearance* is produced? And how can it be so much as *appear* like that? For don't you want to say that this *like that* too isn't even a description? Well then, in that case it is, not a *false* appearance, but one that robs us of our orientation. So that we just ask: How is it possible? [Cf. Z 259.]

828. As soon as the word was spoken, I wished I had not said it.--How did my wish relate to the word that was spoken?

I felt that the word was inappropriate, as soon as I had spoken it. But the *signs* I remember were only like slight indications. Minutiae, from which I might have been able perhaps to *guess* the intention, the wish.

There are occasions of shame--situations--and ashamed behaviour. As there are occasions of expectation and the behaviour of expectancy.

829. When a cat lies in wait by a mouse-hole--do I assume that it is thinking about the mouse?

When a robber waits for his victim--is it part of this, for him to be thinking of that person? *Must* he be considering this and that as he waits? Compare one who is doing such a thing for the first time, with one who has already done it countless times. (Reading.)

830. There might be a verb with the meaning: to formulate one's intention in words or other signs, out loud or in one's thoughts. This verb would not be equivalent in meaning to our 'intend'.

There might be a verb with the meaning: to act according to intention; and this would also not mean the same as "to intend".

Yet another might mean: to brood over an intention; or, to turn it over and over in one's head. [Cf. Z 49.]

831. When I make my coffee, I intend to drink it. If I were making it without this intention--would some accompaniment of my action then have to be *lacking*? Does something go on during the normal doing of a thing, which characterizes it as doing with this intention? But if someone were to ask me whether I intend to drink, and I replied "Yes, of course"--would I be saying something about my present state?

This is how I react in this case; and *that* can be gathered from my reaction.

832. A belief, a wish, a fear, a hope, a fondness; each can be called a state of a man; we can count on this state in our behaviour towards this man, we can infer his reactions from his state.

And if someone says: "All this time I had the belief...", "All my life I have wished..." etc; he is reporting a state, an attitude.--But if he says "I believe he's coming" (or simply "Here he comes") or "I wish you'd come" (or "Please come"), then he is acting, he is speaking, according to that condition, not reporting that it is to be found in him.

But if that were right, then there ought to be a present form of that report, and hence on the one hand the *utterance* "I believe...", and on the other the *report* "I am in the state of belief...". And similarly for wish, intention, fear etc.

833. Someone might relate: "I remember my state in those years exactly; whenever I was asked... I replied...; that was my attitude."

834. There is a *reaction* of loathing, in myself and in others; there are also *feelings of loathing*. And loathing, fear, affection, etc., resemble one another in this; but not hope, belief, etc.

835. Grief incessantly rehearses the sad thoughts. A thought may be sad, loathsome, enchanting etc.; but how does the expression shew that it is this thought, to which we have these reactions? How does one drive a thought away?

836. Ought I to call the whole field of the psychological that of 'experience'? And so all psychological verbs 'verbs of experience'. ('Concepts of experience.') Their characteristic is this, that their third person but not their first person is stated on grounds of observation. That observation is observation of behaviour. A subclass of concepts of experience is formed by the 'concepts of undergoing'. †1

'Undergoings' have duration and a course; they may run on uniformly or non-uniformly. They have intensity. They are not characters of thought. Images are undergoings. A subclass of 'undergoings' are 'impressions'. Impressions have spatial and temporal relations to one another. There are blend-impressions. E.g. blends of smells, colours, sounds. 'Emotions' are 'experiences' but not 'undergoings'. (Examples: sadness, joy, grief, delight.) And one might distinguish between 'directed emotions' and 'undirected emotions'. An emotion has duration; it has no place; it has characteristic 'undergoings' and thoughts; it has a characteristic expression which one would use in *miming* it. Talking under particular circumstances, and whatever else corresponds to that, is thinking. Emotions colour thoughts. One subclass of 'experiences' is the forms of 'conviction'. (Belief, certainty, doubt, etc.) Their expression is an expression of thoughts. They are not 'colourings' of thoughts. The directed emotions might also be called "attitudes". Surprise and fright are attitudes too, and so are admiration and enjoyment.

837. But where does *memory* belong, and where *attention*? One can remember a situation or occurrence *at a moment*. To that extent, then, the concept of memory is like that of instantaneous understanding or decision.

838. My own behaviour is sometimes, but *rarely* the object of my own observation. And this hangs together with the fact that I intend my behaviour. Even if an actor observes the expressions of his own face in a glass, or the musician attends closely to every note in playing, and judges it, this happens after all so that he shall direct his action accordingly. [Cf. Z 591.]

839. What does it mean, e.g. to say that self-observation makes my acting, my movements, uncertain?

I cannot observe myself unobserved. And I do not observe myself for the same purpose as I observe someone else. [Cf. Z 592.]

840. When a child stamps its feet and howls with rage, who would say it was doing this involuntarily? And why? Why is it assumed to be doing this not involuntarily? What are the *tokens* of voluntary action? Are there such tokens? What, then, are the tokens of involuntary movement? They don't happen in obedience to orders, like voluntary actions. There is "Come here!" "Go over there!" "Make this movement with your arm," but not "Have your heart beat faster". [Cf. Z 593.]

841. There is a peculiar combined play of movements, words, facial expressions etc., as of expressions of reluctance, or of readiness, which characterize the voluntary movements of the normal human being. When one calls the child, it doesn't come automatically: there is, for example, the gesture "I don't want to!" There is coming gladly, the decision to come, running away with signs of fright, the effects of being addressed, all the reactions of play, the signs of consideration and its effects. [Cf. Z 594.]

842. A tune went through my head. Was it voluntary, or involuntary? It would be an answer to say: I could also have had it being sung to me inwardly. And how do I know that? Well, because I can ordinarily interrupt myself if I want to.

843. How could I prove to myself that I can move my arm voluntarily? Say by telling myself "Now I'm going to move it" and now it moves? Or shall I say: "Simply by moving it"? But how do I know that I did it, and it didn't move just by accident? Do I in the end feel it after all? And what if my memory of earlier feelings deceived me, and these weren't at all the right feelings to decide the matter?! (And which are the right ones?) And then how does someone else know whether I moved my arm voluntarily? Perhaps I'll tell him: "Tell me to make whatever movement you like, and I'll do it in order to convince you." And what *do* you feel in your arm? "Well the usual feelings." There is nothing unusual about the feelings, the arm is not e.g. without feeling (as if it had 'gone to sleep'). [Cf. Z 595.]

844. A movement of my body, of which I don't know that it is taking place or has taken place, will be called involuntary.--But how is it when I merely *try* to lift a weight, and so there isn't a movement? What would it be like if someone involuntarily strained to lift a weight? Under what circumstances would *this* behaviour be called "involuntary"? [Cf. Z 596.]

845. Can't rest be just as voluntary as motion? Can't abstention from movement be voluntary? What better argument against a feeling of innervation? [Cf. Z 597.]

846. "That glance was not intended" sometimes means: "I didn't know that I gave such a look" or "I didn't mean anything by it".

847. It ought not to strike us as so much a matter of course that memory shews us the past inner, as well as the past outer, process.

848. Imagination is voluntary, memory involuntary, but calling something to mind is voluntary.

849. What a remarkable concept 'trying', 'attempting', is; how much one can 'try to do'! (To remember, to lift a weight, to notice; to think of nothing.) But then one might also say: What a remarkable concept 'doing' is! What are the kinship-relations between 'talking' and 'thinking', between 'talking' and 'talking to oneself'? (Compare the kinship-relations between the kinds of numbers.) [Cf. Z 598.]

850. One makes quite different inferences from involuntary movements and from voluntary ones: this *characterizes* voluntary movement. [Cf. Z 599.]

851. But how do I know that this movement was voluntary? I don't know it, I manifest it. [Cf. Z 600.]

852. "I am tugging as hard as I can." How do I know that? Do my muscular sensations tell me so? The words are a signal; and they have a *function*.

But am I *experiencing* nothing, then? Don't I experience something? something specific? A specific feeling of effort and of inability to do more, of reaching the limit? Of course, but these expressions say no more than "I'm tugging as hard as I can". [Cf. Z 601.]

853. It is important, however, that there are all these paraphrases! That one can describe care with the words "Ewiges Düstere steigt herunter"†1. I have perhaps never sufficiently stressed the importance of this paraphrasing.

Joy is represented by a countenance bathed in light, by rays streaming from it. Naturally that does not mean that joy and light *resemble* one another; but joy *it does not matter why*--is associated with light. To be sure, it might be that this association is taught the child when it learns to talk, that it is no more *natural* than the sound of

the words themselves--enough that it exists. ("Beethoven" and Beethoven's works.) [Cf. Z 517.]

854. Sorrow like the lead-gray sky?! And how can that be found out? By looking at a sorrowing man and at the sky? Or does the sorrowing man say it? And is it then true only for his sorrow, or for the sorrow of *anyone*?

855. But if someone now says that *his* sadness is like a grey cloud--, am I to believe it or not?--One might ask him whether the two are alike *in something*, in a particular respect. (Like, e.g. two faces; or like a sudden strong pain and a flare.) One may give relations--internal relations and connexions--between what one calls "intensities" for different impressions.

856. 'a is between b and c, and is closer to b than to c'--this is a characteristic relation between sensations of the same kind. That is to say, there is, for example, a language-game with the order: "Produce a sensation between *this* one and *this* one, and closer to the first than to the second." And also: "Name two sensations, such that *this* one comes between them." [Cf. Z 360.]

857. And here it is important that with *grey* one will get the answer "black and white", with *purple*, "blue and red", with *pink* "red and white"; but with *olive-green* one will not get "red and green". [Cf. Z 361.]

858. How does one realize that the expression of joy is not the expression of some bodily pain? (An *important*

question.)

Page 152

859. How does one know that the expression of enjoyment is not the expression of a sensation?

Page 152

860. To *pronounce* a figure this or that. Do you always pronounce the figure to be this or that while you see it? Of course: if asked what this figure presents, I should always say "A rabbit"†1; but I am no more continuously conscious of this, than of the fact that there is an actual table here. For if I always pronounce a picture a picture of this object, then I also pronounce any object a thing with this particular use, etc.

Page Break 153

Page 153

861. If someone notices for the first time that the picture is ambiguous, he might react, say with the exclamation: "Ah! a rabbit!" etc.; but still, when he now goes on seeing the picture continuously in one aspect, he won't want to keep on exclaiming "Ah! a...!"

Page 153

862. I want to say that the natural, primitive expression of the experience of an aspect would be such an exclamation; it might also be a lighting up of the eyes. (Something strikes me!)

Page 153

863. When I say I see this figure continuously red, that means that the description, that it is red--the description in words or by means of a picture--is continuously correct, without alteration; hence in contrast to *that* case, in which the picture alters. For the temptation is to describe the aspect with the words "I see it *like this*" *without* pointing to anything. And when one describes a face with its direction of glance as an arrow, one wants to say: "I see this → and not this: ←".

Page 153

864. What corresponds to continuous seeing as →, is that this description, without any variation, is the right one and *that* only means that the aspect did not change.

Page 153

865. Talk of hallucination!†1--What could there be queerer, than that this *dot*, the eye, seems to have a direction!

Page 153

866. When I think about the facial expression of this figure--what do I do, to be thinking about the expression ← and not →?

Page 153

867. When I think about the facial expression of this figure, contemplate it, what do I do to be contemplating the expression ← not →?

And this symbolism, I believe, has everything in it.

Page 153

868. It is as if one saw a picture: one time together with *one* group, and then another time with *another* one. "What does this mean: It is as if one saw...?" It means something like: *that* process might be a representative of the actual one, it would have the right 'multiplicity'.

Page 153

869. It is--contrary to Köhler--precisely a *meaning* that I see.

Page Break 154

Page 154

870. It might be said that one experiences *readiness* for a particular group of thoughts. (The germ of them.)

Page 154

871. It is as if the picture came to *rest* in one position (or another). As if it could in fact fluctuate, and then come to rest with a *particular* accentuation.

One says: "I see it now (or mostly) as *this*." It really feels to us as if the lines were now fitted together into *this* and not the other shape. Or as if they were put into *this* and not the other mould.

And yet all our concern can only be *this*: to describe the actual expression of our experience, which I am merely paraphrasing with all these pictures; to say what is *essential* to this expression.

Page 154

872. Could someone see the figure in *this* way or *this* way, if he could not advance from that to giving explanations, etc.? Thus, could someone see it in such-and-such a way, if he didn't know how animals' heads looked, what an eye

is etc.? And by this of course I don't mean: "Would such a person be competent to do so, would he succeed?" But rather: "Aren't *these concepts* requisite for this?"

Page 154

873. I see the picture of a horse: I know, not merely that it is a horse, but also that the horse is running. Thus I can understand the picture, not just *spatially*, but I also *know* what the horse is now about to do. Imagine someone seeing a picture of a cavalry charge but not knowing that the horses don't stay in their various places!

I am, however, not concerned with an *explanation* of this understanding, say by the assertion that someone who looks at such a picture makes tiny running movements, or feels running innervations. What ground is there for assumptions of this kind, except *this* one: it 'must' be like that?

Page 154

874. But suppose it is said: "One *sees* the painted horse running!" Here, however, I don't just mean to say "I know that this represents a running horse". One is trying to say something *else*. Imagine that someone reacted to such a picture by a movement of his hand and a shout of "Tally ho!". Doesn't that say roughly the same as: he sees the horse running? He might also exclaim "Its[[sic]] running!" and that would not be the observation that it is running, nor yet that it *seems* to be running. Just as one says "See how it runs!"--not in order to inform the other person; rather this is a reaction in which people are in touch with one another.

Page Break 155

Page 155

875. Understanding is like knowing how to go on, and so it is an ability: but "I understand", like "I can go on", is an *utterance*, a *signal*.

Page 155

876. I can experience a word substantivally or adjectivally. Do I know whether everyone, or many, of those with whom I talk, have these experiences? Would it be important for knowing what they mean?

Page 155

877. It hadn't occurred to me that the same contour occurred in both pictures, for in the one picture I took it like *this*, ® in the other like *this* → . Only in the course of consideration did I realize that the contour was the same--Is that a proof that I saw something *different* each time?--It is important that the two aspects are incompatible with one another.

Page 155

878. Is a facial expression something *visual*? I could imagine a picture, where the *expression* was ambiguous. And which perhaps for that reason I should not recognize in a different surrounding. In that case I say something like: "Ah well, the lines are the same; only here they look quite different."

And of course I do really *see* that the → picture and the ← picture are the same! I don't realize it only by making measurements, say!

Page 155

879. I see two different visual objects, you say, which merely have something in common with one another, In saying that you are only laying stress on some analogies at the expense of others. But now this emphasis needs to be grammatically justified.

Page 155

880. How is it possible that the eye, this *dot*, looks in a direction?--"See, it is looking!" (And here one 'looks' oneself.) But one doesn't say and do this continuously while one contemplates the picture. And now what is this "See, it is looking!"--is it the expression of a sensation? [Cf. P.I. p. 205i.]

Page 155

881. I would never have thought of laying the two pictures one on the other like *that*, of comparing them in *that* way. For they suggest a different method of comparison.

The ← picture hasn't even the slightest resemblance to the → picture, one would like to say--although they are congruent.

Page 155

882. "Now I can go on!"--I see that *that* is the front of a head, *that* is a beak--this line is brow-like, this dot is eye-like. But how can the *visual impression* of a line be brow-like? And what makes me say it is

Page Break 156

the visual impression that has this character?--Well, the fact that it isn't a thought, isn't an interpretation, that it has duration like a visual impression.

Page 156

883. Humans have intentions: Let us try to describe this fact! What would such a description be like? *For* whom

would it be a description? Ask yourself this: what purpose is it supposed to serve?

Page 156

884. One can speak to oneself very 'clearly' in the imagination, while at the same time one is reproducing the information of the speech by humming (with closed lips). Movements of the larynx help too. But the remarkable thing about the latter case is that one *hears* the speech in the imagination, and does not merely *feel* as it were its skeleton in the larynx. [Cf. P.I. p. 220e.]

Page 156

885. It is *essential* to 'imaging' that the concepts of sense-perception are used in the expression of it. (The sentence "I hear and don't hear..." might be used as the expression of auditory imagination. A use for the form of contradiction.) A principal mark that distinguishes image from sense-impression and from hallucination is that the one who has the image does not behave as an observer in relation to the image, and so that the image is voluntary.

Page 156

886. Imagine a conversation, one in which one party is yourself, and imagine it in such a way that you yourself are actually speaking in the imagination. What you yourself say, you will then probably feel in your body (in the larynx, in the breast). This, however, only describes and does not define the activity of talking in the imagination.

Page 156

887. The feeling of the uncanny. How is it manifested? The *duration* of such a 'feeling'. What is it like, e.g., for it to be interrupted? Would it be possible, for example, to have it and not have it every other second? Don't its marks include a characteristic kind of course (beginning and ending), distinguishing it from, e.g., a sense perception?

Page 156

888. The way music speaks. Don't forget that even though a poem is framed in the language of information, it is not employed in the language-game of information.

Might one not imagine someone who had never known music, and who came to us and heard someone playing a reflective piece of

Page Break 157

Chopin, being convinced that this was a language and people were merely keeping the sense secret from him?

Verbal language contains a strong musical element. (A sigh, the modulation of tone for a question, for an announcement, for longing; all the countless gestures in the vocal cadences.) [Cf. Z 160, 161.]

Page 157

889. "Don't look for anything behind the phenomena; they themselves are the theory." (Goethe.)

Page 157

890. I observe his face closely. Why? What does it tell me? Whether he is sad or cheerful, e.g., But why am I interested in that? Well, if I get to know his mood, it is like when I have got to know the condition of a body (its temperature, for example); I can draw various kinds of conclusion from this. And that is why I don't observe my own face in the same case. If I observed myself, my face would no longer be a reliable index; and even if it were an index for someone else, still I could not draw any conclusions from it.

Page 157

891. Being ashamed of a thought. Is one ashamed because one has pronounced such-and-such a sentence to oneself in the imagination?

The thing is, language has a multiple root; it has, not a single root, but roots. [Cf. Z 656.]

Page 157

892. "At that moment the thought was before my mind."--And how?--"I had the picture."--So was the picture the thought? No; for if I had merely communicated the picture to someone, he would not have got hold of the thought. [Cf. Z 239.]

Page 157

893. The picture was the key. Or at any rate it *seemed* like the key. [Cf. Z 240.]

Page 157

894. How are visual impressions distinguished from auditory impressions?--Am I to reply "That can't be said; but whoever sees and hears knows that they are *totally* different"? Could it be imagined that for some man *one* particular visual impression was the same as *one* particular auditory impression? so that he could receive this impression both through the eye and through the ear? Would this man point to a picture perhaps and strike a note on the piano and say that *these* two were identical? And would we believe him? And why not? Would we believe him when he said the 'affection of the soul' was the same in the two cases? And if we did believe it, how could we make use of the fact?

Page Break 158

895. The genealogical tree of psychological phenomena: I strive, not for exactness, but for a view of the whole. [Cf. Z 464.]

896. What holds the bundle of 'sense-impressions' together is their mutual relationships. That which is 'red' is also 'sweet' and 'hard' and 'cold' and 'sounds' when one strikes it. In the original language-game with these words it isn't "This looks red", but "This is red" (hard etc.) Our agreement is essential to the language-game. But with "pleasant", "unpleasant", "beautiful", "ugly", it is otherwise.

Pain is in some ways analogous to the other sense-impressions, in some ways different. There is a facial expression, there are exclamations and gestures of pain (as of joy), tokens of rejection, a reception that is characteristic of pain, but none that is characteristic of the sensation red. Bitterness is akin to pain in this.

We could imagine there being a sense impression without any sense organ. Someone might hear, and so he might learn pretty well all the language-games with the words for auditory impressions, without having ears, and without knowing what he hears *with*! For that one hears with the ears comes out relatively very seldom. It *might* be that someone hears as we all do, and it is only later discovered that his *ears* are deaf.

The *content* of experience. One would like to say "I see red *thus*", "I hear the note that you strike *thus*", "I feel pleasure *thus*", "I feel sorrow *thus*", or even "*This* is what one feels when one is sad, *this*, when one is glad", etc. One would like to people a world, analogous to the physical one, with these *thuses* and *thises*. But this makes sense only where there is a picture of *what is experienced*, to which one can point as one makes these statements.

897. If only *one* person had, *once*, made a bodily movement--could the question exist, whether it was voluntary or involuntary?

898. "When I make an effort, I surely *do* something, I surely don't merely have a sensation." And it is so too; for one tells someone "Make an effort!", and he may express the intention: "Now I'm going to make an effort" And when he says "I can't go on!" that does not mean: "I can't endure the feeling--the pain, for example--in my limbs any longer."--On the other hand one *suffers* with effort, as with pain. "I am utterly exhausted"--if someone said that, but moved as briskly as ever, one would not understand him. [Cf. Z 589.]

899. An aspect is subject to the will. If something appears blue to me, I cannot see it red, and it makes no sense to say "See it red"; whereas it does make sense to say "See it as...". And that the aspect is voluntary (at least to a certain extent) seems to be essential to it, as it is essential to imaging that *it* is voluntary. I mean: voluntariness seems to me (but why?) not to be a mere addition; as if one were to say: "This movement can, as a matter of experience, also be brought about in *this* way." That is to say: It is essential that one can say "Now see it like *this*" and "Form an image of...". For this hangs together with the aspect's not 'teaching us something about the external world'. One may teach the words "red" and "blue" by saying "This is red and not blue"; but one can't teach someone the meaning of "figure" and "ground" by pointing to an ambiguous figure. [Cf. P.I. p. 213e.]

900. We do not first become acquainted with images and only later learn to bend them to our will. And of course it is anyway quite wrong to think that we have been directing them, so to speak, with our will. As if the will governed them, as orders may govern men. As if, that is, the will were an influence, a force, or again: a primary action, which then is the cause of the outward perceptible action.

901. Is it right to say: what makes an action voluntary is the psychological phenomena in which it is embedded? (The psychological surrounding.)

Are, e.g., my normal movements in walking "voluntary" in a *non-potential* sense?

902. A child stamps its feet with rage: isn't that voluntary? And do I know anything about its sensations of movement, when it is doing this? *Stamping with rage is voluntary*. Coming when one is called, in the normal surroundings, is voluntary. Involuntary walking, going for a walk, eating, speaking, singing, would be walking, eating, speaking etc. in an abnormal surrounding. E.g. when one is *unconscious*: if for the rest one is behaving like someone in narcosis; or when the movement goes on and one doesn't know anything about it as soon as one shuts one's eyes; or if one can't adjust the movement however much one wants to; etc.

903. No supposition seems to me more natural than that there is no process in the brain correlated with associating

or with thinking; so that it would be impossible to read off thought-processes from

Page Break 160

brain-processes. I mean this: if I talk or write there is, I assume, a system of impulses going out from my brain and correlated with my spoken or written thoughts. But why should the *system* continue further in the direction of the centre? Why should this order not proceed, so to speak, out of chaos? The case would be like the following--certain kinds of plants multiply by seed, so that a seed always produces a plant of the same kind as that from which it was produced--but *nothing* in the seed corresponds to the plant which comes from it; so that it is impossible to infer the properties or structure of the plant from those of the seed that it comes out of--this can only be done from the *history* of the seed. So an organism might come into being even out of something quite amorphous, as it were causelessly; and there is no reason why this should not really hold for our thoughts, and hence for our talking and writing. [Cf. Z 608.]

Page 160
904. It is thus perfectly possible that certain psychological phenomena *cannot* be investigated physiologically, because physiologically nothing corresponds to them. [Cf. Z 609.]

Page 160
905. I saw this man years ago: now I have seen him again, I recognize him, I remember his name. And why does there have to be a cause of this remembering in my nervous system? Why must something or other, whatever it may be, be stored-up there *in any form*? Why *must* a trace have been left behind? Why should there not be a psychological regularity to which *no* physiological regularity corresponds? If this upsets our concepts of causality then it is high time they were upset. [Cf. Z 610.]

Page 160
906. The prejudice in favour of psycho-physical parallalism [[sic]] is also a fruit of the primitive conception of grammar. For when one admits a causality between psychological phenomena, which is not mediated physiologically, one fancies that in doing so one is making an admission of the existence of a soul *alongside* the body, a ghostly mental nature. [Cf. Z 611.]

Page 160
907. Must the verb "I believe" have a past tense form? Well, if instead of "I believe he's coming" we always said "He could be coming" (or the like), but nevertheless said "I believed..."--in this way the verb "I believe" would have *no present*. It is characteristic of the kind of way in which we are apt to regard language, that we believe that there must after all in the last instance be uniformity,

Page Break 161
symmetry: instead of holding on the contrary that it doesn't *have* to exist.

Page 161
908. Imagine the following phenomenon. If I want someone to take note of a text that I recite to him, so that he can repeat it to me later, I have to give him paper and pencil, while I am speaking he makes lines, marks, on the paper; if he has to reproduce the text later he follows those marks with his eyes and recites the text. But I assume that what he has jotted down is not *writing*, it is not connected by rules with the words of the text; yet without these jottings he is unable to reproduce the text; and if anything in it is altered, if part of it is destroyed, he gets stuck in his 'reading' or recites the text uncertainly or carelessly, or cannot find the words at all.--This *can* be imagined!--What I called jottings would not be a *rendering* of the text, not a translation, so to speak, in another symbolism. The text would not be *stored up* in the jottings. And why should it be stored up in our nervous system? [Cf. Z 612.]

Page 161
909. Why should not the initial and terminal states of a system be connected by a natural law, which does not cover the intermediary state? (Only don't think of *agency*). [Cf. Z 613.]

Page 161
910. What is called an alteration in concepts is of course not merely an alteration in what one says, but also in what one does.

Page 161
911. One sees the terminology, but fails to see the technique of applying it.

Page 161
912. One says: "He appears to be in frightful pain" even when one hasn't the faintest doubt, the faintest suspicion that the appearance is deceptive. Now why doesn't one say "I appear to be in frightful pain" for this too must at the very least make *sense*? I might say it at an audition; and equally "I appear to have the intention of..." etc. etc. Everyone will say: "Naturally I don't say that; because I *know* whether I am in pain." It doesn't ordinarily *interest* me to know whether I appear to be in pain; for the conclusions which I draw from this impression in the case of other

people, are ones I don't draw in my own case. I don't say "I'm groaning dreadfully, I must see a doctor", but I may very well say "He's groaning dreadfully, he must...".

Page Break 162

Page 162

913. If this makes no sense: "I know that I am in pain"--and neither does "I feel my pains",--then neither does it make sense to say: "I don't bother about my own groaning because *I know* that I am in pain"--or--"because I *feel* my pains."

So much, however, is true: I don't bother about my groaning. [Cf. Z 538.]

Page 162

914. I infer from observation of his behaviour that he must go to the doctor; but I do *not* make this inference for myself from observation of my behaviour. Or rather: I do that too sometimes, but *not* in analogous cases. [Cf. Z 539.]

Page 162

915. Here it is a help to remember that it is a primitive reaction to take care of, to treat, the place that hurts when someone else is in pain, and not merely when one is so oneself--hence it is a primitive reaction to attend to the pain-behaviour of another, as, also, *not* to attend to one's own pain-behaviour. [Cf. Z 540.]

Page 162

916. What, however, is the word "primitive" meant to say here? Presumably, that the mode of behaviour is *pre-linguistic*: that a language-game is based *on it*: that it is the prototype of a mode of thought and not the result of thought. [Cf. Z 541.]

Page 162

917. It can be called "putting the cart before the horse" to give an explanation like the following: we took care of the other man, because going by analogy with our own case, we believed that he too had the experience of pain.--Instead of saying: Learn from this particular chapter of our behaviour--from this language-game--what are the functions of "analogy" and of "believing" in it. [Cf. Z 542.]

Page 162

918. "How does it come about that I see the tree standing up straight even if I incline my head to one side, and so the retinal image is that of an obliquely standing tree?" Well how does it come about that I speak of the tree as standing up straight even in these circumstances?--"Well, I am conscious of the inclination of my head, and so I supply the requisite correction in the way I take my visual impression."--But doesn't that mean confusing what is primary and what is secondary? Imagine that we knew *nothing at all* of the inner structure of the eye--would this problem make an appearance? We do *not* in truth supply any correction here--that explanation is gratuitous.

Well--but now that the structure of the eye is known--*how does it*

Page Break 163

come about that we act, react, in this way? But must there be a physiological explanation here? Why don't we just leave explaining alone?--But you would never talk like that, if you were examining the behaviour of a machine!--Well, who says that a living creature, an animal body, is a machine in this sense?--[Cf. Z 614.]

Page 163

919. One may note an alteration in a face and describe it by saying that the face assumed a harder expression--and yet not be able to describe the alteration in spatial terms. This is enormously important.--Perhaps someone now says: if you do that, you just aren't describing the alteration of the face, but only the effect on yourself; but then why shouldn't a description using concepts of shape and colour be that too?

Page 163

920. One may also say: "He made *this* face" or "His face altered like *this*", imitating it--and again one can't describe it in any other way. ((There just are many more language-games that are dreamt of in the philosophy of Carnap and others.))

Page 163

921. Consciousness that... may disturb me in my work; knowledge can't.

Page 163

922. How do I know that a dog is hearing something continuously, is having a continuous visual impression, that it feels joy, fear, pain?

What do I know of the 'experience contents' of a dog?

Page 163

923. Are the *colours* really brethren? Are they different only in colour, not also in kind? Are sight, hearing, taste really brethren?

Don't look only for similarities in order to justify a concept, but also for connexions. The father transmits his name to the son even if the latter is quite unlike him.

Page 163

924. Compare a dreadful fright and a sudden violent pain. It is the sensation of pain that is dreadful--but is it the sensation of fright? When someone falls headlong in my presence,--is that merely the cause of an extremely unpleasant sensation in *me*? And how can this question get answered? Does someone who reports the frightful incident complain of the sensation, the catching of breath, etc.? If one

Page Break 164

wants to help someone get over the fright, does one treat the body? Doesn't one much more soothe him about the event, the occasion?

Page 164

925. If someone imitates grief for himself in his study, he will indeed readily be conscious of the tensions on his face. But really grieve, or follow a sorrowful action in a film, and ask yourself if you were conscious of your face. [Cf. Z 503.]

Page 164

926. One tie-up between moods and sense-impressions is that we use the concepts of mood to describe sense-impressions and images. We say of a musical theme, or a landscape, that it is sad, cheerful etc. But naturally it is much more important that we use all the concepts of mood to describe human faces, actions, behaviour. [Cf. Z 505.]

Page 164

927. Consciousness in the face of another. Look into someone else's face and see the consciousness in it, and also a particular *shade* of consciousness. You see on it, in it, joy, indifference, interest, excitement, dullness etc. The light in the face of another.

Do you look within *yourself*, in order to recognize the fury in *his* face? It is there as clearly as in your own breast.

(And what does one want to say? That someone else's face stimulates me to imitate it, and so that I feel small movements and muscular tensions on my own part, and *mean* the sum of these? Nonsense! Nonsense,--for you are making suppositions instead of just describing. If your head is haunted by explanations here, you will neglect to bear in mind the facts which are most important.) [Cf. Z 220.]

Page 164

928. Knowledge, opinion, have no facial expression. There is a tone, a gesture of conviction all right, but only if something is said in this tone, or with this gesture.

Page 164

929. "Consciousness is as clear in his face and behaviour, as in myself." [Cf. Z 221.]

Page 164

930. What would it mean for me to be wrong about his having a mind, having consciousness? And what would it mean to say I was wrong and didn't have any myself? What would it mean to say "I am not conscious"?--But don't I know that there is a consciousness in me?--Do I know it then, and yet the statement that it is so has no purpose?

Page Break 165

Page 165

And how remarkable that one can learn to make oneself understood to others in this matter! [Cf. Z 394.]

Page 165

931. A man can pretend to be unconscious; but *conscious*? [Cf. Z 395.]

Page 165

932. What would it be like for someone to tell me with complete seriousness that he (really) did not know whether he was dreaming or awake?--

Is the following situation possible: Someone says "I believe I am now dreaming"; he actually wakes up soon afterwards, remembers that utterance in his dream and says "So I was right!"--This narrative can surely only signify: Someone dreamt that he had said he was dreaming.

Imagine an unconscious man (anaesthetized, say) were to say "I am conscious" should we say "He ought to know"?

And if someone talked in his sleep and said "I am asleep"--should we say "He's quite right"?

Is someone speaking untruth if he says to me "I am not conscious"? (And truth, if he says it while unconscious? And suppose a parrot says "I don't understand a word", or a gramophone: "I am only a machine"?)
[Cf. Z 396.]

933. Suppose it were part of a day-dream I was having to say: "I am merely engaged in phantasy", would this be *true*? Suppose I write such a phantasy or narrative, an imaginary dialogue, and in it I say "I am engaged in phantasy"--but, when I write it down,--how does it come out that these words belong to the phantasy and that I have not emerged from the phantasy?

Might it not actually happen that a dreamer, as it were emerging from the dream, said in his sleep "I am dreaming"? It is quite imaginable there should be such a language-game.

This hangs together with the problem of 'meaning'. For I can write "I am healthy" in the dialogue of a play, and so not *mean* it, although it is true. The words belong to this and not that language-game. [Cf. Z 397.]

934. 'True' and 'false' in a dream. I dream that it is raining, and that I say "It is raining"--on the other hand: I dream that I say "I am dreaming". [Cf. Z 398.]

935. Has the verb "to dream" a present tense? How does a person learn to use this? [Cf. Z 399.]

936. One language-game analogous to a fragment of another. A space projected into bounded bits of a space. [Cf. Z 648.]

937. Suppose I were to have an experience like waking up, were then to find myself in quite different surroundings, with people who assure me that I have been asleep. Suppose further I insisted that I had not been dreaming, but living in some way outside my sleeping body. What function has this assertion? [Cf. Z 400.]

938. "I have consciousness"--that is a statement about which no doubt is possible." Why should that not say the same as: "I have consciousness' is not a proposition"?

It might also be said: What's the harm if someone says that "I have consciousness" is a statement admitting of no doubt? How do I come into conflict with him? Suppose someone were to say this to me why shouldn't I get used to making no answer to him instead of starting an argument? Why shouldn't I treat his words like his whistling or humming? [Cf. Z 401.]

939. "Nothing is so certain as that I possess consciousness." In that case, why shouldn't I let the matter rest? This certainty is like a mighty force whose point of application does not move, and so no work is accomplished by it. [Cf. Z 402.]

940. Someone playing dice throws first a 5 and then a 4 and says "If I had only thrown a 4 instead of the 5, I should have won"! The condition is not physical but only mathematical, for one might reply: "If you had thrown a 4 first, who knows what you would have thrown next!" [Cf. Z 678.]

941. If you now say: "The use of the subjunctive rests on belief in natural law" one may retort: "It does not *rest* on that belief; it and that belief stand on the same level." [Cf. Z 679.]

942. Fate stands in contrast with natural law. One wants to find a foundation for natural law and to use it: not so with fate. [Cf. Z 680; V.B., p. 119; C. & V., p. 61.]

943. The concept of a 'fragment'. It is not easy to describe the use of this word *even only roughly*.

944. When we want to describe the use of a word,--isn't it like wanting to make a portrait of a face? I see it clearly; the expression of these features is *well* known to me; and if I had to paint it I shouldn't know where to begin. And if I do actually make a picture, it is wholly inadequate.--If I had a description in front of me I'd recognize it, perhaps even detect mistakes in it. But my being able to do that does not mean that I could myself have given the description.

945. Two objects 'belong together'. One teaches a child to 'arrange' things, accompanying this activity with the words "These belong together". The child learns this expression as well. It might even arrange things *with the help* of these

words and certain gestures. But the words may also be a mere accompaniment of the doing. A language-game.

Imagine such a game played without words, but with the accompaniment of music that fitted the actions.

Page 167

946. "Put it here"--saying which I point to the place with my finger--this is an *absolute* specification of place. And if someone says that space is absolute, he might produce as an argument for this: "There is after all a *place: here*." [Cf. Z 713.]

Page 167

947. The 'experience of similarity'. Think of the language-game "recognizing similarities", or "giving similarities", or "arranging things according to their similarity". Where is the special experience here? The special experience content that one is after?

Page 167

948. The duration of sensation. Compare the duration of a sensation of sound with the duration of the tactile sensation that tells you you have a ball in your hand; and with the "feeling" that tells you that your knee is bent. And here again we have a reason why we should like to say of the sensation of posture that it has no content. [Cf. Z 478.]

Page 167

949. Philosophical investigations: conceptual investigations. The essential thing about metaphysics: that the difference between factual and conceptual investigations is not clear to it. A metaphysical question is always in appearance a factual one, although the problem is a conceptual one. [Cf. Z 458.]

Page 167

950. What is it, however, that a conceptual investigation does? Does it belong in the natural history of human concepts?--Well, natural history, we say, describes plants and beasts. But might it not be that

Page Break 168

plants had been described in full detail, and then for the first time someone realized the analogies in their structure, analogies which had never been seen before? And so, that he establishes a new order among these descriptions. He says, e.g., "compare this part, not with this one, but rather with that" (Goethe wanted to do something of the sort) and in so doing he is not necessarily speaking of *derivation*; nonetheless the new arrangement *might* also give a new direction to scientific investigation. He is saying "Look at it like *this*"--and that may have advantages and consequences of various kinds.

Page 168

951. Why do we count? Has it proved practical? Do we have our concepts, e.g. the psychological ones, because it has proved to be advantageous? And yet we do have *certain* concepts just for that reason; they were introduced for that reason. [Cf. Z 700.]

Page 168

952. One ought not to think it a simplification to bring seeing with one eye under consideration, instead of seeing with both eyes; if, that is, one is clear about the fact that one doesn't feel seeing in the eyes. It is far more difficult to carry the idea of the visual object through for binocular vision. For what is the binocular 'optical image'?

'The portrait of what one really *sees*' of the visual impression itself'.

Page 168

953. It occurs to someone: If I only had the right things and colours at my disposal, I could *exactly* represent what I see. And up to a point it actually is so. And that report of what I have before me, and the description of what I see, have the same form.--But they quite leave out, e.g., the wandering of the gaze. Not that alone, though, but also, e.g., the reading of a script in the visual field and any aspect of what is seen.

Page 168

954. Now if what you are looking at is a big tablet or flat wall, with a figure on it, then a picture of this figure may

count as an exact description. If the figure is, e.g., an *F*, what more can one want than that it is copied exactly? and yet there is besides a quite different description, which is not there in the copying. And similarly when the figure is a face.

Page 168

955. What in *one* sense is a slight inaccuracy of description, in another is a large one.

Page Break 169

Page 169

956. Active and passive. Can one order someone to... or not? This perhaps seems, but is not, a far-fetched distinction. It resembles this one: Can one (*logical* possibility) decide to... or not?"--And that means: How is it surrounded by thoughts, feelings etc.? [Cf. Z 588.]

Page 169

957. What would a society all of deaf people look like? Or a society of 'mental defectives'? An *important question!* What, that is, would a society be like, that never played a lot of our ordinary language-games? [Cf. Z 371.]

Page 169

958. Being conscious of the identity of colours in a picture, or of *this* colour's being darker than that one.

While I am hearing this piece, am I conscious the whole time of its being by...?

When is one *conscious* of a fact?

Page 169

959. Love is not a feeling. Love is put to the test, pain is not. [Cf. Z 504.]

Page 169

960. I see something *in different connexions*. (Isn't this more closely related to imagining than to seeing?)

Page 169

961. It is as if one had brought a concept to what one sees, and one now sees the concept along with the thing. It is itself hardly visible, and yet it spreads an ordering veil over the objects.

Page 169

962. "What do you see?" (Language-game)--"What do you *actually* see?"

Page 169

963. Let us represent seeing to ourselves as something enigmatic!--without introducing any kind of physiological explanation.--

Page 169

964. The question "What do you see?" gets for answer a variety of kinds of description.--If now someone says "After all, I see the aspect, the organization, just as much as I see shapes and colours"--what is that supposed to mean? That one includes all that in 'seeing'? Or that here there is the greatest similarity?--And what can I say to the matter? I can point out similarities and differences.

Page 169

965. Mightn't it be taken for madness, when a human being recognizes a drawing as a portrait of NN and exclaims "That's Mr. NN!"--"He must be mad", they say, "He sees a bit of paper with black lines on it and takes it for a human!"

Page Break 170

Page 170

966. 'Seeing the figure *as...*' has something occult, something ungraspable about it. One would like to say: "Something has altered, and nothing has altered."--But don't try to explain it. Better look at the rest of seeing as something occult too.

Page 170

967. The expression of that experience is and remains "I see it as a mountain", "I see it as a wedge", "I see it with this base and this apex, but fallen over", etc. And the words "mountain", "wedge", "base", "fallen over" are after all only marks, or noises--*with a use*.

Page 170

968. Think of a representation of a face from in front and in profile at the same time, as in some modern pictures. A representation in which a movement, an alteration, a roving of one's glance, are included. Does such a picture *not really* represent what one sees?

Page 170

969. "I forgive you." Can one say "I am busy forgiving you"? No. But that doesn't mean that there is not a process, which one might--but does not--call "forgiving": I mean carrying on the inward struggle that may lead to forgiving.

Page 170

970. I should like to say: there are aspects which are *mainly* determined by thoughts and associations, and others that are 'purely optical', these make their appearance and alter automatically, almost like after-images.

Page 170



971.

Page 170

What Köhler†1 does not deal with is the fact that one may *look at* figure 2 in this way or that, that the aspect

is, at least to a certain degree, subject to the will.

Page 170

972. I may attend to the course of my pains, but not in the same way to that of my believing or knowing. [Cf. Z 75.]

Page 170

973. The observation of duration may be continuous, or interrupted.

Page Break 171

Page 171

How do you observe your knowing, your opinions? and on the other hand, an after-image, a pain? Is there such a thing as uninterrupted observation of my capacity to carry out the multiplication...? [Cf. Z 76-7.]

Page 171

974. ((On no. 971)) One *might* use the fact that the aspect is connected with eye-movements, to explain that.

Page 171

975. Analogy with the contrast between the 'value' and the 'limiting value' of a function. ((important))

Page 171

976. That an aspect is subject to the will is not something that does not touch its very essence. For what would it be like, if we could see things arbitrarily as red or green? How in that case would one be able to learn to apply the words "red" and "green"? First of all, in that case there would be no such thing as a 'red object', but at most an object which one more easily sees red than green.

Page 171

977. Isn't what Köhler says roughly: "One couldn't *take* something for this or that, if one couldn't *see* it as this or that"? Does a child start by seeing something this way or that, before it learns to take it for this or that? Does it first learn to answer the question "How do you see that?" and only later "What *is* that?"--

Page 171

978. Can one say it must be capable of grasping the chair visually as a whole, in order to be able to recognize it as a thing?--Do I grasp that chair visually as a thing, and which of my reactions shews this? Which of a man's reactions shew that he recognizes something as a thing, and which, that he *sees* something as a whole, thingishly?

Page 171

979. One might imagine the matter like this: One tests how a child copies flat figures, when one has not taught it any kind of copying, and when it hasn't yet even seen 3-dimensional objects.

Page 171

980. I learn to describe what I see; and here I learn *all sorts of* language-games.

Page 171

981. Not: "How can I describe what I see?"--but "What does one call 'description of what is seen?'"
And the answer to *this* question is "A great variety of thing".

Page Break 172

Page 172

982. Köhler†1 says that very few people would of their own accord see the figure 4 in the drawing

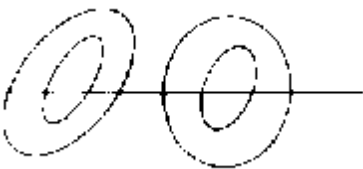

and that is certainly true. Now if some man deviates radically from the norm in his description of flat figures or when he copies them, what difference does it make between him and normal humans that he uses different '*units*' in copying and describing? That is to say, how will such a one go on to differ from normal humans in yet other things?

Page 172

983. A man might be highly gifted at drawing, I mean he might have the talent to copy objects, a room for instance, very exactly, and yet he might keep on making small mistakes against *sense*; so that one could say "He doesn't grasp an object as an object". He would never, e.g., make a mistake like that of the painter Klecksel, who paints two eyes in the profile. His *knowledge* would never mislead him.

Page 172

984. The misleading concept is "the *complete* description of what one sees".

Page 172

985. Always eliminate the private object for yourself, by supposing that it keeps on altering: you don't notice this,

however, because your memory keeps on deceiving you. [Cf. P.I. p. 207e.]

Page 172

986. "Anyone who sees something sees something particular"--but that doesn't tell us anything.

It is as if one wanted to say "Even if no representation is like the visual impression, still, it is like itself".

Page 172

987. It is quite possible that someone who was asked "What do you see here?" might copy the figure correctly, but given the question "Do you see a 4?", he might answer with a "No", although he has himself formed it in making his copy.

Page 172

988. What do I tell someone, to whom I give the information that I am now seeing the ornament like *this*? (A queer question)--This means "In what language-game does this sentence find employment?"--"What are we doing with this sentence?"

Page 172

989. Let us suppose that certain aspects could be explained by the movement of the eye. In that case one would like to say that those

Page Break 173

aspects were of a purely optical character; and so there would have to be a description of them which did not have to make use of analogies from other domains. Then one would have to be able to replace the order: "See this as..." by: "Have your gaze shift in such and such a way" or the like.

Page 173

990. But it is not true that an experience which is traceably connected with the movement of the eyes, an experience that can be produced by such a movement, can for that reason be described by means of a sequence of optical images.

(Any more than someone who imagines a note is imagining a sequence of disturbances of the air.)

Page 173

991. Hold the drawing of a face upside-down and you can't tell the *expression* of the face. Perhaps you can see that it is smiling, but you won't be able to say what *sort* of a smile it is. You wouldn't be able to imitate the smile or describe its character more exactly.

And yet the upside-down picture may represent the object extremely accurately. [Cf. P.I. p. 198f.]

Page 173

992. One needs to remember that seeing-as may have an effect like that of an alteration of what is seen, e.g. by putting between brackets, or underlining, or making a connexion of one kind or another etc., and that in this way again there is a similarity between seeing-as and imagining.

No one, after all, will deny that underlining or insertion of brackets may foster the recognition of a similarity.

Page 173

993. It is clear that only someone who sees the ambiguous picture as a rabbit will be able to imitate the expression on the face of the rabbit. So if he sees the picture in *this* way, this will enable him to judge a particular kind of resemblance.

Page 173

994. One will also estimate certain dimensions correctly, only if one sees the picture in *this* way.

Page 173

995. Remember that one may say: "You have to hear the tune like *this*, and then also *play* it correspondingly".

Page 173

996. Might there not be humans who don't calculate in their heads and can't easily learn silent reading, but who were otherwise intelligent and in no sense 'defective'?

Page 173

997. There is no doubt that one often evokes an aspect by means of a movement of the eyes, by shifting one's gaze.

Page Break 174

Page 174

998. But how queer! one would like to say--if one can discover a kind of composition,--how is it possible also to *see* it?!--How is it possible to know in a flash what one wants to say? Isn't that equally remarkable?

Page 174

999. For is the phenomenon of the aspect queerer than my memory of a particular actual person, of whom I have a memory image? There is even a similarity between the two things. For here too one asks oneself: How is it *possible*

that I have a memory-image of *him* and that there is no doubt about its being an image of *him*?

Page 174

1000. Philosophy often solves a problem merely by saying: "*Here* is no more difficulty than *there*."

That is, just by conjuring up a problem, where there was none before.

It says: "Isn't it just as remarkable that...", and leaves it at that.

Page 174

1001. How does one obey the order "Imagine Mr. N"? How does one know that the order has been obeyed? how does anyone know that he has obeyed it? What use is the *state* of having a image here?--I want to say that the situation with seeing an aspect is similar.

Page 174

1002. I now see it (the chess-board) like this: It is as if you had given me this schematic drawing. E.g.:

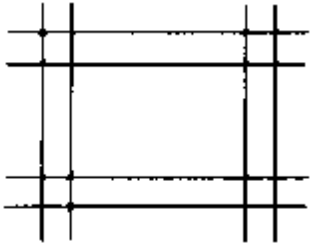

or

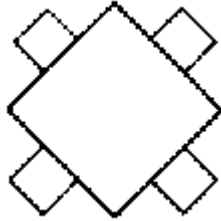

determined.

But the figure as which I see the other, is not unambiguously

Page 174

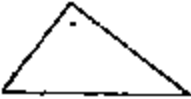
1003. Imagine a film representation of a triangle  swinging around the point and then at rest. And now it might be as if this temporal surrounding still had an effect in the picture of the triangle come to rest.

"Hanging", I should like to say. But does nothing correspond to that? Certainly something does! But that only means that I am not lying, and that the expression of the aspect has a use. "*What application?*", you must always ask yourself.

Page Break 175

Page 175

1004. One might regard the drawing of the chess board as a blueprint according to which pieces were to be constructed which yield the chess-board. Now this drawing may be used in various ways; and one can also *see* it in various ways, correspondingly to the different uses.

Page 175

1005. Suppose we explained this by saying the aspect comes about through different images and memories superimposed on the optical image. Naturally this explanation does interest me, not as an explanation but as a logical possibility, hence conceptually (mathematically).

Page 175

1006. "The green that I see over there is *leafy*. Those things there are *eye-like*." (What things?)

Page 175

1007. What cannot be an object of sight here seems to be an object of sight. As if one were to say one saw sounds. (But one really does say that one sees a vowel yellow, or brown.)

Page 175

1008. For how could association be a lasting state? How could I associate this kind of object with these lines for five minutes?

Page 175

1009. What convinces me that someone else sees an ordinary picture three-dimensionally?--That he says so?--Rubbish--for how do I know what he means by assuring us of this?

Well, it's that he knows his way about in the picture; the expressions he applies to it are the ones that he applies to space; confronted with a picture of a landscape, he behaves as he does when confronted with a landscape, etc. etc.

Page 175

1010. I can never know, about him, whether he really sees. Well then of course I can't know it of myself either. For how do I know that I am now calling the same thing that as before, and that I am calling the same thing "same"?

Page 175

1011. Now, how does it all look in the third person? And what is valid for the third person is then valid, however queer this may sound, for the first person too.

Page 175

1012. Imagine a physiological explanation for my seeing *one* thing (A) as a variation of the *other* (B). It might come out that when I see A as B certain processes take place on my retina, which otherwise are found when I actually see B. And this might now explain some things

Page Break 176

in my behaviour. It might, e.g., be said that that is the reason why on seeing A I behave as if I were seeing B, a way I don't ordinarily behave when I see A but don't see it as B. But for us this explanation of my behaviour is superfluous. I accept the behaviour just as I accept a process on the retina or in the brain.

I want to say: At first the physiological explanation is apparently a help, but then at once it turns out to be a mere catalyst of thoughts. I introduce it only to rid myself of it again at once.

Page 176

1013. Just do *not* fancy that you'd know in advance what "state of seeing" means in this case. Have the use *TEACH* you the meaning.

Page 176

1014. Could I have made the phenomenon of having an image clear to myself, if I had been told: someone whose eyes are open sees something that is not there before him, and at the same time also sees what is before him, and the two visual objects don't get in each other's way?!

Page 176

1015. And naturally it would be quite wrong to say: "And yet queer things do happen", or "incredible things". Rather what happens is *not* queer and is just wrongly seen as queer.

Page 176

1016. The old idea of the role of *intuition* in mathematics. Is this intuition the seeing of the complexes in different aspects?

Page 176

1017. Doesn't one have to distinguish among aspects, separating the purely optical from the rest?

That they are very different from one another is clear: the dimension of depth, for example, sometimes comes into their description, and sometimes not; sometimes the aspect is a particular 'grouping'; but when one sees lines as a face, one hasn't taken them together merely visually to form a group; one may see the schematic drawing



of a cube as an open box or as a solid body, lying on its side or standing up; the figure: can be seen, not just in two but in very many different ways.

Page 176

1018. One hangs up pictures, photographs, of landscapes, interiors, human beings, and does not regard them as working drawings. One likes to look at them, as at the objects themselves; one smiles at the

Page Break 177

photograph as at the human being that it shews. We don't learn to understand a photograph as we do a blue-print.--It would of course be possible that we had first to learn with some pains to understand a method of depiction, in order to be able later on to use it as a natural picture. Still this troublesome learning would later on be mere *history*, and then we should regard the picture just as we now regard our photographs.

Page 177

1019. There might also be men who did not understand, did not see, photographs as we do; who did indeed understand that a human being *can* be represented in this way, who were also able to judge his shape roughly from a photograph, but who all the same did not see the picture as a picture. *How* would that be manifested? What would we regard as the expression of it?? That is perhaps not easy to say.

These people would perhaps not take pleasure in photographs as we do. They would not say "Look at his smile!" and the like; they would often not recognize a person straight off from his picture; would have to *learn to read* the photograph, and have to *read* it; they would be in a difficulty to recognize two good snapshots of the same face as pictures of somewhat different positions.

Page 177

1020. If someone were to tell me that he had seen the figure for half an hour without a break as a reversed F, I'd have to suppose that he had kept on *thinking* of this interpretation, that he had *occupied* himself with it.

Page 177

1021. It is as if the aspect were something that only dawns, but does not remain; and yet this must be a *conceptual* remark, not a psychological one.

1022. When the aspect suddenly changes one experiences the second phase in an acute way (corresponding to the exclamation "Oh, it's a...!") and here of course one does *occupy* oneself with the aspect. In the temporal sense the aspect is only the kind of way in which we again and again treat the picture.

1023. 'Object' and 'ground'--Köhler wants to say--are visual concepts, like red and round. The description of what is *seen* includes mentioning what is object and what is ground no less than colour and shape. And the description is just as incomplete when it isn't said what is object and what ground, as it is when colour or shape are not given. I see the one as immediately as the other one wants to say. And what objection is there to make to this? First: how this gets

recognized--whether through introspection, and whether everyone has got to agree about it. For the question obviously concerns the description of the *subjectively seen*. But just how does one learn to use words to report the subjective? And what can these words mean to us?

Suppose that, instead of words, it were a matter of reproducing by drawing; and in this reproduction what corresponded to the words "object-like" and so on were the sequence, the order, in which we made the drawing. (I am assuming we can draw extraordinarily fast.) And now suppose someone said: "The sequence belongs to the representation of what is seen just as much as colours and shapes do."--What would that mean?

One may very well say: There are reasons for counting not only the drawn picture as part of a description-by-drawing of what is seen but also the phrasing that goes on in making the drawing. Somehow these reactions of the one who is giving the description belong together. In certain respects they do belong together, in others they do not.

1024. If one thinks of the currents on the retina (or the like) one would like to say: "So the aspect is just as much 'seen' as are the shape and colour." But then how can such an hypothesis have helped us to form this conviction? Well, it favours the tendency to say here that we were *seeing* two different structures. But if this tendency can be given a ground, its ground must be somewhere else.

1025. The expression of the aspect is the expression of a way of taking (hence, of a way-of-dealing-with, of a technique); but used as description of a state.

1026. When it looks as if there were no room for such a logical form, then you must look for it in another dimension. If there is no room for it here, then there is in another dimension. [Cf. P.I. p. 200f.]

1027. In this sense there is also no room for imaginary numbers in the number-line. And that surely means: the application of the concept of an imaginary number is *radically* different from that of, say, a cardinal number; more different than the mathematical operations alone reveal. In order, then, to get place for them, one must descend to their application and then they find a, so to speak *undreamt of*, different place. [Cf. P.I. p. 201a.]

1028. If this constellation is always and continuously a face for me, then I have not named an *aspect*. For *that* means that I always *encounter*

it as a face, treat it as a face; whereas the peculiarity of the aspect is that I see something into a picture. So that one might say: I see something that isn't there at all, that does not reside in the figure, so that it may surprise me that I can see it (at least, when I reflect upon it afterwards).

1029. If the seeing of an aspect corresponds to a thought, then it is only in a *world* of thoughts that it can be an aspect.

1030. If I am describing an aspect, the description presupposes concepts which do not belong to the description of the figure itself.

1031. Is it not remarkable, that in describing a visual impression one so uncommonly seldom includes the roving of the gaze in the description?! It is as good as never included when the object is small, is, e.g. a face; although here too after all the gaze is continually shifting.

1032. This aspect may suddenly change and then a new looking follows the change. One is conscious of, e.g., the facial expression, one *contemplates* it.

1033. I may, e.g., be looking at a photograph and be occupied with the expression of the face, may so to speak bring it home to myself, without saying anything to myself or to anyone else as I do so.

I make the eyes of the photograph speak to me. Perhaps I am seeing the picture for the first time as a real face. 'Enter into the expression.' Ask, not "What goes on here?" but rather "What does one do with this utterance?"

1034. We become conscious of the aspect only when it changes. As when someone is conscious only of a change of note, but doesn't have absolute pitch.

1035. When one fails to recognize the Mediterranean on the map with a different colouring, *that* does not shew that there is *really* a different visual object before one. (Köhler's example.†1) At most that might give a plausible ground for a particular *way of expressing oneself*. For it is not the same to say "That shews that here there are two ways of seeing"--and "Under these circumstances it would be better to speak of 'two different objects of sight'."

1036. That an aspect can be summoned up by thoughts is extremely important, although it doesn't solve the problem.

It is as if the aspect were an inarticulate reverberation of a thought.

1037. I hear two people talking, don't understand what they are saying but hear the word "bank". Now I take it for granted that they are talking about money. (This may turn out right or wrong.) Does that mean that I *heard* the word "bank" in *that* meaning?

On the other hand: someone is speaking in a kind of game, uttering words of double meaning out of any context; I hear the word "bank" and hear it in that meaning. It is almost as if this last were a worthless vestige of the first proceeding.

1038. Why shouldn't the overwhelming inclination exist, to use a certain word in our utterance? And why shouldn't this word, nevertheless, be misleading, when we are reflecting on our experience?

I mean: Why should we not want to say "see" although the comparison with seeing is in many ways wrong? Why should we not be impressed by an analogy, to the detriment of all the differences? But for that reason one can't appeal to the words of the utterance.

Physiological consideration here is merely confusing. Because it distracts us from the logical, conceptual problem.

1039. The confusion in psychology is not to be explained by its being a "young science". Its state isn't at all to be compared with, e.g., that of physics in its early period. Rather with that of certain branches of mathematics. (Set theory.) For there exists on the one hand a certain experimental method, and the other hand conceptual confusion; as in some parts of mathematics there is conceptual confusion and methods of proof. While, however, in mathematics one may be pretty sure that a proof will be important, even if it is not yet rightly understood, in psychology one is completely uncertain of the fruitfulness of the experiments. Rather, in psychology there is what is problematic and there are experiments which are regarded as methods of solving the problems, even though they quite by-pass the thing that is worrying us. [Cf. P.I. p. 232.]

1040. One might get tempted to believe that there was a particular kind of way in which one pronounces dates, a particular cadence or something of that sort. For to me a number like 1854, say the number

of a house, may have something date-like about it. One might believe that our experience is that of a particular mental adjustment, which makes the mind ready for a particular activity; and so it is to be compared to the posture of the body before jumping. This is a very enticing error. It is a fact of experience that *this* posture is a frequent or appropriate preparation for *this* activity. But we did not learn that this feeling, this experience, is a serviceable preparation for such-and-such an application of the figure, the number, etc. Expressions like "It is as if the

experience were already a-quiver with the future application", "It is as if we were already innervating the muscles for this particular activity," etc. etc. are only paraphrased *expressions* of the experience. (As if someone were to say "My heart is glowing with love for...".) Here, moreover, we have an indication of the origin of the sensation of innervation which is supposed to constitute the consciousness of the act of will.

Page 181

1041. As I recognize someone I say: "Now I see--the features are the same, only..." and there follows a description of the changes that are in fact there. Suppose I said "The face is rounder than it was"--am I to say it is some peculiarity of the optical picture, of the visual impression, that shews me this? Of course it will be said: "No, here an optical picture comes together with a memory." But how do these two things come together? Isn't it *as if* two pictures were getting compared here? But there aren't two pictures being compared; and if there were, one would still have to keep on recognizing one of them as the picture of the earlier face.

Page 181

1042. I may, however, say: I see that this figure is contained in that one, but I can't *see* it in it. This description is a proper one for this figure, but still I can't *see* the figure according to the description.



And here "seeing" doesn't mean "recognizing in a flash" either. For it might well be that someone was unable to see the one figure in the other at first glance, but that he could do this *after* he had, as it were piecemeal, recognized the containment of the one by the other.

Page 181

1043. If I use the two pictures to inform him that the one figure is contained in the other, or that I recognize that it is so, I don't thereby inform him that I see the one in the other. Wherein resides the difference between the two pieces of information? (Their verbal expression need not differ.)

Page Break 182

Page 182

1044. I cannot see the figure  as a union of  and  which are pushed together in such a way that they are half super-imposed, so that the middle black region as it were counts as doubled. If now someone said he could see the figure this way could I not understand this? Could I believe it? Should I say that this is possible--even if nothing of the kind has ever happened to me? Need I say "You just mean something different by 'seeing this way' from what I mean by it"? And if I did accept it, what should I now know, what could I do with it? (A physiological application is of course again imaginable.)

Page 182

1045. Here belongs the question "What information would anyone be giving me, who said that he could *see* a regular 50-gon as such? How would one test his statement? What allow to count as a test?"

Page 182

It seems to me possible that one would accept *nothing at all* as confirmation of this statement.

Page 182

1046. "For me it is *this* ornament now." The "this" must be explained by indicating a *class* of ornaments. One may perhaps say "There are white stripes on something black". No, there isn't any other account of it to give. Although one would like to say: "There must surely be a simpler expression of what I am seeing!" And perhaps there is too. For in the first place one might use the expression "to stand out". One can say "These parts stand out". And now, can't one imagine a primitive reaction of a human being, who did not use words to express this, but rather indicated the parts that "stand out" with his finger, and a special gesture. But that would not make this primitive expression *equivalent* to the verbal expression "white-stripe-ornament".

Page 182

1047. But this too would be possible: a great collection of expressions, of concepts, might be quite equivalent in meaning for someone in this case. And if *that* were the case, ought one to say that the described aspect is purely optical?

Page 182

1048. The question is, however: why the primitive reaction of pointing with the finger is to be called an expression of seeing-as. One will surely not be able to call it so without more ado. Only when it is combined with other expressions.

Page 182

1049. Imagine someone always used a memory to express seeing-as. That he said, e.g., that the figure reminded him now of this now of

Page Break 183

that, which he once saw. What could I do with *this* information?

Can something remind me of this object for half-an-hour together?--supposing I am not occupying myself with this memory.

1050. If now the situation is that, while there is such a thing as an experience of meaning, this after all is something incidental, how in that case can it seem so very important? Does that come of the fact that this phenomenon accommodates a certain primitive interpretation of our grammar (the logic of our language)? Just as one often imagines that the memory of an event must be an internal picture--and such a picture does sometimes really exist.

1051. However blurred my visual picture, it must surely have a *determinate blurredness*, so it must after all be a determinate picture. That presumably means it must be capable of having a description that fits it exactly; the description would then first have to have the same vagueness as the thing described.--But now cast a glance at the picture and give a description that in this sense fits exactly. This description ought properly to have been a *picture*, a drawing! But here what is in question just isn't a blurred copy of a blurred picture. What we see is unclear in a quite different sense. And I believe that the desire to speak of a private visual object might fade for someone, if he thought oftener about this visual scene. The thing is: the method of projection which is possible elsewhere is not possible here.

1052. When I say "He sat on a bank in the grounds", of course one finds it difficult to think of a money-bank here, or to imagine one; but that doesn't prove that one would otherwise have imagined a different bank.

It might, e.g., come easy to us in talking to draw certain pictures corresponding to our talk, and it might be very difficult to draw pictures that conflicted with the intention or the context of what we said. But that wouldn't prove that we always draw while we talk.

1053. If, as I consider this question, I now pronounce all by itself the sentence "You must put the money in the bank", and I mean it in such-and-such a way--does that mean that the same thing is going on in me when I pronounce the sentence as when I say the sentence with this meaning to someone on a real occasion? What might justify such an assumption? At most, that I then say "Just now I meant the

word... in the meaning...". And here the question surely is one of a kind of optical illusion! What justifies that observation in practice is certainly not a process that accompanies the speaking. Even though there may be processes accompanying speech, which point towards this meaning. (The direction of my glance, for example.)

1054. The difficulty is to know one's way about among the concepts of 'psychological phenomena'.

To move about among them without repeatedly running up against an obstacle.

That is to say: one has got to *master* the kinships and differences of the concepts. As someone is master of the transition from any key to any other one, modulates from one to the other.

1055. "Just now I spoke the word... in the meaning...".--How do you know you did? Suppose you've made a mistake? How did you learn to speak it in *that* meaning?

If anyone says "Just now I spoke the word in isolation in *that* meaning", he is playing a totally different language-game from someone who tells me he meant *this* by this word in that report or order.

And so now it is either essential, or inessential, that he also uses the word "to mean" in the first case. If it is essential, then this first language-game is a reflection of the second one.

Say, as a chess-game on the stage may be called a reflection of a real chess-game.

1056. Playing mental chess with someone else: both parties play in the imagination and agree that *this* player won, this one has lost. They are then both able to reproduce the game from memory, agreeing with one another; they can write it down or narrate it.--Think of tennis played like that. It would be possible. Only of course it wouldn't be any sort of muscular exercise. (Although even that might be imagined.)--It is important that even with 'tennis in the imagination' one will be able to say "*I succeeded in... the ball*".

1057. I might dream of a game of chess; but perhaps the dream only shewed me a single move of the game. Nevertheless I would have dreamt: that I played a game of chess. In that case it will be said: "You didn't really play it. You dreamt it." Why shouldn't it also be said "You didn't really mean the word that way, you only dreamt it"?

1058. In a law-court, e.g., the question might be gone into how someone meant a word, and it may also be inferred from certain facts that he meant it this way. It is a question of intention; but could that other case of *meaning* something, where I dreamt of meaning it, have the same importance? [Cf. P.I. p. 214e.]

1059. But how about this: when I read a poem, or some expressive prose, especially when I read it out loud, surely there is something going on as I read it which doesn't go on when I glance over the sentences only for the sake of their information. I may, for example, read a sentence with more intensity or with less. I take trouble to get the tone exactly right. Here I often see a picture before me, as it were an illustration. And may I not also utter a word in such a tone as to make its meaning stand out like a picture? A way of writing might be imagined, in which some signs were replaced by pictures and so were made prominent. This does actually happen sometimes, when we underline a word or positively put it on a pedestal in the sentence. (("... there lay a something....")) [Cf. P.I. p. 214g.]

1060. When I am reading expressively and I pronounce this word, it is, so to speak, filled brimful with its meaning. And now it might be asked "How *can* that be?" [Cf. P.I. p. 215a.]

1061. "How can that be, if meaning is what you believe?" The use of a word can't accompany it or fill it brimful. And now I may reply: my expression was picturesque.--But the picture *forced* itself *on me*. *I want to say*: the word was filled with its meaning. There might perhaps be some explanation of how it comes about that I want to say that.

But why, then, am I not supposed to '*want to say*': I pronounced the (isolated) word with *this* meaning? [Cf. P.I. p. 215a.]

1062. Why shouldn't a particular technique of employment of the words "meaning", "to mean" and others lead me to use these words in, so to speak, a picturesque, improper, sense? (As when I say that the sound *e* is yellow.) But I don't mean: it is a *mistake*--I didn't *really* pronounce the word in this meaning, I only imagined I did. That's not how it is. For I don't merely imagine, either, that there is a game of chess in "Nathan". †1

1063. Thinking in terms of physiological processes is extremely dangerous in connexion with the clarification of conceptual problems in psychology. Thinking in physiological hypotheses deludes us sometimes with false difficulties, sometimes with false solutions. The best prophylactic against this is the thought that I don't know at all whether the humans I am acquainted with actually have a nervous system.

1064. The case of 'meaning experienced' is *related* to that of seeing a figure as this or that. We have to describe this conceptual relationship; we are not saying that the same thing is under consideration in both cases.

1065. When you write your F like this:  do you mean it as a 'slipped' F or as a mirror F? Do you *mean* it to look to the right or the left?--The second question *obviously* does not refer to a process that accompanies the writing. With the first question, one *might* be thinking of such a process.

1066. "I see that the child wants to touch the dog, but doesn't dare." How can I see that?--Is this description of what is seen on the same level as a description of moving shapes and colours? Is an interpretation in question? Well, remember that you may also *mimic* a human being who would like to touch something, but doesn't dare. And what you mimic is after all a piece of behaviour. But you will perhaps be able to give a *characteristic* imitation of this behaviour only in a wider context.

1067. One will also be able to say: What this description says will get its expression somehow in the movement and the rest of the behaviour of the child, but also in the spatial and temporal surrounding.

1068. But now am I to say that I really 'see' the fearfulness in this behaviour--or that I really 'see' the facial expression? Why not? But that is not to deny the difference between two concepts of what is perceived. A picture of the face might reproduce its features very accurately, but not get the expression right; it might, however, be right as far as the expression goes and not hit the features off well. "Similar expression" takes faces together in a quite

different way from "similar anatomy".

Page 186

1069. Naturally the question isn't: "Is it right to say 'I see his sly wink'." What should be right or wrong about that, beyond the use of

Page Break 187

the English language? Nor are we going to say "The naïf person is quite right to say he *saw* the facial expression"!

Page 187

1070. On the other hand one would like to say: We surely can't 'see' the expression, the shy behaviour, *in the same sense* as we see movement, shapes and colours. What is there in this? (Naturally, the question is not to be answered physiologically.) Well, one does say, that one sees both the dog's movement and its joy. If one shuts one's eyes one can see neither the one nor the other. But if one says of someone who could accurately reproduce the movement of the dog in some fashion in pictures, that he saw all there was to see, he would not have to recognize the dog's joy. So if the ideal representation of what is seen is the photographically (metrically) exact reproduction in a picture, then one might want to say: "I see the movement, and somehow *notice* the joy."

But remember the meaning in which we learn to use the word "see". We certainly say we see this human being, this flower, while our optical picture--the colours and shapes--is continually altering, and within the widest limits at that. Now that just is how we do use the word "see". (Don't think you can find a better use for it--a phenomenological [[sic]] one!)

Page 187

1071. Now do I learn the meaning of the word "sad"--as applied to a face--in just the same way as the meaning of "round" or "red"? No, not in quite the same way, but still in a similar way. (I do also react differently to a face's sadness, and to its redness.)

Page 187

1072. Look at a photograph: ask yourself whether you see only the distribution of darker and lighter patches, or the facial expression as well. Ask yourself what you see: how would it be easier to represent it: by a description of that distribution of patches, or by the description of a human head; and when you say of the face that it is smiling--is it easier to describe the corresponding lie and shape of the parts of the face, or to smile yourself?

Page 187

1073. "What I *see* can't be the expression, because the recognition of the expression depends on my knowledge, on my general acquaintance with human behaviour." But isn't this merely an historical observation?

Page Break 188

Page 188

1074. Is it here as if I were perceiving a 'fourth dimension'? Well, yes and no. Queer, however, it is *not*. From which you ought to learn that what strikes someone as queer when he is philosophizing is not queer. We make the assumption: the word... would really have to be used like *this* (*this* use strikes us as a prototype) and then we find the normal use extremely queer.

Page 188

1075. "What I properly see must surely be what is produced in me by influence of the object"--In that case what is produced in me is something like a copy, something that one can oneself in turn *look at*, have before him. Almost something like a *materialization*.

And this materialization is something spatial and must be describable in its entirety by the use of spatial concepts. Then, while it may smile, the concept of friendliness has no part in the representation of it, but is rather *alien* to this representation (even though this concept may subserve this representation.). [Cf. P.I. p. 199g.]

Page 188

1076. If someone were capable of making an exact copy of this portrait--should I *not* say he saw everything that I did? And he wouldn't have to allude to the head as a head or as something three-dimensional, at all; and even if he does, the expression need not say anything to him. And if it does speak to me--should I say I see more than the other?

I might say so.

Page 188

1077. But a painter can paint an eye so that it stares; so its staring must be describable by the distribution of colour on the surface. But the one who paints it need not be able to describe this distribution.

Page 188

1078. Understanding a piece of music--understanding a sentence.

I am said not to understand a form of speech like a native if, while I do know its sense, I yet don't know, e.g.,

what class of people would employ it. In such a case one says that I am not acquainted with the precise shade of meaning. But if one were now to think that one has a different sensation in pronouncing the word if one knows this shade of meaning, this would again be incorrect. But there are, e.g., innumerable transitions which I can make and the other can't.

Page 188

1079. But one would like to say: "Human mental life can't be described at all; it is so uncommonly complicated and full of scarcely graspable experiences. In great part it is like a brewing of coloured

Page Break 189

clouds, in which any shape is only a transition to other shapes, to other transitions.--Why, take just visual experience! Your gaze wanders almost incessantly, how could you describe it?"--And yet I do describe it!--"But that is only a quite crude description, it gives only the coarsest features of your experience."--But isn't this just what I *call* description of my experience? How then do I arrive at the concept of a kind of description that I cannot possibly give?

Page 189

1080. Imagine looking at flowing water. The picture presented by the surface keeps on changing. Lights and darks everywhere appear and disappear. What would I call an 'exact description' of this visual picture? There's nothing I would call that. If someone says it can't be described, one can reply: You don't know what it would be right to call a description. For you would not acknowledge the most exact photograph as an *exact* representation of your experience. There is no such thing as exactness in this language-game. (As, that is, there is no knight in draughts.)

Page 189

1081. The description of the experience doesn't describe an object. It may subserve a description. And this object is sometimes the one that one is looking at, and sometimes (photography) not.

The impression--one would like to say--is not an object.

Page 189

1082. We learn to describe objects, and thereby, in another sense, our sensations.

Page 189

1083. I look into the eye-piece of an instrument and draw or paint a picture of what I see. Whoever looks at it can say: "So *that's* how it looks"--but also "So *that's* how it looks to you".

I might call the picture a description of what I was looking at, but also a description of my visual impression.

Page 189

1084. "The impression is blurred"--'so the object in my consciousness is blurred'.

Page 189

1085. One can't look at the impression, that is why it is not an object. (Grammatically.) For one doesn't look at the object to alter it. (That is really what people mean when they say that objects exist 'independently of us'.) [Cf. Z 427.]

Page Break 190

Page 190

1086. "The chair is the same, whether I am looking at it or not!"--that *need* not have been so. Humans are often embarrassed when one looks at them. "The chair goes on existing whether I am looking at it or not." That might be an empirical proposition, or it might be one to take grammatically. But in saying it one may also be thinking simply of the conceptual difference between sense-impression and object. [Cf. Z 427.]

Page 190

1087. German nouns printed in lower-case letters in certain modern poets. A German noun all in lower-case letters looks alien; to recognize it, one has to read it attentively. It is supposed to strike us as *new*, as if we had seen it now for the first time.--But what interests me here? This--that the impression can't at first be described more exactly than by means of words like 'queer', 'unaccustomed'. Only later follow, so to speak, analyses of the impression. (The reaction of recoil from the strangely written word.)

Page 190

1088. We teach someone the meaning of the word "eerie" by bringing it into connexion with a certain behaviour in certain situations (though the *behaviour* is not called that). In such situations he now says it feels eerie to him; and even that the word "ghost" has something eerie about it.--How far was the word "eerie" to start with the name of a feeling? If someone shrinks back from entering a dark room, why should I call this or the like the expression of a feeling? For "feeling" certainly makes us think of sensation and sense-impression, and these in turn are the objects immediately before our minds. ((I am trying to make a logical step here, one that comes hard to me.))

Page 190

1089. "What do I know of the feelings of others, and what do I *know* of my own?" means that an experience, conceived as an *object*, slips out of view.

Page 190

1090. For can anything be more remarkable than this, that the *rhythm* of a sentence should be important for exact understanding of it?

Page 190

1091. It's as if the one who pronounces the sentence as a piece of information told us something, but as if the sentence too, as a mere *example*, did the same.

Page Break 191

Page 191

1092. Certainly it's clear that the description of impressions has the form of the description of '*external*' objects--with certain deviancies. E.g. a certain vagueness.

Or again: So far as the description of the impression looks the same as the description of an object, it is a description of an object of perception. (Hence consideration of binocular vision ought to be somewhat disquieting for one who speaks of the visual object).

Page 191

1093. "Thinking is an enigmatic process, and we are a long way off from complete understanding of it." And now one starts experimenting. Evidently without realizing *what* it is that makes thinking enigmatic to us.

The experimental method does *something*; its failure to solve the problem is blamed on its still being in its beginnings. It is as if one were to try and determine what matter and spirit are by chemical experiments.

Page 191

1094. Someone who describes his visual impression doesn't describe the edges of the visual field. Is this an incompleteness in our descriptions?

If I shut my left eye and then turn my eyes as far as I can to the right, I still, 'out of the corner of my eye' see an object shining out. I might even give a rough description of this impression. I might also produce a drawing of it, and it would perhaps shew some darkneses and a dark merging border: but only someone who knows in what situation it is to be employed can rightly understand or employ this picture. That is to say: he too might now shut one eye, look as far as possible to the right, and say he has this impression too, or: that his impression deviates from my picture in this way or that.

Page 191

1095. That we *calculate* with some concepts and with others do not, merely shews how different in kind conceptual tools are (how little reason we have ever to assume uniformity here). [Cf. Z 347.]

Page 191

1096. Turing's 'Machines'. These machines are *humans* who calculate. And one might express what he says also in the form of *games*. And the interesting games would be such as brought one *via* certain rules to nonsensical instructions. I am thinking of games like the "racing game". One has received the order "Go on in the same way" when this makes no sense, say because one has got into a circle. For any order makes sense only in certain positions. (Watson.)

Page Break 192

Page 192

1097. A variant of Cantor's diagonal proof: Let $N = F(K, n)$ be the form of the law for the development of decimal fractions. N is the n th decimal place of the K th development. The diagonal law then is: $N = F(n, n) = \text{Def } F'(n)$.

To prove that $F'n$ cannot be one of the rules $F(k, n)$. Assume it is the 100th. Then the formation rule of

$F'(1)$	runs	$F(1, 1)$
of		
$F'(2)$		$F(2, 2)$ etc.

But the rule for the formation of the 100th place of $F'(n)$ will run $F(100, 100)$; that is, it tells us only that the hundredth place is supposed to be equal to itself, and so for $n = 100$ it is *not* a rule.

The rule of the game runs "Do the same as..."--and in the special case it becomes "Do the same as you are doing". [Cf. Z 694.]

Page 192

1098. The concept of 'ordering', e.g., the rational numbers, and of the 'impossibility' of so ordering the irrational numbers. Compare this with what is called an ordering of digits. Likewise the difference between the 'correlation' of a figure (or nut) with another and the 'correlation' of all whole numbers with the even numbers. Everywhere a shifting of concepts. [Cf. Z 707.]

1099. The description of the subjectively seen is closely or distantly related to the description of an object, but does not function like the description of an object. How does one compare visual sensations? How do I compare my visual experiences with someone else's? [Cf. Z 435.]

1100. We don't see the human eye as a receiver; it seems, not to let something in, but to send out. The ear receives; the eye looks. (It casts glances, it flashes, beams, coruscates.) With the eye one may terrify, not with the ear or the nose. When you see the eye, you see something go out from it. You see the glance of the eye. [Cf. Z 222.]

1101. "When you get away from your physiological prejudices, you'll find nothing in the fact that the glance of the eye can be seen." Certainly I too say that I see the glance that you throw someone else. And if someone wanted to correct me and say I don't really *see* it, I should hold this to be a piece of stupidity.

On the other hand I have not *admitted* anything with my way of putting it, and I contradict anyone who tells me I see the eye's glance 'just as' I see its form and colour.

For 'naive language', that's to say our naive, normal, way of expressing ourselves, does not contain any theory of seeing--it shews you, not any theory, but only a *concept* of seeing. [Cf. Z 223.]

1102. And if someone says "I don't really see the eye's glance, but only shapes and colours",--is he contradicting the naive form of expression? Is he saying that the man was going beyond his rights, who said he saw my glance all right, that he saw this man's eye staring, gazing into vacancy, etc? Certainly not. So what was the purist trying to do?

Does he want to say it's more correct to use a different word here instead of 'seeing'? I believe he only wants to draw attention to a division between concepts. For how does the word "see" associate perceptions? I mean: it may associate them as perceptions *with the eye*; for we do *not* feel seeing *in* the eye. But really the one who insists on the *correctness* of our normal way of talking seems to be saying: everything is contained in the visual impression; that the *subjective eye* equally has shape, colour, movement, expression and glance (external direction). That one does not detect the glance, so to speak, *somewhere else*. But that doesn't mean 'elsewhere than in the eye'; it means 'elsewhere than in the visual picture'. But how would it be for it to be otherwise? Perhaps so that I said: "In this eye I see such and such shapes, colours, movements,--that means it's looking friendly at present," i.e. as if I were drawing a conclusion.--So one might say: The place of the *perceived* glance is the *subjective* eye, the visual picture of the eye itself.

1103. First and foremost, I can very well imagine someone who, while he sees a face extremely accurately, and can, e.g., make an accurate portrait of it, yet doesn't recognize its smiling expression as a smile. I should find it absurd to say that his sight was defective. And equally absurd to say that his subjective visual object just wasn't smiling, although it has all the colours and form that mine has.

1104. That is to say: here we are drawing a conceptual boundary (and it has nothing to do with physiological opinions).

1105. High-light or reflection: when a child paints, it will never paint these. Why, it is almost bewildering that they can be represented by means of the usual oil- or water-colours. [Cf. Z 370.]

1106. One who sees that someone is stretching out his hand to touch something, but is afraid of it, does surely in a certain sense see the same as one who can imitate the movements of the hand down to the last detail, or can represent it by means of drawings, but has not the power of interpreting it in that way.

1107. If someone says: Obviously (to any unprejudiced person) the shape, the colour, the organization, the expression, are properties of the subjectively seen, of the immediate object of sight--here the word 'obviously' betrays him. The reason why it is obvious is: because everyone admits it; and admits it only through the use of language. So here one is using a *picture* to give a reason for a proposition.

†1 If someone says: The shape, the colour, the organization, the expression, are surely all *obviously* properties of the immediately seen (of my object of sight)--he is basing his opinion on a *picture*.--For, if someone

admits that each of those things is a property of his immediate object of sight--what information is he giving us? If he, e.g., tells someone else: "It's like that for me too"--what conclusion can I draw from this? (What if this full agreement were based on a misunderstanding?)

Page 194

1108. That picture is nothing but an *illustration* contributing to the methodology of our language. If we are really all inclined to find this picture apt, this is perhaps of psychological interest, but it is no substitute for a conceptual investigation.

Page 194

1109. There are *two* things one may call "Methodology": A description of the activities that are, e.g., called "measuring", a branch of human natural history, which is going to make the concepts of measuring, of exactness etc., intelligible to us in their variations; or on the other hand a branch of applied physics, the theory of how best (most accurately, most conveniently) to measure this or that under such-and-such circumstances. [Cf. P.I. p. 225.]

Page 194

1110. I tell him: "Change the way you are adjusted like this:..."--he does so; and now *something* is altered in him. 'Something'? His attitude is altered; and one can describe the alteration. Calling the attitude 'something in him' is misleading. It is as if we could now dimly see, or feel, a Something, which has altered and which is called "the attitude". Whereas everything lies open to the light of day--but the words "a new attitude" do not designate a sensation.

Page Break 195

Page 195

1111. What does the description of an 'attitude' look like?

One says, e.g., "Look away from these little spots and this small irregularity, and regard it as a picture of a ...".

"Think that away! Would it be unacceptable to you even without this...?" I shall be said to be altering my visual picture--as I do by blinking or keeping a detail out of view. This "Looking away from..." plays a role quite like that of the construction of a new picture. [Cf. Z 204.]

Page 195

1112. Very well,--and these are good reasons to say that through our attitude we made a change in our visual impression. That is to say, these are good reasons for delimiting the concept 'visual impression' in this way. [Cf. Z 205.]

Page 195

1113. The word "organization" fits in very well with the concept 'belonging together'. There seems to be a series of simple modifications of the visual impression here, which are all really 'optical'. With different aspects, however, one may do other quite different things besides separating parts and taking them together, or suppressing some and making others prominent.

Page 195

1114. I may, however, *call* "taking together" some definite thing, a definite peculiarity of the process of copying a drawing. I may then say that in reproduction by drawing, or in description, someone takes the figure together like *this*, organizes it like this. (Of course there'd be difficulties about that in some cases, e.g. in the case of the duck-rabbit.)

Page 195

1115. Now one says: I can take lines together in copying, but I can also do so by means of *attention*. Like the way I can calculate in my head, as on paper.

Page 195

1116. Can Gestalt psychology classify the different organizations that can be introduced into the unorganized visual picture; can it give once for all the possible *kinds* of modification which the plasticity of our nervous system can elicit? When I see the dot as an eye which is looking in *this* direction--what system of modifications does that fit into? (System of shapes and colours.)

Page Break 196

Page 196

1117. E.g., it is, I believe, misleading when Köhler†1 describes the spontaneous aspects of the figure

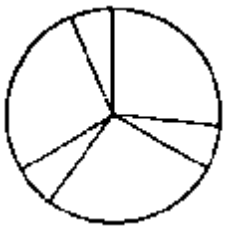

by saying: the lines which belong to the same arm in one aspect, now belong to different arms. That sounds as if what were in question here were again a way of taking these radii together. Whereas, after all, the radii that belonged together before belong together now as well; only one time they bound an 'arm', another time an intervening space.

Page 196

1118. Indeed, you may well say: what belongs to the description of what you see, of your visual impression, is not merely what the copy shews but also the claim, e.g., to see this "solid", this other 'as intervening space'. Here it all depends on *what we want to know* when we ask someone what he sees.

Page 196

1119. "But surely it's obvious that in seeing I can *take* elements *together* (lines, for example)?" But why does one call it "taking together"? Why does one here need a word--*essentially*--that already has another meaning? (Naturally it is the same here as in the case of the phrase "*calculating* in the head.") [Cf. Z 206.]

Page 196

1120. When I tell someone "Take these lines (or something else) together", what will he do? Well, a variety of things according to the circumstances. Perhaps he is to count them two by two, or put them in a drawer, or look at them etc. [Cf. Z 207.]

Page 196

1121. Is the drawing that you see itself organized? And when you 'organize' it in such-and-such a way, do you then see more than is present?

Page 196

1122. "Organize these things." What does this mean? Perhaps "arrange them". It might mean "give them some order",--or again: learn to know your way about among them, learn to describe them; learn to describe them by means of a system, by means of a rule.

Page 196

1123. Once more, the question is: What information do I give someone with the words "In looking, I am now taking the lines together like *this*"? This question may also be put like this: For what purpose do I tell someone "In looking, take these lines together like *this*"?--There is here again a similarity to the demand "Imagine *this*".

Page Break 197

Page 197

1124. The egg-shell of its origin clings to any thinking, shewing one *what* you struggled with in growing up. What views are your circle's testimony: from which ones you have had to break free.

Page 197

1125. The picture  does not organize itself under our gaze.

Page 197

1126. It is perhaps important to remember that I may see, take, a figure this way today, and differently tomorrow, without there needing to have been a 'jump'. I might, for example, take and use an illustration in a book in *this* way today, and tomorrow encounter the same illustration on a later page where it is to be taken differently, without noticing that it is the same figure again.

Page 197

1127. Could a man demonstrate his reliability by saying: "It is true; and see! I believe it."

Page 197

1128. Might it be said: a way of taking something, a technique, is mirrored in an experience? Which, after all, only means: we employ the expression that we have learnt for a technique in an expression of experience (*not*: as *designation* of an experience).

Page 197

1129. Well, why should a way of speaking not be responsible for an experience?

Page 197

1130. Would it make sense to ask a composer whether one should hear a figure like *this* or like *this*; if that doesn't

also mean: whether one should *play* it in this way or that?

Page 197

1131. Memory: "I still see us sitting at that table."--But have I really the same visual picture--or one of those which I had then? Do I also certainly see the table and my friend from the same point of view as then, and so not see myself?--My memory image is not evidence of that past situation; as a photograph would be, which, having been taken then, now bears witness to me that this is how it was then. The memory image and the memory words are on the *same* level. [Cf. Z 650.]

Page 197

1132. Why shouldn't it be that one excludes mutually contradictory conclusions: not because they are contradictory, but because they are useless? Or put it like this: one need not shy away from them as from something unclean, because they are contradictory: let them be excluded because they are no use for anything.

Page Break 198

Page 198

1133. You must seriously imagine that there really could be a word in some language that stood for pain-behaviour and *not* for pain.

Page 198

1134. He asks "What did you mean when you said...?" I answer the question and then I add: "If you had asked me before, I'd have answered the same; my answer was not an *interpretation* which had just occurred to me." So had it occurred to me earlier? No.--And how was I able to say then: "If you had asked me earlier, I'd have..."? What did I infer it from? From nothing at all. What do I tell him, when I utter the conditional. Something that may sometimes be of importance.

Page 198

1135. He knows, for example, that I haven't changed my mind. It also makes a difference whether I reply that I was 'only saying these words to myself' without meaning anything by them; or, that I meant this or that by them. Much depends on this.

Moreover, it makes a difference whether someone says to me "I love her" because the words of a poem are going through his head or because he is saying it to make a confession to me of his love.

Page 198

1136. Is it not peculiar, however, that there is such a thing as this reaction, as such a confession of intention? Isn't it an extremely remarkable linguistic instrument? What is really remarkable about it? Well--it is difficult to imagine how a human learns this use of words. It is so entirely subtle. [Cf. Z 39.]

Page 198

1137. But is it really more subtle than that of the words "I formed an image of him" for example? Yes, any such use of language is remarkable, peculiar, when one is adjusted only to consider the description of physical objects. [Cf. Z 40.]

FOOTNOTES

Page 11

†1 The words in brackets are in English. (*Eds.*)

Page 13

†1 These words occur in English. (*Eds.*)

Page 15

†1 These paragraphs are alternatives.

Page 17

†1 The reference is to the opera singer who had to sing 'Weiche, Wotan, weiche' ('Depart Wotan, depart') and to whom the other singer on the stage had just whispered 'Do you like your eggs soft (*weiche*) or hard?' (*Eds.*)

Page 19

†1 The passage (between asterisks) occurs in English, not German. (*Eds.*)

Page 24

†1 As in the fairy tale "The Man who could not Shudder." See Grimm's *Fairy Tales*.

Page 32

†1 The MS has "That is a rule". (*Eds.*)

Page 43

†1 These words occur in English. (*Eds.*)

Page 51

- †1 Schumann: *Davidsbündlertänze*. *Eds.*
Page 52
- †1 Quoted in English. *Trans.*
Page 62
- †1 *Philosophical Investigations* I, 15 and 26. (*Eds.*)
Page 64
- †1 "not a thing" also in the German text. (*Eds.*)
Page 74
- †1 I have substituted Marlowe's line for Wittgenstein's example from Goethe, *Faust*, Part II. V. (*Trans.*)
Page 90
- †1 The words in brackets occur in English. (*Eds.*)
Page 94
- †1 "If God held enclosed in his right hand all truth, and in his left simply the unremitting impulse towards truth, although with the condition that I should eternally err, and said to me 'Choose!' I should humbly fall before his left hand, and say: 'Father, give! Pure truth is for thee alone!'"
Page 105
- †1 See P.I. Part I, §2. (*Eds.*)
Page 116
- †1 "*Forms of life*" was a variant here. *Trans.*
Page 119
- †1 In German all nouns are masculine, feminine or neuter. *Trans.*
Page 129
- †1 J. P. Hebel: *Schatzkästlein, Zwei Erzählungen*. (*Eds.*)
Page 132
- †1 The last sentence in English. (*Eds.*)
Page 133
- †1 "Perpetual cloud descends". Spoken by Care in Goethe's *Faust*, Part II, Act v.
Page 148
- †1 This passage presents severe problems of translation, because quite ordinary German has two words, "Erlebnis" and "Erfahrung," both of which are regularly translated 'experience'. I was not willing either simply to use the German words or to say, e.g. 'experience'₁ and 'experience'₂. I have therefore kept 'experience' for 'Erlebnis' and used 'undergoing' for 'Erfahrung'. I apologize for the air of philosophical technicality and the unnaturalness that is forced upon me by having to find two words where common or garden English has only one. *Trans.*
Page 151
- †1 "Descent of permanent cloud." Goethe, *Faust*, II. V.
Page 152
- †1 The reference is to the figure known among English psychologists as the 'duck-rabbit.' See *Philosophical Investigations* II, xi. (*Eds.*)
Page 153
- †1 These three words are in English. (*Eds.*)
Page 170
- †1 *Gestalt Psychology*, New York, 1929, p. 198. (*Eds.*)
Page 172
- †1 *Gestalt Psychology*, p. 200f. (*Eds.*)
Page 179
- †1 Köhler, *Gestalt Psychology*, p. 195ff. (*Eds.*)
Page 185
- †1 Lessing, *Nathan the Wise*. (*Eds.*)
Page 194
- †1 Marked as an alternative version in the MS. (*Eds.*)
Page 196
- †1 Op. cit. p. 185. (*Eds.*)

REMARKS ON THE PHILOSOPHY OF PSYCHOLOGY

Volume II

Page i

Page Break ii

Titlepage

Page ii

Ludwig Wittgenstein:

REMARKS ON THE PHILOSOPHY OF PSYCHOLOGY:

VOLUME II

Edited by

G. H. VON WRIGHT

and

HEIKKI NYMAN

Translated by

C. G. LUCKHARDT *and* M. A. E. AUE

BASIL BLACKWELL
OXFORD

Page Break iii

Copyright page

Page iii

Copyright © Blackwell Publishers Ltd, 1980

First published in 1980

Reprinted 1988, 1990, 1998

Blackwell Publishers Ltd
108 Cowley Road
Oxford OX4 1JF, UK

All rights reserved. Except for the quotation of short passages for the purposes of criticism and review, no part of this publication may be reproduced, stored in a retrieval system, or transmitted, in any form or by any means, electronic, mechanical, photocopying, recording or otherwise, without the prior permission of the publisher.

Page iii

Except in the United States of America, this book is sold subject to the condition that it shall not, by way of trade or otherwise, be lent, resold, hired out, or otherwise circulated without the publisher's prior consent in any form of binding or cover other than that in which it is published and without a similar condition including this condition being imposed on the subsequent purchaser.

British Library Cataloguing in Publication Data

Wittgenstein, Ludwig

Remarks on the philosophy of psychology

Vol. 2

1. Cognition 2. Knowledge, Theory of

I. Title II. Wright, Georg Henrik von

III. Nyman, Heikki

153.4 BF311

ISBN 0-631-13062-4

Printed in Great Britain by Athenaeum Press Ltd, Gateshead, Tyne & Wear

PREFACE

The source of this second volume of *Remarks on the Philosophy of Psychology* is TS No. 232. Wittgenstein probably dictated it in September or October 1948. The remarks underlying this dictation stem from the period 19 November 1947 to 25 August 1948, MSS 135-137. The places in the text that were faulty or obscure we have tried to amend by an exact collation with the MS sources. During this task we received valuable suggestions from the translators of the German text into English, C. G. Luckhardt and M. A. E. Aue. We thank them for their readiness to help us.

Helsinki

Georg Henrik von Wright

Heikki Nyman

TRANSLATORS' NOTE

We have followed two principles in translating this material. First, since the text contains many passages already translated in *Zettel*, and a few passages from Part II of the *Investigations*, we had to decide between preparing an entirely new translation of these remarks, and following Professor Anscombe's translations as closely as possible. Since our translation would not differ significantly from hers, and because any minor stylistic differences might produce confusion, we decided upon the latter course. Few of these parallel passages are absolutely identical, however, and so almost all deviations from Professor Anscombe's translations should be taken as reflecting differences in the German texts.

Second, we have tried to preserve Wittgenstein's highly individual style of writing. For example, the quite large number of both ordinary dashes and specially long dashes, and the different uses to which Wittgenstein puts them, contribute to the vividness of his writing, as does the unusual practice of following a hypothetical subjunctive with a statement in the past tense. ("Suppose that someone were to.... Now did he...?", for example.) These we have retained. Another facet of Wittgenstein's writing which cannot fail to strike the German reader is his choice of words. Most of his verbs are very ordinary ones, and so we have "put into", for example, rather than "infuse". Likewise there is a noticeable lack of philosophical jargon in the text, and so "value judgment" is deliberately used, not "normative judgment". The German text is laced with Anglicisms, Austrianisms, and colloquialisms, and we have tried to retain the flavour of these in the translation.

We wish to express our thanks to Professor G. E. M. Anscombe for her time and diligence in going over our translation with us, and to the American Philosophical Society, whose generous travel grant made a visit to her possible. Also, we wish to thank Dean Glenn Thomas and the Dean's Advisory Committee on Research, of Georgia State University, for the release time and a travel grant which enabled us to complete the translation, and the University Research Committee of Emory University for its travel support.

C. G. Luckhardt
Georgia State University

Maximilian A. E. Aue
Emory University

II

1. 'Surprise' and the *sensation* of suddenly catching one's breath.

2. "I strongly hope...", as opposed to "I hope you'll come". This means approximately the same as "Surely you'll come!"

3. Surely one doesn't normally say "I wish..." on grounds of self-observation, for this is merely an expression of a wish. Nevertheless, you can sometimes perceive or discover a wish by observing your own reactions. If you now ask

me, "Do you recognize the *same thing* in such a case as you express by the *utterance* in the other case?", then there is already a mistake in the question. (As if someone asked, "Is the chair I can see the same as the chair on which I can sit?")

Page 2

4. I say "I hope you'll come", but not "I believe I hope you'll come", but we may well say: "I believe I still hope he'll come." [Zettel 79: henceforth Z will stand for Zettel.]

Page 2

5. "But doesn't one *experience* meaning?" "But doesn't one hear the piano?" Each of these questions can be meant, i.e., used, factually or conceptually. (Temporally, or timelessly.)

Page 2

6. He says "I want to go out now", then suddenly says "No", and does something else. As he said "No", it suddenly occurred to him that he wanted first of all to...--He said "No", but did he also *think* "No"? Didn't he just think about that other thing? One can say he was thinking about it. But to do that he didn't have to pronounce a thought, either silently or out loud. To be sure, he could later clothe the intention in a sentence. When his intentions changed maybe a picture was in his mind, or he didn't just say "No", but some *one* word, the equivalent of a picture. For example, if he wanted to close the closet then maybe he said "The closet!"; if he wanted to wash his hands he might have looked at them and made a face. "But is that thinking?"--I don't know. Don't we say in such cases that someone has "thought something over", has "changed his mind"?

Page Break 3

Page 3

But is it absolutely necessary that he gain the command of a language for *this* kind of thinking? Couldn't an "intelligent" beast act this way? It has been trained to fetch an object from one place and take it to another. Now it starts walking toward the goal without the object, suddenly turns around (*as if it had said* "Oh, I forgot...!") and fetches the object, etc. If we were to see something like this we would say that at that time something had happened within it, in its mind. What then has happened within *me* when I act this way? "Not much at all," I would like to say. And what happens inside is no more important than what can happen outside, through speaking, drawing etc. ((From which you can learn how the word "thinking" is used.))

Page 3

7. Now imagine that someone has to construct something with blocks, or 'Meccano'. He tries out different pieces, tries to combine them, maybe even makes a sketch, etc., etc. Now one says that he *has been thinking* during this activity!--To be sure, in saying this one distinguishes this action from another of a very different sort. But is it a good description of this difference to say that in the one case something else accompanies the manual activity? Could one isolate this something else, perhaps, and make it occur without the other activity?

It isn't true that thinking is a kind of speaking, as I once said. †1 The concept 'thinking' is categorically different from the concept 'speaking'. But of course thinking is neither an accompaniment of speaking nor of any other process.

This means that it is impossible to have the "thought-process", for example, proceed unaccompanied. Nor does it have divisions which correspond to the divisions of other activities (speaking, for example). That is, when we do speak of a "thought-process" it is something like operating (in writing or orally) with signs. Inferring or calculating might be called a "thought-process".

Page 3

8. Likewise it wouldn't be completely wrong to call speaking "the instrument of thinking". But one can't say that the process of speaking is an instrument of the process of thinking, or that language is, as it were, the carrier of thought, as, for example, the notes of a song might be called the carriers of the words.

Page 3

9. The word "thinking" can be used to signify, roughly speaking, a talking for a purpose, i.e., a speaking or writing, a speaking in the imagination, a "speaking in the head", as it were.

Page Break 4

Page 4

10. We say, "Think about what you want to say before you speak". *One* way of doing this is to recite one's speech softly to oneself, or to write it down and make corrections. For instance, one might recite a sentence, shake his head, say "That is too long", etc., and then restate the sentence in another form.

Page 4

11. What thinking is might be described by describing the difference between someone feeble-minded and a normal

child who is beginning to think. If one wanted to indicate the activity which the normal person learns and which the feeble-minded cannot learn, one couldn't derive it from their behaviour.

Page 4

12. The word "thinking" is used in a certain way very differently from, for example, "to be in pain", "to be sad", etc.: we don't say "I think" as the expression of a mental state. At most we say "I'm thinking". "Leave me alone, I'm thinking about..." And of course one doesn't mean by this: "Leave me alone, I am now behaving in such and such a way." Therefore 'thinking' is not behaviour.

Page 4

13. "I thought: 'this stick is too long, I must try another one'." While thinking that maybe I said nothing at all to myself, maybe one or two words. And yet this report is not untrue (or at any rate it may be true). It has a use. We say, for example, "Yes, I watched you and I thought that you were thinking that".

Page 4

14. "Man thinks, feels, wishes, believes, intends, wants, knows." That sounds like a reasonable sentence, just like "Man draws, paints, models", or "Man is acquainted with string instruments, wind instruments,...". The first sentence is an enumeration of all those things man does with his mind. But just as one could add: "And isn't man also acquainted with instruments made from squealing mice?" to the sentence about the instruments--and the answer would be "No"--so there must be added to the enumeration of the mental activities a question of this kind: "And can't men also...?"

Page 4

15. Someone says: "Man hopes." How should this phenomenon of natural history be described?--One might observe a child and wait until one day he manifests hope; and then one could say "Today he hoped for the first time". But surely that sounds queer! Although it would be quite natural to say "Today he said 'I hope' for the first time". And why queer? One does not say that a suckling hopes

Page Break 5

that..., but one does say it of a grown-up.--Well, bit by bit daily life becomes such that there is a place for hope in it. [Z 469a.]

Page 5

16. In this case I have used the term "embedded", have said that hope, belief, etc., were embedded in human life, in all of the situations and reactions which constitute human life. The crocodile doesn't hope, man does. Or: one can't say of a crocodile that it hopes, but of man one can.

But how would a human being have to act for us to say of him: he never hopes? The first answer is: I don't know. It would be easier for me to say how a human being would have to act who never yearns for anything, who is never happy about anything, or who is never startled or afraid of anything.

Page 5

17. Fear behaviour on fearful occasions (etc.) is a phenomenon of our life. But fear? Well, instead of "I am afraid" one could say "The phenomenon of fear is occurring in me", in which case one doesn't think of his own *behaviour*. But then could one say in the same sense, "The phenomenon of fear is occurring in him"?

Page 5

18. If I tell someone "Men think, feel,...", it seems I am making a statement of *natural history* to him. It might be intended to show him something about the difference between man and the various kinds of animals. But could one give an example of this by saying, "Yes, I myself, for instance, am now seeing"? Then is "I see..." a statement of natural history about myself? Couldn't I just as well say, "I am not seeing"?

Page 5

19. "Man thinks, is afraid, etc. etc.": that is the reply one might give to someone who asked what chapters a book on psychology should contain. [Z 468.]

Page 5

20. Where do we get the concept 'thinking' from, which we now want to consider here? From everyday language. What first fixes the direction of our attention is the word "thinking". But the use of this word is tangled. Nor can we expect anything else. And that can of course be said of all psychological verbs. Their employment is not so clear or so easy to get a synoptic view of, as that of terms in mechanics, for example. [Z 113.]

Page 5

21. Psychological words are similar to those which pass over from everyday language into medical language. ("Shock.")

Page Break 6

Page 6

22. I tell someone: "Human beings think." He asks me, "What is *thinking*?"--Now I explain the use of this word to him. But when I have finished, is the first sentence still a piece of information?

Page 6

((Couldn't an ant speak this way to an ant?))

Page 6

23. "Human beings think, grasshoppers don't." This means something like: the concept 'thinking' refers to human life, not to that of grasshoppers. And one could impart this to a person who doesn't understand the English word "thinking" and perhaps believes erroneously that it refers to something grasshoppers do.

Page 6

24. "Grasshoppers don't think." Where does this belong?--Is it an article of faith, or does it belong to natural history? If the latter, it ought to be a sentence something like: "Grasshoppers can't read and write." This sentence has a clear meaning, and even though it is perhaps never used, still it is easy to imagine a use for it.

Page 6

25. "A steam engine has a crosshead, a steam turbine doesn't." To whom, and in what context, would one say that?

Page 6

26. "Can a human being understand what 'reading' is unless he himself can read, can he understand what 'fearing' is without knowing fear, etc.?" Well, an illiterate man can certainly say that he can't read but that his son has learned how. A blind man can say that he is blind and the people around him sighted. "Yes, but doesn't he after all mean something different from a sighted man when he uses the words 'blind' and 'sighted'?" What is the ground of one's inclination to say that? Well, if someone did not know what a leopard looked like, still he could say and understand "That place is very dangerous, there are leopards there". He would perhaps all the same be said not to know what a leopard is, and so not to know, or not completely, what the word "leopard" means, until he is shown such an animal. Now it strikes us as being the same with the blind. They don't know, so to speak, what seeing is like.--Now is 'not knowing fear' analogous to 'never having seen a leopard'? That, of course, I want to deny. [Z 618, beginning at "A blind man can say".]

Page 6

27. The question is: What kind of language-games can someone who is unacquainted with fear *eo ipso* not play?

One could say, for example, that he would watch a tragedy without understanding it. And that could be explained this way: When I see someone else in a terrible situation, even when I myself have nothing to fear, I can shudder, shudder out of sympathy. But

Page Break 7

someone who is unacquainted with fear wouldn't do that. *We* are afraid along *with the other person*, even when we have nothing to fear; and it is *this* which the former cannot do. Just as I grimace when someone else is being hurt.

Page 7

28. Good; but isn't it conceivable that someone who has never felt pain could still feel it in the form of pity? So no matter what happened to him he wouldn't groan, but would whenever someone else was being hurt.

But would we really say that he feels pity? Wouldn't we say. "It really isn't pity because he isn't acquainted with any pain of his own"--? Or we could imagine people saying in such a case that God has given this man a feeling for the sorrow or fear of others. One might call something like that an intuition.

Page 7

29. "Human beings sometimes think." How did I learn what "thinking" means?--It seems I can only have learned it by living with people.--To be sure, one could imagine seeing human life in a film, or being allowed merely to observe life without participating in it. Anyone who did this would then understand human life as we understand the life of fish or even of plants. We can't talk about the joy and sorrow, etc., of fish.

Page 7

30. But of course I don't mean that as a matter of experience one can't understand it if he doesn't join in living (as if one were to say: no one can learn how to row merely by watching others rowing).--Rather, I mean that I wouldn't say either of myself (or of others) that we understood manifestations of life that are foreign to us. And here, of course, there are degrees.

Page 7

31. Thinking cannot be called a phenomenon, but one can speak of "phenomena of thinking", and everyone will know what kinds of phenomena are meant.

Page 7

32. Clearly, one can say: "Think about occasions for anger and phenomena of anger (anger-behaviour)."

But if I call *anger* a phenomenon then I have to call *my* anger, my experience of anger, a phenomenon. (A phenomenon of my inner life, for instance.)

33. Look at it purely behaviouristically: Someone says, "Man thinks wishes, is happy, angry, etc.". Imagine that these words were only

about certain forms of behaviour on certain occasions. One could suppose that whoever talks about human beings in this way had first observed these kinds of behaviour in other beings and was now saying that these phenomena could also be observed in human beings. That would be like our saying this of a species of animals.--

34. Suddenly I smile and say "...". When I smiled the thought had occurred to me.

Of what did it consist? It consisted of nothing at all; for the picture or word, etc., which may perhaps have appeared was not the thought.

35. I would like to say: Psychology deals with certain *aspects* of human life.

Or: with certain phenomena.--But the words "thinking", "fearing", etc., etc. do *not* refer to these phenomena.

36. "But how is it possible to *see* a thing according to an *interpretation*?"--The question represents it as a queer fact; as if something were being forced into a form it did not really fit. But no squeezing, no forcing took place here. [*Philosophical Investigations* II, xi, p. 200, paragraph e.]



37. Now the strange thing is that one doesn't know, as it were, what he is doing when he regards or sees the figure now as *this*, now as *that*. That is, one is inclined to ask, "How am I doing that?" "What other thing am I actually seeing?"--And as an answer to this one gets no relevant explanation.

38. For the question is not, 'What am I doing when....?' (for this could only be a psychological question)--but rather, 'What meaning does the statement have, what can be deduced from it, what consequences does it have?'

39. Anyone who failed to perceive the change of aspect would not be inclined to say, "Now it looks completely different!", or "It seems as if the picture had changed, and yet it hasn't!", or "The form has remained the same, and yet something has changed, something which I should like to call the conception, and which is seen!"--

40. To see something first as *this* and then as *that* could be a mere *game*. One could speak to a child in this way--for instance: "Now it is...!, now...!", and it reacts; I mean it laughs, and now it practices the thing in various ways (as if you were to point out that

vowels have colours). Another child neither perceives these colours nor understands what is meant by that change of aspect.

41. But what if *this* child were given the problem of locating the configuration  in the figure  (or †1 (This could be included as a problem in the child's first lessons.) Would he be unable to solve this problem (or one of finding a series of different configurations in that figure) if he were not aware of a change of aspect, if he were not inclined to say that the figure was somehow changing, becoming a different pattern, or something like that?

42. You say that a normal person would see the figure  †2 as two circles cut through by a straight line. But how does that come out? If he copies the figure, for example, should I say it comes out in the *way* he does it? If he describes the figure verbally, does it come out in the description he chooses? This choice could be determined by the convenience of representing it this particular way. Even if the child hit upon different ways of reproducing it pictorially (a different sequence of lines), would *that* be our criterion for the change of aspect?--But if he says, "Now it is...--now...", if he talks as if he *saw* a different object every time, then we'll say that he sees the figure in different ways.

43. The essential thing about seeing is that it is a *state*, and such a state can suddenly change into another one. But how do I know that a person is in such a state, and therefore is not in one comparable to a disposition, like knowing,

understanding, or having a conception? What are the logical characteristics of such a state?

Page 9

44. For to say that one recognizes the state as a state whenever one *is in it* is nonsense. *By what* does he recognize it?

Page 9

(The criterion of identity.)

Page 9

45. I want to talk about a "state of consciousness", and to use this expression to refer to the seeing of a certain picture, the hearing of a tone, a sensation of pain or of taste, etc. I want to say that believing, understanding, knowing, intending, and others, are not states of

Page Break 10

consciousness. If for the moment I call these latter "dispositions", then an important difference between dispositions and states of consciousness consists in the fact that a disposition is not interrupted by a break in consciousness or a shift in attention. (And that of course is not a causal remark.) Really one hardly ever says that one has believed or understood something "uninterruptedly" since yesterday. An interruption of belief would be a period of unbelief, not, e.g., the withdrawal of attention from what one believes, or, e.g., sleep.

(The difference between 'knowing' and 'being aware of.')[Z 85, beginning at "Really one".]

Page 10

46. This is likely to be the point at which it is said that only form, not content, can be communicated to *others*.--So one talks to oneself *about the content*. And what does that mean? (How do my words 'relate' to the content I know? And to what purpose?) [Z 87.]

Page 10

47. In these considerations we often draw what can be called "auxiliary lines". We construct things like the "soulless tribe"--which drop out of consideration in the end. That they dropped out had to be shown.

Page 10

48. "Pain is a state of consciousness, understanding is not."--"Well, the thing is, I don't *feel* my understanding."--But this explanation achieves nothing. Nor would it be any explanation to say: What one in some sense *feels* is a state of consciousness. For that would only mean: State of consciousness = feeling. (One word would merely have been replaced by another.) [Z 84.]

Page 10

49. Look at yourself when you are writing, and notice how your hand forms the letters without your actually causing it to do so. To be sure, you feel something in your hand, all sorts of tensions and pressures, but that *they* are necessary to produce these letters is something which you know nothing about.

Page 10

50. Where there is genuine duration one can tell someone: "Pay attention and give me a signal when the picture, the rattling etc. alters."

Here there *is* such a thing as paying attention. Whereas one cannot follow with attention the forgetting of what one knew or the like. [Z 81.]

Page Break 11

Page 11

51. Think of this language-game: Determine how long an impression lasts by means of a stop-watch. The duration of knowledge, ability, understanding, could not be determined in this way. [Z 82.]

Page 11

52. "But the difference between knowing and hearing surely doesn't reside simply in such a characteristic as the kind of duration they have. They are surely wholly and utterly distinct!" Of course. But one can't say: "*Know* and *hear*, and you will notice the difference". [Z 83.]

Page 11

53. One can't look at knowing and hearing to see how different they are. Just as one can't look at pine wood and a table to get an impression of their difference.

Page 11

54. If I use the language-game with the stop-watch, for example, in order to demonstrate to myself the difference between the *concepts* knowing and seeing, this certainly gives the impression that I am showing an extremely fine distinction, where the real one, after all, is enormous.

But this enormous distinction (I would always say) consists precisely in the fact that the two concepts are

embedded quite differently in our language-games. And the difference to which I called attention was merely a reference to this pervasive distinction.

Page 11

55. The child learns "I know that now" and "I hear that now". But my God!, how different the occasions, the applications, everything! How can one even compare the use? It is hard to see how to arrange them so as to show their differences.

Where the difference is so great it is hard to point to a distinction.

Page 11

56. I can say, "This word is used thus and so, that word thus and so".

The basis for comparing them is hard to see; not their difference.

Page 11

57. The general differentiation of all states of consciousness from dispositions seems to me to be that one cannot ascertain by spot-check whether they are still going on. [Z 72.]

Page 11

58. We need to reflect that a state of language is possible (and presumably has existed) in which it does not possess the general concept of sensation, but does have words corresponding to our "see", "hear", "taste". [Z 473.]

Page Break 12

Page 12

59. We call seeing, hearing,... sense-perception. There are analogies and connexions between these concepts, and these are our justification for so taking them together. [Z 474.]

Page 12

60. It can, then, be asked: what kind of connexions and analogies exist between seeing and hearing? Between seeing and touching? Between seeing and smelling?--[Z 475.]

Page 12

61. And if we ask this, then the senses, so to say, at once shift further apart from one another than they seemed to be at first sight. [Z 476.]

Page 12

62. Psychological concepts are just everyday concepts. They are not concepts newly fashioned by science for its own purpose, as are the concepts of physics and chemistry. Psychological concepts are related to those of the exact sciences as the concepts of the science of medicine are to those of old women who spend their time nursing the sick.

Page 12

63. Plan for the treatment of psychological concepts.

Psychological verbs characterized by the fact that the third person of the present is to be identified by observation, the first person not.

Sentences in the third person of the present: information. In the first person present, expression. ((Not quite right.))

Sensations: their inner connexions and analogies.

All have genuine duration. Possibility of giving the beginning and the end. Possibility of their being synchronized, of simultaneous occurrence.

All have degrees and qualitative mixtures. Degree: scarcely perceptible--unendurable.

In this sense there is not a sensation of position or movement.

Place of feeling in the body: differentiates seeing and hearing from sense of pressure, temperature, taste and pain.

(If sensations are characteristic of the position and movements of the limbs, at any rate their place is not the joint.)

One *knows* the position of one's limbs and their movements. One can give them if asked, for example. Just as one also knows the place of a sensation (pain) in the body.

Reaction of touching the painful place.

No local sign about the sensation. Any more than a temporal sign about a memory-image. (Temporal signs in a photograph.)

Page Break 13

Page 13

Pain differentiated from other sensations by a characteristic expression. This makes it akin to joy (which is not a sense-experience).

"Sensations give us knowledge about the external world."

Images:

Auditory images, visual images--how are they distinguished from sensations? Not by "vivacity".

Images tell us nothing, either right or wrong, about the external world. (Images are not hallucinations, nor yet fancies.)

While I am looking at an object I cannot imagine it.

Difference between the language-games: "Look at this figure!" and: "Imagine this figure!"

Images are subject to the will.

Images are not pictures. I do not tell what object I am imagining by the resemblance between it and the image.

Asked "What image have you?" one can answer with a picture. [Z 472, 483, 621.]

64. One would like to say: The imaged is in a different *space* from the heard sound. (Question: Why?) [Z 622, beginning of a.]

Page 13

65. I read a book and have all sorts of images while I read, i.e. while I am looking attentively. [Z 623.]

Page 13

66. People might exist who never use the expression "seeing something with the inner eye" or anything like it, and these people might be able to draw and model 'out of imagination' or memory, to mimic the characteristic behaviour of others etc. They might also shut their eyes or stare into vacancy as if blind before drawing something from memory. And yet they might deny that they then see before them what they go on to draw. [Z 624, beginning.]

Page 13

67. "Do you see the way she's coming in the door?"--and now one imitates it.

Page 13

68. That is to say, 'seeing' is inseparably connected with 'looking'. ((I.e., that is *one* way of fixing the concept, which produces a physiognomy.))

The words which describe what we see are properties of things. We don't learn their meaning in connection with the concept of 'inner seeing'.

Page Break 14

Page 14

69. But if we ask, "What is the difference between a visual picture and an image-picture?"--the answer could be: The same description can represent both what I see and what I imagine.

To say that there is a difference between a visual picture and an image-picture means that one imagines things differently from the way they appear.

Page 14

70. I might also have said earlier: The *tie-up* between imaging and seeing is close; but there is no *similarity*. [Z 625a.]

Page 14

71. The language-games employing both these concepts are radically different--but hang together. [Z 625b.]

Page 14

72. A difference: 'trying to see something' and 'trying to form an image of something'. In the first case one says: "Look, just over there!", in the second "Shut your eyes!" [Z 626.]

Page 14

73. So don't you know, after all, whether what is seen (e.g., an after-image) and an image look exactly alike? (Or should I say: *are*?)--This question could only be an empirical one, and could only mean something like: "Does it ever, or even often, happen that a person can keep an image in front of his mind uninterruptedly and for some time, and describe it in detail, as one can do, for example, with an after-image?"

Page 14

74. "Now can you still see the bird?"--"I fancy that I can still see it." That doesn't mean: Maybe I am imagining it.

Page 14

75. "Seeing and imaging are different phenomena."--The words "seeing" and "imaging" are used differently. "I see" is used differently from "I have an image", "See!" differently from "Form an image!", and "I am trying to see it" differently from "I am trying to form an image of it".--"But the phenomena are: that men see and that we form images of things." A phenomenon is something that can be observed. Now how does one observe that men see?

I can observe, e.g., that birds fly, or lay eggs. I can tell someone, "You see, these creatures fly. Notice how they flap their wings and lift themselves into the air." I can also say, "You see, this child is not

Page Break 15

blind. It can see. Notice how it follows the flame of the candle." But can I satisfy myself, so to speak, *that men see?*
"Men see."--As opposed to *what?* Maybe that they are all blind?

Page 15

76. Can I imagine a case in which I might say, "Yes, you are right, men see"?--Or: "Yes, you are right, men see, even as I do."

Page 15

77. "Seeing and understanding†1 are different phenomena."--The words "seeing" and "understanding"†1 have different meanings! Their meanings relate to a host of important kinds of human behaviour, to phenomena of human life.

To close one's eyes in order to form an image of something is a phenomenon; to strain in looking another; to follow a thing in motion with one's eyes yet another.

Imagine someone saying: "Man can see or be blind"! One could say that "seeing", "imaging", and "hoping" are simply not words for phenomena. But of course that doesn't mean that the psychologist doesn't observe phenomena. [a: Z 629.]

Page 15

78. To say that imaging is subject to the will can be misleading, for it makes it seem as if the will were a kind of motor and the images were connected with it, so that it could evoke them, put them into motion, and shut them off.

Page 15

79. Isn't it conceivable that there should be a man for whom ordinary seeing was subject to the will? Would seeing then teach him about the external world? Would things have colours if we could see them as we wished?

Page 15

80. It is just because imaging is subject to the will that it does not instruct us about the external world.

In this way--but in no other--it is related to an activity such as drawing.

And yet it isn't easy to call imaging an activity. [a: cf. Z 627.]

Page Break 16

Page 16

81. But what if I tell you: "Imagine a melody"? I have to 'sing it inwardly' to myself. That will be called an activity just as much as calculating in the head.

Page 16

82. Consider also that you can order someone to "Draw N. N. so as to be like your image of him", and that whether he does this is not determined by the likeness of the portrait. Analogous to this is the fact that I have an image of N. N. even if my image is wrong.

Page 16

83. If I say that imaging is subject to the will that does not mean that it is, as it were, a voluntary movement, as opposed to an involuntary one. For the same movement of the arm which is now voluntary might also be involuntary.--I mean: it makes *sense* to order someone to "Imagine that", or again: "Don't imagine that."

Page 16

84.†1 But doesn't the connection with the will refer merely, so to speak, to the machinery which produces or changes what is imaged (the image-picture)?--Here no picture is engendered, unless someone manufactures a picture, a real picture.

Page 16

85. The dagger which Macbeth sees before him is not an imagined dagger. One can't take an image for reality nor things seen for things imaged. But this is not because they are so dissimilar.

Page 16

86. One objection to the imagination's being voluntary is that images often beset us against our will and remain, refusing to be banished.

Page 16

Yet the will can struggle against them. But isn't calling them voluntary like calling a movement of my arm voluntary when someone forces my arm *against my will?*

Page 16

87. If someone insists that what he calls a "visual image" is like a visual impression, say to yourself once more that perhaps he is *making a mistake!* Or: Suppose that he is making a mistake. That is to say: What do you know about the resemblance of his visual impression and his visual image?! (I speak of others because what goes for them goes for me too.)

So what do you know about this resemblance? It is manifested only in the expressions which he is inclined to use; not in something he uses those expressions to say.

"There's no doubt at all: visual images and visual impressions are of the same kind!" That must be something you know from your own experience; and in that case it is something that may be true for you and not for other people. (And this of course holds for me too, if *I* say it.)

Nothing is more difficult than facing concepts *without prejudice*. (And that is the principal difficulty of philosophy.) [a, b: Z 630; c: Z 631.]

88. Forming an image of something is comparable to an activity. (Swimming.)

When we form an image of something we are not observing. The coming and going of the pictures is not something that *happens* to us. We are not surprised by these pictures, saying "Look!..." [b: Z 632.]

89. We do not banish visual impressions, as we do images. [Z 633, beginning.]

90. If we could banish impressions and summon them before our minds then they couldn't inform us about reality.--So do impressions differ from images only in that we can affect the latter and not the former? Then the difference is empirical! But this is precisely what is not the case.

91. Is it conceivable that visual impressions could be banished or called back? What is more, isn't it really possible? If I look at my hand and then move it out of my visual field, haven't I voluntarily broken off the visual impression of it?--But I will be told that that sort of thing isn't called "banishing the picture of the hand"! Certainly not; but where does the difference lie? One would like to say that the will affects images directly.

For if I voluntarily change my visual impression, then *things* obey my will.

92. But what if visual impressions could be controlled directly? Should I say, "Then there wouldn't be any impressions, but only images"? And what would that be like? How would I find out, for instance, that another person has a certain image? He would tell me.--But how would he learn the necessary words, let us say "red" and "round"? For surely I couldn't teach them to him by pointing to

something red and round. I could only evoke within myself the image of my pointing to something of the sort. And furthermore I couldn't test whether he was understanding me. Why, I could of course not even *see* him; no, I could only form an image of him.

Isn't this hypothesis really like the one that there is *only* fiction in the world and no truth?

93. And of course I myself couldn't learn or invent a description of my images. For what would it mean to say, e.g., that I was forming an image of a red cross on a white background? What does a red cross look like? *Like this?*--But couldn't a higher being know intuitively *what* images I am forming, and describe them in his language, even though *I* couldn't understand it? Suppose that this higher being were to say, "I know what image this man is now forming; it is this:..."--But how was I able to call that "knowing"? It is completely different from what *we* call "knowing what someone else is imaging". How can the normal case be compared with the one we have invented?

If I think of myself in this case as a third person, then I would have absolutely no idea what the higher being means when it says, with regard to someone who has only images and no impressions, that it knows which images that man has.

94. "But nevertheless can't I still imagine such a case?" The first thing to say is, you can *talk* about it. But that doesn't show that you have thought it through completely. (5 o'clock on the sun.)†1

95. One would also like to talk about what a visual impression and an image *look like*. And also to ask, perhaps, "Couldn't something look like my present visual impression for instance, but otherwise *behave* as an image?" And clearly there is a mistake here.

96. But imagine this: We get someone to look through a hole into a kind of peep show, and inside we now move various objects and figures about, either by chance or intentionally, so that their movement is exactly what our

viewer wanted, so that he fancies that what he sees is obeying his will.--Now could he be deluded, and believe that his visual impressions are images? That sounds totally absurd. I don't even need the peep show, but have only to look at my hand and move it, as mentioned above. But even if I could will the curtain over there to move, or could make it disappear, I should

Page Break 19

still not interpret that as something that was going on in my imagination.†1(?)

Page 19

97. I simply can't begin to take an impression for an image. But what does that mean? Could I think of a case in which *someone else* did that? Why isn't that conceivable?

Page 19

98. If someone really were to say "I don't know whether I am now seeing a tree or having an image of it", I should at first think he meant: "or just fancying that there is a tree over there". If he does not mean this, I couldn't understand him at all--but if someone tried to explain this case to me and said "His images are of such extraordinary vivacity that he can take them for impressions of sense"--should I understand it then? [Z 634.]

Page 19

99. Still, imagine a person who says, "My images are as vivid today as real visual impressions".--Would he have to be lying or talking nonsense? No, certainly not. To be sure I would first have to have him tell me how this manifests itself.

But if he were to tell me, "Often I don't know whether I see something or only have an image of it", then I wouldn't call this a case of overly vivid imaging.

Page 19

100. But must one not distinguish here: forming the image of a human face, as we say, but not in the space that surrounds me--and on the other hand: forming an image of a picture on that wall over there?

At the request "Imagine a round spot over there" one might fancy that one really was seeing one there.[Z 635.]

Page 19

101. To be sure, if I say "Isn't there really a spot over there?", and therefore perhaps look there more closely, then what I am here calling an image does *not* obey my will. And of course if I *fancy* something to be the case, that does not obey my will.

Page 19

102. You must not forget that material implication too does in fact have its use, its practical use, even if it does not occur very frequently.

Page Break 20

Page 20

103. Anyone who negates the sentence "If p, then q" negates a connection. He is saying: "It does not have to be this way." And the words "have to" point to the connection.

Page 20

104. "If p, then q" does *not* follow from "Not p and not q". It *can't* be inferred from "Not p and not q". The sense of "If p, then q" is *fundamentally* different from the sentence "p implies q", even if there is a *connection*. It is this: "p and q", which makes the implication true, also makes the sentence "If... then..." true, or at least it supports it. "p and not q" contradicts the implication as well as the "If-then" sentence, or at least it is unfavourable to its truth. "Not p and q" and "Not p and not q" verify the implication and determine nothing about the truth of "If..., then...".

Page 20

105. "If *this* happens, *that* will happen. If I am right, you pay me a shilling, if I am wrong, I pay you one, if it remains undecided, neither pays." This might also be expressed like this: The case in which the antecedent does *not* come true does not interest us, we aren't talking about it. Or again: we do not find it natural to use the words "yes" and "no" in the same way as in the case (and there are such cases) in which we are interested in the material implication. By "No" we mean here "p and not q", by "Yes", only "p and q". [Cf. Z 677.]

Page 20

106. For example, it is quite common to *bet* on the truth of a prediction. So, if we bet on the assertion "If p happens, then q will happen", then someone will say, "If you're right, I'll pay you..., if not..."; but if p does not happen the bet will be off. Here we are dealing with two different kinds of use of the negation of a sentence. And just as "not not p" is not the same as p, when double negation is meant to strengthen the negation, in the same way "p v not p", in the

sense in which *we* are using the negation, is not necessarily a tautology. In the above case, the assertion that that conditional sentence is true or false should actually assert the definite occurrence of the event.†1 For that assertion says that the conditional sentence will not remain undecided.

Page 20

107. The sentence "*Imagination is subject to the will*" is not a sentence of psychology.

Page Break 21

Page 21

108. I learn the concept 'see' in connection with 'look'. The use of the one word is connected with that of the other.

Page 21

109. If one says, "the experiential content of seeing and having an image is essentially the same", then *this* is true insofar as a painted picture can represent both what one sees and what one has an image of. Only, one mustn't allow oneself to be deceived by the myth of the *inner picture*.

Page 21

110. The 'imagination-picture' does not enter the language-game in the place where one would like to surmise its presence. [Z 636.]

Page 21

111. I learn the concept 'seeing' along with the description of what I see. I learn to observe and to describe what I observe. I learn the concept 'to have an image' in an entirely different context. The descriptions of what is seen and what is imaged are indeed of the same kind, and a description might be of the one just as much as of the other; but otherwise the concepts are thoroughly different. The concept of imaging is rather like one of doing than of receiving. Imagining might be called a creative act. (And is of course so called.) [Z 637.]

Page 21

112. "Yes, but the image itself, like the visual impression, is surely the inner picture,†1 and *you* are talking only of differences in the production, the coming to be, and in the treatment of the picture." The image is not a picture, nor is the visual impression one. Neither 'image' nor 'impression' is the concept of a picture, although in both cases there is a tie-up with a picture, and a different one in either case. [Z 638.]

Page 21

113. "But couldn't I imagine an experiential content of the same kind as visual images, but not subject to the will, and so in this respect like visual impressions?" In this case, the misleading thing is the talk about experiential content. If we talk about an experiential content which is typical of visual imaging, then the content within me must be comparable to the content within you. And, strange as it may sound, I believe one would have to say that the experiential content--if we are to use this concept here at all--is *the same* for a visual image and a visual impression. And that sounds paradoxical, because everyone will want to cry out: You're not going to tell me that these two--image and impression--could ever be mistaken for each other!--I could answer that this is as unlikely as confusing drawing and seeing, for

Page Break 22

example. But what is drawn and what is seen still could be the same thing. Image and impression do not 'look' different. [First sentence: Z 640.]

Page 22

114. But one could also say that "experiential content" does not mean the same thing when it is applied to image and impression, but only related things. If, for example, I form an image of a face exactly as it looks, and then see it later, my impression and my image have the same experiential content. One can *not* say that it is not the same on the grounds that an image and an impression never look alike.

The content of both, therefore, is *this*--(here I might point to a picture). But I wouldn't *have to* call it "the content" both times.

Page 22

115. Image and intention. Forming an image can also be compared to *creating* a picture in this way--namely, I am not imagining whoever is like my image; no, I am imagining whoever it is I mean to imagine.

Page 22

116. I believe that if you do compare imaging with a bodily movement like breathing, which sometimes happens voluntarily, sometimes involuntarily, then you mustn't compare a sense impression with a movement *at all*. The difference is not that the one takes place whether we will it or not, whereas we control the other. Rather, one concept resembles that of an action, the other doesn't. The difference is more like that between seeing my hand move--and

knowing (without seeing it) that I am moving it.

Page 22

117. "If I shut my eyes, there he is in front of me."--One could suppose that such expressions are not learned, but rather poetically formed, spontaneously. That they therefore "seem just right" to one man and then also to the next one.

Page 22

118. "I see him in front of me as plain as day!"--Well, maybe he's really standing in front of you.--"No, my picture isn't vivid enough for that."

Page 22

119. Couldn't we conceive of *this* phenomenon: By looking at a screen, we might be able to produce pictures on it, arbitrarily, 'merely by willing them'; we might be able to move them about, to have them disappear etc.,--pictures which are not only seen by the one who makes them but also by someone else.--Would what I see on this screen be something like an image? Or--perhaps to put the

Page Break 23

question more precisely: Would "I see... on the screen" mean something like "I have an image of..."?--Or should I say that the sentence "...is now appearing on the screen" corresponds to "I have an image of..."?--No; *that* is not the way it is. The difficulty here lies in my not having a clear concept of what is meant by "producing the pictures by willing them", etc. For actually the case above is not entirely fantastic: I really can form images of all sorts of things on a wall covered with spots; and if someone else who looked at the wall should know in each instance what I was imaging then this would be similar to the case described above. ((But couldn't someone who draws pictures on the wall also be said to be producing them merely by an act of the will?))

"To move by pure will"--What does that mean? That the pictures always exactly obey my will, whereas my hand in drawing, my pencil, does not? All the same in that case it would be possible to say: "Usually I form images of exactly what I want to; today it has turned out differently." Is there such a thing as 'images not coming off'? [b: Z 643.]

Page 23

120. If there isn't, then this will be explained by saying that the image-picture is non-corporeal and does not resist the will--neither by inertia nor by any other means.

No; "I see... on the screen" cannot correspond to my imaging. Neither can "I produce... on the screen"--for then imaging could succeed or fail. This would be better: "For me what is on this screen now is a picture of..."†1

Page 23

121. To be sure, there is a language-game with the order "Imagine...!"--but can this really be that simply assimilated to "Turn your head to the right!"? Or, to put it differently: Does it make sense simply to say that image-pictures, inner pictures, obey my will? (N.B.: *not* "my wish".)

Page 23

122. For those things which are normally said to follow or not to follow the will are not 'inner pictures'. It is not clear therefore, that the concept of following can be applied to the other category directly.

Page 23

123. (Clearly the 'arbitrariness' of the imagination cannot be compared to the movement of bodies; for someone else is also competent to judge whether the movement has taken place; whereas with the movement of my images the whole point would always be

Page Break 24

what I said I saw--whatever anyone else sees. So really moving objects would drop out of consideration, since no such thing would be in question.) [Z 641.]

Page 24

124. If then one said: "Images are inner pictures, resembling or exactly like my visual impressions, only subject to my will"--the first thing is that this doesn't yet make sense.

For if someone has learnt to report what he sees over there, or what *seems* to him to be over there, it surely isn't clear to him what it would mean if he were ordered now to see *this* over there, or now to have *this* seem to him to be over there. [Z 642.]

Page 24

125. Granted, there is a certain relationship between imaging and an action which is expressed in the possibility of ordering someone to perform either; but the *degree* of this relationship has yet to be investigated.

Page 24

126. "Move your inner picture!" might mean: move the object.

Page 24

127. "Move what you see."

Page 24

It might also mean: take something that influences your visual impressions.

Page 24

128. What a strange phenomenon that a child can actually learn human language! That a child who knows nothing can start out and learn by a sure path this enormously complicated technique.

This thought occurred to me when on a certain occasion I became conscious of how a child starts *with nothing* and one day uses negations, just as we do!

Page 24

129. With the sentence "Images are voluntary, sensations are not", one differentiates not between sensations and images, but rather between the language-games in which we deal with these concepts.

Page 24

130. There are what can be called phenomena of seeing and phenomena of imaging; and there is the concept of seeing and the concept of imaging. Within both pairs one can speak of '*differences*'.

Page Break 25

Page 25

131. If one says "Imagination has to do with the will" then the same connection is meant as with the sentence "Imaging has nothing to do with observation".

Page 25

132. I said there were phenomena of seeing--what did I mean by that? Well, for instance, everything that can be portrayed in pictures, and that would be described as 'seeing'. Exact observing; looking at a language; someone blinded by light; the look of joyous surprise; turning away so as not to see something. All the kinds of behaviour which distinguish a sighted man from a blind one. (After all, there is a reason why precisely *these* pictures taken from human life occur to me at this point.)

Page 25

133. Phenomena of seeing--that is, what the psychologist observes.

Page 25

134. Someone says: "I see a house with green shutters." And you say: "He's not *seeing* it, he's merely imagining it. He's not even looking; don't you see him staring into space?"--*Very loosely*, it could also be put this way: "That's not the way it looks when somebody sees something; rather, that's the way it looks when he has an image of something." In this case we're comparing phenomena of seeing with phenomena of imagining. Likewise if we were to observe two members of an unknown tribe using a word as they perform a certain activity--a word which we have come to recognize as an equivalent of our "seeing". And we follow their use of that word upon this occasion, and come to the conclusion that here it must mean "to see with the inner eye". (Similarly, one might also come to the conclusion that the word must here mean *to understand*.)

Page 25

135. What does it mean to say, for example, that 'see' hangs together with 'observe'?--When we learn how to use "see" we learn to use it simultaneously and in conjunction with "look", "observe", etc.

Page 25

136. Just as in a chess game we learn to use the king in connection with the pawns and the word "king" together with the word "checkmate".

Page 25

137. A language-game comprises the use of *several* words. [Z 644.]

Page Break 26

Page 26

138. Nothing could be more mistaken than to say: seeing and forming an image are different activities. That is as if one were to say that moving and losing in chess were different activities. [Z 645.]

Page 26

139. The sentence "Forming an image is voluntary, seeing isn't", or a sentence like this can be misleading.

Page 26

When we learn as children to use the words "see", "look", "image", voluntary actions and orders come into play. But in a different way for each of the three words. The language-game with the order "Look!" and that with the order "Form an image of...!"--how am I ever to compare them?--If we want to train someone to react to the order

"Look...!" and to understand the order "Form an image of...!" we must obviously teach him quite differently. Reactions which belong to the latter language-game do not belong to the former. There is of course a close tie-up of these language-games; but a resemblance?--Bits of one resemble bits of the other, but the resembling bits are not homologous. [b: Z 646.]

Page 26

140. I could imagine something similar for actual games. Two essentially different games--games which might differ from each other in important respects far more than checkers and chess--could feature the same board and the same moves, only, if I might put it this way, in different positions. In the one game, e.g., the task might be to check-mate†1 the other player; in the other game the whole process of check-mating†2 would be given in advance, and the two players would have a quite different task in connection with it. For instance, the players might be given two ways of check-mating†2 the other, and they would have to compare the two from a psychological point of view. Analogously there is a game: to solve a crossword puzzle, and another one: somehow to test the value of several different solutions I have been given to the puzzle. [First sentence: Z 647.]

Page 26

141. Seeing is subject to the will *in a different way* from forming an image.
Or: 'seeing' and 'forming an image' are related differently to 'willing'.

Page Break 27

Page 27

142. Nevertheless, images seem to be dull reflections of sense-impressions. When does this seem to be the case, and to whom? Of course there is such a thing as clarity and unclarity in images. And if I say "My image-picture of him is much less well-defined than the visual impression I have when I see him", then this is true, for I cannot describe him nearly as accurately by relying on my image as I can when he is in front of me.†1 Still, it is possible for someone's eyesight to deceive him to such an extent that the sight of another man is much less clear than the image of him.

Page 27

143. If I, and if anyone else, can imagine a pain, or at least we say we can--how is it to be found out whether we are imagining it right, and how accurately we are imagining it? [Z 535.]

Page 27

144. Couldn't there be people who could describe a person's features in minute detail from memory, who even say that they now suddenly know what he looks like--but who would emphatically deny, when they were asked, that at that moment they in any way 'saw' the person 'before them' (or anything like that)? People who would find the expression "I see him before me" *totally inappropriate*?

This seems to me to be a very important question. Or even: the important question is whether this question makes sense.--What reason do I have, after all, to believe that this is not the case for all of us? Or, how can I decide the question whether someone else (I'm excluding myself for the time being) is really 'forming a visual image' of somebody, or is merely able to describe him in visual terms (to draw him etc.)--plus the fact that he is familiar with 'illumination', if I might phrase it this way, or a state of illumination similar to "Now I know". ((Genuine duration.))

Page 27

145. *Visual* imaging is *not* just characterized by an ability to draw, and things like that, but also by more subtle shades of behaviour.

In any case, the *description* of the image belongs to the language-game of "forming an image". (That does not mean that in borderline cases this statement cannot appear: "I can form an exact image of it, but I simply cannot describe it." A game allows for borderline cases--a rule for exceptions. But the exception and the rule could not change place without destroying the game. The 'transition from quantity to quality'?)

Page Break 28

Page 28

146. "If exception and rule change place then it just is not the same thing any more!"--But what does that mean? Maybe that our attitude toward the game will then change abruptly. Is it as if after a gradual loading of one side and lightening of the other, there was a *non-gradual* tipping of the balance?

147. What could the description of the image of a sensation of movement look like?

Page 28

148. Continuation of the classification of psychological concepts.

Emotions. Common to them: genuine duration, a course. (Rage flares up, abates, vanishes, and likewise joy, depression, fear.)

Distinction from sensations: they are not localized (nor yet diffuse!).

Common: they have characteristic expression-behaviour. (Facial expression.) And this itself implies characteristic sensation too. Thus sorrow often goes with weeping, and characteristic sensations with the latter. (The voice heavy with tears.) But the sensations are not the emotions. (In the sense in which the numeral 2 is not the number 2.)

Among emotions the directed might be distinguished from the undirected. Fear *at* something, joy *over* something.

This something is the object, not the cause of the emotion.

The language-game "I am afraid" already contains the object.

"Anxiety" is what undirected fear *might* be called, in so far as its manifestations are related to those of fear.

The *content* of an emotion--here one imagines something like a *picture*, or something of which a picture can be made. (The darkness of depression which descends on a man, the flames of anger.)

The human face too might be called such a picture and its alterations might represent the *course* of a passion.

What goes to make them different from sensation: they do not give us any information about the external world. (A grammatical remark.)

Love and hate might be called emotional dispositions, and so might fear in one sense.

It is one thing to feel acute fear, and another to have a 'chronic' fear of someone. But fear is not a sensation.

'Horrible fear': is it the *sensations* that are so horrible?

Page Break 29

Page 29

Typical causes of pain on the one hand, and of depression, sorrow, joy on the other. Cause of these also their object.

Pain-behaviour and the behaviour of sorrow.--These can only be described along with their external occasions. (If a child's mother leaves it alone it may cry because it is sad; if it falls down, from pain.) Behaviour and kind of occasion belong together. [a-f: Z 488; g-i: Z 489; j: Z 490; k-l: Z 491; m-p: Z 492.]

Page 29

149. Perhaps someone will say: How can you characterize the concept 'pain' by referring to the occasions on which pain occurs? Pain, after all, is what it is, whatever causes it!--But ask: How does one identify pain?

The occasion determines the usefulness of the signs of pain.

Page 29

150. The concept of pain is simply embedded in our life in a certain way. It is characterized by very definite connexions.

Just as in chess a move with the king only takes place within a certain context, and it cannot be removed from this context.--To the concept there corresponds a technique. (The eye†1 smiles only within a face.) [a: cf. Z 532, 533.]

Page 29

151. Only surrounded by certain normal manifestations of life, is there such a thing as an expression of pain. Only surrounded by even more far-reaching particular manifestations of life, such as the expression of sorrow or affection. And so on. [Z 534.]

Page 29

152. Emotional attitudes (e.g. love) can be put to the test, but not emotions. [Cf. Z 504.]

Page 29

153. I am inclined to say: emotions can *colour* thoughts; bodily pain cannot. Therefore let us speak of sad thoughts, but not, analogously, of toothache thoughts. It is as if one might say: Fear or indeed hope could consist only of thoughts, but pain could not. Above all pain has the characteristics of sensation and fear does not. Fear hangs together with misgivings, and misgivings are thoughts.

Page Break 30

Page 30

154. Hope can be called an emotion. That is, it can be placed in the same category as fear, anger, joy. It is related to belief, which is *not* an emotion. There is no bodily expression typical of belief.

Compare the meaning of "uninterrupted pain" with "uninterrupted anger", jubilation, sorrow, joy, fear, and on the other hand, "uninterrupted belief", or "uninterrupted hope".

But again, fear, hope, longing, expectation, are hard to compare with each other. Longing is a mental preoccupation with a certain object. Fear of an *event* (apprehension) seems to be similar; but not the fear of a dog

barking at me. Here two different words can be used. Likewise "expect" can mean: to believe that this or that will happen--but also: to occupy one's time with thoughts and activities of expectation, i.e., *wait for*.

Page 30

155. Belief is not any kind of occupation with the object of belief. Fear, however, longing, and hope, occupy themselves with their objects.

In a scientific investigation we say all sorts of things, we make many statements whose function in the investigation we don't understand. For not everything is said with a conscious purpose; our mouth simply runs. We move through conventional thought patterns, automatically perform transitions from one thought to another according to the forms we have learned. And then finally we must sort through what we have said. We have made quite a few useless, even counter-productive motions and now we must clarify our movements of thought philosophically. [b: *Culture and Value*, p. 64.]

Page 30

156. If I tell you "I have been afraid of his arrival all day long"--I could, after all, go into detail: Immediately upon awakening I thought.... Then I considered.... Time and again I looked out of the window, etc., etc. This could be called a report about fear. But if I then said to somebody, "I am afraid..."--would that be as it were a groan of fear, or an observation about my condition?--It could be either one, or the other: It might simply be a groan of fear; but I might also want to report to someone else how I have been spending the day. And if I were now to say to him: "I have spent the whole day in fear (here details might be added) and now too I am full of anxiety"--what are we to say about this mixture of report and

Page Break 31

statement? Well what should we say other than that here we have the use of the word "fear" in front of us?

Page 31

157. If there were people who felt a stabbing pain in their left side in those cases where we express misgivings with feelings of anxiety--would this stabbing sensation take the place with them of our feeling of fear?--So if we observed these people and noticed them wincing and holding their left side every time they expressed a misgiving, i.e., said something which for us at any rate would be a misgiving--would we say: These people sense their fear as a stabbing pain? Clearly not.--

Page 31

158. Why does one use the word "suffering" for pain as well as for fear? Well, there are plenty of tie-ups.--[Z 500.]

Page 31

159. Suppose it were said: Gladness is a feeling, and sadness consists in *not* being glad.--Is the absence of a feeling a feeling? [Z 512.]

Page 31

160. If I say "Every time I thought about it I was afraid"--did fear *accompany* my thoughts?--How is one to conceive of separating what does the accompanying from what is accompanied?

We could ask: How does fear pervade a thought? For the former does not seem to be merely concurrent with the latter. To be sure, if I say "I think about it with anguish", the thought expressed in these words might seem to run concurrently with a certain feeling in my chest, and *this* might seem to be alluded to. But the use of this sentence is something different from that.

One also says: "Thinking about it takes my breath away", and means not only that as a matter of experience this or that sensation or reaction accompanies this thought.

Page 31

161. To the utterance: "I can't think of it without fear" one replies: "There's no reason for fear, for..." That is at any rate *one* way of dismissing fear. Contrast with pain.

Is disgust a sensation?--Is it localized?--And it has an object, as does fear. And there are characteristic sensations here. [a: Z 501.]

Page Break 32

Page 32

162. Indeed, you must always ask yourself: What do you tell someone else with these sentences? And this means: What use can he make of them?

Page 32

163. I *give notice* that I am afraid.--Do I recall my thoughts of the past half hour in order to do that, or do I let a thought of the dentist quickly cross my mind in order to see how it affects me; or can I be uncertain of whether it is really fear of the dentist, and not some other physical feeling of discomfort?

Page 32

164. Or is giving notice of being afraid like a very slight groan of fear? No; for in groaning I don't necessarily want to tell somebody else that I am afraid. The notice is, as it were, part of a *conversation*.

Page 32

165. Can one say: "I am only afraid of the operation at the moment I am thinking about it"? And does that mean: while I am pondering over it? Can't I dread something even when I am not expressly, so to speak, thinking it over? Can't I say to someone "I dread this meeting" even though I see the event, as it were, merely out of the corner of my eye?

Page 32

166. Let us just forget entirely that we are interested in the state of mind of a frightened man. It is certain that under given circumstances we may also be interested in his behaviour as an indication of how he will behave in the future. So why should we not have a word for this? It can be either a verb or an adjective.

It might now be asked whether this word would really relate simply to behaviour, simply to bodily changes. And this we wish to deny. There is no future in simplifying the use of this word in this way. It relates to the behaviour under certain external circumstances. If we observe these circumstances and that behaviour we say that a man is....

If the word is used in the *first* person then the analogy with its use in the third person is the same as the one between "I am cross-eyed" and "He is cross-eyed". [a, b,--except for the last sentence of a and the last two words of b: Z 523.]

Page 32

167. I now want to say that humans who employ such a concept would *not* have to be able to describe its use. And were they to try, it is possible that they would give a quite inadequate description. (Like most people, if they tried to describe the use of paper money correctly.) [Cf. Z 525.]

Page Break 33

Page 33

168. It is possible, for example, that they make this statement about someone without being able to say with any degree of certainty, *which* aspect of his behaviour causes them to make the statement. They might say "I see it; but I don't exactly know *what* I see". Just as we say: "Something about him has changed, but I don't know exactly what." Future experience might prove them right.

Page 33

169. Now it is conceivable that some people might have a verb whose third person would be *exactly* equivalent to our "He is afraid"; but whose first person is not equivalent to our "I am afraid". For the assertion using the first person would be based on self-observation. It would not be an *utterance* of fear and there would be a "I believe I...", "It seems to me that I...". Now probably this first person would not be used at all, or only very rarely. If my behaviour in a certain situation were filmed, then when the film was shown to me I could say "My behaviour creates the impression...".

Page 33

170. That statement "I believe he feels what I feel in such circumstances" does not yet exist here: The interpretation, that is, that I see something in myself which I surmise in him.

For in reality that is a rough interpretation. In general I do not surmise fear in him--I *see* it. I do not feel that I am deducing the probable existence of something inside from something outside; rather it is as if the human face were in a way translucent and that I were seeing it not in reflected light but rather in its own.

Page 33

171. "I dread it."--That is not a representation of something I see. As a matter of fact, as soon as I *look*, I see nothing, or at least not what I really meant. Then it is as if this were such a thin veil that one could know about it but not actually see it. As if dread were a very subtle, muffled sound alongside the everyday sounds, a sound which I could only *sense* and not really hear.

Imagine a child who for a long time had been unable to learn how to speak and who suddenly used the expression "I dread...", which it had heard from adults. And its face and the circumstances and the consequences make us say: He really meant it. (For one could always say: "One fine day the child starts using the words.") I chose the case of a child because what is happening in him is stranger to us than it would be with an adult. What do I know--I'm inclined to say--about a *background* for the words "I dread..."? Does the child suddenly let me look into him?

Page Break 34

Page 34

172. This matter also calls to mind hearing a sound *from a particular direction*. It is almost as if one felt the

heaviness around the stomach from the direction of the fear. That means really that "I am sick with fear" does not assign a *cause* of fear. [Cf. Z 496.]

Page 34

173. Are there psychological syndromes; and is 'expecting' one of them? Possibly waiting for something, but not 'expecting'.

Page 34

174. That there is a fear-syndrome, for example, does not mean that fear is a syndrome. [Cf. Z 502.]

Page 34

175. If I say "I am anxiously awaiting his coming", this means: I am *occupied* with his coming (in thought and, one can also say: in thought and in action). The state of anxiously awaiting can thus be called a syndrome. But it is not, so to speak, a syndrome of actions of a certain kind; the crucial point is rather the intention of the actions, and thus a *motive*, and not a *cause*.

Page 34

176. If I say that I am using the words "I'm in pain", "I'm looking for him", etc. etc. as a piece of information, not as a natural sound,†1 then this characterizes my intention. For instance, I might want somebody else to react to this in a certain way.

But here I still owe an explanation of the concept of intention, and intention is by no means some sort of feeling to which I want to reduce everything; at whose door, so to speak, I am laying everything. (For intention is *not* a feeling.)

Page 34

177. If we call fear, sorrow, joy, anger, etc. mental states, then that means that the fearful, the sorrowful, etc. can report: "I am in a state of fear" etc., and that this information--just like the primitive utterance--is not based on observation.

Page 34

178. Intent, intention, is neither an emotion, a mood, nor yet a sensation or image. It is not a state of consciousness. It does not have genuine duration. Intention can be called a mental disposition. This term is misleading inasmuch as one does not perceive such a disposition within himself as a matter of experience. The *inclination* toward jealousy, on the other hand, is a disposition in the true sense. Experience teaches me that I have it. [First three sentences: Z 45.]

Page Break 35

Page 35

179. "I intend" is not an expression of an experience.

There is no cry of intention, any more than there is one of knowledge or belief.

However, one might very well call the *decision* with which an intention frequently begins an experience.

Page 35

180. Is a decision a thought? It can be the end of a chain of thought.

Page 35

181. Someone tells me something; I look at him in amazement; he explains... My puzzled look was equivalent to the question: "How come?" or "What do you mean?" or "Why?" or "You want to do *that*? You who always...?"--The sudden thought.

Page 35

182. Intentional--unintentional. Voluntary--involuntary.

What is the difference between a gesture of the hand without a particular intention and the same gesture which is intended as a sign?

Page 35

183. Let us imagine someone doing work that involves comparison, trial, choice. Say he is constructing an appliance out of various bits of stuff with a given set of tools. Every now and then there is the problem "Should I use *this* bit?"--The bit is rejected, another is tried. Bits are tentatively put together, then dismantled; he looks for one that fits etc., etc. I now imagine that this whole procedure is filmed. The worker perhaps also produces sound-effects like "Hm" or "Ha!" As it were sounds of hesitation, sudden finding, decision, satisfaction, dissatisfaction. But he does not utter a single word. Those sound-effects may be included in the film. I have the film shown me, and now I invent a soliloquy for the worker, things that fit his manner of work, its rhythm, his play of expression, his gestures and spontaneous noises; they correspond to all this. So I sometimes make him say "No, that bit is too long, perhaps another'll fit better."--Or "What am I to do now?"--"Got it!"--Or "That's not bad" etc.

If the worker can talk--would it be a falsification of what actually goes on if he were to describe that precisely

and were to say, e.g., "Then I thought: No, that won't do, I must try it another way" and so on--although he had neither spoken during the work nor imagined these words?

Page Break 36

Page 36

I want to say: May he not later give his wordless thoughts in words? And in such a fashion that we, who might see the work in progress, could accept this account?--And all the more, if we had often watched the man working, not just once? [Z 100.]

Page 36

184. Of course we cannot separate his 'thinking' from his activity. For the thinking is not an accompaniment of the work, any more than of thoughtful speech. [Z 101.]

Page 36

185. Imagine a person who is taking a break in his work, and is staring ahead seemingly pondering something, in a situation in which we would ask ourselves a question, weigh possibilities--would we necessarily say of him that he was reflecting? Is not one of the prerequisites for this that he *be in command* of a language, i.e., be able to express the reflection, if called upon to do so?

Page 36

186. Now if we were to see creatures at work whose *rhythm* of work, play of expression etc. was like our own, but for their not *speaking*, perhaps in that case we should say that they thought, considered, made decisions. That is: in such a case there would be a *great deal* which is similar to the action of ordinary humans. And it isn't clear *how much* has to be similar for us to have a right to apply to them also the concept 'thinking', which has its home in *our* life. †1 [Cf. Z 102.]

Page 36

187. And anyhow what should we come to this decision for?

We shall be making an important decision between creatures that can learn to do work, even complicated work, in a 'mechanical' way, and those that make trials and comparisons as they work.--But what should be called "making trials" and "comparisons" can in turn be explained only by giving examples, and these examples will be taken from our life or from a life that is like ours. [Z 103.]

Page 36

188. And if their trial-making were to take on the form of producing a kind of model (or even a drawing) then we would say without hesitation that these beings were thinking. To be sure one could also speak here of an operation with signs.

Page Break 37

Page 37

189. "But couldn't the operation with signs also take place mechanically?"--Surely; i.e. this too has to take place in a certain context in order for us to be able to say it is not mechanical.

Page 37

190. It seems therefore, that our concepts, the use of our words, are constrained by a factual framework. But how can that be?! How could we describe the framework if we did not allow for the possibility of something else?--One is inclined to say that you are making all logic into nonsense!

Page 37

191. The problem which worries us here is the same as in the case of this observation: "Human beings couldn't learn to count if all the objects around them were rapidly coming into being and passing away.

Page 37

192. But you can also say: "If you don't have any little sticks, stones, etc. at hand, then you can't teach a person how to calculate." Just as you can say "If you have neither a writing surface nor writing material at hand then you can't teach him differential calculus" (or: then you can't work out the division $76570 \div 319$).

We don't say of a table and chair that they think; neither do we say this of a plant, a fish, and hardly of a dog; only of human beings. And not even of all human beings.

But if I say "A table does not think", then that is not similar to a statement like "A table doesn't grow". I shouldn't know 'what it would be like if' a table were to think. And here there is obviously a gradual transition to the case of human beings. [b, c: cf. Z 129.]

Page 37

193. "Thinking is a mental activity."--Thinking is *not* a bodily activity. Is thinking an activity? Well, one may tell someone: "Think it over! ". But if someone in obeying this order talks to himself or even to someone else, does he

then carry out *two* activities? Therefore thinking really can't be compared to an activity at all. For one cannot say that thinking means: speaking in one's imagination. This can also be done without thinking. [Z 123, up to "Therefore thinking...".]

Page 37

194. You must never forget that "think" is an everyday word, just as are all other psychological terms.

It is not to be expected of this word that it should have a unified employment; rather it is to be expected that it doesn't have it. [a: cf. Z 113; b: Z 112.]

Page Break 38

Page 38

195. If someone is pondering over a problem and suddenly I show him a certain drawing, then maybe he will exclaim "Oh, *that's* how it is!", or "Now I know". When questioned about what went on inside him just then, in this case he will very likely say simply: "I saw the drawing." I am describing this case in order to replace a process within the imagination with one of seeing. Will he now say: "The moment I saw the drawing the whole solution appeared before my eyes"? When I come to his aid with the drawing he might also say: "Yes, now it's easy!"

Page 38

196. "I see clearly how the word is used"--will that be said even when one is shown, alongside the word, a picture which illustrates its meaning?

((In this case, the experience of meaning seems to be drowned out by what has been seen.))

Page 38

197. We say: Grass is green, chalk white, coal black, blood red, etc.--What would it be like in a world in which this would be impossible, i.e., in which the other qualities of a thing were unconnected with†1 its colour? This is an important question, whether or not it has been put correctly, and is merely an example of countless similar questions.

Page 38

198. Suppose I were to come to a country where the colour of things--as I would say--changed constantly, say because of a peculiarity of the atmosphere. The inhabitants never see unchanging colours. Their grass looks green at one moment, red at the next, etc. Could these people teach their children the words for colours?--First of all, it might be that their language *lacked* words for colours. And if we found this out we might explain it by saying that they had little or no use for certain language-games.

Page 38

199. How could people learn the use of the words for colour in a country where everything was only *one* colour?

But can I say now: "The only reason for our being able to use the names for colours is that things of different colours exist in our environment and that..."?? Here the difference between logical and physical possibility is not being seen.--Under what conditions the language-game with the names for colours is physically impossible--i.e., properly speaking, not probable--does not interest us.

Without chess-men one can't play chess--that is the impossibility which interests us.

Page Break 39

Page 39

200. One learns the word "think", i.e. its use, under certain circumstances, which, however, one does not learn to describe. [Z 114.]

Page 39

201. We learn to say it perhaps only of human beings, we learn to assert or deny it of them. The question "Do fishes think?" does not exist among our applications of language, *it is not raised*. (What can be more natural than such a set-up, such a use of language!) [Z 117.]

Page 39

202. "No one thought of *that* case"--we may say. Indeed, I cannot enumerate the conditions under which the word "to think" is to be used--but if a circumstance makes the use doubtful, I can say so, and also *how* the situation is deviant from the usual ones. [Z 118.]

Page 39

203. And here something about my language-game No. 2†1 should be said.--*Under what circumstances* would one really call the sounds of the builder, etc., a language? Under *all* circumstances? Certainly not!--Was it wrong then to isolate a rudiment of language and call it language? Should one perhaps say that this rudiment is a language-game only in the context of the whole that we usually call our language?? [Cf. Z 98.]

Page 39

204. Now in the first place this *surrounding* is not the mental accompaniment of speech; it is not the 'meaning' and 'understanding' which one is inclined to consider as essential to language.

Page 39

205. It would only be dangerous to me if someone were to say: "You're just tacitly assuming that these people *think*; that they are like people as we know them in *that* respect; that they do not carry on that language-game merely mechanically. For if you imagined them doing that, you yourself wouldn't call it speaking."

What am I to reply to this? Of course it is true that the life of those men must be like ours in many respects and that I said nothing about this similarity. But the important thing is precisely that I can imagine their language, and their thinking too, as primitive; that there is such a thing as 'primitive thinking' which is to be described via primitive *behaviour*. [Cf. Z 99.]

Page 39

206. I say of someone: He's comparing two objects. I know what that looks like, how that is done. I can demonstrate it to someone.

Page Break 40

Page 40

Nevertheless I wouldn't call what I was demonstrating 'comparing' under *all* circumstances.

I can imagine cases in which I would not be inclined to say that comparing was going on; but as for describing the circumstances in which comparing occurs, that I could not do.--But I *can teach* a person the use of the word! For a description of those circumstances is not needed for that. [Last sentence: Z 115.]

Page 40

207. I just teach him the word *under particular circumstances*.†1 [Z 116.]

Page 40

208. Sometimes it really seems that thinking runs concurrently with talking (reading, for example). Not that it could then be isolated from reading, however. Rather, what accompanies the words is like a series of small secondary movements. It is like being led along a street, but casting glances right and left into all the side streets.

Page 40

209. Suppose I were to show somebody a list of the trips or errands he is to run for me. We know each other well and all he needs are hints for him to know what he is to do. Now the list is all hints of this sort. He goes through it and says after each hint "I understand". And he does; he could explain every single item, if asked to do so.

Then I could ask him: "Did you understand everything?" Or: "Look through the list and see whether you understand everything." Or: "Do you know what you have to do here?"--What did he have to do to make sure that he had understood the hints? Is it as if he had to perform a mental calculation for each item? If that were necessary he could later give a verbal account of the calculation and it would become clear whether he calculated correctly.--But generally that is *not* necessary. We do not prescribe what the other is to do if he is to understand the list; and whether he really understood is determined from what he does later, or from an explanation we might ask him to give.

Page 40

210. One could say: anyone who checks his comprehension in this way is moving along a bit of the way on the path he is later to follow. And that might indeed be so. Although there is no reason to assume it is so. For if he only goes part of the way--why shouldn't he be able

Page Break 41

to see that he knows which way he is to go, without actually going it? But that does not mean that the paths are not actually followed part of the way. However, it can also be that what we later come to regard as the '*germ*' of a thought or an action is in its own nature not that at all.

Page 41

211. Now suppose someone were to say: That simply means that "thinking" has a certain end, that it fulfils a certain purpose. *How* each person performs it and whether he does it the same today as last time, is irrelevant.--Then I could answer: And if doing nothing at all leads to the proper end, then thinking in this case would consist in doing nothing.

One says: "Make sure that you understand each point!"

And if I were then to ask, "How should I make sure?", what advice would I be given? I would be told: "Ask yourself, whether..."

Page 41

212. Isn't it the same here as with a calculating prodigy?--He has calculated right if he has got the right answer.

Perhaps he himself cannot say what went on in him. And if we were to hear it, it would perhaps seem like a queer *caricature* of calculation. [Cf. Z 89b.]

Page 41

213. When someone says "Non-verbal thinking is also possible", this is misleading. The point is not to be able to do a certain thing without also doing something else at the same time; as, for example, with "It is possible to read without moving one's lips".

Page 41

214. If, for instance, there were only quite few people who could get the answer to a sum without speaking or writing, they could not be adduced as testimony to the fact that calculating can be done without signs. The reason is that it would not be clear that these people were 'calculating' at all. Equally Ballard's†1 testimony (in James) cannot convince one that it is possible to think without a language.

Indeed, where no language is used, why should one speak of 'thinking'? If this is done, it shows something about the *concept* of thinking. [Z 109.]

Page 41

215. For instance one could have two (or more) different words: one for 'thinking out loud'; one for thinking as one talks in the imagination; one for a pause during which something or other floats

Page Break 42

before the mind (or doesn't), after which, however, we are able to give a confident answer.

We could have two words: one for a thought expressed in a sentence; one for the lightning thought which I may later 'clothe in words'. [Cf. Z 122.]

Page 42

216. If we include 'thinking silently as one is working' in our considerations, then we see that our concept 'thinking' is widely ramified. Like a ramified traffic network which connects many out-of-the-way places with each other.

In all of these widely separated cases we speak of 'thinking'.

Page 42

217. In all of these cases we say that the mind is not idle, that something is going on inside it; and we thereby distinguish these cases from a state of stupor, from mechanical actions.

Page 42

218. 'Thinking', a widely ramified concept. Couldn't the same be said of 'believing', 'doing', 'being glad'?

And where does the remark that this concept is widely ramified really belong?--Well it will be made to someone setting out to consider the branching of this concept.

Page 42

219. It's really very odd that we have no difficulty whatsoever seeing a face in a figure such as this†1  even though the resemblance of the one angle to a nose and of the other to a forehead etc., is incredibly slight, or there hardly is a resemblance there. To repeat: We have no difficulty whatsoever seeing a human face in these lines; one would like to say: "There *is* a face like that." Again: "True, this is the caricature of a human face, but a caricature of one which could really exist."--Just as one has no difficulty seeing a human face in the grey-and-white of a photograph.--And what does that mean? Well, we watch a movie, for instance, and follow everything that goes on with concern, as if there were real people in front of us.

Page 42

220. 'Thinking', a widely ramified concept. A concept that comprises many manifestations of life. The *phenomena* of thinking are widely scattered. [Z 110.]

Page Break 43

Page 43

221. And don't you want to say that *one* aspect appears in all of these word-uses, a unitary, genuine concept?--But how much is there in that? May not the force of habit weld all of this together?

Page 43

222. If somebody tells me of some incident, or asks me an everyday question (e.g. what time is it), I'm not going to ask him whether he was thinking while he was telling me or asking me. Or again: It would not be immediately clear in what circumstances one might have said that he did this without thinking--even though one can imagine such circumstances. (Here there is a relationship with the question: What is to be called a 'voluntary' act.)

223. The thoughtful expression, the expression of the idiot. The frown of reflection, of attention.

224. Now imagine a human being, or one of Köhler's monkeys, who wants to get a banana from the ceiling, but can't reach it, and thinking about ways and means finally puts two sticks together, etc. Suppose one were to ask, "What must go on inside him for this to take place?"--This question seems to make some sort of sense. And perhaps someone might answer that unless he acted through chance or instinct, the monkey must have seen the process before its mental eye. But that would not suffice, and then again, on the other hand, it would be too much. I want the monkey to *reflect* on something. First he jumps and reaches for the banana in vain, then he gives up and perhaps he is depressed--but this phase does not have to take place. How can catching hold of the stick be something he gets to *inwardly* at all? True, he could have been shown a picture that depicts something like that, and then he could act that way; or such a picture could simply float before his mind. But that again would be an accident. He would not have arrived at this picture by reflection. And does it help to say that all he needed to have done was somehow to have seen his arm and the stick as a unity? But let us go ahead and assume a propitious accident! Then the question is: How can he *learn* from the accident? Perhaps he just happened to have the stick in his hand and just happened to touch the banana with it.--And what further must now go on in him? He says to himself, as it were, "That's how!", and then he does it with signs of full consciousness.--If he has made some combination in play, and he now uses it as a method for doing this and that, we shall say he thinks.--In *considering* he would mentally review ways and means. But to do this he must already have some in stock. Thinking gives him the possibility of *perfecting* his

methods. Or rather: He 'thinks' when, in a definite kind of way, he perfects a method he has. [Z 104--beginning at "If he has made".]

225. It could also be said that he thinks when he *learns* in a particular way. [Z 105.]

226. And this too could be said: Someone who *thinks* as he works will intersperse his work with *auxiliary activities*. The word "thinking" does not now mean these auxiliary activities, just as thinking is not talking either. Although the concept 'thinking' is formed on the model of a kind of imaginary auxiliary activity. (Just as we might say that the concept of the differential quotient is formed on the model of a kind of imaginary quotient.) [Z 106.]

227. These auxiliary activities are not the thinking; but one imagines thinking as that which must be flowing under the surface of these expedients, if they are not after all to be mere mechanical procedures. [Z 107.]

228. Thinking is the imaginary auxiliary activity; the invisible stream which carries and connects all of these kinds of actions.--The grammar of "thinking", however, is assimilated to that of "speaking".

229. So one might distinguish between two chimpanzees with respect to the way in which they work, and say of the one that he is thinking and of the other that he is not.

230. But here of course we wouldn't have the complete employment of "think". The word would have reference to a mode of behaviour. Not until it finds its particular use in the first person does it acquire the meaning of mental activity.

231. I think it is important to remark that the word doesn't have a first person present (in the meaning which is of consequence to us). Or should I say: that its use in the present tense does not parallel that of the verb "feel pain", for instance?

232. One can say "I thought..." if one really did use an expression of thought; but also if these words are, as it were, a development from a germ of thought.

233. Only under quite special circumstances does the question arise[†] whether one spoke *thoughtfully* or not. [Z 95.]

234. The use of a word such as "thinking" is simply far more erratic than it appears at first sight.

It can also be put this way: The expression serves a much more specialized purpose than is apparent from its

form. For the form is a simple, regular structure. If thinking frequently, or mostly goes with talking, then of course there is the possibility that in some instance it does not go with it.

Page 45

235. I'm learning a foreign language and I read sample sentences in a textbook. "My aunt has a beautiful garden." The sentence has the smell of a textbook. I read it and ask myself, "What does 'beautiful' mean in...?", then I think about the case of the adjective.--Now if I tell somebody that my aunt has..., then I don't think about these things. The context in which the sentence stood was completely different.--But wasn't I able to read that sentence in the textbook and at the same time think about my aunt's garden? Certainly. And should I now say that the thought-accompaniment is a different one every time, according as I see the sentence one time as a pure exercise, another time as an exercise accompanied by the thought of a garden, and another time as I simply say it as a piece of information to someone?--And is it impossible that someone should give me this information in the course of a conversation, and that exactly the same thing could occur within him then as when he uses the sentence as a language exercise? Does it matter to me what goes on inside him? Do I realize it?

And how can I write about it at all with any degree of certainty? For while I am doing this, I am not learning a language and I am not giving anybody a piece of information. How, then, can I know what goes on inside a person in such a case? Do I remember what went on inside me in these cases? Nothing of the sort. I only believed I could think myself into these situations. But then I might completely have gone wrong.

And this is the very method that is *always* used in such cases! What one experiences here is merely characteristic of the situation of philosophizing.

Page 45

236. What do I know of what goes on within someone who is reading a sentence attentively? And can he describe it to me afterwards, and, if he does describe something, will it be *the* characteristic process of attention? [Z 90.]

Page Break 46

Page 46

237. What result am I aiming at when I tell someone: "Read attentively!"? That, e.g., this and that should strike him, and he be able to give an account of it.--Again, it could, I think, be said that if you read a sentence with attention you will then be able to give a general account of what has gone on in your mind, e.g. the occurrence of images. But that does not mean that these things constituted attention. [Z 91.]

Page 46

238. What do I do if he tells me that he thought about something entirely different when he read the sentence? What interesting conclusions can I draw from such a piece of information? Well, for instance that this particular matter occupies his mind; that I should not expect that he knows what the material he read was about; that what he read has made no impression on him whatsoever; and things like that.

Therefore it would make no sense if somebody who had had a pleasant conversation^{†1} with me were thereafter to assure me that he had spoken entirely without thinking. But this is not because it contradicts all experience that a person who can speak in this way should do so without thought processes accompanying his speech. Rather, it is because it comes out here that the accompanying processes are of no interest whatsoever to us, and do not constitute thinking. We don't give a damn about his accompanying processes when he engages in a normal conversation with us.

Page 46

239. "It flashed through my mind:..." Now people learn the use of this expression. Hardly ever do we ask anyone: "How did it flash through your mind? Did you say certain words to yourself? Did you see something in your imagination; can you say *in any way* what went on inside of you?"

Page 46

240. If you want to find out how many different things "thought" means, you have only to compare a thought in pure mathematics with a non-mathematical one. Only think how many things are called "sentences"!

Page 46

241. A child does not *have* to first use a primitive expression which we then replace with the usual one. Why shouldn't he immediately use the adult expression which he has heard several times? It really doesn't matter how he "guesses" that this is the right expression, or how he comes to use it. The main thing is that no matter what the preliminaries are, he uses the word the same way adults do: i.e., on

Page Break 47

the same occasions, in the same context. He also says^{†1}: the other person thought...

242. How important is the experience of meaning in linguistic communication? What is important is that we intend something when we utter a word. For example, I say "Bank!" and want thereby to remind someone to go to the bank, and intend "bank" in the one meaning and not in the other.--But intention is no experience.

243. But what makes it different from an experience?--Well it has no experiential content. For the contents (e.g., images) which often go hand in hand with it, are not the intention itself. †2--And yet neither is it a disposition, like knowing. For the intention was present when I said "Bank"; now it is no longer present; but I have not forgotten it.

244. True: It is possible that I was more or less intensely occupied with what I said. And here it is obviously not a matter of having particular experiences while I utter the words. That is, it would be wrong to say: "In the process of uttering the word 'Bank' such and such a thing had to take place if it was really supposed to mean *that*."

245. That it is possible after all to utter the word in isolation, far removed from any intention, 'now with one meaning, now with another', is a phenomenon which has no bearing on the nature of meaning; as if one could say, "Look, you can do *this* with a meaning too".--No more than one could say: "Look at all the things you can do with an apple: you can eat it, see it, desire it, try to form an image of it." No more than it is characteristic of the concept 'needle' and 'soul' that we can ask how many souls can fit on the point of a needle.--We're dealing here, so to speak, with an *outgrowth* of the concept.

246. Instead of "outgrowth of the concept" I could also have said "an annex to the concept".--In the sense that it is also not essential to

people's names that they seem to have the traits of their bearers.--((Quote from Grillparzer.))†1

247. How can the mental state of someone who is giving an order semi-automatically be distinguished from the state in which the order is given *with emphasis*, urgently? "Something different is going on in this person's mind." Think about the purpose of distinguishing. What are the signs of emphasis?

248. If a normal human is holding a normal conversation under such and such normal circumstances, and I were to be asked what distinguishes thinking from not-thinking in such a case--I should not know what answer to give. And I could *certainly not* say that the difference lay in something that goes on or fails to go on while he is speaking. [Z 93.]

249. The boundary-line that is drawn here between 'thinking' and 'not thinking' would run between two conditions which are not distinguished by anything in the least resembling a play of images. For the play of images will always be conceived of as the characteristic of thinking. [Cf. Z 94.]

250. "I said those words, but I wasn't thinking of *anything at all* as I said them." That is an interesting utterance, because the consequences are interesting. You can always suppose that whoever says this had made a mistake in his introspection; but that wouldn't make any difference.

251. But what am I to say now: Did the person who spoke without thought lack an experience? Were the experiences images, for instance?--But if he had lacked them, would this be *of the same interest* to us as that he spoke without thought? Is it the images which interest us in this case? Doesn't his utterance contain a kind of signal of a totally different meaning?

252. Should I say: "If you didn't speak automatically (whatever that may mean) and if you didn't intend something later, and if you didn't change your intention, then you had it when you spoke"?

253. "I didn't mean anything by the sentence. I was just saying it." How remarkable that when I say this although I don't allude to any

experience as I'm speaking, still I am not giving expression to anything dubitable.

It is very noteworthy that *what goes on* in thinking practically never interests us. (But of course I shouldn't say it is noteworthy.) [b: cf. Z 88.]

Page 49

254. The question "What did you mean" and others like it can be used in two ways. In one case we simply demand an explanation of sense or meaning so that we can continue the language-game. In the other we are interested in what happened at the time the sentence was spoken. In the first case we would not be interested in a psychological report such as this: "First I just said it to myself, then I turned to you and wanted to remind you...."

Page 49

255. Did you mean *that*? Yes, it was the beginning of this movement.

Page 49

256. Let's imagine the following case: At 12 o'clock I'm supposed to remind somebody to go to the bank to get money. At 12 I glance at the clock and I say "Bank!" (either facing the person or looking away from him); I might make a gesture which you sometimes make when you suddenly remember something you have to do. If asked "Do you mean the... bank?" I will say "Yes".--If asked "Did you mean the... bank when you were talking?" I'd also say "Yes".--But what if I said "No" to the latter? What information would that give the other person? Possibly that I meant the sentence in a different way when I uttered it, but then wanted to use it for this purpose after all. Well, that can happen. It is also possible that when I glance at the clock I utter the word "Bank" in a queer automatic way, so that when I report "Suddenly I heard myself saying the word without attaching any kind of meaning to it. Only a few seconds later did I remember that you were supposed to go to the bank".--If I had answered that I had meant the word in a different way at first, I would obviously be referring to the time of speaking. And I could also have expressed myself this way: "While speaking I thought of *this* bank, and not of...".--Now the question is: Is this "thinking of..." an experience? One would like to say that usually, and possibly always, it goes with an experience. To say that one thought about *this* thing to which one can now point, which one can describe, etc., is really like saying: This word, this sentence, was the beginning of that train of thought, of that movement. But it is not as if I knew this by subsequent experiences; rather the utterance "As I spoke these words I thought of..." itself attaches to that point of time. And if I were to utter it in the present tense rather than in the past *it would mean something else*.

Page Break 50

Page 50

257. But why do I want to say that thinking is not an *experience*?--One can think of "duration". If I had spoken a whole sentence instead of the single word, I couldn't call one particular point of time in which I was thinking the beginning of my thinking process, nor yet the moment in which it took place. Or, if one calls the beginning and end of the sentence the beginning and end of the thought, then it is not clear whether one should say of the experience of thinking that it is uniform during this time, or whether it is a process like speaking the sentence itself.

Sure, if we are to speak of an experience of thinking, the experience of speaking is as good as any. But the concept 'thinking' is not a concept of experience. For we don't compare thoughts in the same way as we compare experiences. [b: Z 96.]

Page 50

258. One may disturb someone in thinking--but in intending?--But certainly in planning. Also in keeping to an intention, that is in thinking or acting. [Z 50.]

Page 50

259. "Say 'a b c d e' and mean: The weather is fine." Should I say, then, that the experience of pronouncing a sentence in a familiar language is quite different from that of pronouncing signs that are familiar to us, but not in certain meanings? So if I learnt the language in which "a b c d e" meant that of..., should I come bit by bit to have the familiar experience when I pronounced a sentence? Or should I say, as I'm inclined to, that the major difference between the two cases is that in the one I can't move. It is as if one of my joints were in splints, and I were not yet familiar with the possible movements, so that I as it were keep on bumping into things. (Feeling of something soft.) [Cf. Z 6.]

Page 50

260. Suppose I were with someone who spoke this language, and I had been told that "a b c d e" means this and that, and that I should say it because it is polite to do so. So, I would say it with a friendly smile, with a glance out the window. Would that alone not be enough to give me a better understanding of these signs?

Page 50

261. One could speak of a *'feeling for'* something. And in what does my feeling for a sentence I utter consist? It will be said that it consists in what goes on inside me when I speak. I would like to say: In the connections, the tie-ups which I make. For the question is: What happens within me when I have a feeling for something--what makes it a

feeling for the content of this sentence? Why isn't it, e.g., a

Page Break 51

pathological state of excitement in me, which accompanies my speaking? [Cf. Z 124.]

Page 51

262. Can I really say that when I 'unthinkingly' read the sentence in the textbook, something completely different, or simply something different, goes on in me from what goes on when in a different situation I read the sentence comprehendingly? Yes--there are differences. For instance, in a certain situation I shall respond to the same sentence: "So *that's* the way it was?", I shall be surprised, disappointed, expectant, satisfied, etc.

Page 51

263. "Did you think as you read the sentence?"--"Yes, I did think as I read it; every word was important to me." "I was thinking very intensely." A signal.
Did nothing go on in the process? Yes, all sorts of things. But the signal did not refer to *them*.
And yet the signal referred to the time of speaking. [a: Z 92a.]

Page 51

264. James might perhaps say: "I read each word with the feeling appropriate to it. 'But' with the but-feeling," and so on.--And even if that is true--what does it really signify? What is the grammar of the concept 'but-feeling'?--It certainly isn't a feeling just because I call it "a feeling". [Cf. Z 188.]

Page 51

265. How strange, that something has happened while I was speaking and yet I cannot say *what!*--The best thing would be to say it was an illusion, and nothing really happened; and now I investigate the usefulness of the utterance.

Furthermore the question will arise as to the usefulness of referring to a point of time in the past.

Page 51

266. Yes; "While saying these words I thought..." indeed does refer to the time of speaking; but if I am now to characterize the 'process' I cannot describe it as something happening in this stretch of time. I cannot say, e.g., that this or that phase of the process occurred in *this* time segment. So I can *not* describe the thinking process as I can describe speaking itself, for instance. That is why one can't very well call thinking a process. ((Nor an accompaniment of speaking.))

Page 51

267. By 'thinking while you speak' I really should mean that I speak and understand what I say, and not that I speak and understand it later.

Writing is certainly a voluntary movement, and yet an automatic

Page Break 52

one. And of course there is no question of the movements in writing. That is, one feels something, but could not possibly analyze the feeling. One's hand writes; it does not write because one wills, but one wills it to write.

One does not watch it in astonishment or with interest while writing; does not think "What will it write now?". But not *because* one had a wish that it should write *that*. For that it writes what I want might very well throw me into astonishment. [b, c: Z 586.]

Page 52

268. How do we test whether somebody understands what it means to relax his arm muscles, to let his arms go limp? By testing whether they are relaxed when he says he relaxed them (in response to our order, for instance). Now what would we say of a person who is lifting a weight apparently voluntarily, and who tells us that he is not tensing his muscles? In this case we would say he was lying, or suffering from a strange delusion. I don't know whether there are deranged people who declare that their normal movements are involuntary. But if somebody does I would expect him to follow the movements of his arm with his attention in a fashion quite different from the normal one; that is, as he might follow the movement of a pointer on an instrument.

Page 52

269. A child learns to walk, to crawl, to play. It does not learn to play voluntarily and involuntarily. But what makes its movements in play into voluntary movements? What would it be like if they were involuntary?--I could also ask: what makes these movements into a game?--The fact that they are reactions to certain movements, sound, etc., of a grown-up, that they occur in *this* sequence, go together with *these* facial expressions and sounds (laughing, e.g.). [Cf. Z 587.]

Page 52

270. Briefly, if the child executes the movements IN THIS WAY, then we say that they are voluntary. Movements in such syndromes are called "voluntary".

271. I signal to someone with my eyes. Later I can explain what it meant. If I say "At the time I had *this* intention" it is as if I were calling the expression the beginning of a movement. I do not explain the expression with the help of *established* rules, nor by a definition which is to regulate the future use of the signal. I don't say "This signal means *this* to us", nor "In the future it is to mean *this*". Thus I am *not* giving a definition.

272. But now think of the difference it makes if I exclaim "Bank!" in some particular situation, not on my own, but perhaps read it in a history book or a play. I am assuming I read it with *understanding*. Am I still inclined to speak of an intention (I mean of *my* intention) in connection with this word?

273. But can I say that when I am reading, something goes on inside me which is different from what happens in a spontaneous exclamation? No. I know *nothing* about such a difference of processes, although the way I am expressing myself might lead one to infer something like that.

But if someone were to come into the room at the very moment I was reading the exclamation and were to ask me whether I wanted this, or that, I would tell him that I hadn't meant the exclamation that way, but had just been reading something.

274. I said earlier that intention has no content. One can call its content what explains its verbal expression. But it is just that that cannot be said to be a uniform state, lasting from this point in time to that one; e.g., from the beginning of the first until the end of the last word; not can one distinguish phases in it and correlate them with the parts of the verbal expression. But if the sentence were accompanied by a play of images one could do precisely that.

275. The difference between "intend" and "think of the intention".

If I say to myself, "I'm going to end this conversation", then that is presumably the expression of an intention, indeed, of an intention at the moment of its inception. Actually it is the expression of a *decision*. And corresponding to a decision that is an affirmation of an intention, there is also a wavering back and forth between decisions, a wrestling with the decision.

276. When I think to myself, "I can't stand it any more; I want to go!", then I am thinking of an intention. But this is thinking of the outbreak of an intention. Whereas a person who says "I'm planning next year to..." can also be said to be thinking of an intention, but in a completely different sense.

277. One does not say "I know it's raining" simply to report that it is raining; rather this is said if the statement has been called into question; or in response to the question whether I'm sure that it's raining. But then I could also say "It's quite certain: it's raining".

278. I can play a whole series of language-games with a report. One might be: acting according to the report; another one: using the report to test whoever gave it.

But isn't the first language-game the more primitive one, so to speak, the real purpose of a report?

279. It must be remembered that the first person "I believe" could very well exist without the third person.

Why shouldn't a verb have been formed in language which only exists in the first person present? What has led to this, what images, is irrelevant.

280. But what does this mean: "It's raining and I don't believe it" makes sense if I *mean* it as a hypothesis, and does not make sense if I *meant* it as an assertion, or a report?

We have an image of something emanating from the sentence, of something lighting up, if it is intended in the former way, whereas everything remains dark if it is intended in the latter. And there is some truth to this: for if someone says these words to me and I understand them as a hypothesis, then my face might be lighted up with comprehension; but if I take the sentence as a report then I become confused as to its meaning and comprehension escapes me.

"It's raining and I don't believe it" is an assumption, not a report.

281. One would also like to say: The assumption that I believe something is the assumption that I am disposed in a *particular* way. Whereas I should not want to say of the report "I believe..." that it says something about my disposition. Rather it is an utterance of this disposition.

Page 54

282. All that hangs together with this, that one can say "I believe he believes...", "I believe I believed...", but not "I believe I believe...".

Page 54

283. If we were to have an obligatory "I believe" at the beginning of every assertion, "I believe it is so" would mean the same thing as "It is so". But "Suppose I believe it is so" would *not* mean the same thing as "Suppose it is so".

Page 54

284. I have satisfied myself about something and now I know it. One doesn't say "I know that the earth has existed for the past ten minutes"; one does say, however, "It is known that the earth has existed for many thousands of years". And this is not because it is unnecessary to assert something like that.

Page Break 55

Page 55

285. "I know that this path leads over there."

"I know where this path leads to."

In the latter case I am saying that I possess something; in the *former*, I am affirming a fact. In the former case the word "know" could even be dropped. In the latter, one could go on: "But I'm not telling."

Page 55

286. The statement "I know it is so" is followed by the question "How do you know that?", the question asking for evidence.

Page 55

287. In the language-game of reporting there is the case of the report being called into question, of one's assuming that the reporter is merely conjecturing what he reports, that he hasn't ascertained it. Here he might say: I *know* it. That is: It is not mere surmise.--Should I say in this case that he is telling the certainty, the certainty he feels about his report, to me? No, I wouldn't like to say that. He's simply playing the language-game of reporting, and "I know it" is the form of a report.

Page 55

288. Can one only know what is true? Well, one does say "I believe I know it", and here there is no uncertainty attached to the belief. This does not mean: "I'm not certain: Do I know it, or don't I?"

Page 55

289. Some will say that my talk about the concept of knowledge is irrelevant, since this concept as understood by philosophers, while indeed it does not agree with the concept as it is used in everyday speech, still is an important and interesting one, created by a kind of sublimation from the ordinary, rather uninteresting one. But the philosophical concept was derived from the ordinary one through all sorts of misunderstandings, and it strengthens these misunderstandings. It is in no way interesting, except as a warning.

Page 55

290. Again, you must not forget that "A contradiction doesn't make sense" does not mean that the sense of a contradiction is nonsense.--We exclude contradictions from language; we have no clear-cut use for them, and we don't want to use them. And if "It's raining but I don't believe it" is senseless, then again that is because an extension along certain lines leads to this technique. But under unusual circumstances that sentence could be given a clear sense.

Page 55

291. If there were such a thing as 'automatic' speech, then we couldn't dispute such an utterance, or try to prove a mistake on

Page Break 56

the part of one who speaks it. Thus we would not play the same language-games with automatic speech as we do with the usual kind.

Page 56

292. Calling a mode of speech "automatic" produces the image of something without inflection, something mechanical. But that isn't at all important to us. One need only assume that *two* people are talking through one mouth. We must then treat what was said as the utterance of two people. Thus both sentences could be spoken with the intention of giving a report. And then the only question would be, how I should react to these reports.

Page 56

293. On the one hand it can be said that black and white can coexist in grey; on the other hand it will be said: "But where there is grey, there is, of course, neither black nor white. What is grey is of course not really white."

Page 56

294. But how about "light red" and "dark red"? Will one want to say that they can co-exist somewhere? Or lilac and purple?--Well, suppose that we were constantly surrounded by very specific shades of light and dark blue, and that we could not (contrary to what is actually the case) easily produce any shade of colour we chose. But under certain circumstances we would be able to mix the light blue substance with the dark blue one, and then we would arrive at an unusual shade of colour which we would then perceive as a mixture of light blue and dark blue.

Page 56

295. "But would our concepts of colour then be the same as the ones we have today?" They would be very similar. Very much like the relation of number concepts of peoples who can only count to five, and ours.

Page 56

296. One can say: Whoever has a word explained by reference to a patch of colour only knows *what* is meant to the extent that he knows *how* the word is to be used. That is to say: there is no grasping or understanding of an object, only the grasping of a technique.

On the other hand, we would certainly say that grasping or comprehending an object is possible *before* understanding a technique, for we can simply give someone the order "Copy *this!*" and then he can copy the colour, or the shape and size, or only the shape, or the colour, but not the exact shade, etc. And here copying does what in the case of a body is done by taking one in one's hand.--It is as if we

Page Break 57

could pick out the meaning, or the colour, perhaps, with a particularly refined pair of mental tweezers, without catching hold of anything else.

Page 57

297. The understanding, I say, catches hold of *the one object*; and then we speak of *it* and its qualities according to its nature.

Page 57

298. But how do I know that your mind catches hold of the same object as mine? Well, for instance by the very way you react to my command, e.g. "Copy the colour". But in this case, you will say, we can only recognize what is essential to his reaction by having him copy more and more colours. Presumably this means that after a few such reactions I will be able to see others in advance; and this I explain by saying: Now I know "*what*" he is actually copying. The colour or the form, for example--but there are more such *whats* than we are usually inclined to assume, i.e., concepts can also be formed with which we are quite unfamiliar.

It may also be that I do foresee his reactions of copying after a few have been given, and that I can count on them--i.e., say that we have now understood one another.--But then in a somewhat different situation I nevertheless get a surprise.--And what shall I now say: That I had been misunderstanding him the whole time?, or that I partly misunderstood him? If you think about catching hold of an object you will perhaps say the former, in accordance with the picture that he just had *not* caught hold of the object that I thought he had. But if we think about methods of using words, then we shall say that here we have similar, but not identical, methods.

Page 57

299. Now here it is certainly important that a technique has a physiognomy for us. That we can speak, for example, of uniform and non-uniform uses.

Page 57

300. In one sense knowing is to have learned and not forgotten. In this way it hangs together with memory.--So now I can say: "I know what 97×78 is", or "I know that 97×78 is 432". In the first case, I would say, I tell someone that I can do something, that I possess something; in the second I simply assure the other person that 97×78 is 432. For doesn't " 97×78 is quite definitely 432" mean *I know* it is? The matter can also be put this way: The first sentence is by no means an arithmetical one, nor can it somehow be replaced by an arithmetical one; but an arithmetical sentence could be used in place of the second one. [Cf. Z 406.]

Page Break 58

Page 58

301. The difference is as follows: In the sentence "I know how it is" the "I know" cannot be omitted. The sentence "I know it is this way" can be replaced by "It is this way".

Page 58

302. "It's going to rain."--"Do you believe it's going to rain?"--"I know it's going to rain." Does the third sentence say more than the first? It is a repetition of the first and a rejection of the second.

303. But isn't there a phenomenon of knowing, as it were quite apart from the sense of the phrase "I know"? Is it not remarkable that a man can *know* something, can as it were have the fact within him?--But that is a wrong picture.--For, it is said, it's only knowledge if things really are as he says. But that is not enough. It musn't be just an accident that they are. For he has got to know that he knows: for knowing is a state of his own mind; he cannot be in doubt or error about it--apart from some special sort of blindness. If then knowledge *that* things are so is only knowledge if they *really* are so; and if knowledge is in him so that he is infallible about its being knowledge; in that case, he is also infallible about things being the way knowledge knows them; and so the fact which he knows must be within him just like the knowledge.

So: when I say, without lying: "I know that it is so", then only through a special sort of blindness can I be wrong. [Z 408a, c.]

304. Does "not seeing a picture IN THIS WAY" mean: *seeing it differently?*

305. Imagine the following: I am shown a picture-puzzle; I see trees, people, etc. in it. I examine it and suddenly I see a figure in the tree-tops. Looking at it afterwards, I no longer see those lines as branches, but as parts of the figure. Then I place the picture in my room, where I see it every day, and usually I forget about the second interpretation, and so now it is simply a forest. I see it in the same way as any other picture of a forest. (You see the difficulty.)--Then one day I say of the picture: "It's been such a long time since I've seen it as a picture-puzzle, I've almost forgotten that it is one." Here one can ask, of course: "Well how *did* you see it?", and I shall say, "Well, as trees...", and that is quite right too; but did I therefore not only see the picture and know what it portrayed, but also perceive it according to a certain interpretation? I would rather say: Up until now they've always just been trees to me; I've never thought about the picture in any other way.

306. Anyone who regrets something thinks about it. Is regret therefore a kind of thought? Or a colouring of thought?

There are regretful thoughts just as there are fearful ones, for instance. But if I say "I regret it" am I saying "I have regretful thoughts"? No, because somebody who doesn't regret it at the moment could say this too. But couldn't I say, "I think of it with regret", instead of "I regret it"?

307. What is it that interests me about someone else's regret? His attitude toward his action. The signs of regret are the signs of aversion, of sadness. The expression of regret refers to the action.

Regret is called a pain of the soul because the signs of pain are similar to those of regret.

But if one wanted to find an analogy to the place of pain, it would of course not be the mind (as, of course, place of bodily pain is not the body), but the *object* of regret. [c: Z 511.]

308. Why can a dog feel fear but not remorse? Would it be right to say "Because he can't talk"? [Z 518.]

309. Only someone who can reflect on the past can repent. But that does not mean that as a matter of empirical fact only such a one is capable of the feeling of remorse. [Z 519.]

310. There is nothing that astonishing about a certain concept only being applicable to a being that, e.g. possesses a language. [Z 520.]

311. The treatment of all these phenomena of mental life is not of importance to me because I am keen on completeness. Rather because each one casts light on the correct treatment of *all*. [Z 465.]

312. When he first learns the names of colours--what is taught him? Well, he learns, e.g., to call out "red" on seeing something red.--But is that a correct description; or ought it to have gone: "He learns to call 'red' *what we too* call 'red'"? Both descriptions are right.

What differentiates this from the language-game "How does it strike you?"?

But someone might be taught colour-vocabulary by being made to look at white objects through coloured spectacles. What I teach him, however, must be a *capacity*. So he *can* now bring something red at an

order; or arrange objects according to colour. But what then is something red? "Well *that* (pointing)." Or should he

have said, "*That*, because most of us call it 'red'"? Or simply "*That* is what most of us call 'red'"?

This information doesn't help us at all. The difficulty we sense here with respect to "red" reappears for "same". [Z 421--up to the sentence "Well *that* (pointing)".]

Page 60

313. For I describe the language-game "Bring something red" to someone who can himself already play it. Others I might at most *teach it*. (Relativity.) [Z 432.]

Page 60

314. Here we have a profound and important point; I wish I knew how to express it unambiguously. Somehow one is deceived as to the purpose of the description. Or: one wants to go on giving reasons because he misunderstands the function of giving a reason.

Page 60

315. Why doesn't one teach a child the language-game "It looks red to me" from the first? Because it is not yet able to understand the rather fine distinction between seeming and being? [Z 422.]

Page 60

316. The red visual impression is a new *concept*. [Z 423.]

Page 60

317. The language-game that we teach him then is: "It looks to me..., it looks to you...". In the first language-game a person does not occur as perceiving subject. [Z 424.]

Page 60

318. You give the language-game a new joint. Which does not mean, however, that now it is always used.

The language-game "What is that?"--"A chair."--is not the same as: "What do you take that for?"--"It might be a chair." [a: Z 425; b: Z 417.]

Page 60

319. In the beginning we do not teach the child "It's probably a chair", but "That's a chair". Don't fancy for a moment that the word "probably" is left out because it is still too difficult for the child to understand, that things are simplified for the child; that therefore he is taught something that is not *strictly* right.

Page 60

320. One speaks of a feeling of conviction because there is a *tone* of conviction. For the characteristic mark of all 'feelings' is that there is expression of them, i.e. facial expression, gestures, of feeling. [Z 513.]

Page Break 61

Page 61

321. James says it is impossible to imagine an emotion or a mood without the corresponding bodily sensations (of which it is composed). If you imagine the latter absent then you can see that you are thereby abolishing the very existence of the emotion. This might happen in the following way: I imagine myself sorrowing, and now in the imagination I try to picture and to feel myself rejoicing at the same time. To do that I might take a deep breath and imitate a beaming face. And now indeed I have trouble forming an image of sorrow; for forming an image of it would mean play-acting it. But it does not follow from this that our bodily feeling at that point is sorrow, or even something like it.--To be sure, a person who is sorrowful cannot laugh and rejoice convincingly, and if he could, what we call the expression of sorrow would not really be that, and rejoicing would not be the expression of a different emotion.--If the death of a friend and the recovery of a friend equally caused us to rejoice or--judging by our behaviour--both caused us sorrow, then these forms of behaviour would not be what we call the expressions of joy or sorrow. Is it clear *a priori* that whoever imitates joy will feel it? Couldn't the mere attempt to laugh while one was feeling grief bring about an enormous sharpening of the grief?

Page 61

322. Yet still I mustn't forget that joy goes along with physical well-being, and sadness, or at least depression, often with being physically out of sorts.--If I go for a walk and take pleasure in everything, then it is surely true that this would not happen if I were feeling unwell. But if I now express my joy, saying, e.g., "How marvellous all of this is!"--did I mean to say that all of these things were producing pleasant physical feelings in me?

In the very case where I'd express my joy like this: "The trees and the sky and the birds make me feel good all over"--still what's in question here is not causation, nor empirical concomitance, etc. etc.

Page 61

323. One does say: "Now that he's well again I breathe easier", and one breathes a deep sigh of relief.

Possibly one could be sad because he is crying, but of course one is not sad *that* he is crying. It would after all be possible that people made to cry by application of onions would become sad; that they would either become generally depressed, or would start thinking about certain events, and then grieve over them. But then the *sensations* of crying would not thereby have turned into a part of the 'feeling' of grief.

324. If someone behaves in such-and-such a way under such-and-such circumstances, we say that he is sad. (We say it of a dog too.) To this extent it cannot be said that the behaviour is the *cause* of the sadness; it is its symptom. Nor would it be beyond cavil to call it the effect of sadness.--If he says it of himself (that he is sad) he will not in general give his sad face as a reason. But what if he said: "Experience has taught me that I get sad as soon as I start sitting about sadly, etc." This might have two different meanings. Firstly: "As soon as, following a slight inclination, I set out to carry and conduct myself in such-and-such a way, I get into a state in which I have to persist in this behaviour." For it might be that a toothache got worse by groaning.--Secondly, however, that proposition might contain a speculation about the cause of human sadness. The content being, perhaps, that if you could somehow or other produce certain bodily states, you would make the man sad. But here arises the difficulty that we should not call a man sad, if he *looked* and *acted* sad in all circumstances. If we taught such a one the expression "I am sad" and he constantly kept on saying this with an expression of sadness, these words, like the other signs, would have lost their normal sense. [Z 526.]

325. I should almost like to say: One no more feels sorrow in one's body than one feels seeing in one's eyes. [Z 495.]

326. To begin by teaching someone "That looks red" makes no sense. For he must say that spontaneously once he has learnt what "red" means, i.e. has learnt the technique of using the word. [Z 418.]

327. Any explanation has its foundation in training. (Educators ought to remember this.) [Z 419.]

328. "So these concepts are valid only for the *total* human being?" No, for some have their application to animals too.

329. "Whoever generally acts this way and then sometimes that way, is described as..." That is a legitimate kind of explanation of a word.

330. We are inclined to imagine the matter as if a visual *sensation* were a new *object* which the child gets to know, after he has learned the first primitive language-games with visual observations. "It looks red to

me."--"And what is red like?"--"Like *this*." Here the right paradigm must be pointed to. [From "It looks red to me.": Z 420.]

331. If I have learned to carry out a particular activity in a particular room (putting the room in order, say) and am master of this technique, it does not follow that I must be ready to describe the arrangement of the room; even if I should at once notice, and could also describe, any alteration in it. [Z 119.]

332. "This law was not given with such cases in view." Does that mean it is senseless? [Z 120.]

333. One could imagine a concept of fear, for instance, that had application only to beasts, and therefore pertained only to behaviour.--But you don't want to say that such a concept would have no use. [Z 524, first two sentences.]

334. Can one say that there is a *similarity* between the emotion and its expression, insofar as both are excited, for example? (I think Köhler said something like that.) And how does one know that the emotion itself is excited? The person who feels it notices it and says so.--And if someone were one day to say the opposite?--"Be honest now, and say whether you don't really recognize your inner excitement!"--How did I ever learn the meaning of the word "excitement"?

335. The misconception that this word means something internal *as well as* something external. And if any one denies that, he is misinterpreted as denying inner excitement. (Temporal and timeless sentences.)

336. Imagine that a child was quite specially clever, so clever that he could at once be taught the doubtfulness of the existence of all things. So he learns from the beginning: "That is probably a chair."

And now how does he learn the question: "Is it also really a chair?"? [Z 411.]

Page 63

337. Am I doing child psychology?--I am making a connection between the concept of teaching and the concept of meaning.[Z 412.]

Page Break 64

Page 64

338. One man is a convinced realist, another a convinced idealist and teaches his children accordingly. In such an important matter as the existence or non-existence of the external world they don't want to teach their children anything wrong.

What will the children be taught? Also to say: "There are physical objects" or the opposite?

If someone does not believe in fairies, he does not need to teach his children "There are no fairies": he can omit to teach them the word "fairy". On what occasion are they to say: "There are..." or "There are no..."? Only when they meet people of the contrary belief. [Z 413.]

Page 64

339. But the idealist will teach his children the word "chair" after all, for of course he wants to teach them to do this and that, e.g. to fetch a chair. Then where will be the difference between what the idealist-educated children say and the realist ones? Won't the difference only be one of the battle cry? [Z 414.]

Page 64

340. For doesn't the game "That is probably a..." begin with disillusion? And can the first attitude of all be directed towards a possible disillusion? [Z 415.]

Page 64

341. "So does he have to begin by being taught a false certainty?"

There isn't any question of certainty or uncertainty yet in their language-game. Remember: they are learning to *do* something. [Z 416.]

Page 64

342. So how does the doubt get expressed? That is: in a language-game, and not merely in certain *phrases*. Maybe in looking more closely; and so in a fairly complicated activity. But this expression of doubt by no means always makes sense, nor does it always have a point.

One simply tends to forget that even doubting belongs to a language-game.

Page 64

343. How does it come about that doubt is not subject to arbitrary choice?--And that being so--might not a child doubt everything because it was so remarkably talented?

A person can doubt only if he has learnt certain things; as he can miscalculate only if he has learnt to calculate. In this case it is indeed involuntary. [a: Z 409; b: Z 410.]

Page 64

344. If I have any doubts that this is a chair, what do I do?--I look at it and feel it on all sides, and so forth. But is this way of acting always an expression of doubt? No. If a monkey or a child were to do this it

Page Break 65

wouldn't be. Only someone who is acquainted with such a thing as a 'reason for doubt' can doubt.

Page 65

345. I can easily imagine that a particular *primitive* behaviour might later develop into a doubt. There is, e.g., a kind of primitive investigation. (An ape who tears apart a cigarette, for example. We don't see an intelligent dog do such things.) The mere act of turning an object all around and looking it over is a primitive root of doubt. But there is doubt only when the typical antecedents and consequences of doubt are present.

Page 65

346. "It tastes like sugar." One remembers exactly and with certainty what sugar tastes like. I do not say "I believe sugar tastes like this." What a remarkable phenomenon. It just is the phenomenon of memory.--But is it right to call it a remarkable phenomenon?

It is anything but remarkable. That uncertainty is not by a hair's breadth more remarkable than uncertainty would be. For what is remarkable? My saying with certainty "This tastes like sugar", or its then really being sugar? Or that other people find the same thing?

If the certain recognition of sugar is remarkable, then the failure to recognize it would be less so. [Z 660.]

Page 65

347. If people were (suddenly) to stop agreeing with each other in their judgments about tastes--would I still say: At any rate, each one knows what taste he's having?--Wouldn't it then become clear that this is nonsense?

348. Confusion of tastes: I say "This is sweet", someone else "This is sour" and so on. So someone comes along and says: "You have none of you any idea what you are talking about. You no longer know at all what you once called a taste." What would be the sign of our still knowing? [Z 366.]

349. But might we not play a language-game even in this 'confusion'?--But is it still the earlier one?--[Z 367.]

350. But there's a paradox here! Is the reliability of my expression of my taste to depend on changes in the outside world?--The important thing here is surely the sense of the judgment, not its usefulness. Here we see the relation to the original language-game of perception.

351. "It tastes exactly like sugar." How is it I can be so sure of this? Even if it turns out wrong.--And what astonishes me about it? That I bring the concept 'sugar' into so *firm* a connection with the taste sensation. That I seem to recognize the substance sugar directly in the taste.

But instead of the expression "It tastes exactly..." I might more primitively use the exclamation "Sugar!" And can it be said that 'the substance sugar comes before my mind' at the word? How does it do that? [Z 657.]

352. Can I say that this taste brought the name "sugar" along with it in a peremptory fashion? Or the picture of a lump of sugar? Neither seems right. The demand for the concept 'sugar' is indeed peremptory, just as much so, indeed, as the demand for the concept 'red' when we use it to describe what we see. [Z 658.]

353. I remember that sugar tasted like this. The experience returns to consciousness. But, of course: how do I know that this was the earlier experience? Memory is no more use to me here. No, in those words, that the experience returns to consciousness..., I am only transcribing my memory, not explaining it.

But when I say "It tastes exactly like sugar", in an important sense no remembering takes place. So I do *not have grounds for* my judgment or my exclamation. If someone asks me "What do you mean by 'sugar'?"--I shall indeed try to show him a lump of sugar. And if someone asks "How do you know that sugar tastes like that?" I shall indeed answer him "I've eaten sugar thousands of time[[sic]]"--but that is not a justification that I give myself. [Z 659.]

354. "Self-observation tells me that I believe that--but observation of the external world that it is not so."

355. Let us now assume I've seen an F which someone has written like this: . †1 And assume that I always *took* it for a mirror-F; that is, I assumed a *certain* connection between his letter and the regular one. Now you point out to me that this is *not* the connection that exists,

but rather there is a different one (that of the lines moved around). I understand this and now I say: "Well it certainly does look different." If I'm asked "*How* different?" I might say: "Earlier it looked clumsy, but now it looks bold and energetic." [Cf. Z 208.]

356. Suppose †1 someone had always seen faces with only *one* expression, say a smile. And now, for the first time, he sees a face changing its expression. Couldn't we say here that he hadn't noticed a facial expression until now? Not until the change took place was the expression meaningful; earlier it was simply part of the anatomy of the face.--Is that the way it is with the aspect of the letter? Expression could be said to exist only in the play of the features.

357. So how a letter appears to me depends on whether it strictly follows the norm or whether and how it deviates from the norm. Thus it is understandable that it makes a difference whether we know only one explanation for the shape of a letter, or two.

358. For how could I see that this posture was hesitant before I knew that it was a posture and not the anatomy of the animal? [Cf. *PI* II, xi, p. 209b.]

359. The question now is: If one can see a figure according to an interpretation, does one see it according to an

interpretation *every* time? And is there a well-defined difference between seeing which is not connected to any interpretation, and that which is?

Page 67

360. I mean: Seeing a figure with this interpretation is a kind of thinking of the interpretation. For should I say that it is possible to see this as a mirror-F without at the same time thinking about the special *relationship* which the word "mirror-F" signifies? But I see an interpretation and an interpretation is a thought.

Page 67

361. One could make a *rough* copy of a picture-puzzle before and after one put it together, and then a mistake made in copying the first aspect will be different from the mistake made in copying the second. So I could say: "Before I solved it, I saw something like *this* (and I draw a forest)--after I solved it, something like *this*" (and then I draw a man in the tree-tops).

Page Break 68

Page 68

362. You must bear in mind that in the most important cases, what someone sees gets its impression in a report about the object perceived. And this kind of report, of course, includes spatial announcements.†1--Now what is it like, if someone has to give a report about what he sees on a flat surface, when the drawing on it has the character of a picture-puzzle? First of all, so far as describing what he sees on the surface in spatial terms, he can give such a description; indeed, that is perhaps the only kind of description he can give.

Page 68

363. An important piece of information will be, for instance: "Nothing has changed the whole while." This report is based on continuous observation.

Page 68

364. When I solve the picture-puzzle, I discover something about the picture itself. For example, that a ship was hidden by this camouflage. Perhaps I want secretly to tell someone what a certain person looks like, and I hide my message, his portrait, in a picture-puzzle.

Page 68

365. If I were to call the figure an aid to thought, I could say I see it as *this* aid to thought.

Page 68

366. What a queer question it is, whether I musn't have *thought* of N. N.--when suddenly I saw his face in that of his son! Of course my question is not: Mustn't I have thought of him *simultaneously* with having that image of him; rather, it is whether having that image of him wasn't a kind of thinking of him? But how does one decide that?

For instance I say "I was just thinking whether he has arrived in...". This thought is expressed in a sentence. That other one perhaps in an exclamation.

Page 68

367. Can I see his father's face in his and yet not *think* of his father at the same time? Seeing his father's face in his clearly was a kind of imagining of that face. And now we must remember that one does not *recognize* the image of a man as an image of him.

Page 68

368. Remember also that you cannot use a picture (or a model) to represent the shifting of the gaze! And wouldn't the impression that that produces very naturally be counted as part of the visual

Page Break 69

impression? The aspect will, or can be expressed in the way I copy the figure, and thus in *one* sense, it is in the copy after all. Furthermore I will portray a face differently according to my *interpretation* of it, even though the photograph shows the same thing each time. So here again there's reason to speak of "seeing".

Page 69

369. The fact that I produce a different copy (a different result) accords with the concept of the visual state. The fact that I produce the same copy, but in a *different* way--by drawing the lines in a different sequence--points toward the concept of *thinking*.

Page 69

370. What justifies his use of "seeing" here? Or is there any justification and is it merely a linguistic blunder? Or is it solely justified by the fact that I too am inclined to say: "Now I see it as this", "Now I see it as that"? That could be. But I am absolutely disinclined to assume that; I feel I *have* to say "I see something". But what is that supposed to mean?--I *learned* the word "to see", after all. What fits is not the *word*, the sound, or the written image. It's the use of

the word which forces on me the idea that I *see* this.

What I have learned about the use of the word must be forcing me to use the word here.

Page 69

371. "That *is* what it *is* to see something--", I should like to say. And that's really the way it is: the situation is exactly like that in which the word is used elsewhere;--except the technique is somewhat different here.

Page 69

372. The use of the word "see" is in no way a simple one.--Sometimes we think of it as a word for an activity and then it is hard to *put your finger on* the action.--Thus we think of it as simpler than it really is, conceiving it as drinking something in with one's eyes, as it were. So that if I drink something in with my eyes, then there can be no doubt that there's something I'm seeing (unless I am deceived by prejudices).

Page 69

373. One could say: I see the figure now as the limit of this series, now as the limit of that. This *value* could be the limit of various functions.

Page 69

374. In a certain sense the figure can always *be* what I see it as, even if it is not "visible" in the other sense. For, depending on the way it's used, or the way it arises, a figure can be the limit of different series.

Page Break 70

A triangle can really be used to represent a mountain, or as an arrow, in order to point in *this* direction, etc. etc. Thus the description of the aspect is always a correct description of visual perception.

Page 70

375. Take a figure, say a written symbol; it may be the symbol correctly written, or there are various ways in which it may be faulty. And there are aspects corresponding to these ways of taking the figure.--Here there's a very close similarity with the experience of meaning when one utters an isolated word.

Page 70

376. It is copied differently--but the copy is the same.

Page 70

But I want to say: If something else is *seen*, the *copy* must be different.

Page 70

377. What, for example, is a copy of 'the schematic cube'? A drawing, or a solid object? And why only the former?! And if a solid object is a copy, what kind of an object: a solid angle, a solid cube, a wire frame?

Page 70

378. If I tell someone "Now I see the figure as..." then I am providing him with some information *similar* to that given in visual perception, but also similar to that of a way of taking, or an interpretation, or a comparison, or a knowing.

Page 70

379. "Now I see a white cross on a black ground and then a black cross on a white ground." But what is this: a white cross on a black ground? Do explain! And what is a black cross on a white ground? Surely you can't give the same explanation for both! And yet there must be an explanation!

The explanation could go something like this: "A white cross on a black ground is something like *this*--" and now a figure would follow. But of course this must *not* be the ambiguous one. Thus, instead of saying, "I see the figure now as a white cross on..., now as...", one can also say: "I see the figure now in *this* way (and then the figure follows), now in *this* way (and a different figure follows)." And if the first sentence was permissible then so was this one.

Page 70

380. And doesn't that mean that each of the two figures was a *kind* of copy of the ambiguous figure?

Page Break 71

Page 71

381. On the one hand these two representations are copies of what was seen, but on the other there is still need for a conceptual explanation.--For instance, if I see the figure of a cross†1  now as a cross lying down, now as standing up, now as a diagonal cross set up askew--what are the corresponding copies?

A cross lying down is one which was layed on its side but should stand up. So the copy will be something shaped like a cross, and about which we know which it is--lying down or standing up. Therefore it would also be possible to use as a copy a picture in which the shape of a cross appears, playing this or that role. That is, there is a picture which brings to expression what I see as an aspect. And this makes the aspect similar to something visually perceived.

382. Or: In the same way as a picture tells us what is perceived, there is a picture that has a *similar* representing role in relation to the aspect. Imagine a painting of a descent from the cross, for instance. What would that be to us, if we didn't know which *movements* were captured here? The picture shows us these movements and yet it does not. (The picture of the cavalry-attack, when the viewer doesn't know that horses don't stop in those positions.)

383. "What I see looks like *this*." Imagine this said by someone who is looking at a galloping horse and then, as a copy, uses a stuffed horse *standing* in a galloping position! Wouldn't the right copy be a galloping horse?

384. Now--do I see a *thought* before me along with the aspect? Is a thought before me along with the *painting*? (For of course the figure which is seen as this or that is like a part of a painting which by itself doesn't yet make any sense.)

385. It is possible to describe a painting by describing *events*; indeed that's the way it would be described in almost every instance. "He's standing there, lost in sorrow, she's wringing her hands..." Indeed, if you could not describe it this way you wouldn't understand it, even if you could describe the distribution of colour on its surface in minute detail. ((Picture of the man ascending the mountain.))

386. So you see it as if you knew *that* about it.

And if this seems a foolish way of putting it, then it must be kept in mind that the *concept* of seeing is modified by it.

387. But can I also say: "He would see the picture (of the battle, for instance) differently, if he didn't know what was going on here"? How would this come out?! He would not talk about the picture in the same way we do, and he would not say: "You can positively see these horses charging", or "That's not the way a horse runs!" etc. He would not infer many things from the picture that we do.

388. We could resolve, of course, to call what we now call "seeing the figure as...", "*conceiving*" it as this or that.--If we did that, the problems of course would not disappear. Rather, we would then study the use of "*conceiving*", and in particular we would study the peculiarity that this *conceiving* is something stationary, a state that *now* begins and *now* ends.

389. It seems to me--I might say--as if I should be able to reproduce this conception by means of a *picture* of the figure that I am looking at.--And that, indeed, is the way it really is: I can say that the picture someone makes of an object expresses a conception of the object. Quite as one can say: Hear this theme like this..., and play it correspondingly.

390. It is seeing, *insofar as...*

It is seeing, only *insofar as...*

(That seems to me to be the solution.)

391. In this way, however, the aspects which are, so to speak, visual interpretations of the figure differ from the aspects of the three-dimensional appearance. For a figure can be *taken* for a solid object. And even if there's no question of such a deception, the statement "Now I see this figure as a pyramid" tells us something different, and has different consequences, from the statement "Now I see the figure as a black cross on a white ground, etc.". (The consequences of seeing three-dimensionally in descriptive geometry.) But the connection between the aspect and thinking also seems to be changed, or dissolved. For isn't the copy which shows someone else how I see the figure different? And one mustn't forget that the meaning of the word "copy" varies throughout this discussion.

392. "It is as if our concepts involved a scaffolding of facts."

That would presumably mean: If you imagine certain facts

otherwise, describe them otherwise, than the way they are, then you can no longer imagine the application of certain

concepts, because the rules for their application have no analogue in the new circumstances.--So what I am saying comes to *this*: A law is given for human beings, and a jurispudent may well be capable of drawing consequences for any case that ordinarily comes his way; thus the law evidently has its use, makes sense. Nevertheless its validity presupposes all sorts of things, and if the being that he is to judge is quite deviant from ordinary human beings, then, e.g., the decision whether he has done a deed with evil intent will become not difficult but simply impossible. [Z 350.]

Page 73

393. "If humans were not in general agreed about the colours of things, if disagreements were not exceptional, then our concept of colour could not exist." No:--our concept *would* not exist. Does that mean, therefore, that what is conceivable as a rule does not have to be conceivable as an exception? [Z 351--to "Does that mean".]

Page 73

394. It is like the following case: I have learned how to express the results of experiments by means of a curve. If the points are situated like *this*†1, I will know more or less what kind of curve to draw, and I will be able to use it to draw further conclusions from the experiments. But if the points are placed like *this*†2, then what I have learned will leave me in the lurch, for I will no longer know what line to draw. And if I met people who drew a curve through this constellation of points without using any method I could understand and without hesitation, then I shouldn't be able to imitate their technique. But suppose that I should see that they acknowledge *some* plausible line or other as the right one, and that this line then serves them as the basis for further inferences; and if these inferences conflicted, as we should say, with experience, and these people were somehow to make light of it--then I would say that this indeed is no longer the technique I know of, but is one that, although "outwardly" similar, is in

Page Break 74

essence completely different. But if I say that, in using the words "outwardly" and "essence" I am passing judgment.

Page 74

395. What does it mean to say: "But that's an utterly different game!" How do I use this sentence? As information? Well, perhaps to introduce some information in which differences are enumerated and their consequences explained. But also to express that just for that reason I don't join in here, or at any rate take up a different attitude to the game.[Z 330.]

Page 74

396. If I said "I wouldn't any longer call it...", this really means: the scales are tipping--I've taken up a different position toward the thing.

Page 74

397. I could also say: "I can no longer communicate with these people."

Page 74

398. Once I said that there might be a concept which, to the left of a certain dividing line, would correspond to our 'red', and to the right, would correspond to our 'green'. And it appeared to me then and still does, that I might be able mentally to enter this conceptual world, and that indeed I might be inclined to call the red that lies on one side of the line the same thing as green on the other. (Indeed, this actually happens to me, particularly when there is a fairly dark red and a fairly dark green.) It is as if, in such a world, I would not be disinclined to call the green merely an aspect of the red, and as if what I call "colour" went further unaltered, and only the "shading" altered. Thus there would be an inclination, in this situation, to employ a mode of expression which used the same adjective for green and red, along with a modifier such as "shaded"/"unshaded". "But are you really going to tell me then that we're not dealing with two different colours?" I want to say: I see enough similarity between this way of talking and the usual one so that I could very easily accept this way, under certain circumstances.--But then wouldn't people see the similarity or resemblance which we see; i.e., between green to the left and (our usual) green to the right?--What if they said that these two colours were "outwardly similar"? I imagine the situation to be similar to this one: In the drawing†1:

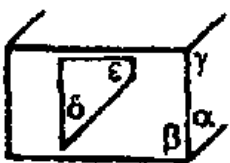

I can call the angles α , β , γ equal to each other, even though they are outwardly unequal; and I can call angles $\delta + \alpha$, as well as $\epsilon + \gamma$ unequal, even though they are outwardly equal.

Page Break 75

Page 75

399. I could also say: the red to the left and the green to the right are of the same nature, but are different manifestations of it.

Page 75

400. But in all of this I have produced a confusion. The important thing about the matter was surely to show that one can go on in a sequence (say of numbers) in such a way that according to *our* concepts he stops following the old law of the series, and continues on following a new one; but that according to another conception, the law of the series does *not* change, but that what appears to be a change is explained by a change in circumstances.

Page 75

401. But what this really amounts to is that *consistently* following a series can only be shown by *example*.

Page 75

402. And here one is tempted again and again to talk more than still makes sense. To continue talking where one should stop.

Page 75

403. I can tell someone: "*This* number is the right continuation of this sequence"; and in doing this I can bring it about that for the future he calls the "right continuation" the same thing I do. That is, I can teach him to continue a series (basic series) without using any expression of the 'law of the series'; rather, I am forming a substratum for the meaning of algebraic rules, or what is like them. [Cf. Z 300.]

Page 75

404. He must go on like this *without a reason*. Not, however, because he cannot yet grasp the reason but because--in *this* system--there is no reason. ("The chain of reasons comes to an end.") And the *like this* (in "go on like this") is signified by a number, a value. For at *this* level the expression of the rule is explained by the value, not the value by the rule. [Z 301.]

Page 75

405. For just where one says "But don't you see...!" the rule is no use, it is what is explained, not what does the explaining. [Z 302.]

Page 75

406. "He grasps the rule intuitively."--But why the rule? Why not how he is to continue? [Z 303.]

Page 75

407. "Once he has seen the right thing, seen the one of infinitely many references which I am trying to push him towards--once he has got hold of it, he will continue the series right without further ado. I grant that he can only guess (intuitively guess) the reference that I

Page Break 76

mean--but once he has managed that the game is won."--But this 'right thing' that I mean does not exist. The comparison is wrong. There is no such thing here as, so to say, a wheel that he is to catch hold of, the right machine which, once chosen, will carry him on automatically. It could be that something of the sort happens in our brain but that is not our concern. [Z 304.]

Page 76

408. "Do the same." But in saying this I must point to the rule. So its *application* must already have been learnt. For otherwise what meaning will its expression have for him? [Z 305.]

Page 76

409. To guess the meaning of a rule, to grasp it intuitively, could surely mean nothing but: to guess its *application*. And that can't now mean: to guess the *kind* of application, the *rule* for it. Nor does guessing come in here. [Z 306.]

Page 76

410. I might, e.g., guess what continuation will give the other *pleasure* (by his expression, perhaps). The application of a rule can be guessed only when one can already choose one among different applications. [Z 307.]

Page 76

411. We might in that case also imagine that, instead of 'guessing the application of the rule,' he *invents* it. Well, what would that look like? Ought he perhaps to say "Following the rule '+ 1' may mean writing 1, 1 + 1, 1 + 1 + 1, and so on"? But what does he mean by that? For the "and so on" presupposes that one has already mastered a technique. [Z 308.]

Page 76

412. How can one describe what someone does in continuing that rule?--If someone already knows how to use it, we can do it by giving the rule. And who can use it? Someone who writes 1 + 1 + 1 after 1 + 1 and after that 1 + 1 + 1 + 1.--And can I now end with "and so on"? That would surely mean: "and simply goes on according to this rule."

Page 76

413. I cannot describe how (in general) to employ rules, except by *teaching* you, *training* you to employ rules. [Z

414. I may now, e.g., make a talkie of such instruction. The teacher will sometimes say "That's right". If the pupil should ask him "Why?"--he will answer nothing, or at any rate nothing relevant, not even: "Well, because we all do it like that"; that will not be the reason. [Z 319.]

415. We don't say "It may well be like that, but it isn't". Or: "I suppose he's coming tomorrow, but actually he won't come."

416. Even in the *hypothesis* the pattern is not what you think.

I should like to say: When you say "Suppose I believe that" you are presupposing the whole grammar of the word "to believe". You are not supposing something given to you unambiguously through a picture, so to speak, so that you can tack on to this hypothetical use some assertive use other than the ordinary one. You *would not know at all* what you were supposing here, if you were not already familiar with the use of "believe". [Cf. *PI* II, x, p. 192e.]

417. What is showing its face here is the invisible application.

We are not aware of *the particular technique*, for it flows along underground, as it were, without our noticing it; and not until it openly contradicts our false imagination do we suddenly become aware of it; not until we notice, e.g., that a sentence makes no sense, that we have no idea what to do with this sentence which was not such as to arouse this suspicion straightaway. Can one tell one's doctor that one believes something as a symptom of mental illness?--But one can say, for example: "I always believe I hear voices."

"I am always supposing that he is unfaithful to me, but he isn't." The line of the concept seems to break off abruptly!--

418. "The sentence, 'I believe it and it isn't true' *can after all be the truth*. Namely, when I really believe it and this belief turns out to be wrong.

419. I say of someone else "He seems to believe..." and others say it of me. Now why do I never say it of myself, even though others are *justified* in saying it of me? Likewise: "It's obvious that he believes..." Don't I see myself?--One could say so. [*PI* II, x, p. 191f.]

420. A: "I believe it's raining."--B: "I don't believe so."--Now they are not contradicting each other; each one is simply saying something about himself.

421. "There is no such thing as a bluish yellow." This is like "There is no such thing as a regular biangle"; this could be called a proposition of colour-geometry, i.e., it is a proposition determining a concept.

422. If I had taught someone to use the names of the six primary colours, and the suffix "ish" then I could give him orders such as "Paint a greenish white here!"--But now I say to him "Paint a reddish green!" I observe his reaction. Maybe he will mix green and red and not be satisfied with the result; finally he may say "There's no such thing as a reddish green."--Analogously I could have gotten him to tell me: "There's no such thing as a regular biangle!", or "There's no such thing as the square root of -25."

423. I want to say there is a *geometrical* gap, not a physical one, between green and red. [Z 354.]

424. But doesn't anything physical correspond to it? I do not deny that. (And suppose it were merely our habituation to *these* concepts, to these language-games? But I am not saying that it is so.) If we teach a human being such-and-such a technique by means of examples,--that he then proceeds like *this* and not like *that* in a particular new case, or that in this case he gets stuck, and thus that this and not that is the 'natural' continuation for him: this of itself is an extremely important fact of nature. [Z 355.]

425. "But if by 'bluish yellow' I mean green, I am taking this expression in a different way from the original one. The original conception signifies a different road, a *no thoroughfare*."

But what is the right simile here? That of a road that is physically impassable, or of the non-existence of a road? i.e. is it one of physical or of mathematical impossibility? [Z 356.]

Page 78

426. We have a colour system as we have a number system.

Do the systems reside in *our* nature or in the nature of things? How are we to put it?--*Not* in the nature of numbers or colours. [Z 357.]

Page 78

427. Then is there something arbitrary about this system? Yes and no. It is akin both to what is arbitrary and to what is non-arbitrary. [Z 358.]

Page 78

428. It is obvious at a glance†1 that we aren't willing to acknowledge anything as a colour intermediate between red and green. (Nor does

Page Break 79

it matter whether this is always obvious to people, or whether it took experience and education to make it so.) What would we think of people who were acquainted with 'reddish-green' (e.g., who called olive-green by that name)? And what does *this* mean: "Then they have a different concept of colour altogether"? As if they wanted to say: "Well, then it wouldn't be *this* but a different concept of colour"--all the while pointing to our own. As if there were an *object* to which the concept belonged unequivocally. [First two sentences: Z 359.]

Page 79

429. These people are acquainted with reddish green. "But there is no such thing!"--What an extraordinary sentence.--(How do you know?) [Z 362.]

Page 79

430. (The picture characterizing the concept would be something like an algebraic formula.)

Page 79

431. Let's put it like this: Must these people[[sic]] notice the discrepancy? Perhaps they are too stupid. And again: perhaps not that either.--[Z 363.]

Page 79

432. Yes, but has nature nothing to say here?! Indeed she has--but she makes herself audible in another way.

"You'll surely run up against existence and non-existence somewhere!"--But that means against *facts*, not concepts. [Z 364.]

Page 79

433. It is an extremely important fact that a colour which we are inclined to call (e.g.) "reddish yellow" can really be produced (in various ways) by a mixture of red and yellow. And that we are not able to recognize straight off a colour that has come about by mixing red and green as one that can be produced in that way. (But what does "straight off" signify here?)

There could be people who recognize a regular polygon with 97 angles at first glance, and without counting. [a: Z 365.]

Page 79

434. A concept compared with a style of painting: For is even our style of painting arbitrary? Can we simply decide to adopt the style of the Egyptians? Is it a mere question of pleasing and ugly? [Cf. *PI* II, xii, p. 230c.]

Page 79

435. Did we *invent* human speech? No more than we invented walking on two legs. But if this is really so, then it is an important fact that when humans are asked to reproduce the Great Bear on their

Page Break 80

own, they will always, or for the most part, do this by drawing the lines in one particular way and never in another.

But does *that* mean that they see the constellation in this way? And does it contain the possibility of a sudden shift of aspect, for example? For it's the shift that we feel to be similar to a change in the object of sight.

Page 80

436. If there were no change of aspect then there would only be a *way of taking*, and no such thing as *seeing* this or that.

Page 80

437. This seems absurd. As if one wanted to say: "If I use only coal for heat, and never anything else, then I'm not really heating with coal."

But may it not be said: "If there were only *one* substance, there would be no use for the word 'substance'"?

That however presumably means: The concept 'substance' presupposes the concept 'difference of substance'. (As that of the king in chess presupposes that of a move in chess; or that of *colour* that of *colours*.) [b: Z 353.]

Page 80

438. I tell someone something different when I say:

- (a) that this or that form is contained in a drawing he doesn't see--
- (b) that in the drawing he does see there is a form which he hasn't yet seen--
- (c) that I've just noticed that a familiar drawing contains this form--
- (d) that I am just now seeing the drawing in this aspect.

The interest of each of these is different.

Page 80

439. The first statement is a partial description of an object that one sees, and thus resembles "I see something red over there".

The second is what I might call a "geometrical statement". In contrast to the first it is timeless. The discovery that this is so is of the same kind as mathematical discoveries.

Page 80

440. But couldn't this statement also be made in temporal form? Something like this: "If you turn this drawing this way and that you will see *this* form in it, and the lines won't seem to have moved." But it doesn't follow that we use this fact to define a concept.

Page 80

441. How does one make the *discovery*? Well, for instance one might trace--by pure accident--certain lines of the drawing on tracing

Page Break 81

paper. And then one sees: Why, that's a face! Or one is looking at the drawing, and then exclaims this sometimes while one traces those lines.--And where is the *discovery* here?--It still has to be interpreted as a discovery, and in particular as a *geometrical discovery*.

Page 81

442. I may come to see an aspect through someone's *drawing my attention* to it. But how that separates *this* 'seeing' from perceiving colours and shapes.

Page 81

443. Noticing and seeing. One doesn't say "I noticed it for five minutes."

Page 81

444. "But do we *really* see the human figures in the picture?" Only what are you asking about??

What is obviously happening here is that one rather different concept is causing trouble for another. I was supposed to be asking: "Do I really see the figures in the same sense as I really see...?" Or: "What reason do I have for talking about 'seeing' in this case? And what is it in me that makes me rebel against this?"

Page 81

445. I should like to put the question, for instance: "Am I *aware* of the spatial character, the depth of this book, for instance, the *whole* time I am seeing it?" Do I, so to speak, *feel* it the whole time?--But put the question in the third person. When would you say of someone he *was* aware of it the whole time, and when the opposite?--Suppose that you ask him--but how did he learn how to answer such a question?--Well, for instance, he knows what it means to feel pain continuously. But that will only confuse him here, just as it confuses me. [Cf. *PI* II, xi, pp. 210-211.]

Page 81

446. If he now tells me that he is continuously aware of the depth--do I believe him? And if he says he is aware of it only occasionally, when talking about it, perhaps--do I believe *that*? These answers will strike me as resting on a false foundation.--It will be different if he tells me that the object sometimes strikes him as three-dimensional, sometimes as flat. [*PI* II, xi, p. 211a.]

Page 81

447. I might get an important message to someone by sending him the picture of a landscape. Does he read it like a blueprint? That is, does he *decipher* it? He looks at it and acts accordingly. He sees rocks, trees, a house, etc. in it.

Page Break 82

Page 82

448. (The situation here is one of practical necessity, but the means of communication is one that has nothing to do with any previous agreement, definition, or the like, and that otherwise only serves quasi-poetic purposes. But on the other hand normal speech also serves poetic purposes.)

Page 82

449. The aspects of F: It is as if an *image* came into contact, and for a time remained in contact, with the visual impression. [Cf. *PI* II, xi, p. 207b.]

Page 82

450. With the black and white cross, however, it is different, and this is more closely related to the *three-dimensional* aspects (for instance, the drawing of a prism).

Page 82

451. The temptation to say "I see it like *this*", pointing to the same thing for "it" and "this". [Cf. *PI* II, xi, p. 207e.]

Page 82

452. The concept of 'seeing' makes a tangled impression. Well, it is tangled.--I look at the landscape, my gaze ranges over it, I see all sorts of distinct and indistinct movement; *this* impresses itself sharply on me, *that* is quite hazy. After all, how completely ragged what we see can appear! And now look at all that can be meant by a "description of what is seen"! But this is just what we call that. We don't have a genuine, respectable case of such description, and so we say. "Well, the rest isn't very clear as it is, being something which awaits clarification, or which must just be swept aside as rubbish." [*PI* II, xi, p. 200a.]

Page 82

453. Here we are in enormous danger of wanting to make fine distinctions. It is the same when one tries to define the concept of a material object in terms of 'what is really seen'. What we have rather to do is to *accept* the familiar language-game, and to note *false* explanations of the matter as false. The primitive language-game we originally learned needs no justification, and false attempts at justification, which force themselves on us, need to be rejected. [Cf. *PI* II, xi, p. 200b.]

Page 82

454. Conceptual facts have very complicated interrelationships.

Page 82

455. Expression should always be separated from technique. And also cases where we can indicate the technique from those where we can't.

Page Break 83

Page 83

456. I might well say: "My thoughts move naturally from *this* picture to real grass, real animals; but from that one, never."

Page 83

457. One looks at a picture and says: "Don't you *see* a squirrel!"--"Don't you *feel* the softness of this fur!"--And this is said of certain pictures, but not of others.

Page 83

458. I get the idea of the essence of a picture--an idea not unlike that of a mathematical idea--through *certain* modes of representation, in *certain* circumstances. If someone sees something I've written, then if he can read and write the Roman alphabet, he'll be able to copy it quite exactly. He has only to read it, and then write it out. Despite our different handwriting styles he'll have no difficulty producing a fairly acceptable reproduction of the lines on my sheet of paper. But if he hadn't learned to read and write the Roman alphabet then it would have been much more difficult for him to copy the maze of lines. Now, should I say: Whoever has learned these things would *see* my handwriting completely differently from someone who had not?--What do we know about this? It could be that we gave someone that sheet of paper to copy before he had learned to read and write; and then again, after he had learned to read and write. And then he might tell us: "Oh yes, now I see these lines completely differently." Possibly he might also explain: "Now all I really see is the writing that I'm reading; all else is floss, which doesn't concern me, and which I hardly notice." Well this means that he sees the picture differently--when, that is, he actually does react to it differently.

Likewise, compared to someone who can't read, someone who can will be able to give a different account of a sheet of paper criss-crossed with writing. And this analogy holds too for speaking and its accompanying sounds.

Page 83

459. To this there is the answer, "I have never looked at a  with that in mind."

Page 83

460. Suppose someone were to answer: "For me it is *always* facing in that direction."--Would we accept his answer? It would seem to assert that he always thinks of such connections whenever he looks at that letter (just as we say: "Whenever I see this man, I have to think of how he...").

Page Break 84

461. But if we now see the picture of a face, or even a real face--can we also say: I only see it looking in this direction so long as I am occupied with it *in this way*?--What is the difference? The report: "This face is looking to the right"--usually refers to the position of the face. I make it to someone who doesn't see the face himself. It is the report of a perception.

462. But does this then show that it can't be a matter of 'seeing' in these cases--but it is one of 'thinking', perhaps? What makes this quite unlikely is that we want to talk about 'seeing' in the first place.--So should I say that it is a phenomenon between seeing and thinking? No; but a concept that lies between that of seeing and thinking, that is, which bears a resemblance to both; and the phenomena which are akin to those of seeing and thinking (e.g. the phenomena of the utterance "I see the F facing to the right").

463. How does one tell that human beings *see* three-dimensionally? I ask someone about the lie of the land of which he has a view. "Is it like *this*?" (a spacial gesture)--"Yes."--"How do you know?"--"It's not misty, I see quite clearly."--He does not give reasons for the *surmise*. The only thing that is natural to us is to represent what we see three-dimensionally; special practice and training are needed for two-dimensional representation whether in drawing or words. The queerness of children's drawings. [PI II, xi, p. 198d.]

464. What is lacking to anyone who doesn't understand the question which way the letter F is facing, where, for example, to paint a nose on?

Or to anyone who doesn't find that a word loses something when it is repeated several times, namely, its meaning; or to someone who doesn't find that it then becomes a mere sound?

We say: "At first something like an image was there."

465. Is it that such a person is unable to appreciate a sentence, judge it, the way those who understand it can? Is it that for him the sentence is not alive (with all that that implies)? Is it that the word does not have an aroma of meaning? And that therefore he will often react differently to a word than we do?--It *might* be that way.

466. But if I hear a tune with understanding, doesn't something special go on in me--which does not go on if I hear it without understanding? And *what*?--No answer comes; or anything that

occurs to me is insipid. I may indeed say: "Now I've understood it," and perhaps talk about it, play it, compare it with others etc. *Signs* of understanding may accompany hearing. [Z 162.]

467. It is wrong to call understanding a process that accompanies hearing. (Of course its manifestation, expressive playing, cannot be called an accompaniment of hearing either.) [Z 163.]

468. For how can it be explained what 'expressive playing' is? Certainly not by anything that accompanies the playing.--What is needed for the explanation? One might say: a culture.--If someone is brought up in a particular culture--and then reacts to music in such-and-such a way, you can teach him the use of the phrase "expressive playing". [Z 164.]

469. The understanding of a theme is neither sensation nor a sum of sensations. Nevertheless it is correct to call it an experience inasmuch as *this* concept of understanding has some kinship with other concepts of experience. You say "I experienced that passage quite differently this time". But still this expression 'describes what happened' only for someone familiar with a particular system of concepts. (Analogy: "I won the match.")†1 [Z 165.]

470. *This* floats before my mind as I read. So does something go on in reading...? This question doesn't get us anywhere. [Z 166.]

471. But how can it float before me? Not in the dimensions you are thinking of. [Z 167.]

472. We find certain things about seeing puzzling, because we do not find the whole business of seeing puzzling enough. [PI II, xi, p. 212f.]

473. We all know that a cube which is clearly depicted will be seen three-dimensionally. One might not even be able

to describe what one sees in anything other than three-dimensional terms. And it is clear that someone *could* also see this picture as flat. Now, if he alternately sees the picture in one way, then in the other, he is

Page Break 86

experiencing a change of aspect. What is so amazing about *that*?--Is it this: that the report "Now I see..." can no longer be a report about the object that is perceived. For earlier "I see a cube in this picture" was a report about the object I am looking at.

Page 86

474. What is incomprehensible is that *nothing*, and yet *everything*, has changed, after all. That is the only way to put it. Surely *this* way is wrong: It has not changed in *one* respect, but has in another. There would be nothing strange about that. But "Nothing has changed" means: Although I have no right to change my report about what I saw, since I see the same things now as before--still, I am incomprehensibly compelled to report completely different things, one after the other.

Page 86

475. And it is *not* like this: I simply see the picture as one of an infinitely large number of bodies, whose projection it is;--rather, I see it *only* as *this*--or as that. So the picture is alternately one and the other.

Page 86

476. We now have a language-game that is remarkably the *same* as, and remarkably *different* from, the previous one. Now what follows from the expression "Now I see..." is completely different, even though there is once again a close relationship between the language-games.

Page 86

477. We wouldn't have been surprised that the eye (the dot on our picture) is looking in one direction--unless it *changed* the direction in which it looked.

Page 86

478. This question naturally suggests itself: Can we imagine people who never see anything as *anything*? Would they be lacking an important sense, such as if they were colour-blind or they lacked perfect pitch? For the time being let us call such people "gestalt-blind" or "aspect-blind".

Page 86

479. Here the question will arise: To what *kind* of aspect is someone blind. Should I assume, for example, that he cannot see the schematic cube three-dimensionally, first *one* way, then another? If this is to be the case, then in consistency I should have to suppose that he couldn't see the picture of a cube as a cube, and therefore couldn't see the picture of a three-dimensional object as a three-dimensional object. So he would generally have a different attitude toward pictures than we do. It might be the kind of attitude which we have toward a

Page Break 87

blueprint. For example, he would be able to work according to a pictorial representation.--But then we face the difficulty that it would never be possible for him to take a picture for a three-dimensional object, as we do sometimes with *trompe l'oeil* architecture. And *that* could not very well be called a sort of blindness; on the contrary. (This investigation is not psychological.)

Page 87

480. Of course it is imaginable that someone might never see a change of aspect, the three-dimensional aspect of every picture always remaining constant for him, for example. But this assumption *doesn't interest us*.

Page 87

481. It is conceivable, however, and also important for us, that some people might have a completely different relation to pictures than we do.

Page 87

482. Thus we could imagine someone who would see only a painted face as a face, but not one that consists of a circle and four dots; who wouldn't see the duck-rabbit picture as a picture of the head of an animal, and therefore wouldn't see the change of aspect with which we are familiar.

Page 87

483. Let's assume that someone cannot see the picture of a runner as a picture of motion: How would this come out? I'm assuming that he has *learned* that such a picture as this portrays a runner. Thus that he can say that it is a runner; how will this man differ from normal human beings? I shall assume that he will show absolutely no understanding that motion is being represented in a picture. And what would we call the signs of this defective understanding?--We can easily fill out the picture. (But if such a man were able to see any picture and then copy it exactly, we certainly wouldn't say of him that his visual sense was deficient.)

Clearly the words "Now I am seeing *this* as the apex--now *that*" won't mean anything to a learner who has only just met the concepts apex, base, and so on. But I did not mean this as an empirical proposition. [b: cf. *PI* II, xi, p. 208e.]

Page 87

484. "Now he's seeing it like *this*", "now like *that*" would only be said of someone *capable* of making all sorts of applications of the figure quite freely. [*PI* II, xi, p. 208e.]

Page 87

485. But how queer for this to be the condition of his having such-and-such an *experience*! After all, you don't say that one only has

Page Break 88

toothache if one is capable of doing such-and-such. From this it follows that we're not dealing with the same concept of experience here.

The concept of experience is different each time, even though related. [*PI* II, xi, p. 208f.]

Page 88

486. We speak, make utterances, but only later do we form a picture of their life. [*PI* II, xi, p. 209a.]

Page 88

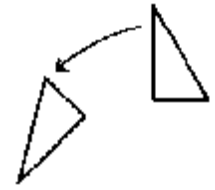

487. We could, however, imagine the following way of teaching the pupil to see it that way: In addition to the first triangle we draw a second one, which is the one that hasn't toppled over yet.† Later we omit the second triangle, and now the student can see the first one as toppled over.--But does he have to understand the illustration, or at least see it correctly?--It might merely add to his confusion.

If that illustration says nothing to someone, then other pictures won't speak to him either, as they do to us; he will not react to them as we do. (Not empirically.) Analogy with the picture of the galloping horse.

Page 88

488. It is anything but a matter of course that we see 'three-dimensionally' with two eyes. If the two visual images are amalgamated, we might expect a blurred one as a result, like a wobbled photograph. [*PI* II, xi, p. 213b.]

Page 88

489. A code which I and another man have agreed on, in which "bench" means apple. Immediately after we agree I say to him: "Take these benches away!"--He understands me, and does it; but he still feels the word "bench" to be strange in this use, and when he hears it he might have the image of a bench. [Cf. *PI* II, xi, p. 214f.]

Page 88

490. What would we say of someone who couldn't see the schematic cube now as an upright box, now as one lying on its side? If this is a defect, isn't it one of the imagination rather than of visual sense?

Page Break 89

Page 89

491. But what a strange method!--I form a concept and ask myself how one might follow through with it consistently. What we feel would deserve to be called that. To be sure, we do see a painting three-dimensionally, and we would have a hard time describing it as a composite of flat colour surfaces, but what we see in a stereoscope looks three-dimensional in an entirely different way again. Someone who looks at a photograph, whether it is one of human beings, houses, or trees, doesn't seem to miss three-dimensionality in it! ((To the remark about seeing three-dimensionally with both eyes.)) [Cf. *PI* II, xi, p. 213a.]

Page 89

492. I can see the schematic cube as a box, but *not*: now as a paper box, now as a tin box.--What ought I to say if someone assured me he could see the figure as a *tin* box? Should I answer that that isn't *seeing*? But if he couldn't see, could he then *sense* it?

Of course it would be plausible if we said to him: Only what can really be seen can be *visually* imagined in that way. ((Knowing in dreams.)) [Cf. *PI* II, xi, p. 208b.]

Page 89

493. When you come out of a movie onto the street, you sometimes have the experience of seeing the street and the people as if they were on the screen and part of the plot of a movie. How come? *How* does one see the street and the people? I can only say: I have the fleeting thought, for example, "Perhaps *this* man will be a main character in the

plot". But that's not all there is to it. Somehow my attitude toward the street and the people is like the one toward the action on the screen. Perhaps something like mild curiosity, or enjoyment.--But initially I can't even say all that.

Page 89

494. Doesn't it take imagination to hear something as a variation on a particular theme? And yet one is perceiving something in so hearing it. [*PI* II, xi, p. 213c.]

Page 89

495. "Imagine *this* changed like this, and you have this other thing." In general, one would like to say that the power of imagination can substitute for a picture, or a demonstration. [Cf. *PI* II, xi, p. 213d.]

Page 89

496. One can express the aspects of the double-cross simply by pointing first to a white cross, then to a black one, which is to say, to the same things someone would point to if he were asking "Is *this* contained in the figure on this paper?"--The same question could be asked about the duck-rabbit picture. But it is also clear that each case here differs slightly from the other.

Page Break 90

Page 90

For in order to express the aspects of this picture, one points to something that is not contained in the picture, such as the black cross in the double cross.

Page 90

497. But you do speak of *understanding* music. You understand it, surely, *while* you hear it! Ought we to say this is an experience which accompanies the hearing? [Z 159.]

Page 90

498. I give signs of delight and comprehension.

Page 90

Is it hair-splitting to say: joy, enjoyment, delight, are not sensations?--Let us at least ask ourselves: How much analogy is there between delight and what we call, e.g. "sensation"? [a: Z 515; b: Z 484.]

Page 90

499. The connecting link between them would be pain. For this concept resembles that of, e.g., tactile sensation (through the characteristics of localization, genuine duration, intensity, quality) and at the same time that of the emotions through its expression (facial expressions, gestures, noises). [Z 485.]

Page 90

500. How do I know that someone is enchanted? How does one learn the linguistic expression of enchantment? What does it connect up with? With the expression of bodily sensations? Do we ask someone what he feels in his breast and facial muscles in order to find out whether he is feeling enjoyment? [Z 168.]

Page 90

501. But does that mean that there aren't any sensations after all which often return when one is enjoying music? Certainly not. (In some places he is near weeping, and he feels it in his throat.)

A poem makes an impression on us as we read it. "Do you feel the same while you read it as when you read something indifferent?"--How have I learnt to answer this question? Perhaps I shall say "Of course not!"--which is as much as to say: *this* takes hold of me, and the other not. "I experience something different."--And what kind of thing?--I can give no satisfactory answer. For the answer I give is nothing of importance.--"But didn't you enjoy it *during* the reading?" Of course--for the opposite answer would mean: I enjoyed it earlier or later, and I don't want to say that.

But now you remember certain sensations and images and thoughts as you read, and they are such as were not irrelevant for the enjoyment, for the impression.--But I should like to say that they get their correctness only from their surroundings: through the

Page Break 91

reading of this poem, from my *knowledge* of the language, with its meter and with innumerable other things. (These eyes smile only in *this* face and in *this* temporal context.)

You must ask how we learnt the expression "Isn't that glorious!" (e.g.) at all.--No one explained it to us by referring to sensations, images or thoughts that accompany hearing! Nor should we doubt whether he had enjoyed it if he had no account to give of such experiences; though we should, if he showed that he did not understand certain tie-ups. [a: cf. Z 169; b, c, d: cf. Z 170.]

Page 91

502. But isn't understanding shown, e.g., in the expression with which someone reads the poem, sings the tune? Certainly. But what is the experience during the reading? About that you would just have to say: you enjoy and

understand it if you hear it well read, or feel it well read in your speech-organs. [Z 171.]

Page 91

503. Understanding a musical phrase may also be called understanding a *language*. [Z 172.]

Page 91

504. I think of a quite short phrase, consisting of only two bars. You say "What a lot that's got in it!" But it is only, so to speak, an optical illusion if you think that what is there goes on as we hear it. (Consider that sometimes we say, and say rightfully: "It all depends *who* says it".) (Only in the stream of thought and life do words have meaning.) [Z 173.]

Page 91

505. What contains the illusion is not *this*: "Now I've understood"--followed perhaps by a long explanation of what I have understood. [Z 174.]

Page 91

506. How does seeing an aspect hang together with the ability to perform certain operations (e.g. in mathematics)? Think of seeing three-dimensionally in descriptive geometry and operating within the drawing. He moves his pencil on the surface of the drawing as if he were moving within the real object. But how can that be proof of *seeing*?

Well, don't we accept it as proof of seeing if somebody moves about a room with confidence? There are simply different criteria for seeing. Ask yourself: does someone who has no trouble picturing animals, people, and all sorts of things in his imagination, or in his memory, have to see them with his inner eye? The answer could be: "In such a case we simply *say*..."--But it could also be: "You have to ask the person doing the drawing whether he's doing this or not."

Page Break 92

Page 92

507. Now there is a tie-up between aspect and imagination.

Page 92

508. The aspects of surface and base. What would a person who is blind towards these aspects be lacking?--It is not absurd to answer: the power of imagination.

Page 92

509. Bear in mind that there is frequently a 'right' word for an aspect.

Suppose we have someone look at the double cross and tell us which of the *two* aspects (black cross or white cross) he sees. It will probably be irrelevant whether he says that sometimes he sees something like a little white windmill with four sails and sometimes an upright black cross, or whether he sees the white cross as the four corners of a piece of paper folded toward the middle. The cross which is "now" seen can also be seen as an *opening* in the shape of a cross. But *these* differences needn't matter to us; and therefore one could distinguish between "purely optical" aspects and "conceptual" ones. ((Similarly, the particular words someone uses to describe the events in a dream may or may not matter.))

Page 92

510. "See F as  "†1 could not be understood before something quite different has been said. For would I understand "See this triangle as that triangle"?†2 There must first be a conceptual connection.

Page 92

511. "It seems to me now to be facing left--and now right again." That is, the way it was before? No; earlier it had no *direction* for me. Earlier I didn't surround it with this world of images.

Page 92

512. Attention is dynamic, not static--one would like to say. I begin by comparing attention to gazing but that is not what I call attention; and now I want to say that I find it is *impossible* that one should attend statically. [Z 673.]

Page 92

513. Someone might see a boulder and exclaim: "A man!", and then he might point out to someone else how he sees the man in the boulder--where the face is, the feet are, etc. (Someone else might see a man in the same shape, but in a different way.)

Page Break 93

Page 93

It will be said that it takes imagination to see that, but that no imagination is required to recognize a true-to-life picture of a dog as a dog.

Page 93

514. "He's comparing the boulder to a human shape," "He sees a human shape in it"--but it's not in the same sense

that we say: He's comparing that picture with a dog, or this passport photograph with a face.

Page 93

515. When I'm looking at the photograph, I don't tell myself "That could be seen as a human being". Nor when looking at an F do I say: "That could be seen as an F."

Page 93

516. If somebody showed me the figure and asked me "What is that?", I could answer him only *that way*.--I couldn't answer: "I take that to be a..." or "Probably that is a..." Any more than I *take* letters to be this or that when I'm reading a book.

Page 93

517. "I see it as a ..." is connected with "I'm trying to see it as ...", or "I can't see it as ... yet". But you cannot try to see the regular F as a regular F.

Page 93

518. To ask someone's advice mentally. To estimate the time by *imagining* a clock.

Page 93

519. The aspect presents a physiognomy which then passes away. It is almost as if there were a face there which at first I *imitate*, and then accept without imitating it.--And isn't this really explanation enough?--But isn't it too much? [PI II, xi, p. 210e.]

Page 93

520. If in a particular case I say: attention consists in preparedness to follow each smallest movement that may appear--that is enough to show you that attention is not a fixed gaze: no, this is a concept of a different kind. [Z 674.]

Page 93

521. We see, not change of aspect, but change of interpretation. [Z 216.]

Page 93

522. You see it conformably, not to an interpretation, but to an act of interpreting. [Z 217.]

Page 93

523. If someone were asked, "Can you see F as an ef?" he wouldn't understand us. But he would understand if we asked, "Can you see it

Page Break 94

as a backwards F?" And he would also understand: "And can you now see it as a regular ef again?"--Why?

"Can you see it as ...?" or "Now look at it as a ...!" go together with "Now take it as a ...".

Only where this command makes sense does the question make sense.

Page 94

524. Imagine that someone were to point to a regular printed F and say, "Now it is an ef".--What does that mean? Does it make any sense? For the time being it has none. To what extent is it NOW an ef? Insofar as it always is? And in contrast to what?--I look at a lamp and say "Now it is a lamp."--What can I mean?

Page 94

525. You need new conceptual glasses.

Page 94

526. If you say "Now it's a face for me", we can ask: "What sort of change are you alluding to?" [PI II, xi, p. 195d.]

Page 94

527. The cry "A hare!" is, after all, related to the *report* "a hare".

Page 94

528. What is an expression of amazement? Can it be a stationary attitude? Can amazement thus be a state of inactivity?

Page 94

529. Suppose someone were to ask: "Why can't you hold on to the experience of surprise?"

Page 94

530. "The ef vanishes and a cross appears in its place; the cross vanishes and a backwards F appears in its place; etc." That is, after all, the way we express changes in perception.

Page 94

531. *Forget*, forget that you have these experiences yourself! [Z 179.]

Page 94

532. Our eye seems each time to be drawing a different shape in these lines (on the paper).

Page 94

533. Different pictures appear to me. But *how* different are they? In what do they differ? That I can explain only by referring to their origin.

534. I say something; and it is correct;--but then I misunderstand the use to which the statement would be put.

535. How does one play the game "It could be *this* too"? What a figure could also be--which is what it can be seen as--is not simply another figure. Thus it made no sense to say: F could also be an ∇ . †1 Nor would this make sense:--this could mean several entirely different things.

But one could play that game, for instance, with a child. Together we look at a shape; or at a random object (a piece of furniture)--and then it is said: "That is now supposed to be a house."--And now it is reported, talked about, and treated as if it were a house, and it is altogether interpreted as this. Then, when the same thing is made to stand for something else, a different fabric will be woven around it. [a: cf. *PI* II, xi, p. 206d; b: cf. *PI*, p. 206e.]

536. How will you know whether the child *sees* the thing as that? Well, he might spontaneously say so. He might say something like: "Yes, *now* I see it as ... ". And in *this* situation, with the lively participation in the fiction, it will indeed signify the seeing of the aspect.

537. I want to say: this game is *related* to seeing the aspects of F, for example.

A person's ability, as it were, to play-act things is a prerequisite for his meaning the same thing we do when he says "Now I see it as...".

538. How do you teach a child, say in arithmetic: "Now take *these* things together!", or "Now *these* go together"? Clearly "taking together" and "going together" must originally have had another meaning for him than that of *seeing* in this way or that.--And this was a remark about concepts, not about teaching methods. [*PI* II, xi, p. 208c.]

539. To be sure, one can say "See this shape as a... for five minutes", if this means: He is to hold it, to keep it balanced, in this aspect.

540. What do you understand if someone says "I see it (i.e. the regular F) as an *ef*"?--That he is dealing with aspects; that it is an unstable situation. That he is thinking "It could also be that."

541. Seeing aspects is built up on the basis of other games.

542. We certainly speak of calculating in our imagination. So it is not surprising that the power of imagination can contribute to knowledge.

543. But I don't want to say that an aspect is a mental image. Rather that 'seeing an aspect' and 'imaging something' are related concepts. [Cf. *PI* II, xi, p. 213c.]

544. One wants to ask of seeing an aspect: "Is it seeing? Is it *thinking*?" The aspect is subject to the will: this by itself relates it to thinking.

545. "The aspect is subject to the will." This isn't an empirical proposition. It makes sense to say, "See this circle as a hole, not as a disc", but it doesn't make sense to say "See it as a rectangle", "See it as being red".

546. Do I really see something different each time, or do I only interpret what I see in a different way? I am inclined to say the former. But why?--To interpret is to think, to do something. [*PI* II, xi, p. 212d.]

547. The cases in which we *interpret* what we see are easily recognized. When we interpret we put forth a hypothesis which may turn out to be wrong. "I see this shape as a..." can no more be verified than (or can be verified only in the same sense as) the statement "I see a bright red". So here we have a similar use of the word "see" in both contexts.

548. Suppose someone were to ask: "Do we all see an F in the same way?" What could he mean by that?--We could

make this test: we show an F to different people and ask them whether the F faces to the right or to the left. Or we could ask: "If you compare an F with the profile of a face, in which direction is the face looking?"

But many people might not understand this question. As many do not understand the question, "What colour is the vowel *a* for you?"--If someone didn't understand the question, if he claimed that it was nonsensical, could we say that he doesn't understand English, or at least the meanings of the words "colour", "vowel", etc.?

On the contrary: When he has learned to understand these words, then he can react to these questions, either "with" or "without understanding". [b, c: Z 185.]

Page Break 97

Page 97

549. Suppose, instead of "in which direction is the letter... facing?", the question had been: "If you were to paint an eye and a nose onto an F or a J, in which direction would they be facing?" Surely this too would be a psychological question. But it doesn't have to do with '*seeing* something this way or that'. Rather, it deals with an *inclination* to do one or the other. (But we must think about how someone would arrive at his answer to this question.)--Thus this kind of seeing is related to an inclination. The inclination can change, or be absent altogether.

Page 97

550. "With this arrangement of windows the facade faces *that* way."

"The windows used to be arranged so that the facade faced *that* way.

The first sentence is like a proposition of geometry. In the second one, the concept of the 'direction in which the facade faces' serves to describe the facade. Just as we describe a face using the concepts 'happy', 'sullen', 'suspicious', or a movement by the words "fearful", "hesitant", "sure". And to the extent that these are descriptions of what has been visually perceived, or observed, they are also descriptions of the visual impression. So one can say that he *sees* the hesitation. (A person copying a picture can be told, "The face isn't right yet; it isn't sad enough.")

Page 97

551. Anyone with an eye for family resemblances can recognize that two people are related to each other, even without being able to say wherein the resemblance lies. (Think of the case of the calculating-genius.)

Page 97

552. It might be an incorrect use of language to say "I see fear in this face". We would be taught: a fearful face can be '*seen*'; but the fear in a face, or the similarity or dissimilarity between two faces, is '*noticed*'.

Page 97

553. The kinship of these two concepts is shown in this explanation: If you want to see how they differ, think of the sense it could make to say that someone saw the similarity between two faces from one stroke of the hour to the next. Or think of the order: "Notice the similarity from... to...!"

Page 97

554. A drawing can be the description of a visual impression. What is at the top of the drawing, what is at the bottom, is usually of the greatest importance. But someone could also stipulate a distance at

Page Break 98

which we should hold the drawing from our eyes. Indeed, even a spot on the drawing at which we are to look could be stipulated, or how our eyes are to travel over the drawing.

Page 98

555. I begin seeing the similarity when it "strikes" me; and do I then see it as long as I see the similar objects? Or only as long as I am *conscious* of the similarity?--If the similarity strikes me, I perceive something, but I don't have to remain conscious of it in order to perceive that it doesn't change.

Page 98

556. Two uses of the statement "I see...". One language-game: "What do you see there?"--"I see...", and then a description of what was seen follows, either in words, or through a drawing, or a model, or gestures, etc.--Another language-game: We look at two faces and I say to someone: "I see a similarity in them."

In the first language-game the description could have gone something like this: "I see two faces which are as like as father and son." This can be called a far less complete description than the one that uses a drawing. But someone could give this more complete description and still not notice that similarity. Another might see the drawing of the first one and discover the family resemblance in it; and in the same way he might see a similarity between their facial expressions. [a: cf. *PI* II, xi, p. 193a.]

Page 98

557. "When I uttered the word just now, it meant ... to me." Why should that not be mere lunacy? Because *I* experienced that? That is not a reason. [Z 182.]

Page 98

558. Those cases in which the inner seems hidden from me are very *peculiar*. And the uncertainty which is expressed in this is not a philosophical one; no, it is practical and primitive.

Page 98

559. It is then as if I realized for the first time that the inner is really always hidden.

Page 98

560. (We also say that the man is completely transparent.) So sometimes someone is transparent, sometimes not.

Page 98

561. "I can never know what goes on inside him."--But does something have to go on inside him? And why should I be concerned

Page Break 99

with that?--But this picture suggests a real uncertainty, not one we've dreamed up.

Page 99

562. What is the importance of someone making this or that confession? Does he have to be able to judge his condition correctly?--What matters here is not an inner condition which he judges, but just his confession.

(His confession can explain certain things. For example, it can cause me to stop suspecting someone else.)

Page 99

563. The principal uncertainty: I don't know what he is thinking if he doesn't express it. Now suppose he does express it, but in a language you don't understand. He could tap it out with the finger of one hand on the back of his other hand in morse code, or some such thing. Then too, after all, it is secret, and isn't it *just as* secret as if it had never been expressed? The language could also be such that I could never learn it, e.g. its rules might be extraordinarily complicated.

Page 99

564. So someone can hide his thoughts from me by expressing them in a language I don't know. But where is the mental thing which is hidden?

Page 99

565. I may choose the language in which I think. But not as if I think, and then choose the language into which I want to translate my non-verbal thoughts.

Page 99

566. You can be as *certain* of someone else's sensations as of *any* fact. But this does not make the propositions "He is happy" and " $2 \times 2 = 4$ " into similar instruments. It suggests itself to say, "The certainty is of a different kind", but that doesn't remove the obscurity. [Cf. *PI*, II, xi, p. 224c.]

Page 99

567. "But, if you are *certain*, isn't it that you are shutting your eyes in face of doubt?"--They are shut.

It is indeed true: this kind of doubt is arrived at in a completely different way from doubt about an arithmetical proposition. Above all, in the former case complete certainty is the limit of a *belief* which differs by degrees.--*Everything* is simply different. [a: *PI* II, xi, p. 224d.]

Page 99

568. And then there is what I should like to call the case of hopeless doubt. When I say, "I have no idea what he is really thinking--". He's a closed book to me. When the only way to understand someone else would be to go through the same upbringing as his--which is

Page Break 100

impossible. Here there's no pretence. But imagine people whose upbringing is directed toward suppressing the expression of emotion in their faces and gestures; and suppose these people make themselves inaccessible to me by thinking aloud in a language I don't understand. Now I say "I have no idea what is going on inside them", and there it is--an external fact.

Page 100

569. "I cannot know what is going on in him" is above all a *picture*. It is the convincing expression of a conviction. It does not give the reasons for the conviction. They are not something that can be *seen* directly. [*PI* II, xi, p. 223g.]

Page 100

570. "We *see* emotion."--As opposed to what?--We do not see facial contortions and *make the inference* that he is feeling joy, grief, boredom. We describe a face immediately as sad, radiant, bored, even when we are unable to give any other description of the features.--Grief, one would like to say, is personified in the face. This is essential to what we call "emotion". [Cf. *Z* 225.]

Page 100

571. The man I call meaning-blind will understand the instruction "Tell him he is to go to the bank--and I mean the

river bank," but not "Say the word bank and mean the bank of a river".

He will also not be able to report that he almost succeeded, but that then the word slipped into the wrong meaning. It does not occur to him that the word has something in it which positively fixes the meaning, as a spelling may; nor does its spelling seem to him to be a picture of the meaning, as it were.--For instance, it is very tempting to think that a different spelling will lead to at least a very small difference in pronunciation, even where this is certainly not so. Here we have a case which can serve as an example for many others: You say the two words (e.g. "for" and "four") to yourself and you really do pronounce them a little differently, even though you don't do this in the normal course of speech, when you're not thinking about it. And this is so if for no other reason than that each word is pronounced differently on different occasions. [a: cf. Z 183a.]

Page 100

572. Different people are very different in their sensitiveness about changes in the orthography of a word. And the feeling is not just piety towards an old use.--If for you spelling is just a practical question, the feeling you are lacking in is not unlike the one that a 'meaning-blind' man would lack. [Z 184.]

Page Break 101

Page 101

573. How could he hear the word with that meaning? How was it possible?!--It just wasn't--not in *these* dimensions. [Z 180.]

Page 101

574. But isn't it true, then, that the word means that to me now? Why not? For this sense doesn't come into conflict with the rest of the use of the word.

Someone says: "Give him the order... and *mean* by it...!" What can that mean?

But why do you use just this expression for your experience?--such a poor fit!--That is the expression of the experience, just as "The vowel *e* is yellow" and "In my dream I knew that..." are expressions of other experiences. It is a poor fit only if you take it the wrong way.

This expression goes with the experience just as the primitive expression of pain goes with pain. [a, b: Z 181.]

Page 101

575. William James: The thought is already complete at the beginning of the sentence. How can one know that?--But the *intention* of uttering the thought may already exist before the first word has been said. For if you ask someone: "Do you know what you mean to say?" he will often say yes.

It is my intention to whistle this theme: have I then already, in some sense, whistled it in thought? [a: Z 1; b: Z 2b.]

Page 101

576. Whoever answers "Yes" to the question, "Do you know yet what you want to say?" may have some mental image or other; but if this could be heard or seen objectively, then there would generally not be any way of deriving what he intended from it with certainty. (Raising your hand in class.)

Page 101

577. Not everyone with an intention has therefore made a *plan*.

Page 101

578. What forms of mental defects actually exist is of no concern to *us*; but the possibilities of such forms do concern us. It is not whether there are men incapable of thinking "At that time I wanted to...", but how this concept can be followed through. [Cf. Z 183a.]

Page 101

579. How could this assumption be followed through consistently? What would we call a consistent follow-through?--If you assume that someone cannot do *this*, then how about *that*? Is he also unable to do this?--Where does this concept take us? [From "If you assume" cf. Z 183b.]

Page Break 102

Page 102

580. "You must earnestly promise yourself to do it, and then you'll do it." Earnestly promising something requires thinking about it, for instance. It requires a particular preparation. Finally there might actually be a formal promise, perhaps even in a loud voice, but that is just *one* stone in this building. (Vows.)

Page 102

581. A vow could be called a ceremony. (Baptism, even when it is not a Christian sacrament.) And a ceremony has an importance all its own.

Page 102

582. "I had the intention of..." does not express the memory of an experience. (Any more than "I was on the point

of...") [Z 44.]

Page 102

583. "What a queer and frightful sound. I shall never forget it." And why should one not be able to say that of remembering ("What a queer... experience...") when one has seen into the past for the first time?--[Z 661.]

Page 102

584. Couldn't he just be imagining that he calculated this? (That he now knows the solution to the problem is not supposed to be inconsistent with this. And he might indeed have miscalculated.) And if there *is* no mistake here, then this is not because there is certainty.

Page 102

585. Someone tells me he has just worked out in his head how much... \times ... is. He gives an obviously wrong answer, and when asked how he arrived at it, he recites the calculation; it is utter nonsense, as he himself now realizes, but at that time, he says, it seemed completely correct. (Something similar occurs in dreams.) Can't that happen? His mental arithmetic, I want to say, still must prove itself.

Page 102

586. "In hiding something from me, he can hide it in such a way that not only will I never find it, but finding it will be completely inconceivable." This would be a metaphysical hiding.--But what if, without knowing it, he were to give signs that give him away? That would be possible, after all.--Now wouldn't *he* be the only judge of whether those signs have given him away?--But couldn't I insist that he forgot what happened inside him--and thus not let his statement count? (Without calling it a lie.) That means that I declare it worthless, or give it value only as a phenomenon, from which inferences about his state might be drawn.

Page Break 103

Page 103

587. If something is hidden--isn't it as if writing were hidden, or rather something which looks like writing, whose meaning only lies in what he reads out of it, or into it, at some point?

Page 103

588. Of course he can *mislead* me, make me arrive at false conclusions. But it doesn't follow from this that he has hidden anything; even though the way he behaves can be compared to hiding.

Page 103

589. Haven't I the *right* to be convinced that he is not pretending to me?--And can't I convince someone else of my right?

Page 103

590. If I tell him in full detail how my friend behaved, will he have any reasonable doubt as to the genuineness of my friend's feelings?

Page 103

Does anyone doubt the genuineness of Lear's feelings?

Page 103

591. Is it thoughtlessness not to keep the *possibility* of pretence in mind?

Page 103

592. Remembering: a seeing into the past. *Dreaming* might be called that, when it presents the past to us. But not remembering; for, even if it showed scenes with hallucinatory clarity, still it takes remembering to tell us that this is past. [Z 662.]

Page 103

593. But if memory shows us the past, how does it show us that it is the past?

It does *not* show us the past. Any more than our senses show us the present. [Z 663.]

Page 103

594. Nor can it be said to communicate the past to us. For even supposing that memory were an audible voice that spoke to us--how could we understand it? If it tells us, e.g. "Yesterday the weather was fine", how can I learn what "yesterday" means? [Z 664.]

Page 103

595. I give myself an exhibition of something only *in the same way* as I give one to other people. [Z 665.]

Page 103

596. I can display my good memory to someone else and also to myself. I can subject myself to an examination. (Vocabulary, dates.) [Z 666.]

Page Break 104

Page 104

597. But how do I give myself an exhibition of remembering? Well, I ask myself "How did I spend this morning?" and give myself an answer.--But what have I really exhibited to myself? Remembering? That is, what it's like to remember something?--Should I have exhibited remembering to *someone else* by doing that? [Z 667.]

Page 104

598. "To purpose to do something is a special inner process."--But what sort of process--even if you could dream one up--could satisfy our requirements about purpose? [Z 192.]

Page 104

599. Imagine men who show pity only when they see someone else bleeding; otherwise they laugh at his expressions of pain. That's the way it is with them. Some smear themselves with animal blood to be pitied. If they're found out they're severely punished.

Page 104

600. They don't ask the question: "Couldn't he be feeling pain anyway?"

Page 104

601. These people need not have certain scruples.

Page 104

602. Do I pay any mind to his inner processes if I *trust* him? If I don't trust him I say, "I don't know what's going on inside him". But if I trust him, I don't say that I know what's going on inside him.

Page 104

603. If I don't distrust him, I don't pay any mind to what is going on inside him. (Words and their meaning. The meaning of words, what stands behind them, doesn't concern me in normal conversation. Words flow along and transitions are made from words to actions and from actions to words. When someone's performing mathematical calculations he doesn't stop to think whether he is doing it 'thoughtfully' or 'parrot-like'. (Frege.))

Page 104

604. There might be people who speak to themselves quite a bit before and while they are doing something, and then again there might be people who only say very little to themselves. When he is asked: "What were you thinking when you did that?" he confesses, perhaps quite honestly, "Nothing at all", even though what he did seems to us to have been well thought out, possibly even shrewd. I say that I don't know what is going on inside him, and in an important sense nothing is going on inside him. I don't know my way about with him: for example, I make erroneous suppositions quite easily, and from time to time I am very disappointed in my expectations.

Page Break 105

Page 105

I could visualize this person by imagining that he accompanies all of his actions with monologues, which express his sentiments. The monologues would be a construction, a working hypothesis, by which I try to comprehend his actions. Must I now assume thinking to be going on inside him *apart* from those monologues? Are the monologues not quite enough? Can't they do everything the inner life is supposed to do?

Page 105

605. It is easy to imagine and work out in full detail events which, if they actually came about, would throw us out in all our judgments.

If I were to see quite new surroundings from my window instead of the long familiar ones, if things were to behave as they never did before, then I should say something like "I have gone mad"; but that would merely be an expression of giving up the attempt to know my way about. And the same thing might befall me in mathematics. It might, *e.g.*, *seem* as if I kept on making mistakes in calculating, so that no answer seemed reliable to me.

But the important thing about this for me is that there isn't any sharp line between such a condition and the normal one. [Z 393.]

Page 105

606. Why is it important to depict anomalies accurately? If someone can't do this, that shows that he isn't quite at home yet among the concepts. [*Culture and Value*, p. 72.]

Page 105

607. To be sure, there is this: acquiring a knowledge of human nature; it is also possible to help someone with this, to give lessons, as it were, but one only points to cases, refers to certain traits, gives no hard and fast rules.

Page 105

608. Perhaps I can say "Just let me talk to this man, let me spend some time with him, and I shall know whether he can be trusted". And later: "I have the *impression*...". But here it's a matter of prognosis. Let the future show whether my impression was correct. Knowledge of human nature can convince us that this man is really feeling what he claims he's feeling; but does *it* convince us that other humans feel anything?

Page 105

609. "One *can't* pretend like that."--This may be a matter of experience--namely that no one who behaves like *that* will later

Page Break 106

behave in such-and-such a way; but it also may be a conceptual stipulation; and the two may be connected.

(For it wouldn't have been said that the planets *had* to move in circles, if it had never appeared *that* they move in circles). [a: Z 570a; b: Z 570c.]

Page 106

610. As I'm teaching, I can point to someone and say, "You see, *that* person isn't pretending." And a student can learn from this. But if he were to ask me "How does one really tell that?"--then I might not have anything to answer, except, perhaps, something like this: "Look how he's lying there, look at his face", and things like this.

Page 106

611. Could this be different with other beings?--If they all had the same bodies and the same facial features, for example, then there would already be a great deal of difference.

Page 106

612. And pretending is, of course, only a special case of someone's producing expressions of pain when he is not in pain. For if this is possible at all, why should it always be pretending that is taking place--which is a very specific psychological process? (And by "psychological" I don't mean "inner".) [Cf. *PI* II, xi, p. 228(f)-229.]

Page 106

613. There might actually occur a case where we should say "He *believes* he is pretending."
(*Pilgrim's Progress*: He *thinks* he is uttering the curses which the devil is uttering.) [a: *PI* II, xi, p. 229c.]

Page 106

614. Sufficient evidence passes over into insufficient without a borderline. A natural foundation for the way this concept is formed is the complex nature and the variety of human contingencies.

Then given much less variety, a sharply bounded conceptual structure would have to seem natural. But why does it seem so difficult to imagine the simplified case?

Is it as if one were trying to imagine a facial expression not susceptible of gradual and subtle alterations; but which had, say, just five positions; when it changed it would snap straight from one to another. Would this fixed smile really be a smile? And why not?--I might not be able to react as I do to a smile. Maybe it would not make me smile myself. [a, b: Z 439; c: cf. Z 527.]

Page Break 107

Page 107

615. A facial expression that was completely fixed couldn't be a friendly one. Variability and irregularity are essential to a friendly expression. Irregularity is part of its physiognomy.

Page 107

616. The importance we attach to the subtle shades of behaviour.

Page 107

617. My relation to the appearance here is part of my concept. [Z 543.]

Page 107

618. Imagine *this* argument: Pain comes in degrees. But no one will claim that I ever know the exact degree of someone else's pain; therefore it could be of the degree *o*.

But does he himself know the 'exact degree' of his own pains? And what does 'knowing' this mean?

Page 107

619. "Then does he not know how intense his pains are?" He doesn't have the slightest doubt about that.

Page 107

620. But after all, I don't know, e.g., that his pain has now eased off a little.--Oh yes I do, if he tells me. What he says is also an utterance of his pain.

Page 107

621. The uncertainty is not founded on the fact that he does not wear his pain on his sleeve. And there is not an uncertainty *in a particular case*. If the frontier between two countries were in dispute, would it follow that the country to which any individual resident belonged was dubious? [Z 556.]

Page 107

622. 'Heap of sand' is a concept without sharp boundaries--but why isn't one with sharp boundaries used instead of it?--Is the reason to be found in the nature of the heaps? What phenomenon is it whose nature determines our concept? [Cf. Z 392.]

Page 107

623. "A dog is more like a human being than a being endowed with a human form, but which behaved 'mechanically'." Behaved according to simple rules?

Page 107

624. We judge an action according to its background within human life, and this background is not monochrome, but we might picture it as a very complicated filigree pattern, which, to be sure, we can't copy, but which we can recognize from the general impression it makes.

Page Break 108

Page 108

625. The background is the bustle of life. And our concept points to something within *this* bustle.

Page 108

626. And it is the very concept 'bustle' that brings about this indefiniteness. For a bustle comes about only through constant repetition. And there is no definite starting point for 'constant repetition'.

Page 108

627. Variability itself is a characteristic of behaviour without which behaviour would be to us as something completely different. (The facial features characteristic of grief, for instance, are not more meaningful than their mobility.)†1

Page 108

628. It is unnatural to draw a conceptual boundary line where there is not some special justification for it, where similarities would constantly draw us across the arbitrarily drawn line.

Page 108

629. How could human behaviour be described? Surely only by showing the actions of a variety of humans, as they are all mixed up together. Not what *one* man is doing *now*, but the whole hurly-burly, is the background against which we see an action, and it determines our judgment, our concepts, and our reactions. [Z 567.]

Page 108

630. How could you explain the meaning of 'simulating pain', 'acting as if in pain'? (Of course the question is: *To whom?*) *Should you act it out?* And why could such an exhibition be so easily misunderstood? One is inclined to say: "Just live among us for a while and then you'll come to understand."

Page 108

631. One might surely be taught (e.g.) to mime pain (not with the intention of deceiving). But could this be taught to just anyone? I mean: someone might well learn to give certain crude tokens of pain, but without ever spontaneously giving a finer imitation out of his own insight. (Talent for languages.) (A clever dog might perhaps be taught to give a kind of whine of pain but it would never get as far as conscious imitation.) [Z 389.]

Page 108

632. I really want to say that scruples in thinking begin with (have their roots in) instinct. Or again: a language-game does not have its

Page Break 109

origin in *consideration*. Consideration is part of a language-game.

And that is why a concept is in its element within the language-game. [Z 391.]

Page 109

633. "Couldn't you imagine a further surrounding in which this too could be interpreted as pretence?"

But what does it mean to say that it might always be pretence? Has experience taught us this? How else can we be instructed about pretence? [Cf. Z 571.]

Page 109

634. Isn't there something here like the relation between Euclidean geometry and visual experience? (I mean that there is a deep-seated resemblance here.) For Euclidean geometry too corresponds to experience, only in a very peculiar way and not, say, 'merely approximately'. One might perhaps say that it corresponds as much to our method of drawing as to other things; or that it corresponds to certain requirements of *thinking*. Its concepts have their roots in widely scattered and remote areas. [To "one might perhaps say" cf. Z 572.]

Page 109

635. For just as the verb "believe" is conjugated like the verb "beat", concepts for one area are formed along the lines of very widely scattered concepts. (The genders of nouns.)

Page 109

636. The formation of a concept has, for example, the character of limitlessness, where experience provides no sharp boundary lines. (Approximation without a limit.)

637. Sometimes it seems that concepts are formed along the lines of comfortable thinking. (Just as even the yardstick is suitable not only to the things that are to be measured, but also to man.) But what the devil! Surely everyone knows whether he's in pain!--How could *everyone* know it? To do this each would have to know that all have the same.

638. A tribe has two concepts, akin to our 'pain'. One is applied where there is visible damage and is linked with tending, pity etc. The other is used for stomach-ache, for example, and is tied up with mockery of anyone who complains. "But then do they really not notice the similarity?"--Do we have a single concept everywhere where there is a similarity? The question is: Is the similarity *important* to them? And need it be so? [Z 380.]

639. If you consider the reasons someone might have for stifling pain, or simulating it, you will come up with countless ones. Now why is there this multiplicity? Life is very complicated. There are a great many possibilities. But couldn't other men disregard many of these *possibilities*, shrug them off, as it were?

640. But in that case isn't this man overlooking something that is there?--He takes no notice of it, and why should he?--But in that case his concept just is fundamentally different from ours.--*Fundamentally* different? Different.--But in that case it surely is as if his word could not *designate* the *same* as ours. Or only part of that.--But of course it must look like that, if his concept is different. For the indefiniteness of our concept may be projected for us into the *object* that the word designates. So that if the indefiniteness were missing we should also not have 'the same thing meant'. The picture that we employ symbolizes the indefiniteness. [Z 381.]

641. In philosophizing we may not *terminate* a disease of thought. It must run its natural course, and *slow* cure is all important. [Z 382.]

642. "You can never know what's going on in his soul."--That seems to be a truism. And it is, in the sense that the picture we just used already contains the sentence. But of course we have to call the sentence into question just as much as the picture.

643. The expression "Who knows what is going on inside him!" The interpretation of outer events as consequences of unknown ones, or merely surmised, inner ones. The interest that is focused on the inner, as if on the chemical structure, from which behaviour issues.

For one needs only to ask, "What do I care about inner events, whatever they are?!", to see that a different attitude is conceivable.--"But surely everyone will always be interested in *his* inner life!" Nonsense. Would I know that pain, etc., etc. is something inner if I weren't told so?

644. Doubt about an inner process is an *expression*. *Doubt*, however, is an instinctive form of behaviour. A form of behaviour toward someone else. And it does not follow from this that I know from my own experience *what* pain, etc. is; or that I know that it is something inward, and can go along with something outward. That's the last thing I know!

645. Remember: most people say one feels nothing under anaesthetic.

But some say: It *could* be that one feels, and simply forgets it completely.

If then there are here some who doubt and some whom no doubt assails, still the lack of doubt might after all be far more general. [Z 403.]

646. Or doubt might after all have a different and much less indefinite form than in our world of thought. [Z 404.]

647. Remember: we often use the phrase "I don't know" in a queer way; when, for example, we say that we don't know whether this man really feels more than that other, or merely gives stronger expression to his feeling. In that case it is not clear what sort of investigation would settle the question. Of course the expression is not quite idle: we want to say that we certainly can compare the feelings of A and B with one another, but that the circumstances of a

comparison of A with C throw us out. [Z 553.]

Page 111

648. Only God sees the most secret thoughts. But why should these be all that important? And need all human beings count them as important? [Z 560.]

Page 111

649. "Imagine humans who only think aloud." After all, it is not a matter of course that beings of bodily nature think; so let them think only talking, that is, let them do nothing else that we would call thinking. (Their secret thoughts are monologues.)

Page 111

650. The steps that lie between instinctive cunning and cunning that is carefully thought out. An idiot could behave slyly, for that's what we'd call it, but we wouldn't think him capable of *planning* anything.

If we're asked "What's going on inside him?" we say, "Surely very little goes on inside him." But what do we know about it?! We construct a picture of it according to his behaviour, his utterances, his ability to think.

Page 111

651. We combine diverse elements into a 'Gestalt' (pattern), for example, into one of deceit.

The picture of the inner completes the Gestalt.

Page 111

652. If a concept depends on a pattern of life, then there must be some indefiniteness in it. For if a pattern deviates from the norm, what we want to say here would become quite dubious.

Page Break 112

Page 112

653. Thus can there be definiteness only where life flows quite regularly? But what do they do when they come across an irregular case? Maybe they just shrug their shoulders.

Page 112

654. "He told me--and there was not the slightest possibility of doubting his credibility--that..." Under what circumstances is there no possibility of doubting his credibility? Can I specify them? No.

Page 112

655. You must think about the purpose of words.

What does language have to do with pain?

Page 112

656. In the case that I have in mind, the people have a word which has a similar purpose (with a similar function) to that of the word "pain". It would be wrong to say that it "designates" something similar. It enters into their life in a different, and yet similar, way.

Page 112

657. "But you can't recongize [[sic]] pain with *certainly* just from externals."--The *only* way of recognizing it is by externals, and the uncertainty is constitutional. It is not a shortcoming.

It resides in our concept that this uncertainty exists, in our instrument. Whether this concept is practical or impractical is really not the question.

Page 112

658. In a world different from ours colours might play a different role. Think of various cases

(1) Certain colours are tied to certain forms. Circular shapes, red, rectangular ones, green, etc.

(2) Dyes can't be produced. You can't colour things.

(3) *One* colour always linked together with a foul smell, or poisonousness.

(4) A far greater incidence of colour-blindness than now exists.

(5) Different shades of grey abound; all other colours are extremely rare.

(6) We can reproduce a great many shades of colour from memory. If our number system is connected with the number of our fingers, then why shouldn't our system of colours be connected with the specific ways in which they occur.

(7) A colour occurs only in gradual transition into another one.

(8) Colours always occur in the sequence of colours in the rainbow.

Page Break 113

Page 113

659. Think of the uncertainty about whether animals, particularly lower animals, such as flies, feel pain.

The uncertainty whether a fly feels pain is philosophical; but couldn't it also be instinctive? And how would that come out?

Indeed, aren't we really uncertain in our behaviour towards animals? One doesn't know: Is he being cruel or not.

Page 113

660. For there *is* uncertainty of behaviour which doesn't stem from uncertainty in thought.

Page 113

661. Look at the problem of uncertainty as to whether someone else is feeling pain in light of the question whether an insect feels pain.

Page 113

662. There is such a thing as trust and mistrust in behaviour!

If anyone complains, e.g., I may be trustful and react with perfect confidence, or I may be uncertain, like someone who has his suspicions. Neither words nor thoughts are needed for this. [Z 573.]

Page 113

663. The unpredictability of human behaviour. But for this--would one still say that one can never know what is going on in anyone else? [Z 603.]

Page 113

664. But what would it be like if human behaviour were not unpredictable? How are we to imagine this? (That is to say: how should we depict it in detail, what are the connections we should assume?) [Z 604.]

Page 113

665. "I don't know what's going on inside it right now!" That could be said of the complicated mechanism say of a fine clock, which triggers various external movements according to very complicated laws. Looking at it one might think: if I knew what it looked like inside, what was going on right now, I would know what to expect.

Page 113

666. But with a human being, the assumption is that *it is impossible* to gain an insight into the mechanism. Thus indeterminacy is postulated.

Page 113

667. If, however, I doubt whether a spider feels pain, it is not because I don't know what to expect. [Z 564.]

Page Break 114

Page 114

668. But we cannot get away from forming the picture of a mental process. And *not* because we are acquainted with it in our own case! [Z 565.]

Page 114

669. *One* kind of uncertainty is that with which we might face an unfamiliar mechanism. In another we should possibly be recalling an occasion in our life. It might be, e.g., that someone who has just escaped the fear of death would shrink from swatting a fly, though he would otherwise do it without thinking twice about it. Or on the other hand that, having this experience in his mind's eye, he does with hesitancy what otherwise he does unhesitatingly. [Z 561.]

Page 114

670. Even when I 'do not rest secure in my sympathy' I need not think of uncertainty about his later behaviour. [Z 562.]

Page 114

671. The one uncertainty stems from you, so to speak, the other from him.

The one could surely be said to connect up with an analogy, then, but not the other. Not, however, as if I were drawing a conclusion from the analogy! [Z 563.]

Page 114

672. Seeing life as a weave, this pattern (pretence, say) is not always complete and is varied in a multiplicity of ways. But we, in our conceptual world, keep on seeing the same, recurring with variations. That is how our concepts take it. For concepts are not for use on a *single* occasion. [Z 568.]

Page 114

673. And the pattern in the weave is interwoven with many others. [Z 569.]

Page 114

674. I *say* for instance: "He might after all be pretending."--What am I *imagining* when I say it?--That is, what explanation of the word "pretend" would I give? What kind of examples would come to mind?

Page 114

675. How do I *employ* the sentence?

(For the situation here is like certain areas of mathematics, where there is a 'fantastic application'.)

Page 114

676. I evoke a picture which can then serve a purpose. (I could almost be looking at a painted picture.)

Page 114

677. Sometimes I treat him as I treat myself and as I would like to be treated when I'm in pain; sometimes I don't.

Page Break 115

Page 115

678. We're used to a particular classification of things.

With language, or languages, it has become second nature to us.

Page 115

679. These are the fixed rails along which all our thinking runs, and so our judgement and action goes according to them too. [Z 375.]

Page 115

680. Must people be acquainted with the concept of modesty or of swaggering, wherever there are modest and swaggering men? Perhaps nothing hangs on this difference for them.

For us, too, many differences are unimportant, which we might find important. [Z 378.]

Page 115

681. And others have concepts that cut across ours. And why should their concept 'pain' not split ours up? [First sentence: Z 379. Second sentence: Z 380, the last sentence.]

Page 115

682. The 'uncertainty' relates not to the particular case, but to the method, to the rules of evidence. [Z 555.]

Page 115

683. Concepts with fixed limits would demand a uniformity of behaviour. But what happens is that where I am *certain*, someone else is uncertain. And that is a fact of nature. [Z 374.]

Page 115

684. If it is said, "Evidence can only make it probable that expressions of emotions are genuine", this does *not* mean that instead of complete certainty we have just a more or less confident conjecture. "Only probable" cannot refer to the degree of our confidence, but only to the nature of its justification, to the character of the language-game. Surely this must help determine the constitution of our concepts: that there is no agreement among men as to the certainty of their convictions. (Compare the remark about agreement in colour-judgments and agreement in mathematics.)

Page 115

685. Given the same evidence, one person can be completely convinced and another not be. We don't on account of this exclude either one from society, as being unaccountable and incapable of judgment.

Page 115

686. But mightn't a society do precisely this?

Page Break 116

Page 116

687. For words have meaning only in the stream of life. [Cf. Z 173, the last sentence.]

Page 116

688. I am sure, *sure*, that he isn't pretending; but someone else isn't. Can I convince him? And if not--do I say that he can't think? (The conviction could be called "intuitive".) [Cf. *PI* II, xi, p. 227f.]

Page 116

689. Instinct comes first, reasoning second. Not until there is a language-game are there reasons.

Page 116

690. Am I saying something like, "and the soul itself is merely something about the body"? No. (I am not that hard up for categories.)

Page 116

691. You can vary the concept, but then you might change it beyond recognition.

Page 116

692. Even if we vary the concept of pretence, its inwardness must still be kept, i.e. the possibility of a confession. But we don't always have to believe a confession, and a false confession is not necessarily deception.

Page 116

693. Concepts other than though akin to ours might seem *very* queer to us; namely, a deviation from the usual in an unusual *direction*. [Z 373.]

Page 116

694. "You're all at sea!" we say, when someone doubts the genuineness of something we recognize as clearly genuine.

"You're all at sea"--but we cannot prove anything. [Cf. *PI* II, xi, p. 227g.]

695. Soulful expression in music--this cannot be recognized by rules. Why can't we imagine that it might be, by other beings? [Z 157.]

696. It would make a strange and strong impression on us were we to discover people who knew only the music of music boxes. We would perhaps expect gestures of an incomprehensible kind, to which we wouldn't know how to react.

697. "The genuineness of an expression cannot be proved." "One has to feel it." But what does one go on to do with this now? If someone says "Voilà, comment s'exprime un coeur vraiment épris", and if he

also converts someone to his viewpoint,--what are the further consequences?

In a vague way consequences can be imagined. The other one's attention gets a new direction. [Cf. *PI* II, xi, p. 228a.]

698. Can we imagine that something unprovable to us could be proved to other beings?

Or would that change its nature to the point of its being unrecognizable?

699. What is essential for us is, after all, spontaneous agreement, spontaneous sympathy.

700. 'These men would have nothing human about them.' Why?--We could not possibly make ourselves understood to them. Not even as we can to a dog. We could not find our feet with them.

And yet there surely could be such beings, who in other respects were human. [Z 390.]

701. "But no one can *know* it. One can *believe* it. Believe it with all his heart, but not know it." Then the difference is *not* to be found in the certainty of the one who is convinced.

It must be found elsewhere; in the *logic* of the question.

702. Imagine that people could observe the functioning of the nervous system in others. In that case they would have a sure way of distinguishing genuine and simulated feeling.--Or might they after all doubt in turn whether someone feels anything when these signs are present?--What they see there could at any rate readily be imagined to determine their reaction without their having any qualms about it.

And now this can be transferred to outward behaviour. [Z 557a, b.]

703. There is indeed the case where someone later reveals his inmost heart to me by a confession: but that this is so cannot offer me any explanation of outer and inner, for I have to give credence to the confession.

For confession is of course something exterior. [Z 558.]

704. Men who could see the functioning of the nerves: Do I *have* to suppose that even they could be outwitted by the 'inner'? But that means: Can't I imagine outward signs which would seem to be sufficient for making a *sure* judgment about 'the inner'?

705. But now say: "Someone could still be feeling something even if the physiological signs ran completely to the contrary." Well then anyone who is unfamiliar with *these* scruples simply has a different concept.

706. Imagine that the people of a tribe were brought up from early youth to give no expression of feeling of *any* kind. They find it childish, something to be got rid of. Let the training be severe. 'Pain' is not spoken of; especially not in the form of a conjecture "Perhaps he has got...". If anyone complains, he is ridiculed or punished. There is no such thing as the suspicion of shamming. Drilling someone to speak expressionlessly, in a monotone, to move mechanically. [Except for the last sentence: Z 383.]

707. I want to say: an education quite different from ours might also be the foundation for quite different concepts. [Z 387.]

Page 118

708. For here life would run on differently.--What interests us would not interest *them*. Here different concepts would no longer be unimaginable. In fact, this is the only way in which essentially different concepts are imaginable. [Z 388.]

Page 118

709. That the evidence makes someone else's feelings merely probable is not what matters to us; what we are looking at is the fact that *this* is taken as evidence for something; that we construct a statement on *this* involved sort of evidence, and hence that *such* evidence has a special importance in our lives and is made prominent by a concept. [Cf. Z 554.]

Page 118

710. "Shamming," these people might say, "What a ridiculous concept!" [Z 384, first sentence.]

Page 118

711. Steadfast faith (in an annunciation, for instance)--is it less certain than being convinced of a mathematical truth?--(But this makes the language-games more alike!) [*Culture and Value*, p. 73.]

Page 118

712. Might not the attitude, the behaviour, of trusting, be quite universal among a group of humans? So that a doubt about manifestations of feeling is quite foreign to them? [Z 566.]

Page 118

713. But consider: Why should a person have to be dissimulating, aren't there other possibilities? Can't he be dreaming? Can't the matter get confused along different lines? (*Couvade*.)

Page Break 119

Page 119

Just think of how often we can't say: someone is honest or dishonest, sincere or insincere. (A politician, for example.) Well-meaning or the opposite. How many foolish questions get asked here! How often *the concepts don't fit!*

Page 119

714. It is important for our considerations that there are people of whom someone feels that he will never know what's going on inside them. That he'll never understand them. [*Culture and Value*, p. 74.]

Page 119

715. We are certainly *inclined* to say that a complaint is merely a sign, a symptom of a different phenomenon, the important one, which is only empirically related to it. And even if we are mistaken here, still there must be a reason for this strong temptation, a reason within the law of the evidence we admit. †1

Page 119

716. One might raise the question: What does the law of admissible evidence have to be like for this conception to suggest itself to us?

Page 119

717. One would like to answer: the evidence would have to be fluctuating. Multifform?

Page 119

718. There is such a thing as feigned expression; but there must also be such a thing as evidence for the pretence.

Even though we often simply don't know what to say, all the same we do sometimes have to lean towards one opinion, and sometimes be quite certain.

So the outward has to be evident. †2

Page 119

719. You say you attend to a man who groans because experience has taught you that you yourself groan when you feel such-and-such. But as you don't in fact make any such inference, we can abandon the justification by analogy. [Z 537.]

Page 119

720. In philosophy it is significant that such-and-such a sentence makes no sense; but also that it sounds funny. [Z 328.]

Page 119

721. Can 'knowing one's way about' be called an experience? Surely not. But there are experiences characteristic of the condition of knowing one's way about and not knowing one's way about. (Not knowing one's way about and lying.) [Z 516.]

722. Is "I hope..." a description of a state of mind? A state of mind has duration. So if I say "I have been hoping for the whole day...", that is such a description. But suppose I say to someone: "I hope you come"--what if he asks me "For how long have you been hoping that?" Is the answer "For as long as I've been saying so"? Supposing I had some answer or other to that question, would it not be quite irrelevant to the purpose of the words "I hope you'll come"? [Z 78.]

723. A cry is not the description of a state of mind, even though a state of mind can be inferred from it. [Cf. *PI* II, ix, p. 189b, c.]

724. One doesn't shout "Help" because he observes his own state of fear.

725. 'Describing' includes 'attending'.

726. These sentences are descriptions: "I'm less afraid of him now than before", "For a long time I've been wishing...", "I keep on hoping...". (One is describing a way something has been running on.)

727. Do I want to say, then, that certain facts are favourable to the formation of certain concepts; or again unfavourable? And does experience teach us this? It is a fact of experience that human beings alter their concepts, exchange them for others when they learn new facts; when in this way what was formerly important to them becomes unimportant, and *vice versa*. (It is discovered, e.g., that what formerly counted as a difference in kind, is really *only* a difference in degree.)

((Re: discussion of the concept of colour and other things.)) [a: Z 352.]

728. If a cry is not a description, then neither is the verbal expression that replaces it. The utterances of fear, hope, wish, are not descriptions; but the sentences "I'm less afraid of him now than before", "For a long time I've been wishing ...", ... are descriptions.

729. What is the past tense of "You are coming, aren't you!"?†1 [Z 80.]

730. The tangled use of psychological words ("think", for example). As if the word "violin" referred not only to the instrument, but sometimes to the violinist, the violin part, the sound, or even the playing of the violin.

731. "If p occurs, then q occurs" might be called a conditional prediction. That is, I make *no* prediction for case not-p. But for that reason what I say also remains unverified by "not-p and not-q".

Or even: there are conditional predictions and "p implies q" is *not* one. [Z 681.]

732. I will call the sentence "If p occurs then q occurs" "S".--"S or not S" is a tautology; but is it (also) the law of excluded middle?--Or again: If I want to say that the prediction "S" may be right, wrong, or undecided, is that expressed by the sentence "not (S or not-S)"? [Z 682.]

733. The use of the words "look at", "observe". And then the use of the expression "to look at oneself"!

734. "I'm afraid of him" and "I tend to fear him". But the expression "I tend to..." could mean *several things* here. There could be a language in whose conjugations *many* more differences are taken care of than in the languages we know.

735. Difference in *purpose* between the utterance of fear "I'm afraid!", and the report of fear "I'm afraid".

736. "To know" can mean something like "to be able to" (to know by heart, e.g.), or it can mean something like "to be sure".

737. No one but a philosopher would say "I know that I have two hands"; but one may well say: "I am unable to doubt that I have two hands."

"Know", however, is not ordinarily used in this sense. [a: Z 405; b: Z 406, first sentence.]

Page Break 122

Page Break 123

APPENDIX

Correspondences between Remarks in TS 232 and in *Zettel, Philosophical Investigations* and *Vermischte Bemerkungen (Culture and Value)*.

Page 123

TS 232 und Zettel

Correspondences

Page 123

TS 232	Z
4	79
15	469a
19	468
20	113
26	618
45 (Ende)	85
46	87
48	84
50	81
51	82
52	83
57	72
58	473
59	474
60	475
61	476
63	472, 483, 621
64	622a
65	623
66	624 Anfang
70	625a
71	625b
72	626
77a	629
80a	Vgl. 627
87a, b, c	630, 631
88b	632
89	633 Anfang
98	634
100	635

Page Break 124

Page 124

TS 232	Z
105	Vgl. 677
110	636
111	637
112	638
113 (der erste Satz)	640
119b	643
123	641

124	642
137	644
138	645
139b	646
140 (der erste Satz)	647
143	535
148	488, 489, 490, 491, 492
150a	Vgl. 532, 533
151	534
152	Vgl. 504
158	500
159	512
161a	501
166a, b	523
167	Vgl. 525
172	Vgl. 496
174	Vgl. 502
178 (die ersten drei Sätze)	45
183	100
184	101
186	Vgl. 102
187	103
192b, c	Vgl. 129
194a, b	Vgl. 113; 112
200	114
201	117
202	118
203	Vgl. 98
205	Vgl. 99
206 (der letzte Satz)	115
207	116
212	Vgl. 89b
214	109
215	Vgl. 122
220	110
224 (Ende)	104

Page Break 125

Page 125

TS 232	Z
225	105
226	106
227	107
233	95
236	90
237	91
248	93
249	Vgl. 94
253b	Vgl. 88
257b	96
258	50
259	Vgl. 6
261	Vgl. 124
263a	92a
264	Vgl. 188
267b, c	586
269	Vgl. 587

300	Vgl. 406
303	408a, c
307c	511
308	518
309	519
310	520
311	465
312a, b, c	421
313	432
315	422
316	423
317	424
318	425, 417
320	513
324	526
325	495
326	418
327	419
330 (Ende)	420
331	119
332	120
333	524 (die ersten zwei Sätze)
336	411
337	412
338	413
339	414

Page Break 126

Page 126

TS 232	Z
340	415
341	416
343	409, 410
346	660
348	366
349	367
351	657
352	658
353	659
355	Vgl. 208
392	350
393	351
395	330
403	Vgl. 300
404	301
405	302
406	303
407	304
408	305
409	306
410	307
411	308
413	318
414	319
423	354
424	355
425	356

426	357
427	358
428 (die ersten zwei Sätze)	359
429	362
431	363
432	364
433a	365
437b	353
466	162
467	163
468	164
469	165
470	166
471	167
497	159
498	515, 484

Page Break 127

Page 127

TS 232	Z
499	485
500	168
501	169, 170
502	171
503	172
504	173
505	174
512	673
520	674
521	216
522	217
531	179
548b, c	185
557	182
570	Vgl. 225
571a	Vgl. 183a
572	184
573	180
574a, b	181
575	1, 2b
578	Vgl. 183a
579	Vgl. 183b
582	44
583	661
592	662
593	663
594	664
595	665
596	666
597	667
598	192
605	393
609	570a, c
614	439; vgl. 527
617	543
621	556
622	Vgl. 392

629 567
631 389
632 391
633 Vgl. 571
634 (Anfang) Vgl. 572
638 380

Page Break 128

Page 128

TS 232	Z
640	381
641	382
645	403
646	404
647	553
648	560
662	573
663	603
664	604
667	564
668	565
669	561
670	562
671	563
672	568
673	569
679	375
680	378
681	379, 380 (der letzte Satz)
682	555
683	374
687	Vgl. 173 (der letzte Satz)
693	373
695	157
700	390
702	557a, b
703	558
706	383
707	387
708	388
709	Vgl. 554
710	384 (der erste Satz)
712	566
719	537
720	328
721	516
722	78
727a	352
729	80
731	681
732	682
737	405, 406 (der erste Satz)

Page Break 129

TS 232 und *Philosophische Untersuchungen*

Page 129

Correspondences

TS 232	PU
36	II, xi, S. 200e
358	II, xi, S. 209b
416	Vgl. II, x, S. 192e
419	II, x, S. 191f
434	Vgl. II, xii, S. 230c
445	Vgl. II, xi, S. 210-211
446	II, xi, S. 211a
449	Vgl. II, xi, S. 207b
451	Vgl. II, xi, S. 207e
452	II, xi, S. 200a
453	Vgl. II, xi, S. 200b
463	II, xi, S. 198d
472	II, xi, S. 212f
483b	Vgl. II, xi, S. 208e
484	II, xi, S. 208e
485	II, xi, S. 208f
486	II, xi, S. 209a
488	II, xi, S. 213b
489	Vgl. II, xi, S. 214f
491	Vgl. II, xi, S. 213a
492	Vgl. II, xi, S. 208b
494	II, xi, S. 213c
495	II, xi, S. 213d
519	II, xi, S. 210e
526	II, xi, S. 195d
535	Vgl. II, xi, S. 206d, e
538	II, xi, S. 208c
543	Vgl. II, xi, S. 213c
546	II, xi, S. 212d
556a	Vgl. II, xi, S. 193a
566	Vgl. II, xi, S. 224c
567a	II, xi, S. 224d
569	II, xi, S. 223g
612	Vgl. II, xi, S. 228f-229
613a	II, xi, S. 229c
688	Vgl. II, xi, S. 227f
694	Vgl. II, xi, S. 227g
697	Vgl. II, xi, S. 228a
723	Vgl. II, ix, S. 189b, c

*TS 232 und Vermischte Bemerkungen**Correspondences*

TS 232 VB	
155b	S. 125 ("Wir sagen in einer wissenschaftlichen Untersuchung...")
606	S. 139 ("Worin liegt die Wichtigkeit...")
711	S. 142 ("Der feste Glaube...")
714	S. 142 ("Es ist für unsre Betrachtung wichtig...")

FOOTNOTES

- †1 Cf. *Notebooks* 12.9.1916. (*Eds.*)
- Page 9
- †1 The typescript contains no figure. We have taken it from the corresponding manuscript. (*Eds.*)
- Page 9
- †2 *Ibid.* (*Eds.*)
- Page 15
- †1 Wittgenstein crossed out the word "understanding" in the MS. and replaced it with "imaging". In *Zettel* too the pair of words is "seeing"--"imaging". (*Eds.*)
- Page 16
- †1 This remark is also numbered 83. We have corrected the numbering. (*Eds.*)
- Page 18
- †1 Cf. *Philosophical Investigations* I, §§350-351. (*Eds.*)
- Page 19
- †1 Var. "But even if the curtain over there obeyed my will, so that it moved or disappeared".
- Page 20
- †1 Var. "In the above case the assertion that that conditional sentence is true, or false, should not amount to the assertion that p will occur."
- Page 21
- †1 Var. "the picture before the inner eye".
- Page 23
- †1 Var. "For me, what is on this screen now represents this."
- Page 26
- †1 In the typescript, "chase". In the MS, "check-mate". This seems to be more natural here. (*Eds.*)
- Page 26
- †2 In the typescript, "chasing", in the MS "check-mating". (*Eds.*)
- Page 27
- †1 Var. "as when following nature."
- Page 29
- †1 Var. "the mouth". Cf. *PI* I, 583.
- Page 34
- †1 Var. "not as a natural sound, but rather to communicate something, as a report".
- Page 36
- †1 Var. "And how is one to decide how exact the analogy must be for us to have the right to use the concept 'thinking' with these people, a concept which has its home in *our* life?"
- Page 38
- †1 Var. "could not be deduced from".
- Page 39
- †1 *Philosophical Investigations* I, §2.
- Page 40
- †1 Var. "He just learns the use of the word *under particular circumstances.*"
- Page 41
- †1 In the typescript, as well as in the manuscript, this is given erroneously as "Barnard". Cf. *PI* I, 342. (*Eds.*)
- Page 42
- †1 We have taken the drawing from the MS. (*Eds.*)
- Page 45
- †1 Var. "make sense".
- Page 46
- †1 Manuscript: "animated conversation". (*Eds.*)
- Page 47
- †1 Var. "guesses".
- Page 47
- †2 Var. "which often illustrate it, as it were, are not the intention itself."
- Page 48
- †1 At this point the MS has: "Schubert is my name, Schubert I am." (*Eds.*)
- Page 66
- †1 At this point there is no letter in the typescript. We have taken the figure from the MS. (*Eds.*)
- Page 67

†1 In the MS, "Imagine". (*Eds.*)

Page 68

†1 The manuscript has "indications". (*Eds.*)

Page 71

†1 There is no figure in the typescript. We have copied this figure from the manuscript. (*Eds.*)

Page 73

†1 In the MS there is a drawing at this point:

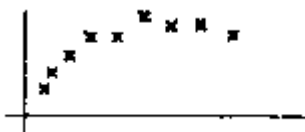

(*Eds.*)

Page 73

†2 In the MS there is a drawing at this point:



(*Eds.*)

Page 74

†1 There is no drawing in the typescript. We have copied the drawing from the manuscript. (*Eds.*)

Page 78

†1 Perhaps as an error, the typescript has: "It is obvious at a picture". (*Eds.*)

Page 83

†1 There is no letter at this point in the typescript. We have taken it from the manuscript. (*Eds.*)

Page 85

†1 Var. "But still this expression tells you '*what happened*' only if you are at home in the special conceptual world that belongs to these situations (and this holds for the speaker too)."

Page 88

†1 There is no picture in the typescript. We have taken it from the manuscript. (*Eds.*)

Page 92

†1 We have copied the letter following the manuscript. (*Eds.*)

Page 92

†2 In the MS: "See  as  "? (*Eds.*)

Page 95

†1 Here there is no symbol in the typescript. We have taken it from the manuscript. (*Eds.*)

Page 108

†1 Var. "are not more important for our reaction than...".

Page 119

†1 Var. "still the reason for this mistake must be within the law of evidence that we admit."/"still the mistake must have a reason, and that in the nature of the evidence which we admit."

Page 119

†2 In the MS: "evidence". (*Eds.*)

Page 120

†1 Var. "You will come, won't you!"

LAST WRITINGS ON THE PHILOSOPHY OF PSYCHOLOGY: *Volume 1*

Page Break ii

Titlepage

LAST WRITINGS ON THE PHILOSOPHY OF PSYCHOLOGY

Ludwig Wittgenstein

VOLUME I

Preliminary Studies for Part II
of Philosophical Investigations

Edited by
G. H. VON WRIGHT
and
HEIKKI NYMAN

Translated by
C. G. LUCKHARDT
and
MAXIMILIAN A. E. AUE

Basil Blackwell

Copyright page

Copyright © Blackwell Publishers Ltd 1982, 1990

First published 1982
First published in paperback 1990
Reprinted 1998

Blackwell Publishers Ltd
108 Cowley Road
Oxford OX4 1JF
UK

All rights reserved. Except for the quotation of short passages for the purposes of criticism and review, no part of this publication may be reproduced, stored in a retrieval system, or transmitted, in any form or by any means, electronic, mechanical, photocopying, recording or otherwise, without the prior permission of the publisher.

Except in the United States of America, this book is sold subject to the condition that it shall not, by way of trade or otherwise, be lent, resold, hired out, or otherwise circulated without the publisher's prior consent in any form of binding or cover other than that in which it is published and without a similar condition including this condition being imposed on the subsequent purchaser.

British Library Cataloguing in Publication Data

Wittgenstein, Ludwig
Last writings on the Philosophy of Psychology
Vol. I
I. Philosophy
I. Title. II. Wright, G. H. von III. Nyman, Heikki
192 B3376.W564
ISBN 0-631-12895-6

Page Break iv

EDITORS' PREFACE

Page iv

Unlike the two volumes of Wittgenstein's *Remarks on the Philosophy of Psychology* (*RPP*), these two volumes of last writings on the philosophy of psychology are not based on typescripts. (Cf. the Preface to volume I of *RPP*.) Their subject matter, however, is by and large the same.

Page iv

The first of these volumes consists of writings dating from the period between 22 October 1948 and 22 March 1949, except for the last remark, which is dated 20 May. This material is a continuation of the manuscript writings on which the typescript for volume II of *RPP* is based. So far as is known, Wittgenstein did not prepare a typescript for this material. In the spring of 1949, however, he probably made a handwritten clean copy of a selection of all of his remarks written between 1946 and 1949 concerning topics in the philosophy of psychology (MS 144), and then prepared a typescript on the basis of this new manuscript. This was the typescript for Part II of the *Philosophical Investigations*. (Unfortunately, it was lost after the book was printed.) More than half of the remarks in this typescript--and therefore also in the second part of the *Philosophical Investigations*--are taken from the manuscripts written between October 1948 and March 1949. These manuscripts, the second half of MS 137 and MS 138, appear here in their totality, with the exception of a sizeable number of remarks of a general nature which have almost all been printed in *Culture and Value*. For the most part, those remarks of a general nature had been clearly separated by parallel lines || from the remainder of the text by Wittgenstein himself.

Page iv

Since the text published in this first volume of late writings is based directly on the manuscripts and not on a typescript prepared by the author on the basis of manuscripts, it is of a more provisional and improvised nature than the *Remarks on the Philosophy of Psychology*. (For this reason we did not want to publish it as the third volume of those *Remarks*.) There are frequent repetitions; sometimes a whole remark will reappear, virtually word for word. If Wittgenstein had ever dictated a typescript based on these manuscripts, he would certainly have avoided such repetitions and would also have made many other changes. The number of variants too is much larger than in the typescripts upon which *RPP* is based. In general, the editors have ventured to make a choice between the variants; when we were not sure we quoted the variant(s) in a footnote.

Page iv

A reminder to the reader: words in angle brackets < > in the text are editorial additions. The numbering of the remarks and most footnotes as well as the cross-references to Wittgenstein's published works have also been added by the editors. These cross-references

Page Break v

are given in square brackets. Occasional footnotes added by the translator are identified by (*Tr*).

Page v

We would like to thank Dr Joachim Schulte as well as the two translators, Professor C. G. Luckhardt and Professor Maximilian A. E. Aue, for their valuable advice and suggestions which greatly aided us in preparing a correct text.

Helsinki

Georg Henrik von Wright

Heikki Nyman

Page Break 1

Preliminary Studies for Part II of *Philosophical Investigations* MSS 137-138 (1948-1949)

Page 1

Page Break 2

Page 2

1. A language in which there is a word "to frightle oneself"; meaning: to torture oneself with fearful thoughts. And

then you might suppose, for example, that this verb had no first person present. The English "I am ... ing".

Page 2

2. If I tell someone "I hope you'll come", is it less urgent if my hoping lasted only for 30 seconds than if it had lasted 2 minutes?

"I'm happy that you brought it off!"--"How long have you been happy?" A peculiar question. But it might make sense. The answer might be: "Whenever I think about it", or "At first I wasn't happy about it, but then I was" or "I keep on thinking about it and being happy" or "It only occurs to me every once in a while, but when it does, I'm happy", etc. One also says "It's a source of continual happiness to me", and "For a second I was happy about his bad luck".

Page 2

3. "I'm moving my bishop."--"How long are you moving it?"

Page 2

4. Think about this as an example of the propositional form "If p, then q": "If he comes, I'll tell him." Now if he *doesn't* come--have I kept my promise?--have I broken it?--

But can one say that that proposition asserts a 'connection'? Would I answer "This doesn't *have* to be the case"? It's not as if the sentence had been: "If *these* two get together there will be a brawl." Here one could answer that way.

Page 2

5. But suppose it was the material implication that was being asserted (and the case does exist!)--can I also respond to " $p \supset q$ " by saying "It doesn't have to be the case"? And what does that mean here?

Page 2

6. "If the two terminals approach each other a spark jumps across."--What is taken as a verification of this proposition? The observation that they never approach each other?--Can what we want to say here be expressed by material implication? Certainly not; but maybe by 'formal' implication? That's just as wrong.--What we want to state is a kind of natural law; it is easy enough to imagine the kind of observation that leads to this. One has observed *that* a spark jumps across every time they approach each other.--Is the proposition perhaps of the type " $(x).\phi x \supset \psi x:(\exists x).\phi x$ "? If not, then *this* proposition must itself have an application, even if it isn't the same one.

Page Break 3

Page 3

7. "If he comes I'll tell him..." is a *resolution*, a *promise*. If it is not to be a false promise it must not rest on the certainty that he won't come. It is neither a material nor a formal implication.

Page 3

8. In a conditional prediction in science one could distinguish between *justification* and *correctness*. One could call it "justified" if it follows, results from, a theory that has such-and-such grounds. So if the first part of the sentence isn't true, one can then say: *Had* it been true, then... *would* have.... But the fact that the first part did not turn out to be true doesn't give me the right to say that.

Page 3

9. Does a proposition such as "All bodies move..." (Law of Inertia) have to be expressed in the form "if-then"? "If something is a body then it moves----."--Or does it have to be expressed: "There are bodies; and if something is a body, then..."? (Nobody would think of putting it that way.)

Page 3

10. Obviously we could have *one* concept of fear to be applied only to animals, and the word for that concept wouldn't have a first person.

The third person would be used quite like the third person of "to fear".

Page 3

11. Remember that the subjunctive makes no sense except in a conditional sentence. If someone says "I *would* have won this game", he will be asked: "If -- ?"

Page 3

12. [Ref. 'to fear', etc.] Nothing is more difficult than to look at concepts without prejudice. For prejudice is a kind of understanding. And to forego it, when it is so full of consequences for us, --.

Page 3

13. The English "I'm furious" is not an expression of self-observation. Similarly in German "Ich bin wütend"; but not "Ich bin zornig". ("Terribly doth the rage within my bosom turn...". It is a trembling of rage.)

Page 3

14. We ask "What does 'I am frightened' really mean? What am I thinking when I say it?" And, of course, we find no answer, or only one that is obviously inadequate.

The question is: "In what sort of context does it occur?" [Cf. *Philosophical Investigations* II, ix, p. 188b]

Page Break 4

Page 4

15. One could also say with a certain amount of justification: "I simply say it." For this just means: Don't worry about something accompanying speech.

Page 4

16. Now can't the utterance appear in various connections? which first give it one face, then another?

Page 4

17. I say "I am afraid...", someone else asks me "What did you want to say when you said that? Was it like an exclamation; or were you alluding to your state within the past few hours; did you simply want to tell me something?" Can I always give him a clear answer? Can I never give him one?--Sometimes I shall have to say: "I was thinking about how I spent the day today and I shook my head, vexed with myself, as it were"--but other times: "It meant: Oh, God! If I just weren't so afraid!"--Or: "It was just a cry of fear"--or: "I wanted you to know how I feel." Sometimes the utterance is really followed by such explanations. But they can't *always* be given. [Up to "Sometimes I shall have to say", cf. *PI* II, ix, p. 187g]

Page 4

18. It would be possible to imagine people who as it were thought much more definitely than we, and used a number of different words, now one, now another. [Cf. *PI* II, ix, p. 188a]

Page 4

19. Nothing is more important for teaching us to understand the concepts we have than constructing fictitious ones. [*Culture and Value (C & V)*, p. 74]

Page 4

20. "What is fear?"--"Well, the *manifestations* and occasions of fear are as follows: - - -"--"What does 'to be afraid' mean?"--"The expression 'to be afraid' is used in *this* way: - - -'.

"Is 'I am afraid - - -' therefore a description of my state?" It can be used in such a connection and with such an intention. But if, for example, I simply want to tell someone about my apprehension, then it is not that kind of description.

Page 4

21. "I'm afraid" can, for instance, be said just as an explanation of the way I'm behaving. In that case it's far from being a groan; it can even be said with a smile.

Page Break 5

Page 5

22. We ask, "What does 'I am frightened' really mean, what am I referring to when I say it?" And, of course, we find no answer, or one that is inadequate.

The question is: "In what sort of context does it occur?" [*PI* II, ix, p. 188b; cf. remark 14]

Page 5

23. One can find no answer if one tries to settle the question "What am I referring to", "What am I thinking when I say it", etc. by pronouncing the words and at the same time attending to myself, as it were observing my soul out of the corner of my eye. In an actual case I can indeed ask: "Why did I say that, what did I mean by it?" and I might answer the question too, but not on the ground of observing what accompanied the speaking. And my answer would supplement, paraphrase, the earlier utterance. [*PI* II, ix, p. 188c]

Page 5

24. What is fear? What does "being afraid" mean? If I wanted to define it at a *single* showing--I should *play-act* fear. [*PI* II, ix, p. 188d]

Page 5

25. Could I also represent hope in this way? Hardly. And what about belief? [*PI* II, ix, p. 188e]

Page 5

26. "I believe he will come."

"I tell myself time and time again: 'He will come'." For the latter, people might have a separate verb.

Page 5

27. Describing my state of mind (of fear, say) is something I do in a very particular context. (Just as it takes a particular context to make a certain action into an experiment.)

Is it, then, so surprising that I use the same expression in different games? And sometimes as it were between the games?

"I thought of him" and "I thought about him" surely mean very different things. [a, b: *PI* II, ix, p. 188f]

28. And do I always talk with very definite purpose?--And is what I say meaningless because I don't? [*PI II*, ix, p. 188g]

29. <In English> "Now you mention it: I think he'll come."
"Now I think you're right: he will come."
"No. I'm convinced: he will come." One can think up a

characteristic context for all such expressions.

30. What is necessary in order for one to be describing a mental state?--Or might I ask: What is necessary in order for one to be *trying* to describe a mental state?

31. One might also ask: "What must then be important to me?"

32. "I wanted to describe my mental state to you"--as opposed, perhaps, to: "I merely wanted to vent my feelings". I wanted him to know 'how I am feeling'. (In this context one often speaks of the duration of the state.)

33. For surely it is one thing quietly to *confess* one's fear--and quite another to *give expression* to it unabashedly. The words can be the same, but the tone and the gestures different.

34. When it is said in a funeral oration "We mourn our...", this is surely supposed to be an expression of mourning; not to tell anything to those who are present. But in a different setting these words are an announcement. In a *prayer* at the grave they could also *in a way* be used to tell someone something. [*PI II*, ix, p. 189a]

35. We surely do not always say someone is *complaining* because he says he is in pain. So the words "I'm in pain" may be a cry of complaint, and may be something else. (Something similar holds for expressions of fear and other emotions.) [*PI II*, ix, p. 189d]

36. But if "I'm afraid" is not always like a cry of complaint, and yet sometimes is, then why should it *always* be a description of my state of mind?†1 [*PI II*, ix, p. 189e]

37. For how does the complaint "I'm in pain" differ from the mere announcement? By its intent, of course. And possibly that will also come out in the tone.

38. The contexts of a sentence are best portrayed in a play. Therefore the best example for a sentence with a particular meaning

is a quotation from a play. And whoever asks a person in a play what he's experiencing when he's speaking?

39. "I must tell you--I'm frightened."
"I must tell you--it makes me shiver."
And one can say this in a *smiling* tone of voice too.
And do you mean to tell me he doesn't feel it? How else does he *know* it?--But even if it is a piece of information, he doesn't read this off from within. For he couldn't cite his *sensations* as proof of his statement. *They* don't teach him this. [*PI II*, i, p. 174e]

40. For think of the sensations produced by gestures of shuddering: the words "it makes me shiver" are themselves such a gesture, and if I hear and feel them being expressed, that belongs among the rest of these sensations. Now why should the wordless shudder be the ground of the verbal one? [*PI II*, i, p. 174f]

41. We learn to use the word "think" *under particular circumstances*.
If the circumstances are different we don't know how to use it. But this does not mean that we have to be able to describe those circumstances. [a: cf. *Zettel* (Z) 114; b: cf. Z 115]

42. "If people differed strongly in their statements about colour they couldn't use our concept of colour."--If people differed strongly in their statements about colour then just because of this they wouldn't be using *our concept of colour*.

They wouldn't be playing our language-game: For just think how theirs and ours would have to be compared!

43. So, if I hear someone say "I am afraid", how can I find out whether this is the 'description of a state of mind' (or some such thing)? Should I ask him, and is it certain that he will understand the question?--But he could surely answer it. How? *This* way, for example: "No, I was just letting off steam", or "Yes, I want you to know how I feel".

But such a question will almost never be asked. Isn't this because the tone and the context necessarily give us the answer? For from these we will deduce whether he is making fun of his own fear, perhaps, or whether he is discovering it in himself, so to speak, or whether he is confessing it to us reluctantly, but for the sake of candour, or whether he is uttering it like a scream, etc.--And don't

the words, no matter how they are uttered, give me information about the same state of affairs, namely, his state of mind?

44. Does the sentence "Napoleon was crowned in the year 1804" really have a different meaning depending on whether I say it to somebody as a piece of information, or in a history test to show what I know, or etc., etc.? In order to understand it, the meanings of its words must be explained to me in the same way for each of these purposes. And if the meaning of the words and the way they're put together constitute the meaning of the sentence, then - - -.

45. But here is the problem: A cry, which cannot be called a description, which is more primitive than any description, for all that serves as a description of the inner state. [*PI* II, ix, p. 189b]

46. That someone can scream doesn't mean that he can tell somebody something in a conversation.

47. I hear the words "I am afraid". I ask: "In what connection did you say that? Was it a sigh from the bottom of your heart, was it a confession, was it self-observation,...?"

48. Does someone crying out "Help!" want to describe how he is feeling?

Nothing is further from his intentions than describing something.

49. But there are transitions from what we would not call a description to what we would.

50. The phrase "description of a state of mind" characterizes a certain *game*. And if I just hear the words "I am afraid" I might be able to *guess* which game is being played here (say on the basis of the tone), but I won't really know it until I am aware of the context.

51. For one or another of a class of features goes with what we call "describing". Observing, considering, remembering behaviour, a striving for accuracy, the ability to correct oneself, comparing.

A cry is not a description. But there are transitions. And the words "I am afraid" may approximate more, or less, to being a cry. They may come quite close to this and also be *far* removed from it. [b: *PI* II, ix, p. 189c]

52. If a sensitive ear shows me when I am playing this game that I have now *this*, now *that* experience of the word "switch"--doesn't it also show me that often I do not experience that word itself in the context of a whole sentence which I understand and in some sense experience? [Cf. *PI* II, xi, pp. 215h-216a]

53. "The meaning of the word stood before my soul."--Will we say that if the word appears in an unambiguous setting?

54. A kind of writing†1 in which the crossed-out word, the crossed-out sentence, is a sign.

Page 9

55. You assured me that you experienced the word as 'meant' in the particular way you just now uttered it: Then tell me also, with the same finely tuned sensitivity, whether in its proper context you 'mean it *that way*', *in that sense*. For it is clear that in another sense you mean it, intend it, and later on even explain it *this way*, and not *that*. [Last sentence: cf. *PI II*, xi, p. 216a]

Page 9

56. But the question now remains why, in connection with this *game* of meaning, we also speak of '*meaning* it'.--This is a different kind of question. It is part of the phenomenon of the game that in *this* situation we use the word "meaning".†2 [Cf. *PI II*, xi, p. 216b]

Page 9

57. Then is it a misunderstanding?

Now I am not using the word *for* something else; rather I am using it in a different situation. [Just as I am not using "know" to refer to two different things when I say "In my dream I knew". Cf. also: feeling of unreality.] In that case should I be taught the technique of its use in a different way?

Page 9

58. Suppose I hear one of Beethoven's works and I say "Beethoven!"--Does the word have a different meaning here than in the sentence "Beethoven was born in Bonn in 1770"? (The tone of the

Page Break 10

exclamation could be explained to someone who didn't understand it by saying: "Only Beethoven writes†1 like that".)

Page 10

59. Would it be more correct to say that yellow 'corresponds' to *e* then "*e* is yellow"? Isn't the point of the game precisely that we express ourselves by saying *e* is yellow?

Indeed, if someone were *inclined* to say that *e* 'corresponds' to yellow and not that it is yellow, wouldn't he be almost as different from the other as someone for whom vowels and colours are not connected? And similarly for the experience of meaning.†2

Page 10

60. Suppose I am learning a language and want to impress upon myself the double meaning of the word "bank", and so I alternately look at a picture of a river bank†3 and then a money bank, and in each case say "bank", or "That is a bank"--would the 'experience of meaning' then be taking place? Certainly not there, I'm inclined to say. But if the inflection of voice, for example, seems to me to determine whether I mean one thing or the other--then I would be experiencing meaning.

Page 10

61. It isn't as if we were obstinately referring to two things with the same word and then were asked: Why are you doing this, if *in reality* they are different?--The new use consists in applying the old expression in a new situation; it is not to designate something new.

Page 10

62. The experience of the 'word that hits the mark'. Is this the same as the experience of 'meaning'?

Page 10

63. "Why in a dream do we call *this* 'knowing'?"--We don't call anything 'knowing' in a dream; rather we say "In my dream I knew..."

Why do we call this "meaning" and "signifying" if it is not a question of meaning and signifying?--What do I call 'meaning' (or 'signifying') in this game: I say "By that word I just now meant..."

But what am I calling that?--An experience? And what experience?

For can I describe it otherwise than just by the expression: I 'mean' this word in *this way*?

Page Break 11

Page 11

64. Therefore I can't say that I'm simply giving the same name to two related things. (Otherwise the problem would never have arisen.)

Page 11

65. "Why are we talking about 'meaning' in relation to that game?"--What am I asking for? A reason, a cause?--Certainly not for a consideration which leads me to speak that way; nor for a justification; for such things

are not in question.

Page 11

66. Call it a dream!†1 [Cf. *PI* II, xi, p. 216b]

Page 11

67. But the question remains: why in the *game* of 'meaning' does a person use the same word?--Can he use a different one? Does he use the same word *for* something different? Could he give another explanation of it?

Page 11

68. Call it a dream. It does not change anything. [*PI* II, xi, p. 216b]

Page 11

69. "Schubert"--It's as if the name were an adjective.

Neither can one say: "Look at all the things that '*fit*'. For example, the name fits the bearer."†2

An addition, after all, would be an extension; and an extension is just what is *not* found here. For one doesn't say that something is a '*fit*' if *actually* it is no fit at all. As *if* one were merely expanding the concept. Rather we are dealing here more or less with an *illusion*, a mirage. We think we see something that isn't there. But this is true only *more or less*.--We know very well that the name "Schubert" does not stand in a relationship of fitting to its bearer and to Schubert's works; and yet we are under a compulsion to express ourselves in this way.†3 [Cf. *PI* II, xi, p. 215f]

Page 11

70. We see something according to the picture, the concept, of fitting.

To be sure, I can regard one thing as a variation of another. And in an extreme case what I see *as* a variation may no longer have any

Page Break 12

similarity at all to the thing of which I am seeing it as a variation.--To rephrase: First, *this* figure is a simple projection of *that* one. Then the lines of projection are curved a bit; but to me it's still a projection. Finally they are bent to the point of being unrecognizable, but I still see a projection. (Just as some continue to see an old man as the young one, the one who has changed completely as what he used to be.)

Maybe it is strange to bring into this context the case of a person's name. But a connection can be drawn. Namely this: a person's name is *seen* as a portrait.

Page 12

71. Suppose that I see a triangle as a square, by seeing it as the end of this kind of transformation:



--Then the kind of varying is part of the aspect that is seen. But this is just not the case when a name seems to us to be the portrait of its bearer.

Page 12

72. I say something (for example, "The name 'Schubert' really does fit Schubert perfectly")--it means nothing.†1

Page 12

73. In the sense in which we are using it, the sentence "The name... fits..." doesn't tell us anything about the name or its bearer. It is a pathological statement about the speaker.--One doesn't teach a child that this name fits the bearer.

Page 12

74. Someone waves (to me) with his hand. "What did you want?"--"I wanted you to come."

That is his intention when he waves.

The sign was the source of a movement. So wasn't it also the source of the explanation? Could this explanation itself *go*: "Waving my hand was the source of the explanation which I shall now give you: Come to me"?

Page 12

75. One cannot say here "It [the name] doesn't *fit* exactly", or "It doesn't seem to *fit* exactly".

It's not as if "fit" were not *exactly* the right word.

To be sure, we could use other words too; for example, "There is a kinship".

Page 12

76. "What is always associated is easily taken as akin." Is *that* the right expression? Not quite. But it is as if they were akin.

This is not the way it is: "I take them for kin even though they are not"--for all I have to do is to wake up, as it were, in order to know that they are not. But I see them pictured as akin.

Page Break 13

I use the word, the picture.

Of course, one can explain: Fitting together and association frequently go together; and thence the illusion (if one is to call it an illusion).

77. I imagine that a physiological explanation of this strange phenomenon has been found. Now we see how the illusion came about. For then what sometimes occurs in the brain is the same thing that occurs when.... Joyous excitement: Now we understand why everybody always said...! And when the explanation has been given, when the riddle has been solved†1--where does that leave us? It has only cleared up a question we weren't interested in, and we are left with the fact that we use that expression, that picture, or want to use it, when the normal occasion for its use is lacking.

78. But then the question remains why we also talk about the act of 'meaning' in that *game* of meaning a thing. This question doesn't belong here at all. We use the word here because it has *this* meaning. No other word, no other meaning, would do for us. The fact has to be accepted.†2

79. But is the word now being used in two senses? No. (Otherwise we would owe an explanation.) Does one teach its usage in two different ways?

80. But isn't an explanation of this strange phenomenon of interest to us, after all?

Think of other, related phenomena and what their explanation accomplishes. Yes, it is certainly interesting to understand *why*, while taking this walk, I am under the impression that the city must lie over *there*; even though a moment's reflection can convince me that it is not so. Now I shall assume that I know how the illusion came about: The similarities between this landscape and another led me to draw the wrong conclusions, etc.--But I hadn't explicitly drawn the wrong conclusion, and furthermore this doesn't explain why these similarities led me to draw this precipitous conclusion. The explanation leaves the oddity untouched. (The same holds for the phenomenon of seeing sounds as colours, etc.)

81. If someone answers the question "Will N. return?" time after time in the affirmative, this can be expressed by saying he is in a *state* of thinking it is so. But no one will say that the answer "N. will return" describes the state of the speaker.

82. If "I believe p" states that I am in a certain state, then so does the assertion " \vdash p".

For the presence of the words "I believe" can't do it, can at the most hint at it. [Cf. *PI* II, x, p. 191d]

83. Imagine a language in which "I believe that p" is expressed only by means of the tone of the assertion " \vdash p". They say, not "He believes" but "He is inclined to say..." and there exists also the hypothetical "Suppose I were inclined to say...", but not the expression "I am inclined to say...". [*PI* II, x, p. 191e]

84. After all there are anomalies in other cases. We say "Maybe it will rain", but not: "Supposing that maybe it will rain, ..."

85. Moore's Paradox wouldn't exist in that language; instead of it, there would be a verb that has no first person present. [*PI* II, x, p. 191e]

86. But this ought not to surprise us. Think of the fact that one can predict one's own future action by an expression of intention. [*PI* II, x, p. 191e]

87. Think of the expression "I say..."--for example, "I say it will rain today", which simply comes to the same thing as the assertion "It will... today". "He says it will..." means approximately "He believes it will...". "Suppose I say..." does *not* mean "Suppose it will... today". [*PI* II, x, p. 192f]

88. Different concepts touch here and coincide over a stretch. But you need not think that all lines are *circles*.



[*PI* II, x, p. 192g. No figure in *PI*]

Page 14

89. Just because someone sees something according to a certain interpretation, that doesn't mean that he experiences an interpretation.

Page Break 15

Page 15

90. Anyone who thinks knows how notes or pictures which would be meaningless to someone else and which one can't even explain to oneself, can stand for thoughts, or individual features of thoughts.†1 (The notation of a calculating prodigy.)

Page 15

91. "Did you mean *this* when you said the word?"--"No, I was thinking of something else when I said that."--Is that an experience? No. An experience would not be of the same interest. An experience might perhaps inform the psychologist about the *unconscious* intention.†2 [Cf. *PI* II, xi, p. 217d]

Page 15

92. That is: If I were to find out, for instance, that when he was uttering the word he saw this or that in his mind's eye, then it might be possible for me to infer something about a tendency in his subconscious mind--whatever was in his mind was not his intention when he was uttering the word, his thought accompanying the word.

Page 15

93. "This plant grows from a germ, and not that plant." Imagine that people really expressed themselves in that way in some language!

Page 15

94. But what is the germ?--The experience at the time of speaking. (Thus, for instance, an image--such as frequently exists.) But really, according to its nature, it isn't the germ at all. Nor does something become a germ because of the later development. What remains then, is that the image of the germ forces itself upon us. (Quite naturally so; for we want to see the kernel of the matter in the experience.)

Page 15

95. The question which must interest us is therefore: What is the reference to the moment of speaking for? What does it tell us?†3

Page 15

96. "I imagined you would think of him then." This wasn't contained in the image he had in his mind (for that couldn't be known exactly), nor was it because of the name which he repeated to himself (it could have been someone else's as well). It was the chain of interpretations, of explanations.

For when he says "At that point I was thinking of...", "By this I

Page Break 16

Page 16

meant...", he is *thereby* making the connection with that point of time.

(So he doesn't remember a mental picture, for instance, which he had in his mind and which now shows him that he thought of....)

Page 16

97. He doesn't read off what he was thinking of from the mental picture.

Page 16

98. It said something and at that point I had to think of N. When did N. occur to me? At what moment, during which of his words?--And even if I know which word--what happened to me when it was spoken?

The thoughts began with the word. That's where the train began. But what makes them into a train? The fact that I say so?

Page 16

99. "I noticed that when this word was said, you turned pensive."

Page 16

100. "As I heard that word he occurred to me." What is the practical significance of this point of time?--For I want to say; "*It seemed to me* that he occurred to me at that word"--and the subjective element of this statement makes no difference. The question still remains the same: "What consequences does such a report have?"

Page 16

101. "When this word was spoken I thought of him." How is this report interesting? What primitive reaction corresponds to such words?

Page 16

102. "À propos..."

"What made you suddenly think of him?"--"You said... and that reminded me of him."

Page 16

103. When do we say, I am writing to *this* person? How does this manifest itself? How do I know it myself?!--Am I writing to *him* while I'm writing?

Page 16

104. It would almost be strange to say: "I thought of him while I was writing to him."

Page 16

105. "We were just talking about *him*", about this man I am now pointing to. How did the conversation relate to him? Didn't I create the connection with these very words?

Page Break 17

Page 17

106. "I knew who you were talking about."--How could I know it? And what kind of mental state *was* the 'knowledge that the conversation was about *this* man'?

Page 17

107. "Who were you talking about?"--"About N."--"About my friend N."--"About the person in this photograph."--"About the person who is just coming through the door."

Page 17

108. If God looked into our minds he would not have been able to see there who we were speaking of. [PI II, xi, p. 217f]

Page 17

109. In philosophy one must distinguish between propositions that express our mental inclination, and those that *solve* the problem.

Page 17

110. The incurable illness is the rule, not the exception.

Page 17

111. In saying this you refer to the time of speaking. It makes a difference whether you refer to this time or that. (The explanation of a word does not refer to a point of time.)
What makes you want to say that? (Why is this question important?) [a, b: PI II, xi, p. 217h]

Page 17

112. "Why did you look at me at that word; were you thinking of...?"

So there is a reaction at a certain moment, and "I thought of..." explains the reaction. [Cf. PI II, xi, p. 217g]

Page 17

113. "At that word we both thought of him."

Let us assume that each of us said the same words to himself--and how can it mean MORE than that?

But wouldn't even those words be only a *germ*? They must surely belong to a language and to a context, in order really to be the expression of the thought of him. [PI II, xi, p. 217e]

Page 17

114. For sometimes a word actually gets uttered in the midst of a silent train of thought. And this could be reported. Just as in general one can report that at the time he was quietly thinking of this or that. Whatever interest there is in *this* report, there must also be in that one; and therefore also in the report that he thought of... when he heard the word....

Page 17

115. "Then I thought: I wonder whether he'll come--."

Page Break 18

Page 18

"You wore such a doubtful expression; what were you thinking?"--"I was thinking: I wonder whether he'll come--". ----"Did you then speak these words, or ones like them, to yourself?"--"No. Strangely enough I was thinking of the Piccolomini,†1 of the scene in which...".

Page 18

116. In important ways, speaking in one's imagination cannot be compared to speaking, but our language-games

with the two are similar. (Tennis with a ball and tennis without one.) In those games too some mental picture plays the role of a real one, which also can exist in *connection* with sentences and explanations.

Page 18

117. That is: Our language-game refers to a mental picture more or less in the same way as it does to a spoken sentence. For the latter too is only a sequence of sounds and by itself refers to nothing at all.

Page 18

118. Now the question arises: When a word occurs in a certain context, I can create a different context for it in my mind--but if I don't do that, if nothing out of the ordinary happens, then does my thinking run alongside my speech?

Page 18

119. Even if my thinking sometimes deviates from the path of speech, still it normally follows that path.

Page 18

120. If everything goes normally, no one thinks of the inner event which accompanies speech.

Page 18

121. Philosophy is not a description of language usage, and yet one can learn it by constantly attending to all the expressions of life in the language.

Page 18

122. Knowing, believing, hoping, fearing (among others) are such very diverse concepts that classifying them, or pigeonholing them, is useless to us. But we do want to recognize the differences and similarities among them.

Page 18

123. Compare: "When you spoke about N. I thought you meant..." and "When you spoke about N. I knew that you meant...".

Page Break 19

Page 19

Is a particular experience associated with the latter? Then why with the former?

Page 19

124. The expression: "... passed through my mind."

"When I was reading, the conversation we had yesterday passed through my mind." Does what I read also pass through my mind when I read attentively?

Page 19

125. "No, when I said 'bank' the river bank flashed through my mind."--Would I also say that the money bank had 'passed through my mind' if everything had happened normally?

Page 19

126. Suppose that someone were to tell us, right after everything he says, what went on in his mind when he was saying it. (It's a habit.) Would that interest us in every case?

Page 19

127. "When I said 'bank' naturally I meant the bank where you get money." Did an experience of meaning have to accompany the word? (Nonsense!)--Why does this have to be so if--against the grain of the context--I was thinking about the river bank?

Page 19

128. "I have already remembered three times today that I must write to him." Of what importance is it what happened then?!--On the other hand what is the importance, what the interest, of the statement itself?

It permits certain conclusions. [Cf. *PI* II, xi, pp. 217j-218a]

Page 19

129. "I hadn't forgotten about it completely; I remembered it three times today."--"Yes, I know: you flinched as I was speaking of...."--Light is shed on this state of mind, and it has certain consequences. Different ones from those resulting, for example, from this state of affairs: "It had *completely* slipped my mind; I didn't think about it any more."

Page 19

130. At that word I went in *this* direction. (It is as if one were supplying the tangent at this point on the curve.)

But that again is merely an image. (As when tennis without a ball is described in terms of tennis with a ball.)

Page 19

131. The language-game "I mean (or meant) *this*" (subsequent explanation of a word) is quite different from the language

Page Break 20

game: "I thought of... as I said it". The latter is akin to: "It reminded me of...". [PI II, xi, p. 217i]

Page 20

132. In these cases a characteristic reaction can occur *at the time of* meaning, remembering, or reminding.

Page 20

133. What is the primitive reaction with which the language-game begins, which then can be translated into words such as "When this word occurred I thought of..."?†1 How do people get to use these words? [Cf. PI II, xi, p. 218b]

Page 20

134. "You said the word as if something different had suddenly occurred to you as you were saying it." One doesn't learn this reaction.

The primitive reaction could also be a verbal reaction.

Page 20

135. Suppose I'm talking with someone about Dr N. In the middle of the conversation I say "When the name 'N' came up just now I thought of Dr N."--the person I'm talking to won't understand me.

If I had said "When I said 'N' just now I meant Dr N., who...", the response might have been: "Of course, who else could you have meant!"

If I had said "When the name 'N' came up, I could just see Dr N. in front of me", that might well have been beside the point.

Page 20

136. "At the mention of the word I thought of..."--If the person who said this were asked what was then going on inside him, and he couldn't answer *anything*--was his statement invalid?--He could have answered "I forgot it", and *he only thought* that he ever knew.

Page 20

137. Is "In using the sign I wanted to let you know..." comparable to: "When I opened my mouth just now, I wanted to say..."? That is: Is the former sentence therefore not so much a definition as the expression of a past intention?

Page 20

138. "Why did you look at me?"--"By this sign I wanted to give you to understand that you..." This does not express a symbolic convention (no agreement); rather, it expresses the purpose of my action. To be sure, I was able to use a sign which was agreed on for that purpose. [Cf. PI II, xi, p. 218c]

Page 20

139. "This number is the right continuation of this series." With these words I may bring it about that for the future someone calls

Page Break 21

such-and-such the "right continuation". What 'such-and-such' is I can only show in examples.--That is, I teach him to form a series (basic series) without using any expression of the law of the series; rather as a substratum of the use of algebraic rules, or what is like them.†1 [Z 300]

Page 21

140. Now, to be sure, in teaching someone the basic series, I can use the word "equal" which perhaps he already knows from other contexts, that is, with a different, though related, meaning. And it may be that he learns how to construct the basic series more easily if I tell him "You must continue to do that, always adding one", thus stating a rule; but here it doesn't (yet) function as a rule, and so far there is no algebra.

Page 21

141. If there were a verb meaning: to believe falsely, it would not have any first person present indicative. [PI II, x, p. 190g]

Page 21

142. "I believe he'll come, but he certainly won't come." If I say that to someone, it tells him that he won't come but that nevertheless I am thoroughly convinced of the opposite, and will act according to this belief. However, by the very fact that I am reporting to someone else that he won't come, I am not acting according to this belief.

Page 21

143. "I firmly believe he'll come, but he certainly won't come."

Why do we tell somebody that we believe something? In order to convince him of what we believe, or only to inform him of our behaviour with respect to the matter?

Page 21

144. Observe: "He won't come, but I shall pretend that I believe he will come." I could say this to somebody, but this pretence might really be the result of a pathological compulsion, so that it really wouldn't be pretence at all.

This could be put as follows: That's not the way it is, but I *have* to believe it.

145. I said that the sentence "I believe that's the way it is, and it isn't" can be true; that is, if I do falsely believe it; which is, after all, a possibility. But what makes the sentence true? How can someone else see that it is true? How does he know that I believe it? Not from my behaviour; for that is full of contradictions.

146. If I say: "Look! This figure is contained in this picture"--am I making a geometrical remark?--Isn't 'this picture' that of which *this* is an exact copy, that which could be described with these particular words? Would it therefore make sense to say that it *now* contains that figure or that it *had* contained it?--Thus the remark is timeless, and it can be called "geometrical".

147. What does this imply about perceiving such a state of affairs?

Suppose someone is looking at a picture puzzle and finds the figure that is hidden in it. But he imagines that the picture has changed, that the figure has now come into being. He might say, for example, "Now this figure is here".

Or, on the other hand, the picture could have changed, unknown to him, and he merely *believes* he has discovered something in it which has always been there.

148. "Actually you should point to your own visual impression when you say 'I see this', then you would really be pointing to what you see." A result of the crossing of different language-games. (Similar to "'This' is the true name.")

149. "Now I see that these faces aren't exactly alike." (Timeless sentence.) But that is what eyes are for, after all! Imagine that someone wanted to say: "Indeed, that is a perception via the sense of sight; but it doesn't describe my visual impressions." What would they be? Well, I looked from one face to the other, so that I could compare them, and in the process I received a great many visual impressions; or one visual impression which changed continuously, something that one might represent by means of a film. But couldn't we isolate just two among all these impressions, in order to simplify things, and wouldn't two visual impressions be enough in the extreme case? And couldn't these two represent what I had noticed, namely, the dissimilarity?

Isn't there just a completely different game here?

150. It's no accident that I'm using so many interrogative sentences in this book.

151. So should I say here that the visual *impression*, the sense datum, the visual object, is different? This concept doesn't seem quite right. If we were to imagine that we could see similarity or difference as something like a picture, then we might think of them as being *accentuated* in the picture; just as we can heavily trace over the outlines

of whatever is different in order to show someone where the differences between two pictures lie. But if someone sees what was traced over in the two pictures, he hasn't yet seen that dissimilarity.

You have to look at the game as a whole, and then you'll see the difference.

152. "I see that the two are similar" can be used temporally or timelessly depending upon how 'the two' are defined. But does that mean that I *see* something different each time? "I see" is always temporal, but "The two are similar" can be timeless.

153. But is it always clear, in everyday usage, whether the sentence is meant as temporal, or timeless?--Take two brothers; I meet them and then I say "Yes, I see that they resemble each other". Did I mean: these two men, M and N, now resemble each other? (Perhaps they didn't before, etc.)--Or did I mean: I notice that these two human appearances, which, for instance, a picture can capture, resemble each other?--If I had made the original utterance and then had been asked in which of these ways I had meant it, could I have answered unequivocally?

154. "You shouldn't draw his face" could mean: You shouldn't draw this person's face, no matter what it looks

like--or: You shouldn't draw these facial features which right now happen to be his. Each time something different is important. And the injunction has different consequences, depending on which way it is taken.

Page 23

155. Even if I say "There is a similarity between these two faces", several different things can matter to me. It could mean, for example: There is a similarity between *this* kind of face and *that* kind, where the two kinds are distinguished by describing them. It may be the faces of *those men* that interest me, or it may be these facial *forms*, wherever I encounter them.

The distinction I have in mind is, of course, that between the sense of: These two pieces have a similar shape--and: The circle, the ellipse, the parabola, and the hyperbola resemble each other.

Page 23

156. The difference is that between external and internal similarity.

Page Break 24

Page 24

157. Now if I say that two faces are similar--does it make sense to ask "Do you mean external or internal similarity"?

Page 24

158. "Does it interest you that you can detect a similarity in what seem to be quite different *shapes*?"

"Are you trying to say that these *shapes* have something in common--or that these *human beings* do?"--But where is the difference?--Are you interested in the *shapes*, or the *human beings*? If it's the shapes, then maybe you'll copy them exactly, study the similarity among the lines, and you'll completely forget the men. If there's a discussion about them it will be a geometrical one, about types of lines.

Page 24

159. Suppose I retrace the facial outlines in order to explain to someone how they're similar, and he says "Sure, these lines have a similarity, I see that; but that's not the way these faces look, ..."--then I could reply: "Perhaps you're right, but that's not what I'm interested in. I wanted to point out that *this* kind of shape and *that* kind, however different they may appear,..." Here what concerns me is a geometrical question.

But if I had answered: "You're right, I made a mistake"--I would have been concerned with the similarity of *these human beings*.

Page 24

160. "They're brother and sister, but they don't look alike at all."--"I can see a similarity between them." What am I interested in here?

Page 24

161. Suppose there were a law of aesthetics that said that faces in a painting have to be similar. Now I point to two people and say to someone "Use these as models for your picture; they are similar".

Page 24

162. The sentence is non-temporal if I cannot replace "They are similar" with "They are now similar".

But if I utter that sentence on a certain occasion, is it always clear whether I wanted to allow the substitution? Must I have thought about it?

Page 24

163. I can be interested in seeing similarities in lines even where apparently there are none. That is, in my analytical eye.

Page 24

164. "I see different things in a much more important sense than I do things that are the same."

Page Break 25

Page 25

165. A picture story. In one of the pictures there are ducks, in another rabbits; but one of the duck heads is drawn exactly like one of the rabbit heads. Someone looks at the pictures, but he doesn't notice this. When he describes them he describes this shape first as the one, then as the other, without any hesitation. Only after we have shown him that the shapes are identical is he amazed.

Page 25

166. So he saw both aspects, but not the change of aspect.

Page 25

167. Would he have drawn the head differently in each case if he had been copying the picture? Not so far as I know! So he saw them in exactly the same way both times.

Page 25

168. But did he have the same image both times?--So far as I understand this question--*no*.

169. In the change of aspect one becomes *conscious* of the aspect.

170. But was it correct to say "He saw both aspects, but not the change of aspect"? Shouldn't I have said "He interpreted the picture in two ways, but didn't see the change of aspect"?

At first the picture was like some sort of picture of a duck; and if he saw an aspect here, then really he saw one in every picture, and therefore also in every object. For have I examined every picture to see whether it can't be seen differently?--So I shall say: he didn't *see* the aspect; he interpreted the picture in such-and-such a way.

171. Experiencing an aspect expresses itself in *this* way: "Now it is ..."

172. What is the philosophical importance of this phenomenon? Is it really so much odder than everyday visual experiences? Does it cast an unexpected light on them?--In the description of it, (the) problems about the concept of seeing come to a head.

173. And here we can ask: If someone says "Now it's a duck--now it's a rabbit!"--what happened at the outset? At that point, after all, he had not yet experienced the change, and yet he is already saying "Now it is...". Well, precisely nothing '*happened*'; but he was already playing that game.

You would have to look for something to distinguish the visual experience that accompanies the words "Now it is a duck" from the

one that accompanies the words "That is a duck" (when a person knows nothing about aspects). And, of course, nothing is to be found.

For what should I say?--*When* does the experience I am interested in take place as he says "Now --, now --"? (Do we have *two* extraordinary experiences here? Or *three*?)

174. What is strange is really the surprise; the question "How is it possible!"

It might be expressed by: "The *same*--and *yet* not the same."

175. The paradox may manifest itself in laughter. But couldn't we also imagine someone who wouldn't laugh in this situation; to whom nothing seemed paradoxical.

And yet he too would experience the change of aspect. He would call the picture first *one thing*, then *another*: and that would be all.

176. And what is he doing? What he presents as an expression of his experience would otherwise be a perceptual report. (The strong similarity with the experience of meaning.)

177. Wherein lies the similarity between the seeing of an aspect and thinking? That this seeing does not have the consequences of perception; that it is similar in this way to imagining.

178. Imagine a sign language in which a duck's head were a certain message, and a rabbit's head another one. Someone using this code accidentally draws a duck's head so that it can also be seen as a rabbit's head. The recipient of the message gives it the wrong interpretation: this will come out in his actions.

But if he realizes that it can be seen *this* way and *that* he will not (also) behave differently, according to whichever aspect he happens just then to be seeing.

179. "Is it thinking? Is it seeing?"--Doesn't this really amount to "Is it *interpreting*? Is it seeing?" And interpreting is a kind of thinking; and often it brings about a sudden change of aspect.

Can I say that seeing aspects is *related* to interpreting?--My inclination was indeed to say "It is as if I *saw* an *interpretation*". Well, the expression of this seeing is related to the expression of interpreting.

180. Two uses of the report "I see..."--In one language-game the observer reports what he sees from his vantage point.--In the other, the same objects are scrutinized by several people; one of them says: "I see a similarity between them".

In the first language-game the report might have been, for example, "I see two people who resemble each other as father and son". This description is far less complete than one given, for example, by an exact drawing. But someone could give this more complete description and yet not notice the similarity.

And someone else could see this drawing and discover the resemblance in it.†1 [Cf. *PI* II, xi, p. 193a, b]

Page 27

181. There is a game of guessing thoughts. A variant of it would be: I say a sentence in a language which A understands and B doesn't. B is supposed to guess what I have said.

Another variant: I write down a sentence which the other person cannot see. He has to guess it; or guess what it is about. [Cf. *PI* II, xi, p. 223b, beginning]

Page 27

182. Guessing intention: On a piece of paper that the other person can't see I write that I shall raise my left arm at the stroke of the clock. The person is to guess what I am going to do at that time.

Page 27

183. "Only I can *know* what I shall do." But can't I make a mistake; and can't the other person predict it correctly?

But ordinarily the other person *doesn't* know it, and I often do.

Likewise the other person doesn't know to whom I am writing unless he sees it or finds it out from me; but I can say who it is.

Usually it is I who am asked about the motives of my actions and not someone else. Likewise I am asked whether I feel pain. This is part of the language-game.

Page 27

184. But would it be correct to say that my pain is hidden?

Page 27

185. Is the future, for example, hidden?

Page 27

186. "Nothing is so well hidden as future events. They *can't* be known. One can only know what is happening now."

Page Break 28

Page 28

187. To be sure, one cannot be deceived about one's immediate experience: but not because it is so certain. The language-game allows for senseless utterances even though not for 'false' ones.†1

Page 28

188. "One cannot know the future" is a grammatical remark about the concept 'to know'. It means something like: "That is not knowing." And now one could ask: Why should someone be tempted to draw *this* conceptual boundary? And the answer could be: Because of the uncertainty of predictions.

Page 28

189. "One can't know the future?--How about solar and lunar eclipses?"--"One can't really *know* them either."--"Know?--Like *what*, for example?" [Cf. *PI* II, xi, p. 223d]

Page 28

190. If a lion could talk we could not understand him.†2 [*PI* II, xi, p. 223h]

Page 28

191. Even if someone were to express everything that is 'within him', we wouldn't necessarily understand him.

Page 28

192. So he gets angry, when we see no reason for it; what excites us leaves him unmoved.--Is the essential difference that we can't foresee his reactions? Couldn't it be that after some experience we might know them, but still not be able to follow him?

Page 28

193. He behaves like a man in whom complicated thought processes are taking place; and if only I understand them I would understand him.--Let us *imagine* this case; and now he is reciting his thoughts to himself, and in a certain sense I understand his actions. That is, I see the trains of thought and I know how they lead to his actions.

Page 28

194. In this way he would cease being a riddle to me.

Page 28

195. Think of how puzzling a dream is. Such a riddle doesn't *have* to have a solution. It intrigues us. It is *as if* there were a riddle here. This could be a primitive reaction.

Page 28

196. It is as if there were a riddle here; but it doesn't have to be a riddle.

("All forms are like and none the same. And so the chorus points to a hidden law.")

197. I don't know what is going on inside him. I couldn't flesh out his behaviour with thoughts.

198. He is incomprehensible to me means that I cannot relate to him as to others.

199. If someone is suspicious of a mathematical result he will suspect the *arithmetic*. But isn't that just a method? If someone is suspicious of someone's direct expression of experience and doesn't think that he is lying, he will say that he doesn't know what the other person is saying, that he is dreaming or not in his right mind.

200. But how do I know what I would do *if...*? If I stepped out into the street and found everything completely different from what I was used to, maybe I would just go ahead and join in. So I would behave quite differently than ever before.

And yet there is something important about my remark.†1

201. Suppose we were to meet people who all had the same facial features: we should not know where we were within them. [C&V, p. 75]

202. A people: with a ruling class whose members all look alike (except for sexual characteristics), and with an oppressed class whose shapes and facial features vary as ours do.

203. A tribe unfamiliar with the concept of simulated pain. They pity anyone who indicates that he is feeling pain. They are unfamiliar with the suspicious attitude toward expressions of pain. A traveller coming from our culture to theirs frequently thinks that a complaint is exaggerated, indeed, that its only purpose is to generate pity; the natives don't seem to think that way. (In their language they have an expression corresponding more or less to our: "to feel pain".) A missionary teaches the people our language; in the process he also educates them and under his tutelage they learn to distinguish between a genuine and a pretended expression of pain. For he mistrusts many an expression of pain and suppresses it, and teaches the people to be suspicious.--They learn our expression: "to feel pain", and also "to simulate pain", and the question is: were they

taught a new concept of pain? Certainly I won't say that they only now know what pain is. For that would mean that they had never felt pain previously.†1

204. Had those people overlooked something, and did the teacher bring something to their attention?

205. And how could they remain unaware of the difference if sometimes they would complain when they were in pain, and sometimes when they were not? Am I to say that they always thought it was the same thing?--Certainly not. Or am I to say that they didn't notice any difference?--But why not say: the difference wasn't important to them?†2

206. "If a concept refers to a certain pattern of life then it has to contain a degree of indefiniteness." I am thinking of something like this: On a strip of paper we have a continuous and regular pattern of bands. This pattern of bands forms the background for an irregular drawing or painting, which we describe in relation to the pattern, since this relation is what matters to us. If the pattern were to run: a b c a b c a b c etc., I would have a special concept, for example, for something red that is on a c, and something green that appears on the following b.

Now once anomalies occur in the pattern I will be in doubt as to which judgment ought to be made. But couldn't my instruction have provided for this? Or *do I simply assume* that in being instructed in the use of the concept, that particular pattern was just taken for granted, but was never itself described?†3

207. If colours were to play a different role in the human world than they now do, what consequences would this have for colour concepts? This is actually a question of natural science, and I don't want to ask such a question. Rather, this: What consequences would seem plausible to us? What consequences would not surprise us?†1

208. If colours were to play a different role in the human world than they now do, what sort of colour concepts--different from ours wouldn't seem odd? Consider various cases.

The question hasn't yet been phrased properly; but what is its purpose?--

209. It is very hard to imagine concepts other than our own because we never become aware of certain very general facts of nature. It doesn't occur to us to imagine them differently from what they are. But if we do then even concepts which are different from the ones we're used to no longer seem unnatural to us.

210. Our concept of pure future "It will happen"--as opposed to "It's meant to happen" and "It is to happen". Must all peoples have this concept, which perceives time spatially, as it were?

211. If a pattern of life is the basis for the use of a word then the word must contain some amount of indefiniteness. The pattern of life, after all, is not one of exact regularity.

212. Imagine someone who counts only on his fingers, for whom five is a hand and ten the whole person, and who then goes on to count people on his fingers, etc. For him the decimal system will not be an arbitrary number system. For him it is not a method of counting, but counting.

213. Six pure colours. Does it have to appear to us this way?--Brown is not one of them.

But what does that tell us anyway? Where do we use such statements? When we describe things by their colours?--Indeed; when we do this, for example, in a general way.

"Brown is not one of them" can, after all, express the instinctive rejection of a colour combination.

214. "Light is white. Colours are already a shadow."--But is all 'light' really white? Doesn't the lamp give off light?--Where then

does the original proposition, which still sounds so evident, come from? (And why does it sound evident?)--We always call what is lighter white. If one of two colours is the lighter, then only it can be the white one. And lightness and light are equated here.

215. We have a concept of colour blending which supersedes all physical methods of blending colours. So that we can therefore say of such a method: it comes closest to effecting the 'pure' blending of colours, for example.

216. Thus we judge whether according to our concept the two colours a and b really *should* produce the colour c.

217. How did we arrive at this concept? That's really irrelevant.

218. "Several shadows together result in light."--This idea could already look like a fiendish perversion of truth.

219. Could we also perceive all colours as mixtures of white and black?--Possibly so, if under certain conditions, for example, white and black pigments produced red, green, etc. Maybe we would say: "Light brings out the red in black." (The colour is thus thought of as hidden in black.)

220. Red and green the same. I am imagining there being only *one* shade of red and green. In nature they always blend into each other (as certain leaves do in autumn). They are everywhere found together, one being a variation of the other. The distinction between them is no greater than the one between lighter and darker.

But don't the people see the difference?! Of course they do. But they have a word, say, "leaf-colour", which is fairly analogous to our colour names, and means red *or* green; and they have two modifiers, "sharp" and "blunt", more or less analogous to our "light" and "dark", which separate red from green. And now the question is: which of their concepts is closer to one of our colour concepts? Their concept 'leaf-colour', or their concept 'sharp leafcolour'

(that is, red), for instance?

(If they are discussing colouring or painting an object, they might say that they want it leaf-coloured. If they are asked whether it should be sharp or blunt they might answer that they don't care.) Or

Page Break 33

would these people then be colour blind? Well, if we teach them our language they turn out to be normal.

Page 33

221. It's just that the difference between red and green isn't as *important* to them as it is to us.

Page 33

222. If we present them with a greater variety of colours then maybe they will experience our system as the only natural one, that is, take it up and drop the other one, with no difficulty. But then again, maybe they won't.

Page 33

223. A type of painting, in which the illuminated side of figures is always painted green, the shadows always red.

Page 33

224. Could we imagine that people might have a concept of pretence that doesn't coincide with ours?--But would it then be the concept of pretence?--Well, it could be a concept related to ours.

Page 33

225. But aren't some of the traits of (such) a concept more essential, others less so? That is: If one changes *this* trait it will still be called "pretence"--but if *this* one is changed that word will no longer be used. And here *naming* means an attitude.

Page 33

226. People whose faces immediately give away their feelings to others hide their faces when they want to dissemble.

Page 33

227. These people say, not that one cannot look within, into the heart, but rather that one can't read the features when they are veiled.

Page 33

228. "One can't look into his heart." The question is: Can *he*? (*That* fixes the concept.)

Page 33

229. "One can't look into a person's heart." The real underlying assumption is that he can do this himself.--Is it experience that teaches us this?

I am inclined to say--yes and no.

Page 33

230. And there must be a reason for that.

Page 33

231. "He can tell me things about himself that I wouldn't otherwise know."

Page Break 34

Page 34

232. This much is certain: He can predict some of his bodily movements that I can't. And if I do predict his actions I do so in a different way.

Page 34

233. And is *that* an empirical fact? Or: *which one* am I talking about here?

For example, I can't move his arm voluntarily, the way I can mine. But what this means isn't all that easy to explain.

Page 34

234. I cannot know what he's planning in his heart. But suppose he always wrote out his plans; of what importance would they be? If, for example, he never acted according to them.

Page 34

235. Perhaps someone will say: Well, then they really aren't plans. But then neither would they be plans if they were *inside* him, and looking into him would do us no good.

Page 34

236. "Can't you see, he has pain!"--"Pain, *over there*? How come?"

He wouldn't understand what it means for another person to *have* pain.

Page 34

237. What if someone had been taught as a child that plants feel pain; later on in life, however, he no longer believes this.--How would this transition take place?

He casts off the idea like a garment that no longer fits.

Page 34

238. How would a person act who doesn't 'believe' that someone else feels pain? We can imagine how. He would treat him as something lifeless, or as many treat those animals that least resemble humans. (Jellyfish, for instance.)

Page 34

239. We all know the doctor's question "Is he in pain"; and the uncertainty as to whether a person under anaesthesia feels pain when he groans; but the philosophical question whether someone else is in pain is completely different; it is not doubt about each individual in a particular case. [The point of this sentence has not yet emerged.]†1

Page Break 35

Page 35

240. Do we encounter this doubt in everyday life? No. But maybe something which is remotely related: indifference toward other people's expressions of pain.

Page 35

241. Aren't the fictitious cases I am trying to deal with like mathematical problems? (And how would you solve *this* equation? And how this one?)

Page 35

242. The belief that this or that person isn't in pain because he isn't expressing it--or because he is only pretending--or because he is under anaesthetics--has different *grounds* than the belief that an amoeba feels no pain. These grounds are also different from those of that imaginary inhuman brute who regards expressions of pain in his environment as phenomena of lifeless objects.

But would this brute really say he *believes* they feel no pain?--Possibly. But would he mean the same thing as the doctor, for instance, who reassures us as to a patient's condition? The utterance--however he may have learned it--is used by him in a different context; even if some of its consequences are similar.

Page 35

243. "The *uncertainty* as to whether another person is in pain"--is it based on the fact that he is he and I am I? (But just ask yourself: "Can he know it? He doesn't have any object for comparison.") No, *here* I'm deceived by a picture. The uncertainty is a matter of the particular case, and the concept vacillates from one case to another. But that is our game--we play it with an *elastic* tool.

Page 35

244. Couldn't there be people who have never had occasion to feel this uncertainty?

Page 35

245. They would say: "Should I be uncertain because he is he and I am I? What in the world do you mean?"

Page 35

246. And could people play it with a rigid concept?--Then it would be different from ours in a strange way. For in the flux of life, where all our concepts are elastic, we couldn't reconcile ourselves to a rigid concept.

Page 35

247. Indeed, mustn't any concept simply of behaviour be formulated imprecisely if it is more or less to serve the game with such concepts?

Page Break 36

Page 36

248. After all, there could be someone who had serious, hopeless doubts about others. But how would he act? (Like a lunatic.) He would say, for example: At times I feel that another person and I are the same and at times I don't. Correspondingly, at times he would show pity, at other times he would show none, and sometimes doubt.

Page 36

249. The behaviour of humans cannot be foreseen, cannot be calculated. Let's assume it could be, that I have made the calculation and now I observe their behaviour (like movements of complicated machines).

If that happened--would it be possible to observe them sympathetically? Would it be impossible to say "No one can know what's going on inside them"?

If, for instance, someone says to himself "That's the way humans are. I am exactly like that."

Then he might look at his *calculation* in a different light.

Page 36

250. Why in the world *do* we play this game!--But what are we after here? The game's surroundings, not its causes.

Page 36

251. "Where I am certain, he is uncertain." What if that also happened with a calculation --.

Page 36

252. "Couldn't he have been pretending?"--But couldn't he just be *imagining* that he is pretending? (Isn't this conceivable? And conceivability is what matters to us here, not probability.)

Dissimulation is *nothing* but a particular case; we can regard behaviour as dissimulation only under particular circumstances.†1

Page 36

253. The concept 'dissimulation' has to do with the cases of dissimulation; therefore with very specific occurrences and specific situations in human life. And here I mean external occurrences, not inner ones, etc.

Therefore it isn't possible for all behaviour, under all circumstances, to be dissimulation.

Page 36

254. But isn't the concept such that for any behaviour, etc., one can imagine (construct) a larger context in which even this behaviour

Page Break 37

would be dissimulating behaviour? Isn't this, for example, the basis for the problem of any detective story?

Page 37

255. One could also say: The concept of dissimulation has to do with a *practical* problem. And the blurred outlines of the concept don't change anything about that.

Page 37

256. Merely recognizing the philosophical problem as a logical one is progress. The proper attitude and the method accompany it.

Page 37

257. But what does this mean: "All behaviour theoretically could be dissimulation."

Page 37

258. It must surely mean: the *concept* of dissimulation allows for it.

Page 37

259. And *that* means: If I were to find out this and that, and this in addition, then I might say that it is (was) dissimulation.

(Euclidean geometry.)

But where is it written that we would say that; or from what do I deduce it?

'Insofar as this concept has been *determined*, it allows for *that* too.'

Page 37

260. But now we're making a false picture of our concept.

Page 37

261. The concept 'dissimulation' serves practical aims.

Page 37

262. -- -- -- Therefore not all behaviour can be dissimulation under all circumstances.†1

(Occasion, motive, etc., are part of 'dissimulation'.)

Page 37

263. A play, for example, shows what instances of dissimulation look like.

Page 37

264. Of course, one could imagine variations of the typical manifestations of dissimulation.

The plays of people who differ from us in this way would then take a different course from ours, and we wouldn't understand them at all.

What would be completely unmotivated to us would seem natural to them.

Page Break 38

Page 38

265. (For example, the way Orestes identifies himself to the king, by pointing to his sword, etc., might seem utterly absurd to some people.)

Page 38

266. A play by these people would be incomprehensible to us. (Indeed, is Greek tragedy comprehensible to us?) And what is the meaning of 'to understand' here?

Page 38

267. A sharper concept would not be the same concept. That is: the sharper concept wouldn't have the *value* for us

that the blurred one does. Precisely because we would not understand people who act with total certainty when we are in doubt and uncertain.

Page 38

268. Couldn't someone make up stories containing dissimulation in order to show that he knows what 'dissimulation' is? In order to develop the concept of dissimulation he invents more and more complicated stories. For example, what looks like a confession is merely further dissimulation; what looks like dissimulation is merely a front that hides the real dissimulation; etc., etc., etc.

Thus the concept is laid down in a kind of story.

Page 38

269. And the stories are constructed according to the principle that *everything* can be dissimulation.

Of course, part of all this is that in each story something is characterized as the foundation of truth. And how can the foundation of truth be characterized as such? Perhaps in the form of monologues. These must not be audible, otherwise they might be part of the dissimulation.--But couldn't someone conduct monologues in thought merely because they give him a certain appearance which he will then use to practise deception?--So the *intention* is the foundation? And how can it come out in the story?

Page 38

270. The concept of deception can be used for practical problems. For example: If someone is hatching evil plots, and he brings forth nothing but good and glorious deeds until he finally commits the evil one, then that will be deception only in the 'theoretical' sense; for it no longer resembles deception, and the conclusions one would normally draw from evil plots are incorrect here.

Page 38

271. And what have I accomplished with all of this?

In explaining the concept I have substituted the use for the picture.

Page Break 39

Page 39

272. "The word W. has two meanings" means: it can be used in two different ways. What does this sentence tell us? In what circumstances it is used?

Someone knows only *one* meaning for the word "bank"; I tell him: it has another one. (Namely:...)

Someone is already totally conversant with every use of the word, but suddenly he stops short, confused, and I explain to him: "The word has two uses:..."

Page 39

273. There are many uncertainties with this concept of meaning.

Page 39

274. One doesn't say, for instance that "walk" and "walks" have different meanings.

They mean exactly the same thing, we would tell someone; namely, *this*--and then we would demonstrate walking to him.

Page 39

275. You visit a tribe; they have a language; in this language you hear a word (a sound)--does it have *one* meaning, or several? How will you find out, how will you decide?

Page 39

276. Sometimes, however, the decision will be quite easy and clear. [But always?]

Page 39

277. "I'm not yielding a hair's breadth."

"He doesn't have a hair on his head." Does "hair" mean the same thing in both sentences? And does "a bit" mean a little bite?--"In the one case one is still aware of the old meaning, but not in the other." And this sentence doesn't refer to any conscious state one is in when one utters the word, but rather to an explanation one would perhaps give, or not give, if... In other words, it refers to connections that one would or would not make.

Page 39

278. What is the correct German translation of an English play on words? Maybe a completely different play on words.

Page 39

279. And what do you want to do with the decision that the word has only one, or more than one, meaning?

After all, you can learn how to use it without deciding that (without thinking about that).

Page 39

280. If you say that it has two meanings then you have to use an explanation to distinguish between them. (There can be various reasons for doing that.)

Page Break 40

Page 40

281. But the distinction may or may not be immediately obvious.

Page 40

282. The distinction may be drawn when you first learn how to speak, or maybe not until someone investigates the grammar of the language.

Page 40

283. (You must start here with the living language.)

Page 40

284. The distinction between various uses is made for various reasons.

Page 40

285. I look at the language and say "Different words are used quite differently".

But then I also say: "These have similar uses." Indeed: "These words (here) are used in the same way." And furthermore: "This word has two completely different uses." But also: "It is used in two different, but similar, ways."--And so far I am describing what I notice. (That is, as yet there is no problem here.) (So far, I am still completely naive.)

Here every meaning always has an explanation corresponding to it. And the explanations can be of entirely different kinds, and then again can in various ways be quite similar.

[An explanation of "go" and "gone".]

The differences can be more primitive, and less so.

Page 40

286. You enter new territory when you observe *several* languages and compare them with each other.

Page 40

287. The explanation of how some words are used will seem simple, lapidary, and basic to us; that of others: artificial, arbitrary, pointless.

Page 40

288. "We *need* a word to designate this object, this tool; but why do we need a word to refer to this on Mondays, that on Tuesdays, etc?" Does this word have *one* meaning or seven?

Page 40

289. Not every *use*, you want to say, is a meaning.

Page 40

290. Does this word have *one* function in our lives or does it have seven?

Page Break 41

Page 41

A function: we have certain models for this. And whatever resembles them is given this name. (A blurred concept.)

Page 41

291. Meaning, function, purpose, usefulness--interconnected concepts.

Page 41

292. Imagine the hypothesis: men never remember their dreams exactly, they forget the ideas in their dreams as soon as they wake up and remember only the pictures that accompany the dreams. The plot is lost and only the illustrations remain.

Page 41

293. Suppose we were to replace every tenth word in a story with the word "table".--And now suppose that there were a word in some language which was used in the same way as the word "table" in this story.

How could we describe the use of such a vagrant word?

Or what would it mean: "To teach someone the use of the word"?

Page 41

294. What am I after? The fact that the description of the use of a word is the description of a system, or of systems.--But I don't have a definition for what a system is.

Page 41

295. I encounter people who use a vagrant word in their language.

Page 41

296. If they had only vagrant words--then it simply wouldn't be a language.

Page 41

297. Here I'm thinking of a person who quite naively (without the ulterior motives of a philosopher) looks at the varieties of word usage and describes them to himself.

For example, he could classify the word which has a different meaning every day of the week as a normal noun, and the question "Does this word have one or several functions?" wouldn't occur to him.

Page 41

298. The question "Do 'non' and 'ne' have the same meaning?" never occurs to him.†1

Page Break 42

Page 42

299. But now he also compares his language with the primitive language which a person learns when he is a foreigner encountering people who don't understand him. For such a person learns individual important words through various kinds of explanatory gestures. Each word has its own showing or demonstration (a scene).--And, of course, the meaning of negation is also demonstrated. (Whether through the command "Don't do that!", or through a statement.)

Page 42

300. In this language the exact endings of the words won't be important. (Or: this language has no inflections.)

The demonstrations distinguish between the use of one word and that of another, but they don't distinguish between "go" and "goes", for example.

Page 42

301. And now we could introduce into our description of language a concept of 'meaning' such that two words would have the same meaning if they were explained by the same demonstration in that primitive language.

Page 42

302. So one can ask: If a foreigner visits people who say "non" and "ne", at what point will he be taught the difference?

Certainly not at the beginning; he will learn a negation which doesn't differentiate between the two.

Page 42

303. Suppose I were to say that 'meaning' is the primitive function of a word--would that be right?

Page 42

304. And, of course, this concept is extremely vague.

But do the negation in a report and the prohibition in a command ("Don't do that!") have the same primitive function?--What is called the same function and what is not will depend on human nature. Just as, of course, what is necessary†1 and what isn't.

Page 42

305. The words "the rose is red" are meaningless if the word "is" has the meaning "is identical with".--Does this mean: If you say this sentence and *mean* the "is" as the sign of identity the sense disintegrates? [PI II, ii, p. 175c]

Page Break 43

Page 43

306. We take a sentence and tell someone the meaning of each of its words; this tells him how to apply them and so how to apply the sentence too. If we had chosen a senseless sequence of words instead of the sentence, he would not learn how to use the *sequence*. And if we explain the word "is" as the sign of identity, then he does not learn how to use the word sequence "the rose is red". [PI II, ii, p. 175d]

Page 43

307. And yet it is true that the sense of that sentence will seem to disintegrate before the mind of anyone who thinks "identical with" whenever the word "is" is spoken. Like someone who thinks of hail whenever he hears the salutation "Hail!"--One might tell someone: if you want to pronounce the salutation "Hail!" expressively, you had better not think of hailstones as you say it!†1 [PI II, ii, p. 175d]

Page 43

308. What makes my image of him into an image of *him*?

When I say "I'm imagining him now as he...", then nothing is being designated here as his portrait.

But can't I discover that I pictured him quite wrongly?

Isn't my question like *this*: "What makes this sentence a sentence that has to do with *him*"?

"The fact that we were speaking about him."--"And what makes our conversation a conversation about *him*?"--Certain transitions we made or would make. [a: PI II, iii, p. 177a]

Page 43

309. What makes this picture *his* portrait?--It is designated as such in the catalogue.

Page 43

310. Suppose that instead of imagining something, I were to make sketches on a piece of paper. So I talk about N. and in the process my pencil is sketching a figure on the paper. Now someone can ask me "Does that represent N.?" And it might represent him, whether it is like him or not.

Is it correct to say: That's the way it is with one's imagination? Certainly; insofar as one can sometimes draw what one has imagined.

Page Break 44

Page 44

311. The question "What makes *this* into an image of him?" doesn't usually arise when I am imagining something. And if I draw what I imagined and am then asked "What makes this picture into *his* picture?", I could answer: "My imagination".

Page 44

312. "What makes the remark I just made into a remark about him?"

Page 44

313. What can be said to that?

Nothing inherent in or simultaneous with it. If you want to know whom he meant, ask him!

Page 44

314. "What makes my mental image of him...?" Is there anything here I could investigate to see whether it was my mental image of him?

Page 44

315. And if I say "I picture him quite vividly as he... ", then the same question applies to this sentence and to the mental picture.

Page 44

316. On the one hand, a face could come before my mind, and I could even be able to draw it without my knowledge whose it is or where I have seen it. [Cf. *PI* II, iii, p. 177a]

Page 44

317. What makes my image of him into an image of *him*?

Not its looking like him.

The same question applies to the expression "I see him now vividly before me" as to the image. What makes my utterance into an utterance about *him*? Nothing in it or simultaneous with it ('behind it'). If you want to know whom he meant, ask him! [*PI* II, iii, p. 177a]

Page 44

318. Suppose, however, that someone were to draw while he had an image or instead of having it, though it were only with his finger in the air. (This might be called "motor imagery".) He could be asked: "Whom does that represent?" And his answer would be decisive. It would tell us of his intention. [*PI* II, iii, p. 177b]

Page 44

319. The line I drew was like a description.

Page 44

320. We have to remind ourselves that a face with a soulful

Page Break 45

expression can be *painted* to make us believe that colours and forms by themselves affect us like this.

Page 45

321. "I believe that he is suffering."--Do I also *believe* that he isn't an automaton?

It would go against the grain to use the word in both connections.

(Or is it like this: "I believe that he is suffering; but am I certain that he is not an automaton."? Nonsense!) (That would be philosophers' nonsense.) [*PI* II, iv, p. 178a]

Page 45

322. Suppose I say of a friend "He isn't an automaton".--What information would be conveyed by this, and to whom would it be information? To a *human being* who sees him in ordinary circumstances? What information *could* it give him?! (At the very most that this man always behaves like a human being and not occasionally like a machine.) [*PI* II, iv, p. 178b]

Page 45

323. "I believe that he is not an automaton", just like that, so far makes no sense. [*PI* II, iv, p. 178c]

Page 45

324. My attitude towards him is an attitude towards a soul. I am not of the opinion that he has a soul. [PI II, iv, p. 178d]

Page 45

325. Now a picture is strongly suggested to us, the picture of something incorporeal which enlivens the face (like quivering air). We have to remind ourselves that a face with a soulful expression can be painted to make us believe that colours and forms by themselves can affect us this way.†1

Page 45

326. The concept 'meaning' will serve to distinguish those linguistic formations that might be called capricious from those that are essential, inherent in the very purpose of language.

Page 45

327. The concept 'meaning' will introduce a new point of view into the description of word-usage.

Page 45

328. Example: A verb meaning *to write* in the first person, *to love* in the second, and *to eat* in the third.

Page Break 46

Page 46

329. Human nature determines what is capricious.

Page 46

330. But is it the nature of someone who already knows a language or of someone who doesn't yet know one (for instance, the nature of a one-year-old)?

Page 46

331. Is it, or is it not capricious that a word means something different every day of the week, or means something different in the first and second persons?†1

Page 46

332. 'Meaning' is a primitive concept. The form: "The word means *this*" belongs to it; that is, the explanation of a meaning by pointing. This works well in certain circumstances and with certain words. But as soon as the concept is expanded to include other words difficulties arise.

Page 46

333. The definition of a word is not an analysis of what goes on inside me (or what should go on) when I utter it.

Page 46

334. "Every two metres there are two soldiers."

Page 46

"He went into a bank on a bank."

Page 46

335. "I want to replace this word in our language with two words; I'll explain the one *like this*: ..., the other *like this*: ..." I also could have said: "This word in our language has two meanings: ..." Here one couldn't ask: "But are those really two meanings?"--But one could--if one meant by it: "Isn't this distinction completely arbitrary, utterly pointless?"

"Why do you distinguish between them, what's the point of this distinction?"

Page 46

336. "I don't see the purpose of it." But what does the explanation of a purpose look like? I can't give a general answer to this question.

Page 46

337. You are posing problems to yourself and then solving them; like a mathematician.

Page 46

The problem: non and ne.

Page 46

338. A person naively describing the use of words might also describe the use of "non" and "ne", and he'll be able to remark that they are almost the same.--But that's not all: can't he say that the two

Page Break 47

words are used differently only in very specialized language-games, and that otherwise they are used the same way?

Page 47

339. Mustn't he be able to say that in a certain language-game one word can be replaced by another?

340. If the language-game, the activity, for instance, building a house (as in No 2), *fixes* the use of a word, then the concept of use is flexible, and varies along with the concept of activity. But that is in the *essence* of language.

341. Let us imagine *this* use of "non" and "ne": both words are used like our "not"; the same event causes now the one to be used, then the other, and in this way they are just like synonyms; a distinction is made only in the rare case of double negation.

Thus I would be tempted to distinguish between the '*entire*' use of a word and a part of its use. Indeed the part of its use will seem more important here than the '*whole*'.

342. So I say: "The use is the same here and here and here. In all of these cases one can substitute one word for the other." But what does that really mean?

343. Does the person who describes things naively know the concept of '*being able* to substitute one word for another'?--Certainly he knows the concept of the mixed use of two words.

344. Or what about this: A traveller visits the country where "non" and "ne" are used and he tries to translate this language into his own. He won't have any reason to use different words to translate each of these into his language--until he happens upon a case of double negation (then he *might* find an equivalent word in his language).

345. For the traveller could say: "As far as I can tell they're used in the same way."

346. "In all of these cases 'ne' and 'non' have exactly the same meaning." This could be said, for example, if in these cases the people themselves *treat* the words as synonyms. (And we know what

that looks like.)--But possibly the tribe doesn't treat them as synonyms, doesn't '*mix*' them, and they might still be synonyms for us.

347. The greatest difficulty in these investigations is to find a way of representing vagueness.

348. One can speak of the function of a word in a sentence, in a language-game, and in language. But in each of these cases "function" means *technique*. Thus it refers to a *general* way of explaining and of training.

349. Whoever teaches someone a negation sign trains him in a certain way. (Double negation need not even appear in training.) But then at some point he can use double negation or hear it, and comprehend it this or that way. His comprehension doesn't have to be related to his previous training, even though it is conceivable that it might be. But am I to say that his training taught him the meaning of double negation? I don't have to say that. And even if the training has taught me to use two different words interchangeably to express negation, it certainly hasn't taught me how to discriminate between them when it comes to double negation.

I certainly didn't learn this distinction by being trained. But what I did learn by being trained was a meaning, and *the same one*.

350. Within a kind of training one can distinguish (further) kinds of training. And thus one can distinguish various uses within word-usage.

351. Then psychology treats of behaviour, not of the mind?

What do psychologists record?- What do they observe? Isn't it the behaviour of human beings, in particular, their utterances? But these are not about their behaviour. [*PI* II, v, p. 179b]

352. A doctor asks "How is he feeling?" The nurse says "He is groaning". *One* report on his behaviour. But need any question arise as to whether the groaning is genuine? Can't it be as if this question didn't exist at all? Can't the conclusion be drawn: "If he is groaning we must give him more pain-killer"? But in the context of these thoughts can't the report about behaviour be *used as* a report about a

person's mental state? Can't it do this job and isn't the job the main thing?†1 [*PI II*, v, p. 179d]

Page 49

353. "But then they make a tacit presupposition." Then the technique of our word use is always a tacit presupposition. [Cf. *PI II*, v, p. 179e]

Page 49

354. "We're always making presuppositions; if they aren't correct then, of course, everything is different." Do we say this, for example, when we ask someone to go shopping? Are we presupposing that he is human, and that the store is not a *Fata Morgana*? Presuppositions come to an end.

Page 49

355. But although it might not be a 'presupposition' in this case might it be one in a different case? Doesn't a presupposition imply a *doubt*? And doubt may be entirely lacking; or it may be present, from the smallest to the greatest degree.†2 [Cf. *PI II*, v, p. 180b]

Page 49

356. Suppose somebody were to say "I'm shivering with fright, I'm always shivering with fright"--but he means by this that he can play chess. He expresses an ability as if it were an experience.

Even if someone could do this or that only when, and only as long as, he feels this and that, the feeling would not be the capacity. [b: cf. *PI II*, vi, p. 181b]

Page 49

357. How do we compare the behaviour of anger, joy, hope, expectation, belief, love and understanding?--Act like an angry person! That's easy. Like a joyful one--here it would depend on what the joy was about. The joy of seeing someone again, or the joy of listening to a piece of music...?--Hope? That would be hard. Why? There are no gestures of hope. How does hoping that someone will return express itself?

Page 49

358. It's easy to imagine an animal angry, frightened, unhappy, happy, startled. But hopeful? [*PI II*, i, p. 174a]

Page 50

359. For hoping is quiet, joyful expectation. (Even though there is something repugnant about this kind of analysis.)

Page 50

360. A dog can expect its master, but can it expect its master will come the day after tomorrow? And what can he not do here?--How do I do it? How am I supposed to answer this? [*PI II*, i, p. 174a]

Page 50

361. The 'meaning' of a word is not the experience one has in saying or hearing it; and the 'sense' of a sentence is not a complex of the experiences which go with the words.

How do the meanings of the individual words make up the sense of the sentence "I still haven't seen him yet"? The sentence is composed of the words, and that is enough. [*PI II*, vi, p. 181c]

Page 50

362. The feeling for words. Suppose we found a man who, speaking of how words felt to him, told us that "if" and "but" felt the *same*. Should we have the right to disbelieve him?--Or should we just say that he isn't playing our game. It would be like someone who instead of associating a separate colour with each vowel, associated one colour with a, e, i and another with o and u. Maybe there are such people. [Cf. *PI II*, vi, p. 182b]

Page 50

363. One might say that such people would differ from us to a far greater extent than those who associated no colours at all with vowels. One would almost like to call them colour blind.

Page 50

364. And would such a person for that reason also confuse the uses of "if" and "that"?

Page 50

365. Can only those hope who can talk? Only those who have mastered the application of a language. The signs of hope are modes of this complicated pattern of life.†1 (If a concept applies to the character of handwriting, it has no application to beings that do not write.) [*PI II*, i, p. 174a]

Page 50

366. The glance which a word in a certain context casts at us.

Of course, the way in which it looks at us depends on the surroundings in which it is located.

367. Isn't the if-feeling *this* word, uttered with *this* tone and in *this* context?

368. The if-feeling cannot be something which *accompanies* the word "if". [Cf. *PI* II, vi, p. 182e]

369. Otherwise it could accompany other things too.

370. Suppose I were to speak of an if-gesture.

Could another word make the same gesture?--Or 'would it then not be the same gesture'?

371. The sound of the word "if" is simply part of the if-gesture.

372. Can two faces have the *same* expression? (Yes and no.)

373. The if-feeling would have to be compared with the special 'feeling' which a musical phrase gives us. (Someone might want to speak of a '*feeling* with a half-cadence'.) [Cf. *PI* II, vi, p. 182f]

374. But can this feeling be separated from the phrase? And yet it is not the phrase itself, for that can be heard without the feeling. [*PI* II, vi, p. 182g]

375. Is it in this respect like the 'expression' with which the phrase is played? [*PI* II, vi, p. 182h]

376. For one does not *mean* a feeling which accompanies the phrase, but at the most, the phrase *with* the feeling.

377. "He looked at me with a strange smile."--With what kind of smile?--To answer this I might have to draw his face.

378. The if-feeling is not a feeling which accompanies the utterance of the word "if". [*PI* II, vi, p. 182e]

379. We say this passage gives us a quite special feeling. We sing it to ourselves, and make a certain movement, and also perhaps have some special sensation. But in a different context we should not recognize these accompaniments--the movement, the sensation--at

all. They are quite empty except just when we are singing this musical phrase. [*PI* II, vi, p. 182i]

380. If we say "I sing it with a quite particular expression", then "expression" does not refer to something that I can separate from the passage.

In a different sense, it is conceivable for me to play a *different* phrase with the same expression. [Cf. *PI* II, vi, p. 183a]

381. The special feeling this passage gives me belongs to the passage, indeed to the passage in this context.

382. I can talk about the expression with which someone plays a passage without thinking that a different passage might have the same expression. Here this concept serves only as a means for comparing different performances of this passage.

383. The fact that we understand a sentence shows us that we could use it in certain circumstances (even if it were only in a fairy tale), but this does not show us *what* we can do with it and *how much*.

384. [non and ne.] They have the same purpose, the same use--with *one* qualification.

385. So are there essential and non-essential differences among the uses of words? This distinction does not appear until we begin to talk about the *purpose* of a word.

386. My kinaesthetic sensations advise me of the movement and position of my limbs.

Now I let my index finger make an easy pendulum-movement forward and backward. I either hardly feel it, or don't feel it at all. Perhaps a little in the tip of the finger, like a slight tension of the skin (not at all in the knuckle). And this sensation advises me of the movement? For I can describe it exactly. [*PI II*, viii, p. 185a]

Page 52

387. "But after all, you must feel the movement, otherwise you couldn't know how the finger was moving." But "knowing it" only means: being able to describe it.--I may be able to tell the direction from which a sound comes only because it affects one ear more

Page Break 53

strongly than the other; but I don't *hear* this. It only has the effect: I *know* where the sound comes from, and, for instance, I look in that direction. [*PI II*, viii, p. 185b]

Page 53

388. It is the same with the idea that it must be some feature of our pain that advises us of the whereabouts of the pain; or some feature of our memory image that tells us the point in time to which it belongs. [*PI II*, viii, p. 185c]

Page 53

389. A sensation *can* advise us of the movement of position of a limb. (For example, if with your eyes closed you were unable to tell, as a normal person can, whether your arm is stretched out, you might find out by a feeling of pressure in the elbow.)--And the character of a pain *can* also tell us where the injury is. [*PI II*, viii, p. 185d]

Page 53

390. How do I know that a blind person uses his sense of touch, and a sighted person his sense of sight, to tell them about the shape and position of objects?

Page 53

391. Do I *know* this only from my own experience, and do I merely surmise it in others?

Page 53

392. The evolution of the higher animals and of man and the awakening of the spirit, of consciousness, at a particular level. The picture is something like this: Though the ether is filled with vibrations the world is dark. But one day man opens his seeing eye, and there is light.

What this language primarily describes is a picture. What is to be done with the picture, how it is to be used, is still obscure. Quite clearly, however, this must be explored if we want to understand the sense of what we are saying. But the picture seems to spare us this work; it already points to a (very) particular use. This is how it takes us in. [*PI II*, vii, p. 184d]

Page 53

393. What is the criterion for my learning the shape and colour of an object from a sense-impression? [*PI II*, viii, p. 185e]

Page 53

394. *What* sense-impression? Well, *this* one: I can describe it: "It's the same one as the one..."--or I can demonstrate it with a picture.

And now: what do you feel when your fingers are in this position?--"How is one to define a feeling? One can only recognize it within

Page Break 54

oneself." But it must be possible to teach the use of the words! [*PI II*, viii, p. 185f]

Page 54

395. What I am looking for is the grammatical difference. [*PI II*, viii, p. 185g]

Page 54

396. Colour, sound, taste, temperature, all have a subjective and an objective side to them. And that undoubtedly means that sometimes they show what I feel, sometimes they describe the external world. Now my knowledge of the position of my body seems to be lacking the subjective link.

Page 54

397. You can't describe a feeling? Of course you can. You do it every day. But how? Well, we have to think about particular cases.

Page 54

398. If someone told me that he had then felt what you feel when you hold your fingers in *this* position, or move them *this* way, then I would imitate the position or movement and ask him, perhaps "Do you mean the feeling in your fingertips, or in your muscles or *here*?" That is, I needn't yet be clear what feeling he's talking about; indeed, I could even say "I'm feeling nothing when I move *this* way". Consider: I could also ask him "Is it a strong feeling, or a very weak one?" (But this remark is still peripheral, and doesn't yet get to the heart of the matter.)

399. And where is the K-feeling?†1 Can you point to it? (For the location of the receptors is of no concern to us.)

400. Let us leave the K-feeling out for the moment!--I want to describe a feeling to someone, and I tell him "Do *this*, and then you'll get it", and I hold my arm, or my head, in a particular position. Now is this a description of a feeling? And when shall I say that he has understood what feeling I meant? He will have to give a *further* description of the feeling afterwards. And what kind of description must it be?--Suppose that he tells me "Yes, I've got it. It's an extremely odd feeling". When he's asked "What kind of odd feeling? Where?", he says he can't say--it is quite strange. How would we know that it is a feeling? [Up to "Suppose that he tells" *PI* II, viii, pp. 185h-186a]

401. The 'further description' will connect the feeling up with other

feelings: It will have a location, will stay constant or change, will become stronger or weaker.

402. "Do *this*, and you'll get it." I hold my arm or my head in a certain position when I say this. Can't there be a doubt here? Mustn't there be one, if it is a feeling that is meant? [Cf. *PI* II, viii, p. 186b]

403. What would we say if someone reported to us that in a certain object he saw a colour he couldn't describe? Does he have to be expressing himself correctly? Does he have to mean a colour?

404. This looks so; *this* tastes so; *this* feels so: "this" and "so" must be differently explained. [*PI* II, viii, p. 186c]

405. Our interest in a 'feeling' is of a quite *particular* kind. It includes, for instance, the 'degree of the feeling' and the extent to which one feeling can be drowned out by another. [*PI* II, viii, p. 186d]

406. "Grief" describes a pattern which recurs in the weave of our life. Now a *process* is also part of this pattern. If a man's bodily expressions of sorrow and joy alternated, say with the ticking of a metronome, then this would not result in the pattern of sorrow or of joy. (This does not mean that joy or grief are kinds of behaviour.) [Cf. *PI* II, i, p. 174b]

407. If you observe your own grief, which senses do you use to observe it? A particular sense? One that *feels* grief? Then do you feel it *differently* when you are observing it? And what is the grief that you are observing, is it one which is there only while it is being observed?--'Observing' does not produce what is observed. (That is a conceptual stipulation.) [*PI* II, ix, p. 187a]

408. But I can still observe my grief, can't I? I ask myself, for instance, "Am I as sad today as I was yesterday?" and I answer that question.

409. I say (to myself), for instance: "A month ago I wouldn't have been able to think about it without shuddering."

410. If you trained someone to emit a particular sound at the sight of something red, another at the sight of something yellow, and so on for other colours, still he would not yet be able to describe objects by

their colours. Though he might be a help to us in giving a description. In order to describe he has to be able to make pictures of the way colours are distributed in space, following some rule of projection. (Language-g<ame>?)†1 [*PI* II, ix, p. 187d]

411. If I let my gaze wander round (a room) and suddenly it lights on an object of a striking red colour, and I cry out "Red!"--that is not a description of anything; even though I could give a description. [*PI* II, ix, p. 187e]

412. Are the words "I am afraid" a description of a state of mind?
It depends on the game they are in. [a: *PI* II, ix, p. 187f]

413. We are, of course, presupposing certain physiological phenomena that accompany this expression of fear, for he is supposed to be human, after all. A rapid pulse, laboured breathing, higher blood pressure, perhaps, and a series of neurological phenomena which are more difficult to observe; all of this is in turn accompanied by certain characteristic feelings. If someone breaks into a cold sweat then he has the sensations characteristic of sweating.

Page 56

414. And furthermore: it is quite possible that someone who imitates certain facial expressions, gestures, and sounds that are typical of fear and who in doing so becomes subject to one or the other of the feelings typically produced by these gestures--that this person might thereby induce further physiological manifestations of fear in his body, and along with these have even further sensations of fear.

Page 56

415. Indeed it *can* happen that play-acting fear produces fear. (It is not *necessarily* so, and it is not essential to fear.)

Page 56

416. The language-game of reporting can be given such a turn that a report is not meant to inform us about its subject matter but about the person making the report.

It is so when, for instance, a teacher examines a pupil. (You can measure to test the ruler.) [a: *PI* II, x, p. 190i; b: *PI* II, x, p. 191a]

Page Break 57

Page 57

417. "If my senses don't deceive me, he's coming from over there."

"If I'm not mistaken, he's coming from over there."

What is the hypothetical form of this?

Page 57

418. One can very well say "It looks to me as if he's coming, but he isn't".

Page 57

419. One can mistrust one's own senses, but not one's own belief. [*PI* II, x, p. 190f]

Page 57

420. One can even say: "I have the impression that he is coming, but he isn't."

Page 57

421. Suppose I were to introduce some expression, "I believe", for instance, in this way: It is to be prefixed to reports when they serve to give information about the reporter. (So "I believe" need not carry with it any suggestion of uncertainty. Remember also that the uncertainty can be expressed impersonally: "He might come today.")

Then what would "I believe it is so and it isn't" mean? [*PI* II, x, p. 191b]

Page 57

422. "I believe..." throws light on my state. Conclusions about my conduct can be drawn from this expression. So there is a similarity here to expressions of emotion, of mood, etc. [*PI* II, x, p. 191c]

Page 57

423. If there were a verb "to seem to believe" then it would not have a meaningful first person in the present indicative. (Our word "to dream" could also lack this form.)

Page 57

424. The best example of an expression with a very specific meaning is a passage in a play.

Page 57

425. Instantaneous motion. If you see motion you by no means see positions at distinct points in time. You could not copy it, or imitate it.

Page 57

426. "Back then I believed that the earth was a flat disc." A belief has a basis; the experiences, reports, relationships on which it rests. It stands on a ground.

Page 57

427. The line "x is in error" has no real point for x = myself.

At this point the line disappears into the dark.

Page Break 58

Page 58

428. For instance, the question can be raised: If I infer someone's state on the basis of his utterances, is this really the same state as one that is not recognized this way? And the answer is a decision.

Page 58

429. The phenomenon we are talking about is the dawning of an aspect.

Page 58

430. You say to yourself, for example, "It could be *this* too (you furnish a new interpretation) and the aspect may dawn.

Page 58

431. Two uses of the word "*see*". The one: "I see this"--and allude to a description, or point to a picture or a copy. With this I might tell someone else: over there, where you haven't been able to see it, there is such-and-such. An example of the other use: "I see a likeness between these two faces." Let the man I tell this to be seeing the faces as clearly as I do. [Cf. *PI II*, xi, p. 193a]

Page 58

432. The one man might make an accurate picture of the faces, and the other notice in the drawing their likeness, which the former did not see. [Cf. *PI II*, xi, p. 193b]

Page 58

433. I might be observing two faces which do not change: suddenly a likeness lights up in them. I call this experience the dawning of an aspect. [Cf. *PI II*, xi, p. 193c]

Page 58

434. Its causes are of interest to psychologists, but not to me. [Cf. *PI II*, xi, p. 193d]

Page 58

435. We are interested in the concept and its place among the concepts of experience.†1 [*PI II*, xi, p. 193e]

Page 58

436. The dawning of an aspect can be brought about, for example by (visually) going over certain facial lines.

Page 58

437. What is the characteristic expression of dawning? How do I know that somebody is experiencing this?- The expression is like an expression of surprise.

Page 58

438. An aspect dawns and fades away. If we are to remain aware of it, we must bring it forth again and again.

Page Break 59

Page 59

439. I suddenly see the solution of a puzzle picture. Before, there were twigs and branches there; now there is a human shape. My visual impression has changed and now I recognize that it has not only shape and colour but also a quite particular organization.--My visual impression has changed;--what was it like before; what is it like now?--If I represent it by means of an exact copy--and isn't that a good representation of it?--no change is shown. [*PI II*, xi, p. 196b]

Page 59

440. And above all do *not* say "After all, my visual impression isn't the *drawing*! It is *this*, which I can't show to anyone." Of course, it is not the drawing, but neither is it anything of the same category, which I carry within myself. [*PI II*, xi, p. 196c]

Page 59

441. So the copy cannot portray the aspect?--"Copy" means many different things.--The kind of copying *can* show the aspect that one sees. It can bring together what 'belongs together'. The particular *mistakes* a man makes when he is copying can also show the aspect he perceived.

Page 59

442. The concept of the 'inner picture' is misleading, for this concept uses the *outer* picture as a model, and yet their uses are no more closely related than the uses of 'numeral' and 'number'. If one chose to call numbers 'ideal numerals', one might produce a similar confusion.†1 [*PI II*, xi, p. 196d]

Page 59

443. If you put the organization of a visual impression on a level with shapes and colours, you are proceeding from the idea of the visual impression as an inner object. Of course, this makes the object into a chimera, a queerly shifting construction. For the similarity to a picture is now impaired. [*PI II*, xi, p. 196e]

Page 59

444. If someone sees a row of equidistant points as a row of pairs of points whose inner distance is smaller than the outer distance, he can then say that he sees the row as organized in a certain way. For the picture he might make of the row would have a particular organization. Of course, there might be a mistake here: he *thinks* that the row is organized that way.

Page 59

445. Organization: that refers to the spatial relationship, for instance. The representations of the, spatial relationships in a visual impression are spatial relationships in the representation of a visual impression.

Page Break 60

Page 60

By changing the spatial relations in the representation of what is seen, we *can* give a representation of a change of aspect. Example: the aspects of the diagram of a cube. The copy that is drawn is always the same, but the spatial one varies.

Page 60

446. The concept of a representation of what is seen, of a copy, is very elastic, and so *together with it* is the concept of what is seen. But the two are intimately connected. (Which is *not* to say that they are alike.) [PI II, xi, p. 198c]

Page 60

447. If someone looking at the model of a cube were to express himself this way: "Now I see a cube in *this* position--now one in *this*"--he could mean two very different things. Something subjective; or something objective. His words alone do not reveal which.--An account of a change of aspect has essentially the same form as an account of the object he saw. But its further application is different.

Page 60

448. If the aspect is a kind of organization and if the organization can be compared to the characteristics of shape and colour, then the change of aspect is like a change of the apparent colour.

Page 60

449. The concepts of colour and form must be learned objectively.

Page 60

450. The expression of an aspect follows the expression of perception, just as the expression of an *image* follows the expression of perception. But here we have to remind ourselves that a visual image cannot always be represented by describing a visual impression. For example, I can imagine a closed box, but the *picture* of the closed box could also represent several other things. (This is reminiscent of what we say in talking about a dream: "And I knew that...")

Page 60

451. *Seeing* an aspect is a voluntary act. We can tell someone: Now look at it like *this*. Try again to see the similarity. Listen to the theme *this way*, etc. But does that make seeing a voluntary act? Isn't it rather the way you look at something that causes this seeing?

For example, I can see the model of the cube in *this way* if I direct my glance right at *these* edges. When I do

this the aspect suddenly changes. Here I *know* how to *bring this about*. On the other hand, if I look at an  first one way and then another then I am unaware of this.

Page Break 61

Page 61

452. The aspect is dependent on the will. In this way it is like imagination. [Cf. PI II, xi, p. 213e]

Page 61

453. But visual *perception* is also dependent on the will, after all! If I look more closely then I see something different and I can produce the other visual impression at will. To be sure, this does not make the impression an aspect--but isn't it, too, subject to my will?

Page 61

454. Someone who has always taken a certain shape for a printed F need never have had the experience that is expressed in the words: "Now I see it as an F".

This aspect has not necessarily 'dawned' on him.

Page 61

455. Someone who is looking at the d<uck>-r<abbit> and thinking about the facial expression on the rabbit--trying, for example, to find the right word for it--this person is looking at the picture in the rabbit aspect, but this rabbit aspect does not dawn on him.

But then is it correct to say that he *sees* the picture in this aspect the whole time?

Now he describes what he sees as the head of a rabbit, for that is the way he talks, for instance, about what he sees.

Page 61

456. Do not ask yourself "How does it work with *me*?" Ask "What do I know about someone else?" [PI II, xi, p. 206c]

457. Do not ask yourself "Didn't I *see* it in such a case?"--but rather "What makes me say that *he* sees it in this case?"

458. If I heard someone talking about the duck-rabbit, and now he spoke in a certain way about the special expression of the rabbit's face I should say "Now he's looking at the picture as a rabbit's head", or "under the rabbit aspect". [PI II, xi, p. 206h]

459. The greatest danger here is wanting to observe oneself.

460. If I say "These two shapes seemed to me to have no *similarity* to each other at all", can I use a stronger expression for the fact that I *saw* something different each time?

461. He sees two pictures, for instance, with the duck-rabbit surrounded by rabbits in one, by ducks in the other. He doesn't notice that they are the same. Does it *follow* from this that he *sees*

something different in the two cases?--It gives us a reason for using this expression here. [PI II, xi, p. 195e]

462. And how about the statement "I *saw* it quite differently! "? Well, maybe that shows that here this concept suggests itself to someone and that too is understandable.

So I had 'seen' it; even though this aspect had never dawned on me.

463. And now how does this chronic†1 'seeing-as' compare with colours and shapes? Has my visual image always had these colours, these shapes, this organization? So far it has only been a mode of expression; but just how similar are these concepts?

Of course, we can say "There are certain things which fall equally under the concept 'picture-rabbit' and under the concept 'picture-duck'. And a picture, a drawing, is such a thing."--But the *impression* is not simultaneously of a picture-duck and a picture-rabbit. [b: PI II, xi, p. 199f]

464. You had learned: *that* is 'red'; *that* is 'round'; *that* is a 'rabbit'.

465. I learned the concepts 'red', 'round', 'picture-rabbit', 'picture-duck'--so far they are more or less on the *same* level. I can learn them from samples.

466. A picture-rabbit is *something like this*: and then I point to examples. So a picture-duck is something *different*, even if *one* of the examples is the same.

467. If I saw the duck-rabbit as a rabbit, then I saw: This shape and colour (I reproduce them *exactly*)--and I saw besides something like this: and here I point to a number of different pictures of rabbits. This demonstration shows the difference between the concepts. [PI II, xi, pp. 196h-197a]

468. "I saw it *quite* differently, I should never have recognized it!" Now that is an exclamation. And there is also a justification for it. [PI II, xi, p. 195f]

469. All the while you would have copied this face (the imitation of a rabbit), so in *one* sense you did see it *that* way after all.

470. And if I see it now as a rabbit, now as a duck, then I see it *this*

way and *this* way (when I say this each time I imitate a different animal and look in a different direction).

471. What kind of man is said to be enjoying this picture's telling expression? Well, someone who looks at it this way, talks about it in such-and-such a way, and reacts to it this way.

472. I have always seen it as a rabbit could even mean: for me it always was a rabbit, I have always spoken to it as a rabbit. A child does this.

It means that I have always *treated* it as a rabbit.

Page 63

473. Now if the child treats the picture of the rabbit like a real rabbit, does that show something about how the visual picture is organized? Is *that* proof that a child sees more than just colours and shapes?

Page 63

474. And now the change of aspect.

The experience of the *new* aspect. Or: of the *appearance* of the aspect. And the expression of this is an exclamation. A rabbit! etc.

Page 63

475. "But surely you would say that the picture is altogether different now!" [PI II, xi, p. 195i]

Page 63

476. But what is different: my impression? my point of view?--Can I say? I *describe* the alteration like that of a perception; quite as if the object had altered before my eyes. [PI II, xi, p. 195i]

Page 63

477. Imagine the duck-rabbit cut out and a child treats it as a doll, now *this* way and now *that*.

Page 63

478. I am shown a picture-rabbit and asked what it is; I say "It's a rabbit". Not "Now it's a rabbit". I am reporting my perception. I am shown the duck-rabbit and asked what it is; I *may* say "It's a duck-rabbit". But I may react to the question quite differently.--If I say that it is a duck-rabbit this again is the report of a perception; but if I say "Now it's a rabbit", then it isn't. Had I replied "It's a rabbit", I would not have noticed the ambiguity, and I should have been reporting my perception. [PI II, xi, p. 195h]

Page 63

479. But then isn't there a difference between the *first* "Now it's a rabbit" and the newly developing aspect?

Page Break 64

Page 64

480. A wall covered with spots; and I occupy myself by seeing faces on it; but not so that I can study the nature of an aspect, but because I find those *shapes* interesting and because of the destiny that leads me from one to the next.

More and more, aspects dawn, others fade away, and sometimes I 'stare blindly' at the wall.

Page 64

481. The double cross and the duck-rabbit might be among the spots and they could be seen, like the other figures, and together with them, under various aspects.

Page 64

482. The aspect *seems* to belong to the structure of the inner materialization.

Page 64

483. We learn language-games. We learn how to arrange objects according to their colours, how to report the colours of things, how to produce colours, compare shapes, measure, etc., etc.--Do we learn how to form mental images out†1 of them?

Page 64

484. There is a language-game: "Tell me whether (sometimes also "how often" and "where") this figure is contained in that one." What you report is a perception.

Page 64

485. So we could also say: "Tell me whether there is a mirror-F here", and suddenly it might strike us that there is. This could be very important.

Page 64

486. But the report "Now I see it as..." does not report any perception.

Page 64

487. "You can think now of *this*, now of *this*, as you look at it, can regard it now as *this*, now as *this*, and then you will see it now *this* way, now *this*." *What* way? There is no further qualification. [PI II, xi, p. 200d]

Page 64

488. I can change the aspects of F and in so doing I do not have to be cognizant of any other act of volition.

Page 64

489. In these considerations it is useful to introduce the idea of a 'picture-rabbit', 'picture-man', etc. For instance,



is a picture-face. [Cf. *PI* II, xi, p. 194c]

Page Break 65

Page 65

490. "Now I am seeing *this*", I might say. This is the report of a *new* perception. †1 [*PI* II, xi, p. 196a]

Page 65

491. But what if, to begin with, I drew exactly what I perceived; and then said: "Now I see that it is a rabbit", or "Oh, it's a rabbit!" Now I am expressing an experience that occurs at the same time as the exclamation.

Page 65

492. The perception of an internal relation and the dawning of the aspect of an internal relation.

Someone has always seen the duck-rabbit as a rabbit and now he sees it as a duck for the first time. From this he might learn that a rabbit's head and a duck's head can have the same contours. Under certain circumstances this can be an important discovery. (I'm thinking of a code in which a rabbit's head is a sign.) But the dawning of the rabbit aspect is not the perception of that relation.

Couldn't someone perceive the relation and still not be able to experience the change or the dawning of an aspect?

Page 65

493. In one case you say: "What I have in front of me is *this* [copy]. I can also describe it as a rabbit."--In another case: Before, I saw something else, but now I see a rabbit.

Page 65

494. The expression of a change of aspect is the expression of a *new* perception, and at the same time of the perception's being unchanged. [*PI* II, xi, p. 196a]

Page 65

495. The copy *completely* describes the perception. The model that I am pointing to describes the *kind* of view I now have of it. And one could also say: the visual experience.--In that case the copy is a more precise report of the perception. But if the aspect *dawns* upon me, then its expression (for example, my pointing to the model) is *essentially* the expression of a new perception.

Page 65

496. Just as if we had to have a new copy now, to correspond to this expression. But this is not the case.

Page 65

497. I ask: "What are you seeing?" The other person starts drawing; then he gives up and says "I can't draw it very well; it's a rabbit sitting down". Then I might improve on his drawing.

Page 65

498. "I see a picture-rabbit. And that is *exactly* what I see [and now I'll draw it]."

Page Break 66

Page 66

499. Then is the copy an *incomplete* description of my visual experience? No. But the circumstances decide what more detailed specifications I need to make. It *may* be an incomplete one; if there is still something to ask. (Example: the schematic cube.) [*PI* II, xi, p. 199e]

Page 66

500. So pointing to the model, in *addition* to the copy, might belong to the description of the visual experience. But then it doesn't belong to the description of the visual perception.

Page 66

501. If I know that the schematic cube has various aspects and I want to find out what someone else sees, I can get him not only to copy the schematic cube, but also to point to a cube; even though *he* has no idea why. To *me* it describes what he sees. †1 [*PI* II, xi, p. 196f]

Page 66

502. But when we have a changing aspect the case is altered. Now the only possible expression of our experience is what before perhaps seemed, or (even) was, a useless specification when once we had the copy. [*PI* II, xi, p. 196f]

Page 66

503. And this by itself eliminates for us the comparison of 'organization of the visual impression' with colour and shape. [*PI* II, xi, p. 196g]

Page 66

504. Indeed, I confess, nothing seems more possible to me than that people some day will come to the definite opinion that there is no copy in either the physiological or the nervous systems which corresponds to a *particular* thought, or a *particular* idea, or memory.

Page 66

505. What would it be like, what would it look like, if all choice were taken out of an aspect?

Page 66

506. Does "seeing an aspect" mean that one perceives the internal relation? What is there in me that speaks against this?

Page 66

507. If you search for figure (1) in another figure (2), and then find it, you see (2) in a different way, one can say. Not only can you give a new kind of description of it, but noticing the first figure was a new visual experience. [PI II, xi, p. 199b]

Page Break 67

Page 67

508. But you would not necessarily want to say: "Figure (2) looks quite different now; it isn't even in the least *like* the figure I saw before; though they are congruent!" [PI II, xi, p. 199c]

Page 67

509. "The inner picture contains colours, shapes, and, what is more, a particular organization." From this it would follow that it looks like *this* and not like *that*.

Page 67

510. You *notice* an organization of an *object* (an object of perception). Or rather: You notice something about its organization; a feature of this organization.

Page 67

511. Noticing is a visual experience.

Page 67

512. You can copy colour and shape. You can point to a sample of colour and shape. But you can't point to a sample of the visual impression's organization.

Page 67

513. Someone might say, for instance: "If you want the same impression I have you have to look at this figure, particularly at this part, and you have to look so that you notice *this* about it." But that isn't what we do. This sort of thing is not what we call "describing a visual impression", just as we don't prescribe how the other person's gaze should travel across the object when we try to describe our visual impression. This shows us <that> "visual impression" is supposed to refer to something like "visual *picture*", and that this in turn is supposed to refer to something like a picture.

Page 67

514. If you ask me what I saw, perhaps I shall be able to make a sketch which shows you, but I shall mostly have no recollection of the way my glance travelled in looking at it. [PI II, xi, p. 199h]

Page 67

515. The colour of the visual impression corresponds to the colour of the object, the shape of the visual impression to the shape of the object. But the aspect of the visual impression does not correspond to the organization of the object, for the *former* can vary while the same organization is being looked at. In the aspect I notice a trait of the organization.

Page 67

516. The colour in the visual impression corresponds to the colour of the object (this blotting paper looks pink to me, and is pink)--the shape in the visual impression to the shape of the object (it looks rectangular to me, and is rectangular)--but what I perceive in the

Page Break 68

dawning of an aspect is not a property of the object, but an internal relation between it and other objects. [PI II, xi, p. 212a]

Page 68

517. Imagine the duck-rabbit hidden in a mass of lines. Now I suddenly notice it in the picture, and notice it simply as a rabbit. At some later time I look at the same picture and notice the same figure, but see it as the duck, without necessarily realizing that it was the same figure both times. If I later see the aspect change, can I say that the duck

and rabbit aspects are now seen quite differently from when I recognized them separately in the tangle of lines? No.

But the change produces a surprise not produced by the recognition. [PI II, xi, p. 199a]

Page 68

518. The aspect only dawns; it doesn't remain fixed. But that has to be a conceptual, and not a psychological, remark.

The expression of seeing an aspect is the expression of a *new* perception.

Page 68

519. (Seemingly, I am performing 'thought-experiments'. Well, they're simply not experiments. Calculations would be much closer.)

Page 68

520. The expression of the dawning of an aspect is: "Now it's *this*--now it's *that*." The expression of noticing the rabbit in the tangle of lines is: "There is a rabbit here." We have not noticed something and now we do; there's nothing paradoxical about this. We don't want to say that the old has vanished--that there's something new there, though it's entirely the old.

Page 68

521. We don't say "Now it is *this*" *before* the first change of aspect.

Page 68

522. A hesitant assertion is not an assertion of hesitancy. [Cf. PI II, x, p. 192]

Page 68

523. Think of a hesitant command.

Page 68

524. And one should be on one's guard against saying that "It may be raining" *really* means "I think it'll be raining". Why then shouldn't it be the other way round? [PI II, x, p. 192h]

Page 68

525. Aristotelian logic brands a contradiction as a non-sentence,

Page Break 69

which is to be excluded from language. But this logic only deals with a very small part of the logic of our language. (It is as if the first geometrical system had been a trigonometry; and as if we now believed that trigonometry is the real basis for geometry, if not the whole of geometry.)

Page 69

526. Don't regard a hesitant assertion as an assertion of hesitancy. [PI II, x, p. 192i]

Page 69

527. "I noticed the likeness between the two for perhaps five minutes." That might be said if they were to change.--That would mean: I was aware of it for about five minutes, it occupied me for 5 minutes, and throughout this time I continually had to think of it.

"It struck me for five minutes, and no longer after that." "The likeness staggered me for five minutes. I had to exclaim again and again..." That does not mean: I observed it for five minutes and then it disappeared.

<In English> "The similarity struck me for 5 minutes."

"The similarity staggered me for 5 minutes. After that I no longer noticed it."†1 [a: cf. PI II, xi, p. 210f]

Page 69

528. "I observed this similarity for 5 minutes" would mean: I was observing the similarity of the changing faces.

Page 69

529. The organization of a visual picture: *this* belongs together, *that* doesn't. So one organizes by bringing together and separating. Well, this can be done when drawing, for instance.

Page 69

530. There are quite different kinds of 'aspects'. One kind might be called "aspects of organization". [Cf. PI II, xi, p. 208d]

Page 69

531. The lines are connected together differently. What belonged together before doesn't belong together now.

Page 69

532. I may, then, have seen the duck-rabbit as a picture-rabbit from the first. That is to say, if asked: "What's that?" or "What do you see here?" I should have replied "A picture-rabbit". If I had further been asked what a picture-rabbit was, I should have had to explain by pointing to various pictures of rabbits or to real rabbits, could have talked about their habits and given an imitation of them. [PI II, xi, p. 194d]

533. I should not have said "I am seeing that as a picture-rabbit" or "Now I am seeing it as a picture-rabbit". I should simply have described my perception; just as if I had said "I see a red circle there". Nevertheless someone else could have said of me "He's seeing this figure as a rabbit". [Cf. *PI* II, xi, pp. 194e-195a]

534. It would have made as little sense for me to say "Now I'm seeing it as..." as to say at the sight of a bottle of wine "Now I'm seeing this as a bottle". This expression would not be understood. Any more than the expression from <unharmed>† I skin "Now it's a bottle", or "It can be a bottle too". [Cf. *PI* II, xi, p. 195b]

535. Neither could one normally say "I take that to be a knife and fork".

536. One doesn't *take* what one knows as a knife and fork at a meal *for* a knife and fork; any more than one ordinarily tries to eat as one eats, or aims to eat. [Cf. *PI* II, xi, p. 195c]

537. Does the dog who suddenly notices a rabbit *think* of it?

538. Suppose someone is taking a walk and suddenly an animal crosses his path: I see him looking surprised--what do I know about his experience?

When asked he might say "All of a sudden something startled me; I don't know what it was." Or: "Suddenly I saw something that flitted by--that was all." Or: "It was a rabbit!"

539. Suppose he had never seen an animal: Then would his visual experience differ from that of someone who is familiar with the shape of the animal that flitted by? (I would like to answer in the affirmative, but I don't know why.)

540. The question can be put another way: Someone suddenly sees an object which he does not recognize; (it may be a familiar object, but in an unusual position or lighting); the lack of recognition perhaps lasts only a few seconds. Is it correct to say he has a different visual experience from someone who knew the object at once? [*PI* II, xi, p. 197e]

541. Can't we imagine that someone is able to describe a completely unfamiliar shape that appears before him just as *accurately* as I, to whom it is familiar? And isn't that the answer? Of course, it will not generally be so. And his description will run quite differently. (I say, for example, "The animal had long ears"--he: "There were two long appendages" and then he draws them.) [*PI* II, xi, p. 197f]

542. Here we must be careful not to think in traditional psychological categories. Such as simply dividing experience into seeing and thinking; or doing anything like that.

543. One feels inclined to ask "Is recognizing a part of seeing?" And the question is wrongly put.

What are the signs of recognizing--what are those of seeing?

If someone suddenly sees his friend in a crowd and calls out his name, what is he giving a sign of?

544. I see someone whom I have not seen for years, I see him clearly, but fail to know him. Suddenly I know him, I see the old face in the altered one. I believe that I could do a different portrait of him now. [*PI* II, xi, p. 197g]

545. Clearly there is a relationship between concepts here.

546. Isn't it possible for someone to describe a face with which he is completely unfamiliar more accurately than I might describe one I've known for a long time?

547. (And here one must distinguish between the experience of recognizing something again and recognizing, which is simply a being-familiar-to-me.)

548. Do not try to analyse your own inner experience! [*PI* II, xi, p. 204e]

Page 71

549. I look at an animal in a cage. I am asked: "What do you see?" I answer: "A rabbit."--I gaze into the countryside; suddenly a rabbit runs past. I exclaim: "A rabbit!"

Both things, both the report and the exclamation, can be called expressions of perception and of visual experience. But the exclamation is so in a different sense from the report; it is forced from us. It is

Page Break 72

related to the experience as a cry is to pain. [*PI* II, xi, p. 197b]

Page 72

550. But isn't it simply that the exclamation, that is, the particular inflection of the words, is merely an expression of surprise. The words themselves are the expression of the visual perception, etc., just as are the words of a report.

My surprise might also have been expressed by an inarticulate sound; and if I am asked "Why did you flinch?", I might answer: "A rabbit crossed in front of me."

Page 72

551. Another exclamation might have been: "What was that?!"

Page 72

552. But are the two experiences whose expressions are the inarticulate sound and the exclamation "A rabbit!" really the same? How should I decide this? (*I* didn't mean the same thing.)

Page 72

553. But since it (the exclamation) is the description of a perception, it can also be called the expression of a thought. And therefore we can say that if you are looking at the object, and see it, you need not think of it; but if you are having the visual experience expressed by the exclamation, you are also thinking of what you see. [*PI* II, xi, p. 197c]

Page 72

554. And that is why the experience of a change of an aspect^{†1} seems half visual-, half thought-experience.^{†2} [*PI* II, xi, p. 197d]

Page 72

555. When I see a change of aspect I have to occupy myself with the object.

Page 72

556. I occupy myself with what I am now noticing, with what strikes me. In that respect, experiencing a change of aspect is similar to an action.

Page 72

557. Does the exclamation "What was that?" express a particular visual experience?

Page 72

558. Couldn't we answer: Yes and No?

Page 72

559. "I just saw a shadow flitting by." Isn't that the expression of a visual experience?

Page Break 73

Page 73

560. I see a 'questionable' shape.

Page 73

561. But can you really say that you see the questionableness *and* the shape?

Page 73

562. Question: *What supports this?*

Well, the fact that even the description I give of the phenomenon is moulded by the questionableness.

Page 73

563. What is the criterion of the visual experience? The criterion? What do you suppose?

The representation of 'what is seen'. [*PI* II, xi, p. 198b]

Page 73

564. Now when the aspect dawns, can I separate a visual experience from a thought-experience?--If you separate them the dawning of the aspect seems to vanish.

Page 73

565. I think it could also be put this way: *Astonishment* is essential to a change of aspect. And astonishment is thinking.

Page 73

566. But isn't that just MY conception of a change of aspect?

Page 73

567. So *what* dawns? The aspect of the rabbit for instance. And therein, that it could only be expressed that way, lay the thought.

Page 73

568. Something flying by might surprise me *bodily*, as it were, and yet I needn't *think* about it. That is, even though I gave a start, I could still continue a train of thought.

Page 73

569. But now think of the aspects of the rotating drum. When they change, it seems as if the *movement* had changed. Here one doesn't necessarily know whether it is the kind of movement that has changed, or the aspect. And therefore we don't in the same sense have the experience of the change of aspect.

Page 73

570. Imagine that two lights, one blue and one red, are alternately blinking in front of my eyes. I am to press one button when the blue light flashes, another when the red light flashes. Certainly I could do this quite mechanically.--And now imagine that this game is played with the two aspects of the black-white cross. Now is it impossible that there be equally mechanical and thoughtless reactions?

Page Break 74

Page 74

571. Now when I know this person in a crowd, perhaps after looking in his direction for quite a while--is this a sort of seeing? A sort of thinking? The expression of the experience is "Look, there's ...!"--But, of course, it could just as well be a sketch. That I recognize this person might be expressed in the sketch or in the process of sketching as well. (But the element of sudden recognition is not expressed in the sketch.)†1

The very expression which is elsewhere a report of what is seen, is here a cry of recognition. [a: cf. *PI* II, xi, p. 197h; b: p. 198a]

Page 74

572. Suppose a child suddenly recognizes someone. Let it be the first time he has ever suddenly recognized anyone.--It is as if his eyes had suddenly opened.

One can ask, for example:†2 If he suddenly recognizes N. N., could he have the same visual experience, but without recognizing him? For instance, he could be *mistaken* about recognizing him.

Page 74

573. What if someone were to ask: "So I do that with my eyes?"

Page 74

574. A rabbit runs across a path. Someone who isn't familiar with rabbits says: "Something strange just whizzed by" and he proceeds to describe the appearance. Someone else exclaims "A rabbit!" and he cannot describe the appearance so precisely.

Now why do I still want to say that the person who recognizes it sees it differently from the person who doesn't?

Page 74

575. If someone sees a smile and does not know it for a smile, does not understand it as such, does he see it differently from someone who understands it? He mimics it differently, for instance. (Understanding the modes in ecclesiastical music.) [*PI* II, xi, p. 198e]

Page 74

576. *What can be cited in support of his seeing it differently?*

Page 74

577. "It looks different to anyone who knows what it is."--How so?

Page 74

578. What would it be like if someone just wasn't acquainted with what it was that scampered by, but still knew all about it right away? Does he then see it in the same way as a person who is acquainted with it?

Page Break 75

Page 75

579. It's a question of the fixing of concepts.

Page 75

580. I'm mentioning these kind of aspects in order to show the kind of multiplicity we are dealing with here.

Page 75

581. There are here hugely many interrelated phenomena and possible concepts. [PI II, xi, p. 199d]

Page 75

582. Sometimes the conceptual is dominant in an aspect. That is to say: Sometimes the experience of an aspect can be expressed only through a conceptual explanation. And this explanation can take many different forms.

Page 75

583. The various kinds of aspects.

Page 75

584. Hearing a melody and the movements that go along with the particular way someone interprets or hears it.†1

Page 75

585. Why does it seem so hard here to separate *doing* and experiencing?

Page 75

586. It's as if doing and the impression didn't happen side by side, but as if doing shaped the impression.

Page 75

587. I hear it differently, and now I can play it differently. Thus I can render it differently.

Page 75

588. There are many ways of experiencing aspects. What they have in common is the expression: "Now I see it as *that*"; or "Now I see it *this way*"; or "Now it's *this--now that*"; or "Now I hear it as...; a while ago I heard it as ...". But the explanation of these "*that's*" and "*this way's*" is radically different in the different cases.

Page 75

589. What would it be like if suddenly I noticed a lion out of doors? I'll assume that I see only part of its head, but that I recognize it immediately and cry out "A lion!" The most powerful feeling in me is fear.--And now I ask again: What about the visual impression? Was it different from the one I receive in the zoo? (Aside from the fact that the latter impression is much more complete.--)

Page 75

590. (I can't yet lift myself above the mass of appearances.)

Page Break 76

Page 76

591. Here it is *difficult* to see that what is at issue is the fixing of concepts.

The *concept* forces itself on one. (This is what you must not forget.) [PI II, xi, p. 204h]

Page 76

592. The visual impression seems to organize itself in this way.

Page 76

593. This really means: the visual impression changed, and didn't change.

Page 76

594. When I suddenly recognized him my visual impression suddenly seemed to change into *this*.

Page 76

595. Was it a sort of understanding? Was it a sort of seeing?



Page 76

596. What, if anything, justifies my talking about seeing here?

Page 76



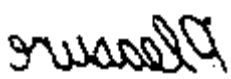

597. Suppose someone were to tell me: "It was as if my visual impression suddenly organized itself into this face and its surroundings." I would understand him. I would comprehend why he was expressing himself this way. That is, I too would be inclined to use this image.

Page 76

598. This figure  is the reverse of  and this:  is the reverse of this:

 . One is inclined to say that one *sees* the reverse word differently from the normal word. The latter is easy to copy, the former difficult. [Cf. PI II, xi, p. 198g]

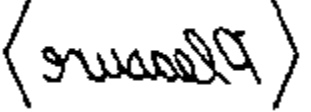
Page 76

599. The figure a)  is the reverse of figure b)  as the figure c)  is the reverse of d) . But--I should like to say--there is a further difference between my impressions of c and d and those of a and b. (d, for example, looks neat, and c sloppy. Cf. Lewis Carroll's 'Looking glass'.) d is easy, c hard to copy. [PI II, xi, p. 198g]

Page 76

600. What previously fell apart in a visual impression now belongs together.

Page Break 77

Page 77

601. How would the following account do: "What I can see something *as*, is what it can be a *picture* of"?--But is that an explanation or a pleonasm?--[PI II, xi, p. 201b]

Page 77

602. What it means is: The aspects in a change of aspects are those ones which the figure might sometimes have *statically* in a picture. [PI II, xi, p. 201b]

Page 77

603. A triangle can really be standing up in one picture, be hanging in another, and can in a third be something that has fallen over. That is, I who am looking at it say, not "It may also be something that has fallen over", but "That pitcher has fallen over and is lying there in fragments". This is how we react to the picture. [PI II, xi, p. 201c]

Page 77

604. Could I say what a picture must be like to produce this effect? No. There are, for example, styles of painting which do not convey anything to me in this immediate way, but do to someone else. I think custom and upbringing have something to do with this. [PI II, xi, p. 201d]

Page 77

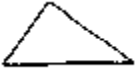
605. Take as an example the aspects of a triangle. This triangle  can be seen as a triangular hole, as a solid, as a geometrical drawing; as standing on its base, as hanging from its apex; as a mountain, as a wedge, as an arrow or pointer; as an overturned object which (for example) is meant to stand on the shorter side of the right angle, as a half parallelogram, and as various other things. [PI II, xi, p. 200c]

Page 77

606. What does it mean to say that I see the sphere floating in the air in a picture?

Is it enough that I describe the picture this way? That this description is the first to hand, is the most natural for me? No, for it might be so for various reasons. This might, for instance, simply be the conventional description. [PI II, xi, p. 201e]

Page 77

607. What is the expression of my not merely understanding the picture in this way, for instance (knowing that it is *supposed* to be), but *seeing* it in this way?

It is expressed by: "The sphere seems to float", "You can see it floating", or again, in a special tone of voice, "It floats!"

This then is the expression of taking something for something. But not being used as such. [PI II, xi, p. 201e]

Page Break 78

Page 78

608. Here we are not asking ourselves what are the causes and what produces this impression in a particular case. [PI II, xi, p. 201f]

Page 78

609. And is it a different impression?--"Surely I see something *different* when I see the sphere floating from when I merely see it lying there."--This really means: This expression is justified! (For taken literally it is no more than a repetition.) [PI II, xi, p. 201g]

Page 78

610. (And yet my impression is not that of a real floating sphere either. Compare the various kinds of 'three-dimensional' seeing; the three-dimensional character of a normal photograph and that of what we see through a stereoscope.) [PI II, xi, p. 202a]

611. "And is it really a different impression?" In order to answer this I should like to ask myself whether there is really something different there in me. But how can I find out?--I *describe* what I am seeing differently. [PI II, xi, p. 202b]

612. We can produce a change of aspect, and it can also occur against our will.
Like our gaze, it can follow our will.

613. When you ride a bus at night and it makes a turn, if you look at the front partition (which doesn't move relative to the passengers), you'll think that you're *seeing it* make the turn. You feel, of course, that the vehicle is making the turn. And you may also have an inkling of this from the darkness outside, which you still see, although unconsciously, out of the corner of your eye. But you think you see the front partition making the turn, and *at the same time*, of course, you see that it's not moving with respect to you.

614. (Rhees) If someone describes his present mood and says, for instance, that it is like a grey cloud--isn't he observing it even though his observation might change it somewhat? And does what I said about 'description' in general hold true for this description?

615. Don't I look into myself and say: "What is the right word for this feeling, this mood?"--And is it clear that my mood isn't intensified, for instance, by this looking?

Isn't it possible for me to *revel* in a mood? And couldn't self-observation be a part of this revelling?

616. Is this similar to causing myself physical pain (no matter how I do it) and then trying to describe exactly what it's like?

617. Suppose I say in a case like that: "Yes, this pain is like a blazing fire."

618. In which way and in which sense am I observing the pain? (For I can't see any difference between someone observing his sadness and observing his own pain.) I put myself in a position to feel it. But *what* pain? *This* kind--or the pain produced in *that* way?

Do I say "I'd like to reproduce this same blazing pain so I can see what it is *like*?"†1 Why should I observe it if I can identify it this way? Well, you might say: "If I could just feel this same pain again and again, then I would finally hit upon the right word for it, or even the coloured image (for example, that of a fire)."

And now I can simplify the case. He doesn't even have to produce the pain on purpose; rather, let it be a constant pain (a headache or stomach-ache) and let him be thinking about how to describe his feeling correctly.

619. What I really want to say is that by looking I do not observe my *visual impression*, but rather whatever I am looking at.

620. So if I somehow look at my grief then I am not observing the impression that I thereby receive.

621. But suppose I stare fixedly at an object and ask myself "What kind of red am I seeing there?" I'm not interested in the colour of the object at all, but just searching (perhaps) for a name for my present impression of it.

Can I say that to think about an impression is not to 'observe it'?

622. What does someone who says "Now I see it as..." convey to us? That is, what follows from this report, what sort of use does it have? It could have many different kinds of consequences.

Well, for example anyone who sees the d<uck>-r<abbit> as a rabbit will not be able to describe the expression of the duck.

Three-dimensional seeing in solid geometry. Anyone who sees the model of the curve as flat won't be able to

perform various graphic operations with it. [Not quite right.]

Page 80

623. Connection with the game "That could be a...".

Page 80

624. What are you telling me when you use the words...? What can I do with this utterance? What consequences does it have?

Page 80

625. Certain drawings are always seen as flat and others sometimes, or even always, three-dimensionally. [*PI II*, xi, p. 202c]

Page 80

626. Here one would not like to say: The visual impression of what is seen three-dimensionally is three-dimensional; with the schematic cube, for instance, it is a cube. (For the description of the impression is the description of a cube.) [*PI II*, xi, p. 202c]

Page 80

627. "Now I always see it as ..." Before I erroneously saw this as...; but now no longer. Now I always see it the way it was meant.--How does this get expressed?

Page 80

628. And then it seems queer that with some drawings our impression should be a flat thing, and with some a three-dimensional thing. One asks oneself: "Where *is* this going to end?" [The picture of a runner.] [*PI II*, xi, p. 202d]

Page 80

629. "What does this colour remind me of?"--Is a person who looks at an object and asks himself that question observing the visual *impression*?†1

Page 80

630. What does anyone tell me by saying "Now I see it as ..."? What consequences has this information? What can I do with it? [*PI II*, xi, p. 202f]

Page 80

631. People often associate colours with vowels. Someone might find that a vowel changed its colour when it was repeated several times. The vowel *a* would be 'now blue--now red'.

"Now I am seeing it as..." might have no more significance for us than "Now *a* is red".

Page Break 81

Page 81

(Linked with physiological observations, even this change might acquire importance for us.) [*PI II*, xi, p. 202g]

Page 81

632. If I ask myself of what use, of what interest that report is, I remember how often it is said in aesthetic observations:†1 "You have to see it like *this*, this is how it is meant", "When you see it like *this*, you see where it goes wrong", "You have to hear these bars as an introduction", "You must hear it in this key", "You must phrase the theme like *this*" (which can refer to hearing as well as to playing). [*PI II*, xi, p. 202h]

Page 81

633. The figure  is supposed to represent a convex step and to be used in some kind of topological

demonstration. In this context we draw the line *a* through the geometric centres of the two surfaces.  --Now if anyone's three-dimensional impression of the figure were never more than momentary, and if even then he sometimes saw it as a concave step, that might make it difficult for him to follow the demonstration. (Just as a person who cannot see projections three-dimensionally will have a hard time with solid geometry.) (The role of intuition in mathematics.) And if he finds that the flat aspect alternates with a three-dimensional one, that is just as if I were alternately to show him completely different objects (now something flat, now one model, now another). [*PI II*, xi, p. 203a]

Page 81

634. But the application, after all, is completely different in aesthetics and descriptive geometry. In aesthetics isn't it

essential that a picture or a piece of music, etc., can change its aspect for me?--And, of course, this is not essential for that topological demonstration.

Page 81

635. "If I see it *this* way, it fits, but if I see it *that* way, it doesn't."

Page 81

636. A game: "It can also be ..."

Page 81

637. "But this isn't *seeing!*"--"But this is *seeing!*"--It must be possible to give both remarks a conceptual justification. [PI II, xi, p. 203c]

Page Break 82

Page 82

638. The question is: *In what sense* is it seeing? [PI II, xi, p. 203d]

Page 82

639. "Do you always *see* this leaf as *green*, that is, as long as you are looking at it and would truthfully answer the question as to its colour by saying "green"?" Is the sense of this question clear? One answer might be: "Well, I don't say to myself, 'Oh, how *green!*' the whole time I am looking at the leaf."

Page 82

640. How is it expressed that I see this picture as a picture of snow-covered trees? That I not only *know* that it represents them, but that I don't *read* the picture like a blue-print?--I treat it differently. (Child and doll.)

Page 82

641. If I see an animal in a picture pierced by an arrow, do I only *know* that the point of the arrow is connected with its feathers, or do I *see* it?--I *relate* to these bits as I would to an arrow. That is: I don't merely say, as if I were deciphering the diagram of a machine, "These two bits go together, and this is where a shaft goes through"; rather if I'm asked "What did you see in the picture?" I shall answer right away: "An animal pierced by an arrow." [Cf. PI II, xi, p. 203b]

Page 82

642. "This phenomenon is at first surprising, but a physiological explanation of it will certainly be found."--
Our problem is not a causal but a conceptual one. The question is: *In what sense* is it seeing? [PI II, xi, p. 203d-e]

Page 82

643. Often I see a broken contour in a drawing as complete.

Page 82

644. I see that an animal in a picture is transfixed by an arrow. It has struck it in the throat and sticks out at the back of the neck. Imagine the picture is a silhouette.--Do you *see* the arrow--or do you merely *know* that these two bits are supposed to be part of an arrow? [PI II, xi, p. 203b]

Page 82

645. Compare Köhler's figure of the interpenetrating hexagons. [PI II, xi, p. 203b]

Page 82

646. But this is seeing! *In what respect* is it seeing? [PI II, xi, p. 203d]

Page 82

647. If the picture were shown to me just for a moment and I had to describe it, *that* would be my description; if I then had to draw it, I

Page Break 83

should certainly draw two identical interpenetrating hexagons, and in *this* respect I would not miss the mark with the copy, even if several other things were wrong in it. [PI II, xi, pp. 203f-204a]

Page 83

648. Is it knowing or seeing?--What if it were *only* knowing? In which cases would I say it is only knowing? If I read a blue-print, for example.

Page 83

649. What does it mean for me to look at a drawing in descriptive geometry and say: "I know that it continues here but I can't *see* it like that"? Does it mean a lack of familiarity in 'knowing my way about'? This familiarity is certainly one of our criteria. The criterion is a certain KIND of knowing one's way about. (Certain gestures, for instance, which indicate the three-dimensional relations. Fine shades of behaviour.) [PI II, xi, p. 203b]

Page 83

650. You need to think of the role which pictures (as opposed to working drawings) play in our life. This role is by no means something uniform. [Cf. *PI II*, xi, p. 205c]

Page 83

651. If you see the drawing as ..., what I expect from you will be pretty different from what I expect when you merely know what it is meant to be. [*PI II*, xi, p. 205d]

Page 83

652. [Remark about the *third* person.]

Page 83

653. Proverbs are sometimes hung on the wall. But not theorems of geometry. †1 Our relation to these two things. [*PI II*, xi, p. 205c]

Page 83

654. "If I see it *this* way, it fits *this*, but not *that*." This is a very specific language-game using the expression "to see something *this* way". And the criterion for 'seeing *this* way' is different here from that used in descriptive geometry.

Page 83

655. What is the criterion for his *seeing* it that way if he says, for instance, "When I see it *this* way it fits *this*"?--His ability, for example, to make, or to describe, or to suggest certain changes in the picture or building, etc., changes which would have a particular effect on someone who looked at it.

Page Break 84

Page 84

656. What if someone were to say: The plot of a dream †1 is a strange disturbance of memory; it gathers together a great number of memories from the preceding day, from days before that, even from childhood, and turns them into the memory of an event which took place while a person was sleeping.

Indeed, all of us are familiar with instances in which we blend several days' memories into *one*.

Page 84

657. For when should I call it a mere case of knowing, not seeing?--Perhaps when someone treats the picture as a working drawing, and *reads* from what it represents. (Fine shades of behaviour.) [*PI II*, xi, p. 204i]

Page 84

658. I immediately recognize the hexagons as such. Now I look at them and ask myself: "Do I really see them *as* hexagons?"--and for the whole time I am looking at them?--And I should like to reply: I am not thinking of them as hexagons the whole time. [Cf. *PI II*, xi, p. 204b]

Page 84

659. The first thing to jump to the eye in this picture is: they are hexagons. [*PI II*, xi, p. 204b]

Page 84

660. Someone tells me: "I saw it at once as two hexagons. And that's the *whole* of what I saw." But how do I understand this? I think he would have immediately answered "Two hexagons" to the question "What are you seeing?" Nor would he have treated this answer as one among many possibilities. In this his answer is like the

answer "An animal"--on being shown a picture of one; or "A face"--on being shown the figure . [*PI II*, xi, p. 204c]

Page 84

661. Immediately I *recognize* it as a face, and am prepared to treat it as one.

Page 84

662. Of course, I might also have seen the picture first as something different and then have said to myself "Oh, it's two hexagons!" But that is not what happened. So the aspect would have altered. And does this prove that I in fact saw it in a particular aspect?

(Well, as you like it!) [*PI II*, xi, p. 204f]

Page 84

663. "Is it a *genuine* visual experience?"

The question is: To what extent is it one? [*PI II*, xi, p. 204g]

Page Break 85

Page 85

664. [It is difficult to see...]

[The eye "Look how it's looking!"]

665. "To me it's an animal pierced by an arrow." That is what I treat it as, this is my *attitude* to the figure. This is one meaning in calling it a case of seeing. [*PI* II, xi, p. 205a]

666. But can I say in the same sense: "To me these are two hexagons"? Not in the same sense, but in a similar one.--[*PI* II, xi, p. 205b]

667. So in this sense I only see it *this* way as long as I have this *attitude* toward it? That could be said.

668. "This feature of the picture caught my eye."

669. The best description I can give of what was shown me for a moment is *this*: ...

"The impression was that of a standing animal." So a *perfectly definite* description came out.--Was it *seeing*, or was it a thought?

How am I to decide? [*PI* II, xi, p. 204d]

670. But do I only see the picture in this aspect so long as I have this attitude toward it?--That can be said.

671. But couldn't one also say: "I always see it as that, so long as I never see it as anything else"?

672. [Ref. 'descriptive geometry', etc.] "He sees it three-dimensionally and therefore he knows his way about in the drawing as well as if he were operating in the three-dimensional model." But isn't the particular way he works within the drawing the criterion for his seeing it three-dimensionally? (For what do I know about his impression otherwise?)

673. But I don't see it as an animal only while I am saying this.

Neither does a body weigh something only when it is being weighed. (Conceptual determination.)

674. To me it's a lion. How long is it a lion to me?

675. But wait! Do I ever really say of an ordinary picture (of a lion) that I see it as a lion? I've certainly never heard that yet.†1

676. And yet here I've been talking about this kind of seeing!

677. I could say of one of Picasso's pictures that I don't *see* it as human. Or of many another picture that for a long time I wasn't able to see what it was representing, but now I do. Isn't this similar to: for a long time I couldn't hear this as of a piece, but now I hear it that way. Before, it sounded like so many little bits, which were always stopping short--now I hear it as an organic whole. (Bruckner.)

678. Would you understand it if I were to say "We *regard* the photograph, the picture on our wall, as people and other things depicted there"? [Cf. *PI* II, xi, p. 205e]

679. This need not have been so. We could easily imagine people who did not have this relation to our pictures. (Who, for example, would be repelled by our photographs because a face without colour is sinister and ugly.) [*PI* II, xi, p. 205f]

680. We don't say "I see this as a human being" of a conventional picture of a human being. "I see it as a..." goes together with... ("Goes together" in the technique of the <language-game>.)†2

681. I say: "We regard a portrait as a human being"--but when do we do so, and for how long? Always, if we see it at all (and do not, say, see it as something *else*)?

I might say yes to this, and that would determine the concept of regarding-as.--The question would be whether yet another concept of seeing-as is also of importance to us: a concept of seeing-as which only takes place while I am actually *concerning* myself with the picture as this object. [*PI* II, xi, p. 205g]

682. The concept of noticing. I can say that I sometimes notice the similarity of this picture to..., and some such thing; but I do not

say that I sometimes notice that this photograph is a face.

I could say: A picture does not always *live* for me while I am seeing it. [b: *PI* II, xi, p. 205h]

683. But now the question is: Is this "living" a kind of "seeing", or: what right would I have to call it "seeing"? What relationship is there between this concept and other visual concepts?

684. But, of course, we don't say that we 'see' the conventional picture of, say, a lion, *as* a lion.

685. "Her picture smiles down on me from the wall." It need not always do so whenever I see it. But this expression is also a justification for the other expression that I don't always 'see it that way'. [Cf. *PI* II, xi, p. 205h]

686. In giving all these examples I am not aiming at some kind of completeness, some classification of all psychological concepts. They are only meant to enable the reader to shift for himself when he encounters conceptual difficulties. [*PI* II, xi, p. 206a]

687. A child will say "Now it's a house"--this can be said even in the game where a chest is a house, in several different ways and situations. Someone enters the room while the game is going on; he is told "Now it's a house". This does not mean: "*Now* it's become a house for me", it doesn't mean the dawning of an aspect. In order for that to happen, the tone and the situation must be of a particular kind. Here again it's a case of fine differences of behaviour.

688. 'Fine shades of behaviour.'--When my understanding of a theme is expressed by my whistling it with the correct expression this is an example of such fine shades.

But even if "Now it's a house" does not express the *dawning* of an aspect, can't it be a report of the unchanging aspect? [a: *PI* II, xi, p. 207a]

689. "He quite forgets that it is a chest; for him it actually is a house." (There are definite tokens of this.) Wouldn't it also be correct to say of such a person that he *sees* it as a house? [*PI* II, xi, p. 206f]

690. And if you know how to play this game and, given a particular situation, you exclaimed with special expression †1 "Now it's a house!" your words would be expressing the dawning of an aspect. [*PI* II, xi, p. 206g]

691. But the expression in one's voice and gestures is the same as if the object had altered and had ended by *becoming* this or that. [*PI* II, xi, p. 206i]

692. I should like to say that what dawns here lasts only as long as I am occupied with the object in a particular way. ("See, it's looking!") (Noticing a family resemblance between this face and one which isn't here now.)--'I should like to say'--and is it so?--Ask yourself "For how long am I struck by a thing?" For how long do I find it *new*? [*PI* II, xi, p. 210d]

693. Would it be correct to say of the change of aspect in the rotating drum that there is no perception that the object *stays the same*? Because one really can be in doubt there as to whether the kind of motion changed.

694. You must remember that the descriptions of the changing aspects are of a different kind in each case. [*PI* II, xi, p. 207d]

695. For the sake of brevity I shall call the aspects 'black cross', 'white cross' the principal aspects of the double cross. Likewise I shall speak of the two principal aspects of the step.

There is a fundamental difference between these, and the aspect of the triangle as an overturned triangle, for instance. †2

696. The difference is contained in the description that one uses in reporting the aspect.

697. All experiences of aspect are expressed in the form: "Now I see it as *that*" or "Now I see it *so*" or "Now it is *this*--now *that*" or "Now I hear it as ...; I heard it before as ...". But the explanation of these '*that*'s' and '*so*'s' is very different from case to case.

698. Imagination is required to see a triangle as half of a parallelogram, but not to see the principal aspects of a double cross.

Page Break 89

699. The latter seem to be of a more fundamental nature than the former.

700. You can 'see the d<uck> and r<abbit> aspects' only if you are thoroughly familiar with the shapes of those animals; the principal aspects of the double cross could express themselves in primitive reactions of a child who couldn't yet talk.

701. --Those two aspects of the double cross (I shall call them the aspects *A*) might be reported simply by pointing alternately to an isolated white and an isolated black cross.

One could quite well imagine this as a primitive reaction in a child who cannot yet talk.

Thus in reporting the aspects *A* we point to a part of the double cross.

The duck and rabbit aspects could not be described in an analogous way. [*PI* II, xi, p. 207f]

702. You only 'see the duck and rabbit aspects' if you are already conversant with the shapes of those two animals. There are no analogous conditions for seeing the aspects *A*. [*PI* II, xi, p. 207g]

703. It is possible to take the duck-rabbit for the picture of a rabbit, the double cross for the picture of a black cross, but not to take the figure for the picture of something that has fallen over. To see this aspect of the triangle demands imagination. [*PI* II, xi, p. 207h]

704. Whoever *takes* the schematic cube for a cube sees it primarily as this cube even though he can later try to see it differently, and will sometimes succeed in so doing. (Compare with the double cross.)

705. The aspects *A* are not essentially three-dimensional. A black cross on a white ground is not necessarily a black cross lying on a white surface. You could teach someone this idea without ever showing him anything but black crosses painted on paper; assuming that the surroundings of these crosses were to change and that the cross was the *important* thing in the perception: If you have it copied, for example, it will always, or nearly always, be the cross that is copied, etc.

The aspects *A* are not connected with *illusion* in the same way as

Page Break 90

are the three-dimensional aspects of the schematic cube.†1 [Cf. *PI* II, xi, p. 208a]



706. I can imagine some arbitrary ciphher--this, for instance:  to be a strictly correct letter of some foreign alphabet. Or again, as a faultily written one; and faulty in one or more of several ways: For example, it might be slap-dash, or typical childish awkwardness, or like the flourishes in a legal document. It could deviate from the correctly written letter in a variety of ways.--And I can see it in various aspects according to the fiction I surround it with. And here there is a close kinship with experiencing a meaning of an isolated word. [*PI* II, xi, p. 210c]

707. "I noticed the likeness between him and his father for maybe 5 minutes, and then no longer." One can say this if his face were changing and only looked like his father's for those 5 minutes. But it can also mean that his resemblance to his father struck me for only a few minutes, and then I forgot about it. [*PI* II, xi, p. 210f]

708. "I'm no longer struck by it"--but what happens when I am struck by it? Well, I look at the face with an expression of astonishment, not only in my mien, but maybe also in my words. But is that being struck by the likeness? No, these are the appearances of being struck; but these *are* 'what happens'. 'Being struck' is a different concept.--[Cf. *PI* II, xi, p. 211d]

Page 90

709. 'Thinking' and 'inward speech' (I do not say: "talking to oneself") are different concepts. [*PI* II, xi, p. 211f]

Page 90

710. Is being struck looking plus thinking? No. Many of our concepts *cross* here. [*PI* II, xi, p. 211e]

Page 90

711. "If you didn't *experience* the meaning of the words, then how could you laugh at puns?" [<In English> Hairdresser and sculptor.]†2--We do laugh at such puns: and to that extent we could say (for instance) that we experience their meaning.

Page Break 91

Page 91

712. Just think of the words exchanged by lovers! They're 'loaded' with feeling. And surely you can't just agree to substitute for them any other sounds you please, as you can with technical terms. Isn't this because they are *gestures*? And a gesture doesn't have to be innate; it is instilled, and yet *assimilated*.--But isn't that a myth?!--No. For the signs of assimilation are that I want to use *this* word, that I prefer to use none at all to using one that is forced on me, and similar reactions.

Page 91

713. For example, a word has come to carry a certain *tone* along with it; and I cannot, at the drop of a hat, simply utter another word with the same emotional tone.

Page 91

714. The likeness makes a striking impression on me, for example then the impression fades.

It only struck me for a few minutes, and then no longer did. [*PI* II, xi, p. 211d]

Page 91

715. What happened here? First I looked with a strange expression at the face, and if someone had asked me "Why are you looking at him with such interest?", I would have answered "Because he looks *so much* like his father". Perhaps he's talking to me, and I'm not really paying any attention to what he's saying because all the while I am thinking just about this similarity.--That is more or less what comes to my mind in response to the question what happened then.

Page 91

716. But there is a heterogeneous element in this answer: "and if someone had asked me...". For that isn't anything that 'happened' when I was struck by the similarity.--Indeed, my preoccupation is not even the same kind of thing as my facial expression.--So what is left is just my facial expressions, my gestures, and possibly the words that I say either to myself or to others.

Page 91

717. Being struck is related to thinking.

Page 91

718. What happened here?--What can I recall? My *own* facial expression comes to mind, I could reproduce it. If someone who knew me had seen my face he would have said "Something about his face struck you just now".--Words also occur to me, words which I say on such an occasion, out loud to myself. And that's all. And is this what being struck is? No. [*PI* II, xi, p. 211d]

Page Break 92

Page 92

719. To notice, to become aware of something, to turn one's attention to something.

Page 92

720. "Do you always *see* this leaf as *green* so long as you look at it, and the colour doesn't change for you?" Does this question have a clear meaning? An answer might be: "Well, I'm not saying 'Oh, how green it is!' the entire time."

Page 92

721. "Are you *conscious* of its colour the whole time?" My first reaction would be: "Certainly not!" But when and (for) how long am I conscious of it? I don't seem to be able to say much of anything about this; I don't know which criteria are to be applied here. Should I say: "Only as long as I *think* about it"?

Page 92

722. Someone tells me: "I looked at the flower, but was thinking of something else and was not conscious of its colour." Do I understand this?--I can imagine a significant context, say his going on: "Then I suddenly *saw* it, and realized it was the one which ...". [PI II, xi, p. 211b]

Page 92

723. But what about this answer: "If I had turned away then, and had been asked, I could not have said what colour it was"?

"He looked at him without seeing him." There is such a thing. But what is the criterion for it? Well, there is a variety of cases here. [PI II, xi, p. 211b]

Page 92

724. "Just now I looked at the shape rather than at the colour." Do not let such phrases confuse you. Above all, don't wonder "What can be going on in the eyes or brain here?" [PI II, xi, p. 211c]

Page 92

725. "The echo of a thought insight"--one would like to say. [PI II, xi, p. 212b]

Page 92

726. "The word has an atmosphere."--A figurative expression; but quite comprehensible in certain contexts. For example, the word "knoif" has a different atmosphere from the word "knife". †1 They have the same meaning, *in so far* as both are names for the same kind of objects.

But what is one to say here? *Do* they or *don't* they have the same meaning?

Page Break 93

Page 93

727. Should I now distinguish among so and so many kinds of meaning? I do *not* want to do that. This kind of classification could be useful for a particular practical purpose. Because for such a purpose one--out of the countless possible classifications--would be more suitable than another.

Page 93

728. A botanist classifies plants. But you don't need a system of classification to show somebody how multiform plants are and how diverse the fine distinctions among them are.

Page 93

729. I saw his face (in my mind's eye) as clearly as before--but I no longer noticed the similarity to the other one.

Page 93

730. Possibly the one similarity diminished for me and I became aware of another.

Page 93

731. Assume--as an aid to understanding--that as I look at his face, certain memories I have become more and less vivid, and that *this* is responsible for the change of aspect. Then should I still say that I *see* now one thing, now another?

Page 93

732. So is noticing a likeness seeing or isn't it? How am I to decide? Here we have dissimilar, yet related, concepts.

Page 93

733. By noticing the aspect one perceives an internal relation, and yet noticing the aspect is related to *forming an image*.

Page 93

734. It is only if someone *can do*, has learnt, is master of, such-and-such, that it makes sense to say *he* has had a certain experience. [PI II, xi, p. 209a]

Page 93

735. --So do we *see* timidity, or don't we?

The concept 'timid' can be used to describe what is visually perceived, just as the concept 'major' or 'minor' can be used to describe the melody I hear. [Cf. PI II, xi, p. 209b, c]

Page 93

736. How could I see that a facial expression was mean, frightened, brave, if I didn't know that it was an *expression*, and not the anatomy, of the animal?

But surely that only means that I cannot use *these* concepts to describe the object of sight, just because it has *more* than purely visual

Page Break 94

reference? Might I not for all that have a *purely* visual concept of, say, a frightened face? (In that case, I could use a different word.) [Cf. PI II, xi, p. 209b]

737. I must already know†1 a lot in order to describe someone's handwriting as "childish". But can I also say: "in order to *see* it as 'childish'?"

"Childish" can describe handwriting, and thus what I see, but 'childish' is not a purely visual concept.

738. Now it is correct to say: "We *could* have a purely visual concept which would be completely identical to the visual part of the concept 'vulgar' (for instance)?"

739. Such a concept would really be comparable with 'major' and 'minor', which certainly have emotional value, but can also be used purely to describe the structure of what is perceived. [PI II, xi, p. 209c]

740. So 'major' and 'minor' are compared here with 'acute-angled' and 'right-angled', for instance.

741. But wouldn't it also be correct to say that anyone who did not have our concepts of 'hesitant', 'childish', 'vulgar', could not *sense* the handwriting or the facial expression the way we do, even if he had a concept which was always applicable where 'hesitant', for example, is? So couldn't I say:†2 Both *see* the same thing, but they *sense* it differently? Just as both may hear something in a major key, but sense it differently.

742. Think of the expression "I heard a *plaintive* melody"! And now the question is: "Does he *hear* the plaint?" [PI II, xi, p. 209f]

743. And if I reply: "No, he doesn't hear it; he (merely) has a sense of it"--where does that get us? One cannot mention a sense-organ for this 'sense'.

Some would like to reply here: "Of course I hear it!"--Others: "I don't really *hear* it."--We can, however, establish differences of concept here. [PI II, xi, p. 209g]

744. (We can draw a conceptual border-line. But where does the idea of 'sensing' the vulgar, the frightening, etc., come from in the

first place?) We *react* to a hesitant facial expression differently from someone who does not recognize it as hesitant (in the *full* sense of the word).--But I do *not* want to say here that we *feel* this reaction in our muscles and joints.--No, what we have here is a modified concept of *sensation*. [PI II, xi, p. 209h]

745. But what is there here that is *sensation-like*?

746. "You must *sense* the sadness of this face." (While looking at a picture.)--

Whoever senses it often imitates the face with his own. He is impressed. The picture produces this effect in him. I could best compare this 'sensation' to the sensation of pain, which also has a characteristic expression within the repertory of facial expressions and gestures.

And yet it too is related to seeing because it (?) -- -- --

747. What is the expression, the criterion, for this sensation? Surely the way, for example, or the kind of *expression* with which someone will sing a melody he's just heard. Also, perhaps, the kind of face he has then. Or: what he will say about it. That is, the particular description he gives of it.

748. But the truth of the matter is: 'Wailing' is not a purely acoustical concept. But I can use it to describe what is purely acoustical. ("The steam whistle makes a wailing sound. ") The word "wailing" could also lose all of its non-acoustical relations and become a purely acoustical term. (As with the words <in English> "to travel" and "travailler", which were originally related to very painful things, a relation which they then lost.)

749. Now one could object to the term "*purely* acoustical".

Who says what the "purely" acoustical is?--Well, "purely acoustical" is a description that applies when you can reproduce exactly what you've heard, leaving all other relations out of it.

750. After all, I can describe a chair using the concept "style of Louis XIV", and I can contrast this with a description which takes note of the shape, colour, etc., by using drawings, etc., and does not refer to any historical period, or king, etc.

Page Break 96

Page 96

751. Suppose someone asked: "Do you *see* the style Louis XIV when you look at the chair?"

Page 96

752. It is hard to understand and to represent conceptual slopes.

Page 96

753. But we can answer the question, "What does a chair in the style of Louis XIV look like?"--or, "What does a plaintive melody sound like?"--Show me such chairs, sing me such melodies!

Page 96

754. The epithet "sad", as applied, for example, to the outline face, characterizes the grouping of lines in a circle. (Major, minor.) Applied to a human being it has a different, though related, meaning. (But this does *not* mean that a facial expression is *like* the feeling of sadness!) [PI II, xi, p. 209d]

Page 96

755. Think of this too: I can only see, not hear, red and green--but sadness I can also hear in his *voice* as much as I can see it in his face. [PI II, xi, p. 209e]

Page 96

756. Untangling many knots, that is the philosopher's task.

Page 96

757. This face is impudent, this face disgusts me, the smell is repulsive. Is repulsiveness part of the sensation of smell? How is this to be decided? One might ask, for instance: "Can two people have the *same* sensation of smell, but one of them find it repulsive, the other not?"--And what would the criterion for sameness be?--They could compare this smell with the same smells, for instance.--But here there is no accepted criterion.

So do I *see* the impudence? Yes and No. Both answers can be justified.

Page 96

758. You don't need any *knowledge* to find a smell repulsive.

Page 96

759. "Look, if you draw these lines the face turns sad." In what category does this sentence belong? How is it used? I once said that it was like a geometric proposition. But one could be of the opinion that it was a psychological, and therefore an empirical, proposition. (Comparable, for example, to: If you add these ingredients, the substance turns yellow.)

Page Break 97

Page 97

760. One might say to a child, for example, "Look, when you put these two stones together you get a circle".

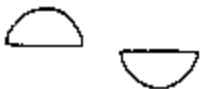

Is he learning an empirical proposition? (Here I am purposely talking about a child, not an adult.)

Page 97

761. (Couldn't the sentence again fall 'between several games'?)

Page 97

762. That proposition would not have to be a geometrical one. Its purpose could be to confirm that the face composed of *these* lines *now* gives *me* the impression of sadness. But again, it could more or less play the role of a geometrical (timeless) proposition.

Page 97

763. One might say of someone that he was blind to the *expression* of a face. Would his eyesight on that account be defective?

That is, of course, not simply a question for physiology. Here the physiological is a symbol of the logical. [PI II, xi, p. 210a]

Page 97

764. 'He has the eye of a painter', 'the ear of a musician'.

Page 97

765. Now is it simply a conceptual shift if we refer to sensing an expression as seeing, just as we speak of marrying money? Is there merely a misunderstanding here, or a gradual sloping of the concept 'see'?

766. A person who had seen only *one* facial expression couldn't have the concept 'facial expression'. 'Facial expression' exists only within a play of the features. Someone who had only seen 'sad' faces could not *sense* them as sad.

767. But surely he could *see* them just as you and I do.--But the word "sense" still isn't unobjectionable.--What do I perceive via sensation? In addition to the so-called sadness of his facial features, do I also notice his sad state of mind? Or do I *deduce* it from his face? Do I say: "His features and his behaviour were sad, so he too was probably sad"?

768. I believe this question belongs here: Does 'sad music' make us *sad*? Yes and No, it seems. We make a sad face, for instance, or at any rate a face that *reflects* sadness.

769. One sees sadness insofar as one sees a person's sad facial expression, for instance, but surely one doesn't see the sad ring of his voice.

770. Indeed, we do see weeping. Now does a person who observes only the physiological phenomenon see it differently from a person who sees an expression of grief in it?--He *observes* it differently.

771. Indeed, I am inclined to ask: Do I have so much as an *excuse* to be talking about a different kind of 'seeing' there?

772. Well, what would indicate that he sees it differently? Only his attitude toward it.
And to be sure: Whoever observes differently also sees something different.

773. Suppose someone were to ask you quite straightforwardly and in all seriousness "Why do you say he *sees* it differently?" (What could you answer?)

First of all I'd be inclined to say "He is *looking* at something different", then maybe "He will draw different comparisons". Indeed, maybe even the very fact that the person is *not* crying or wailing makes his face look sadder.

774. I hear a melody completely differently after I have become familiar with its composer's style. Previously I might have described it as happy, for example, but now I sense that it is the expression of great suffering. Now I describe it differently, group it with quite different things.

775. If you feel the gravity of a tune, what are you perceiving? Nothing that could be explained by reproducing what you heard. [*PI* II, xi, p. 210b]

776. How could I recognize a facial expression if I didn't know that it was an expression, and not the anatomy of this animal?

How could I see sadness, gravity, cruelty in the face, without knowing that?

777. Imagine a physiological explanation of this experience. Let it be this: when we look at the figure, our eyes scan it repeatedly, always following a particular path. This path corresponds to a particular periodic movement of the eyeballs. It is possible to jump

from one such pattern to another and for the two to alternate (double cross). Certain patterns of movement are physiologically impossible, hence I cannot see the duck-rabbit as the picture of the head of a rabbit superimposed on the head of a duck, nor can I see the schematic cube as the picture of two interpenetrating prisms. And so on.--Let's assume that this is the explanation.--"Yes, now I know that it is a kind of seeing." You have now introduced a *new*, a physiological criterion for seeing. And this can screen the old problem from view, but not solve it.--The purpose of this remark is to bring before your view what happens when a physiological explanation is offered. The psychological concept hangs out of reach of this explanation. And this makes the nature of the problem clearer. [*PI* II, xi, p. 212c]

778. The question now obtrudes: Could there be human beings who could not see something *as something*?--Or: What would it be like if a person lacked this capacity? What sort of consequences would it have? Would this defect be comparable, say, to colour-blindness or to not having absolute pitch? We will (for now) call it "aspect-blindness"--and will next consider what might be meant by this. (A conceptual investigation.) [PI II, xi, p. 213f]

Page 99

779. Ought he therefore to be able to see the schematic cube as a cube, for example? It would not follow from that that he could recognize it as a representation (a working drawing, for instance) of a cube. But it would not jump from one aspect to the other. Question: Could he *take* it as a cube, as we do? If not, then that will not be called *blindness*.

He will have an altogether different relationship to pictures from ours. (And *these* kinds of deviations from the norm are easy to imagine.) [PI II, xi, pp. 213g-214a, b]

Page 99

780. Is he supposed to be blind to the similarity between two faces? And so also to their identity or approximate identity? I wouldn't want to say *this*.--We would call a person who couldn't perceive the identity of shapes "feeble-minded", not "blind". [Cf. PI II, xi, p. 213f]

Page 99

781. The aspect-blind man is supposed not to see the aspects A change. But is he also supposed not to recognize that the double cross contains a black cross? So if told "Show me figures containing a black cross among these examples" will he be unable to manage it?

Page Break 100

No, but he will simply not be supposed to say: "Now it's a black cross on a white ground!" [PI II, xi, p. 213f]

Page 100

782. We say that someone has 'the eye of a painter' or 'the ear of a musician', but anyone lacking these qualities hardly suffers from a kind of blindness or deafness.

Page 100

783. We say that someone doesn't have a 'musical ear', and 'aspect-blindness' is (in a way) comparable to this sort of inability to hear. [Cf. PI II, xi, p. 214c]

Page 100

784. The importance of the concept 'aspect-blindness' lies in the kinship of seeing an aspect and experiencing the meaning of a word. For we want to ask: "What are you missing if you do not *experience* the meaning of a word?"--If you cannot utter the word 'bank' by itself, now with one meaning, then with the other, or if you do not find that when you utter a word ten times in a row it loses its meaning, as it were, and becomes a mere sound.†1 [PI II, xi, p. 214d]

Page 100

785. The report "The word... was crammed full of its meaning" is used quite differently, has quite different consequences, from "It had the meaning...".

Page 100

786. "How does the chemist know that there is an Na atom at *this* point in the structure?"

Compare: "How does Mr N. know that there is an Na atom at *this* point, etc.?"--The answer could be: "A chemist told him that."

The question "How does the chemist know..." is the typical way the question about the *criterion* is expressed.

Page 100

787. Think here of a special kind of illusion which throws light on these matters.--I go for a walk in the environs of a city with a friend. As we talk, it comes out that I am imagining the city to lie on our right. Not only do I have *no* conscious reason for this idea, but some quite simple consideration was enough to make me realize that the city lies behind us. I can at first give no answer to the question *why* I imagined the city in *this direction*. I had *no reason* to think it. But

Page Break 101

though I see *no reason* still I seem to see or surmise certain psychological causes for it. In particular, certain associations and memories. For example, we are walking along a canal, and once before I had followed a canal which lay in the direction I had imagined. I might as it were psychoanalytically investigate the causes of my conviction. [PI II, xi, p. 215d]

788. "But what is this queer experience?"--Of course, it is not queerer than any other; it simply differs in kind from those experiences which we regard as the most fundamental ones, our sense-impressions, for instance. [PI II, xi, p. 215e]

789. But how is a person who feels that the city is located in this direction to express his experience correctly? Is it correct, for example, to say that he feels it? Should he really coin a new word for it? But then how could anyone learn this word? The *primitive* expression of the experience couldn't include it. He would probably be inclined to say "I feel as if I knew that the city lay over there". Well, the very fact that he says this, or something like it, in these circumstances is itself the expression of this singular experience.

790. The name, the picture of its bearer.

791. "I feel as if I knew the city lay over there."--"I feel as if the name Schubert fitted Schubert's works and his face." [PI II, xi, p. 215f]

792. An investigation is possible in connection with mathematics which is entirely analogous to the philosophical investigation of psychology. It is just as little a *mathematical* investigation as the other is a psychological one. It will *not* contain calculations, so it is not, for example, logistic. It might deserve the name of an investigation of the "foundations of mathematics". [PI II, xiv, p. 232b]

793. I say the word "march" to myself and 'mean' it at one time as an imperative, at another as the name of a month.†1 And now say "March!", and then "March *no further!*" Are you certain that the *same* experience accompanies the word both times? [PI II, xi, p. 215g]

794. A person imagining something could express himself primitively in this way: "I feel as if I see... before me".--Now can it be said that he is calling something "seeing" which actually is not seeing, but perhaps only something like it?

795. Given the two words "fat" and "thin"--would you rather be inclined to say that Wednesday was fat and Tuesday thin, or that Tuesday was fat and Wednesday thin? (I incline to choose the former.) Now have "fat" and "thin" some different meaning here from their usual one? They have a different use. So ought I really to have used different words? Certainly not that. I want to use *these* words (with their familiar meanings) *here*. Now I say nothing about the causes of this phenomenon. They could be, for instance, that when I was a child, I was taught by a fat teacher every Wednesday, by a thin one on Tuesdays. But that is a hypothesis. Whatever the explanation--the inclination is there.†1 [PI II, xi, p. 216c]

796. If you asked him "What do you really mean here by 'fat' and 'thin'?", he could only explain it in the usual way. He could not point to Tuesday and Wednesday and use *them* to clarify what he means. [PI II, xi, p. 216d]

797. Could one speak here of a 'primary' and 'secondary' meaning of a word?--In both cases the explanation of the word is that of its primary meaning. It can only have a secondary meaning for someone if he knows its primary meaning. That is, the secondary use consists in applying the word with *this* primary use in new surroundings. [Cf. PI II, xi, p. 216e]

798. To this extent one might want to call the secondary meaning 'metaphorical'.

799. But the relationship here is not like the one between 'cutting off a piece of thread' and 'cutting off someone's speech', for here one doesn't *have* to use the figurative expression. And if you say "The vowel e is yellow", the word yellow is *not* used figuratively.

800. Only children who know about real trains are said to be playing trains. And the word trains in the expression "playing

trains" is not used figuratively, nor in a metaphorical sense.

801. If a person says he is calculating in his head, is he not really calculating, does he mean something else by calculating? You could never explain to a person what is meant by "calculating in the head" if he hadn't already been taught the concept calculating.

802. Only by using the concept of calculation (in writing or out loud) can we get someone to grasp what "calculating in the head" means. [Cf. *PI* II, xi, p. 216f]

803. I could not explain to anybody the meaning of the command to read something silently, or the report that he had read it silently, if I hadn't first taught him the concept of reading out loud. And this impossibility is a logical one.

804. Only if someone has learned to calculate, on paper or out loud, can he be made to grasp, by means of this concept, what calculating in the head is. [*PI* II, xi, p. 216f]

805. But think of the pictures which show a face from the front and in profile at the same time. One might say: "That's not what a face looks like!" But one might also say: That is a misleading picture unless you let your eye roam so that you no longer see it as *one* picture, in the normal sense of the word, but as several pictures, each of which has its own application.

806. The brain looks like a writing, inviting us to read it, and yet it isn't a writing.

Suppose humans became more intelligent the more books they owned--suppose that were a fact, but that it didn't matter at all what the books contained.

807. Is scientific progress useful to philosophy? Certainly. The realities that are discovered lighten the philosopher's task, imagining possibilities.†1

808. "When these words were spoken I saw him in my mind's eye." Isn't that an experience? And yet the fact that I saw *him* can't have been in the picture that was in my mind's eye. So was there a picture *and* a thought there? And was the picture an experience, but not the thought?

809. We '*experience*' the *expression* of thought.

810. I can't call the thought an experience, for then I would have to say that this experience, for example, accompanies speaking.

811. "But how would you know that it was he whose picture was in your mind?"--I didn't know it. I said it.

812. If I say that I experience the expression of a thought then I must also understand "expression" as including *imagined* expression.

813. The *purpose* of a sign.--"If you want him to come, wave your hand *this* way." "If you want me to stop, make *this* sign."--Then we can speak, for instance, of a 'purpose' of negation (of the word "not")?

We could do this only if every sentence in which it is used had a purpose.--Still, we could talk of (the) purposes of the word "not".

814. And one could say, for instance: "non" and "ne" generally serve the same purposes, and also: "*This* word has virtually no purpose at all. You can manage quite well without it."

815. Someone, for example, who constructs an artificial language (Esperanto, Basic English) will select its words according to certain points of view, and we could in turn consider *our own* language from these points of view.

He might say, for instance,: "I won't allow *two* words, one for "walk", and one for "stride", since for all

important purposes *one* is enough." And therefore he might also say: "'walk' and 'stride' have essentially the *same* meaning."

Page 104

816. Language can be observed from various points of view. And they are reflected in the respective concepts of 'meaning'.

Page 104

817. "While this was going on I thought of *him*." What does thinking of *him* consist in? How would what happened then be changed if instead of thinking of THIS PERSON I had thought of someone else?

In general did I have to be able to mention a 'germ' which then grew into a verbal expression? No.

Page Break 105

Page 105

818. "Who did you mean when you spoke about 'a friend?'"--"I meant...." As you were saying these words, what happened which turned them into an allusion to *this* man? Nothing happened which turned them into it. For even if I had had a picture of him in my mind while I was speaking, complete with details (or whatever you want to substitute for this picture), that wouldn't have accomplished any more than if I had looked at him when I was speaking. And looking at him is not the same as meaning him. There are *signs* which show that I meant *him*, and a glance could have been such a sign. An idea too is no more than such a sign.

Page 105

819. Compare the question "What happened when in saying this word you thought of him?" with "What happened when you suddenly knew how to go on?"

Page 105

820. Meaning is not a process which accompanies words. For no '*process*' could have the particular *consequences* of meaning. [*PI* II, xi, p. 218d]

Page 105

821. If the words "my friend" meant him, would I necessarily have to think of him as I was uttering them? What is the difference? But there is a difference between "I meant him when I said the word" and "He came to mind when I said the word".

Page 105

822. There are important accompanying phenomena of talking which are often missing when one talks without thinking. But these are not the thinking. [*PI* II, xi, p. 218e]

Page 105

823. I thought about *this* man--but certainly not about all of his aspects.

Page 105

824. The garden of this aunt of mine was in my mind. I saw part of it in my imagination, but not the fact, for example, that it belonged to this woman.

There was something like a sign there, which I then interpreted in *this way*. Or did I *read* it?

No, it isn't reading, but neither is it interpreting.

Page 105

825. "Now I know!" What went on here?--So *didn't* I know when I declared that now I knew?

You are looking at it wrong.

(What is the signal for?) [*PI* II, xi, p. 218f]

Page Break 106

Page 106

826. And could the 'knowing' be called an accompaniment of the exclamation? [*PI* II, xi, p. 218f]

Page 106

827. (The germ could have been a word or an image-picture or various other things.)

Page 106

828. "The word is on the tip of my tongue." What is going on in my consciousness? That is not the point at all. Whatever did go on was not what I meant by those words. It is of more interest what went on in my *behaviour*. What I said, which pictures I used, my facial expression.--"The word is on the tip of my tongue" is a verbal expression of what is also expressed, in a quite different way, by a particular kind of behaviour. Again, ask for the primitive reaction that is the basis of the expression. [Cf. *PI* II, xi, p. 219c]

Page 106

829. Intention is not expressed in mien, gesture, or voice, but resolve is.

Page 106

830. For many words philosophers devise an *ideal* use, which then turns out to be worthless.

Page 106

831. "I know..." usually means "I have ascertained that...". Nobody says he has ascertained that he has two hands.

Page 106

832. I know how to ascertain that I have two coins in my pocket. But I cannot ascertain that I have two hands, because I cannot doubt it.

Page 106

833. But what is the meaning of "ascertain something"? To understand this you have to run through some simple language-games with this word.--How does someone ascertain in language-game 8†1 that there are a certain number of tiles over there? How does one ascertain that $6 + 6 = 12$? Etc.

Page 106

834. We say "I know..." where there can be doubt, whereas philosophers say we know something precisely where there is no doubt, and thus where the words "I know" are superfluous as an introduction to the statement.

Page 106

835. The same thing is true here as with the syllogism "All men are

Page Break 107

mortal; Socrates is a man; etc." It is not clear how and under what circumstances this could be used.

Page 107

836. How could the visual impression of someone reading a printed page, for example, be described?

Page 107

837. "Yes, now I know what 'tringling' is." (He has perhaps had an electric shock for the first time.)--If he feels the same thing another time maybe he'll look for the same events to go with it. Tringling teaches him about the external world. Does remembering teach us in the same way that a certain event took place in the past?--Then we would have to *connect it up* with past events. (Photography and fashions.) Whereas it is really the *criterion* for the past. [Cf. *PI* II, xiii, p. 231c]

Page 107

838. And how will he know again in the future what remembering feels like? [*PI* II, xiii, p. 231c]

Page 107

839. How does he know that *this* feeling is 'remembering'? Compare "Yes, now I know what 'tringling' is" (he has perhaps had an electric shock for the first time). Does he know that it is memory because by means of it he recognizes the past? And how does he know what the *past* is? Man learns the expression of the past by remembering. [*PI* II, xiii, p. 231c]

Page 107

840. On the other hand one might speak, for example, of a feeling "Long, long ago", for there is an expression of voice and mien which goes with narratives of past times. [*PI* II, xiii, p. 231c]

Page 107

841. James is really trying to say: "What a remarkable experience! The word is not there yet, and yet in a certain sense is there, or something is there, which *cannot* grow into anything but this word."--But this is not experience at all. The words "It's on the tip of my tongue" are not the expression of an experience and James merely gives them this strange interpretation. [Cf. *PI* II, xi, p. 219d]

Page 107

842. They express an experience no more than the words "Now I've got it!"--We use them in *certain situations* and they are surrounded by behaviour of a special kind, even by some characteristic experiences. In particular they are frequently followed by *finding* the word. (Ask yourself: "What would it be like if human beings *never*

Page Break 108

found the word that was 'on the tip of their tongue?") [*PI* II, xi, p. 219e]

Page 108

843. Here, as in many related cases, there is something we might call a *germinal experience*: an image, a sensation, which *grows* little by little into a full-fledged explanation. And one feels inclined to say that it is a *logical* germ, something which had to develop the way it does out of *logical* necessity.

On a particular occasion I suddenly think of a certain person. How did it happen?--I saw a picture before me, maybe only grey hair then I said, I see N. before me (but it is still possible that many other people have that name).--But then I explain I meant *that* N. who..., etc.--Moreover, I didn't *read* the name in the mental image, and neither did I subsequently *interpret* it thus and so. For if I'm asked whether it was only later that I knew or decided

to whom the grey hair and the name N. belonged, then I shall say no, that I knew it from the beginning. But knowing is not an experience.--"I knew it from the beginning" really only means: I didn't read the name off the picture, for I didn't think "Whose hair is this?" or "Who looks like that?"--nor did I say to myself "For now, let's let the name 'N' stand for *this* person". It could be said that I became more and more explicit.

But then where does the idea of the logical germ come from? Which really means: Whence the idea that "Everything was already there from the beginning and was contained in the initial experience"? Isn't the reason for this similar to James's claim that the thought is already complete when the sentence begins? This treats the intention like an experience. [c: cf. Z 1]

Page 108

844. I advance from explanation to explanation. But I only seem to say what was there from the beginning. Of course. For "It hasn't been there from the beginning" would be wrong.

"The thought is *not* complete from the very beginning" means: I didn't find out or decide until later what I wanted to say. And *that* I do *not* want to say.

Page 108

845. To be sure, the impression that this experience is a germ results from a logical process. It does become a germ, *in a logical sense*. As a result of a logical interpretation.†1

Page 108

846. Couldn't I also say this: It is completely irrelevant that the grey hair was present in my mind first, and then the name. I could just as well have thought of the name first.

Page Break 109

Page 109

847. From the very beginning I knew who it was. "I didn't know it from the very beginning" would mean: I didn't find it out until later. And that's certainly not the way it was.

Page 109

848. When I'm writing, walking, eating, talking, gazing here and there (normally), I no more *try* to perform these actions than the face of an old friend '*strikes* me as familiar'.

But attempting, deciding, are *acts* of volition, the ways in which the will manifests itself to us; they are what we think of when we speak of the will.

Page 109

849. (Similarly, I think, it could be said: A multiplication is not an experiment, for no experiment could have the peculiar consequences of a multiplication.) [*PI* II, xi, p. 218d]†1

Page 109

850. But doesn't the word that *occurs* to you somehow 'come' in a special way? Just attend and you'll see!--Careful attention is no use to me. All I could discover with it would be what is now going on in me.

And how can I pay attention to it at all while I am philosophizing? To do this, I would have to wait until a word occurred to me (once) again. This, however, is the queer thing: it seems as though I do not have to wait on such an occasion. As if I could give myself an exhibition of it, even if it doesn't really happen to me. How?--I *act* it.--But what can I learn in this way? What do I mimic?--Gestures, faces, a tone of voice. (This remark can be applied quite generally.) [*PI* II, xi, p. 219a]

Page 109

851. -- -- -- *Interpreted* as experience, it does indeed look odd. (As does 'meaning' interpreted as the accompaniment of speech, or like - 1 interpreted as a cardinal number.)†2 [*PI* II, xi, p. 219d]

Page 109

852. Silent speech 'within' is not a half-hidden phenomenon, one that is difficult to see clearly,†3 and which we must now strive to see more clearly, saying as much about it as we know.--It is not hidden *at all*, but the concept is confusing.†4

Page Break 110

Page 110

We can call it an articulated event: for it takes place within a *stretch of time*, and can *accompany* an 'outer' event.

(The question whether movements of the larynx, etc., occur always or mostly in connection with internal speech may be of great interest, but not for us.) [a, c: *PI* II, xi, p. 220a]

Page 110

853. I should not say "speaking silently to myself", for one can speak internally without speaking to oneself.

Page 110

854. Imagine *this* game--I call it "tennis without a ball": The players move around on a tennis court just as in tennis, and they even have rackets, but no ball. Each one reacts to his partner's stroke as if, or more or less as if, a ball had caused his reaction. (Manoeuvres.) The umpire, who must have an 'eye' for the game, decides in questionable cases whether a ball has gone into the net, etc., etc. This game is obviously quite similar to tennis and yet, on the other hand, it is *fundamentally* different.

Page 110

855. But there is a difference here: Only someone who can *speak* can speak in his imagination. Because part of speaking in one's imagination is that *what* I speak silently can later be communicated.--On the other hand, tennis without a ball could (theoretically) be learned by someone who wasn't familiar with the other kind of tennis. [Cf. *PI* II, xi, p. 220b]

Page 110

856. "But speaking silently is surely a certain activity which I have to learn!" Very well; but what is 'doing' and what is 'learning' here?

Let the use of words teach you their meaning! [*PI* II, xi, p. 220c]

Page 110

857. "So I don't *really* calculate when I calculate in my head?!" After all, you yourself distinguish between calculation in the head and perceptible calculation! And you can't have the former concept if you don't have the latter, and you can only learn the former activity by learning the latter. (Their concepts are as closely related and as distantly separate as the concepts of a cardinal number and a rational number.) [*PI* II, xi, p. 220d]

Page 110

858. You could learn to calculate *in your head* to the beat of a metronome. [Cf. *PI* II, xi, p. 220b]

Page 110

859. Not every creature that can express fear, joy, or pain can *feign* them.

Page Break 111

Page 111

860. It might be like this: An eye can smile only *in a face*, but only in the entire figure can it ---

Page 111

861. It takes a very specific context for something to be an expression of pain; but the pretence of pain requires an even more far-reaching particular context. [Cf. Z 534]

Page 111

862. For pretence is a (certain) pattern within the weave of life. It is repeated in an infinite number of variations.

A dog can't pretend to be in pain, because his life is too simple for that. It doesn't have the joints necessary for such movements.

Page 111

863. But you can portray a pretender on the stage. So there is such a thing as an appearance of pretence, and it is much more complicated than the appearance of suffering, for instance. Otherwise pretence could never be exposed.

Page 111

864. It is conceivable that one might consciously do one's calculating in one's larynx, as one can calculate on one's fingers, for example. Then do you want to say that it is *deception* when they imagine they *hear* themselves speak inwardly, or again a mere trick of language? [Cf. *PI* II, xi, p. 220e]

Page 111

865. The hypothesis that certain physiological events take place when we speak silently is only of interest to us in that it points to a possible use of the report "I said silently to myself..."; namely, that of inferring the physiological process from the expression. [Cf. *PI* II, xi, p. 220f]

Page 111

866. What does a child have to learn before he can pretend?

Well, for example, the use of words like: "He thinks I'm feeling pain, but I'm not."

Page 111

867. A child discovers that when he is in pain for instance, he will get treated kindly if he screams; then he screams, so as to get treated that way. *This* is not pretence. Merely one root of pretence.

Page 111

868. A child has to learn all sorts of things before he can pretend. [Cf. *PI* II, xi, p. 229b]

Page 111

869. He has to learn a complicated pattern of behaviour before he can pretend or be sincere.

870. A dog cannot be a hypocrite; but neither is it sincere. [*PI* II, xi, p. 229b]

871. A child also leans to mimic pain. He learns the game: acting as if you were in pain.

872. "Once a child knows what pain is, naturally he knows that it can be feigned."

873. "... And one day the child *believes* something." Why is that wrong? "One day he says 'I believe...'" is right. "Today for the first time he believed something." Well, what's involved in that?--today simply was the first time *that* occurred within him.--But how did it become manifest? Well, today for the first time he said "I believe she's in pain". But that's not enough. So I must assume that in what followed he showed that he hadn't simply repeated somebody's words. In short, that his utterance was the beginning of a game, and that he was able to *continue* with it. Today, so it seemed, the game had become clear to him.

But how can a language-game suddenly become clear to a child? God only knows.--One day it starts *doing* something. An analogue might be the child learning a board game which he sees played daily.

874. He not only learns the use of the expression "to be in pain" in all of its persons, tenses, and numbers, but also in connection with negation and the verbs of opinion. For: believing, doubting, etc., that someone is in pain are the natural ways we behave toward others. (He learns "I believe he is in...", "He believes I am in...", etc., etc.--but *not* "I believe I'm in.")

(Does space have a gap there? No, it only seems to.)

875. Does the word 'pain' change its meaning in this process?

876. 'Feigning' poses no problem with the concept of pain. It makes it more complicated. (Use of money.)

877. The *uncertainty* whether someone else... is an (essential) trait of all these language-games. But this does not mean that everyone is hopelessly in doubt about what other people feel.

878. The parts of a machine are elastic, indeed, flexible. But does this mean that there really isn't any mechanism at all, since the parts of the machine function as if made of butter?

(And now think of mechanisms, say clock-works, made of materials which are far more flexible still than ours, so that the movements would be strangely irregular--would a mechanism like that have to be useless, or couldn't it actually be used?)

(And, of course, it is not because they are *practical* that we have the concepts we do. Or at most only a few of them exist for this reason.) [c: cf. Z 700]

879. Imagine that uncertainty is introduced into a game! That could happen in many different ways. Imagine this: [tennis without a ball]. If you found this game played, would you say that it wasn't a game at all? Well, compared to our games it would be of a far different sort. <In English> (It takes many kinds...)

880. That what someone else says to himself is hidden from me, unless he tells it to me, is part of the *concept* 'inner speaking'. Only "hidden" is the wrong word here; for if it is hidden from me it ought to be apparent to him, he would have to *know* it. But he does not 'know' it, even though my doubt does not exist for him. [*PI* II, xi, pp. 220g-221a]

881. "I know what I want, wish, believe, hope, see, etc., etc." (through all the psychological verbs) is either philosophers' nonsense or at any rate *not* a judgment *a priori*. [*PI* II, xi, p. 221c]

882. "I know..." may mean "I do not doubt..."--but does not mean that the words "I doubt" are *senseless*†1 here, that doubt is logically excluded. [*PI* II, xi, p. 221d]

883. One says "I know..." where one can find out. [*PI* II, xi, p. 221e]

Page 113

884. It is possible to imagine a case in which I could find out that I had two hands. Normally, however, I could *not* do so. "But all you need is to hold them up before your eyes."--If I could doubt *now* that I have two hands, then I wouldn't have any reason to believe my *eyes*. (I might just as well ask a friend.) [*PI* II, xi, p. 221f]

Page 113

885. "*His* pains are hidden from me" would be like saying "These sounds are hidden from my eyes."

Page Break 114

Page 114

886. The uncertainty in which all his behaviour leaves me as to what is in his soul. But does it always leave me uncertain?

Page 114

887. "To be sure, this uncertainty isn't always subjective, but sometimes *objective*." (But what does that mean?)

Page 114

888. 'Objective uncertainty' is an indefiniteness in the nature of the game, in the admissible evidence.

Page 114

889. "What he says inwardly is hidden from me" might, of course, also mean that I can for the most part not *guess* it, nor can I deduce it from, for example, the movements of his throat (which would be a possibility). [*PI* II, xi, p. 221b]

Page 114

890. I am, however, disregarding forms of expression such as "Only you can know what's going on inside you". †1 If you were to bring me up against the case of people's saying "But I must know whether I am in pain", "Only you can know what you are thinking", and other things, you should consider the occasion and purpose of such phrases. †1 ("War is war" is not an example of the law of identity either.) [Cf. *PI* II, xi, p. 221e]

Page 114

891. Am I less certain that this man is in pain than that $2 \times 2 = 4$? Does this show the former to be *mathematical* certainty?--'Mathematical certainty' is not a *psychological* concept. [*PI* II, xi, p. 224e]

Page 114

892. The *kind* of certainty is the kind of language-game. [*PI* II, xi, p. 224e]

Page 114

893. There are two different facts here: One, that in general I foresee my actions with greater accuracy than anyone else; the other, that my prediction is not founded on the same evidence as someone else's, and that it allows for different conclusions. [Cf. *PI* II, xi, p. 224b] †2

Page 114

894. It is not important that I *know* events in my mind, *this* is not the reason *I* am asked about my motives. The reason rather is that here the evidence for and the consequences of the statement are different sorts of things.

Page Break 115

Page 115

895. "The physicist calculates because paper and ink are more reliable than his apparatus."

Page 115

896. Let us assume there was a man who always guessed right what I was saying to myself in my thoughts. (It does not matter how he does it.)--But what is the criterion for his guessing *right*? Well, I am a truthful person and I confess that he has guessed right.--But might I not be mistaken, could my memory not deceive me? And may it not always do so anyway when--without lying--I express what I have thought within myself? -- -- -- But now it does appear that my knowing 'what went on within me' could not be the point at all. (Here I am drawing a construction-line.) [*PI* II, xi, p. 222e]

Page 115

897. The criteria for the 'truthful' confession that I thought such-and-such are not the criteria for the description of a past process. And the importance of the truthful confession does not reside in its rendering some process correctly and certainly. It resides rather in the special indications of subjective truth and in the special consequences of the truthful confession. †1 [*PI* II, xi, p. 222f]

Page 115

898. (Assuming that people's dreams can yield important information about the dreamer, what yielded the information would be truthful accounts of dreams. The question whether the dreamer's memory sometimes, often,

or always deceives him cannot even arise, unless indeed we introduce a completely new criterion for the 'correctness' of the account of a dream.) [Cf. *PI* II, xi, pp. 222g-223a]

Page 115

899. A child who learns the first primitive verbal expression for its own pain--and then begins (also) to talk about his past pains--can say one fine day: "When I get a pain the doctor comes". Now has the word "pain" changed its meaning during this learning process? Yes, its use has changed.

But doesn't the word in the primitive expression and the word in

Page Break 116

the sentence refer to the *same* thing, namely, the same feeling? To be sure; but not to the same technique.†1

Page 116

900. I can utter or write down a sentence which expresses an intention (in the first person). Let the sentence be: "In two minutes I shall raise my left arm." But still there is a difference between that really being my intention and my merely jotting it down just then as a sample sentence.

Page 116

901. After all, from a person's behaviour you can draw conclusions not only about his pain but also about his pretence.

Page 116

902. One form of guessing thoughts: One person is putting a jigsaw puzzle together, the other person can't see him, but from time to time he says: "Now he can't find something", "Now he's thinking 'I wonder where I've seen a piece like that?'" , "Now he's very happy with himself", "Now he's thinking 'Now I know how it fits!'" , "Now he's thinking 'It doesn't quite fit'" --but the first person need not be talking out loud or to himself at the time. [Cf. *PI* II, xi, p. 223b]

Page 116

903. All this is guessing at thoughts, and the fact that it does not actually happen does not make thought any more hidden than the unperceived physical proceedings. [*PI* II, xi, p. 223c]

Page 116

904. It is possible to imagine a guessing of intentions, like the guessing of thoughts, but also a guessing of what someone is actually *going to do*.

To say "He alone can *know* what he intends" is nonsense. To say "He alone can know what he will do" is wrong. For a prediction contained in the expression of intention (for example, "When it strikes five I am going home") may not come true, and I may know what he will actually do. [*PI* II, xi, pp. 223i-224a]

Page 116

905. Two things, however, are important. That in many cases he will not be able to foresee my actions where I do foresee them because of my intentions. And that the prediction that is contained in the expression of my intention has not the same foundation as another person's prediction of what I shall do, and (that) the consequences of these predictions are different.†2 [*PI* II, xi, p. 224b]

Page Break 117

Page 117

906. We should sometimes like to call belief and certainty tones, colourings, of thought: and indeed, frequently they actually are expressed in the *tone* of the voice. But do not think of them as 'feelings' which accompany our words.†1 [*PI* II, xi, p. 225b]

Page 117

907. Would it be correct to say that the language-game of stating someone's motive is the same as stating the cause, but not when the statement is made by the person who is confessing his motive?

Page 117

908. What is the difference between motive and cause?--How is the motive *discovered*, and how the cause?
[Remark about the 'methods' of measuring length.] [a: *PI* II, xi, p. 224i; b: cf. *PI* II, xi, p. 225a]

Page 117

909. We remain unconscious of the prodigious diversity of all of our everyday language-games because the outward forms of our language make everything alike. [Cf. *PI* II, xi, p. 224h]

Page 117

910. Suppose some people were discussing the weather; and one person says "The sky's yellow in the west, that's a good sign. The weather will stay good." And he acts accordingly. Someone else says "No. The sky is grey in the north. I'm convinced it will rain"--and he acts accordingly. A third person has different criteria again for his

prognosis, etc., etc. All of these people, after all, can be *certain* of themselves. And this certainty will be expressed in their actions. Indeed, instead of listing criteria at all, couldn't they have simply looked at the sky and said: "I'm under the *distinct* impression that it will ..."?

Page 117

911. Then: Several people are looking at a sick person (or someone who is acting as if he is sick); one of them has the impression that he really is sick, another the opposite impression; each one says a) he has the distinct impression that ..., and acts accordingly, b) gives reasons for this impression, but reasons which are only reasons for *him*.

"What goes on when someone has the impression...?"--Nonsense! What if people simply said: "I bet... that he is sick", "I bet... that he is pretending"?

Page 117

912. Now if I believe that someone is feigning pain then I do not just believe that he isn't feeling any. Here there is a definite *suspicion*.

Page Break 118

Page 118

I want to say: If *natural* human attitudes toward someone who is expressing pain are *various*--one cool and indifferent, another sympathetic, etc.--then *that* in itself would not mean that someone thought that the person was *pretending*.

Page 118

913. What does someone mean when he says "I think he's pretending"?--Well, he's *using a word* which is used in such-and-such situations. Sometimes he will continue the game by making conjectures about the other person's future behaviour; but that doesn't have to happen.

There's some behaviour and some conversation taking place. A few sentences back and forth; and a few actions. That might be all.

[Words have meaning only in the stream of life.]†1

Page 118

914. It strikes me like this: it's as if an empty chess-board were lying around somewhere, and next to it there were some chessmen. Then a few people drop by, and maybe one of them places two or three figures on the board and so does the other; one of them makes a move, a counter-move follows, and all the while they're making faces or saying things like "That was stupid!", "There you are!", etc. and then they stop. The whole thing would be impossible if they couldn't *play chess*; but what happens is a fragment, or a possible fragment, of a chess game.

Page 118

915. Now compare an 'expert judgment' with those judgments about the weather.

The former is of value for somebody other than the person making the judgment--the latter is only an expression of the opinion of the person who is making the judgment; to be sure, this expression may because of this have an effect on others. The language-games are different.

Page 118

916. And, of course, there are also transitions here.

Page 118

917. One could ask: "Is there such a thing as 'expert' judgment about the genuineness of expressions of feelings?" And the answer would be: Even *here*, there are what we call 'those with better' and 'those with worse judgment'. [Cf. *PI II*, xi, p. 227h]

Page Break 119

Page 119

918. But there is no such thing, for example, as a special examination on knowledge of mankind.

(What would it be like if there were?) [Cf. *PI II*, xi, p. 227h]

Page 119

919. But how does it get shown that someone's judgment is correct? That's *difficult* to say. I could cite several things; but they would only be bits and pieces of a description.

Page 119

920. One can also convince somebody that another person is in such-and-such a mental state by *evidence*.†1

And yet there is no special study here. [Cf. *PI II*, xi, p. 228b]

Page 119

921. How about this: you can set up *certain* rules, but only a few, which are of such a kind that a person usually

learns them through experience anyway--but what if what is left, the most important part, is *imponderable*??

Page 119

922. What does "imponderable evidence" mean? (Let's be honest!) [Cf. *PI* II, xi, p. 228c, d]

Page 119

923. I tell someone that I have reasons for this claim or proofs for it, but that they are 'imponderable'.

Well, *for instance*, I have seen the look which one person has given another. I say "If you had seen it you would have said the same thing". [But here there is still some unclarity.] Some other time perhaps, I might get him to see this look, and then he will be convinced. That would be *one* possibility.

To some extent I do predict behaviour ("They'll get married, she'll see to that"), and to some extent I don't.

Page 119

924. The question is: What does imponderable evidence *accomplish*? What entitles one to call it "evidence"?

(Compare the case of the weather forecaster with that of someone who is judging whether another person is suffering.) [Cf. *PI* II, xi, p. 228c]

Page 119

925. An important fact here is that we learn certain things only through long experience and not from a course in school. How, for instance, does one develop the eye of a connoisseur? Someone says, for example: "This picture was not painted by such-and-such a master"--the statement he makes is thus not an aesthetic judgment,

Page Break 120

but one that can be proved by documentation. He may not be able to give good reasons for his verdict.--How did he learn it? Could someone have taught him? Quite.--Not in the *same* way as one learns to calculate. A great deal of *experience* was necessary. That is, the learner probably had to look at and compare a large number of pictures by various masters again and again. In doing this he could have been given *hints*. Well, that was the process of *learning*. But then he looked at a picture and made a judgment about it. In most cases he was able to list reasons for his judgment, but generally it wasn't *they* that were convincing.

Page 120

926. Look at *learning*--and the *result* of learning.

Page 120

927. A *connoisseur* couldn't make himself understood to a jury, for instance. That is, they would understand his statement, but not his reasons. He can give intimations to another connoisseur, and the latter will understand them.

Page 120

928. But am I trying to say some such thing as that the certainty of mathematics is based on the reliability of ink and paper? *No*. (That would be a vicious circle.)--I have not said *why* mathematicians do not quarrel, but only *that* they do not. [*PI* II, xi, p. 226b]

Page 120

929. It is no doubt true that you could not calculate with certain sorts of paper and ink, if, that is, they were subject to certain queer changes, but still the fact that they changed could in turn only be got from memory and comparison with other means of calculation. And surely these in turn cannot be tested against something else.†1 [*PI* II, xi, p. 226c]

Page 120

930. Does it make sense to say that people generally agree in their judgments of colour?? What would it be like for them not to? One person would say a flower was red, which another took to be blue, etc.--But what right should we have to call these people's words "red" and "blue" *our* colour-words? Why should we say that they have the same meaning? We can say the one thing or the other.

Now the concept is changed and there are reasons for still calling it the same, as well as reason not to. [Cf. *PI* II, xi, p. 226e]

Page Break 121

Page 121

931. But what about this: "Generally people don't argue about their colour-judgments"? There is such a thing as 'colour-blindness' and there are ways of determining it.

Isn't that a sentence about the *concept* of colour-judgment? [Cf. *PI* II, xi, p. 227d]

Page 121

932. If there were no agreement in colour-judgments, how would human beings even learn to use the words for colours? What right should we have to call the usage they learn that of 'colour names'?

But, of course, there are transitions here.

Page 121

933. And this consideration must apply to mathematics. If our mathematical certainty did not exist, then neither would human beings be learning the same technique which we learn. It would be more or less different from ours, up to the point of unrecognizability in borderline cases. [*PI* II, xi, p. 226f]

Page 121

934. "But mathematical truth is independent of whether human beings know it or not!"--Certainly: "Human beings believe that $2 \times 2 = 4$ " and " $2 \times 2 = 4$ " do not mean the same thing. The latter is a mathematical proposition; the other, if it makes sense at all, may perhaps mean: human beings have arrived at the mathematical proposition. The two propositions have entirely different *uses*.--But what would *this* mean: "Even if everybody believed that $2 \times 2 = 5$ it would still be 4!"?--For what would it be like for everybody to believe that? Well, I could imagine that there was a different calculus. Would it be *wrong*? Is a coronation *wrong*? Useless at most. And maybe not even that. [*PI* II, xi, pp. 226g-227a]

Page 121

935. Of course, in one sense mathematics is a branch of knowledge, but still it is also an activity. And a 'false move' can only exist as the exception; for if what we now call by that name became the rule the game in which it was a false move would cease. [*PI* II, xi, p. 227b]

Page 121

936. 'Imponderable evidence' includes subtleties of tone, of glance, of gesture.

Isn't it really as if here one were looking at the workings of the nervous system? For I would very much like my feigned gesture to be exactly like the real one, but *in spite of everything* it is not the same. [a: *PI* II, xi, p. 228d]

Page Break 122

Page 122

937. I can recognize a genuine loving look, distinguish it from a pretended one. And yet there is no way in which I can describe it to someone else. If we had a great painter here, he might conceivably represent a genuine and a simulated look in pictures, or this kind of a representation could be imagined in a film, and perhaps a verbal description based on it. [Cf. *PI* II, xi, p. 228d]

Page 122

938. Ask yourself: How does a man learn to get a 'nose' for something? And how can this nose be used? [*PI* II, xi, p. 228e]

Page 122

939. What right do we have to say that a child has to learn some things before it can pretend? (... before it can make a mistake in calculating.)

Page 122

940. Someone says of his child "Today he pretended for the first time". That is quite imaginable. But not the statement "Today he was sincere for the first time"--although it can't be said of a newborn that it is sincere. And yet one *can* say "My child is already definitely sincere".

Page 122

941. So if you ask "What does a child have to learn *to be able* to be sincere?" your answer may be something like: "It must have realized that insincerity is bad"--or perhaps an answer that describes the inner life of the child, the inner requisites.

Page 122

942. Neither is the newborn child capable of being malicious, friendly, or thankful. Thankfulness is only possible if there is already a complicated pattern of behaviour.

If a figure consists of only three straight lines it can be neither a regular nor an irregular hexagon.

Page 122

943. Of course, normally only those who can talk are called sincere. And, although it does not follow from this that the concept 'sincere' is *inapplicable* where there is no speech, still this concept cannot be applied there without some difficulty.

Page 122

944. To be sure, an adult can pretend or he can be sincere without saying a word, but by using facial expressions, gestures and inarticulate sounds.

Page Break 123

Page 123

945. Imagine a newborn child who, of course, couldn't speak, but who had the play of features and gestures of an

adult!

Page 123

946. Feigning and its opposite exist only when there is a complicated *play of expressions*. (Just as false or correct moves exist only *in a game*.)

Page 123

947. And if the play of *expression* develops, then indeed I can say that a soul, something *inner*, is developing. But now the inner is†1 no longer the cause of the expression.†2 (No more than mathematical thinking produces calculations, or is the impetus behind them. And this is a remark about concepts.)

Page 123

948. Only in a quite particular musical context is there such a thing as three-part counterpoint. [C & V, p. 82]

Page 123

949. Suppose someone were to hide his intention by hiding a written plan.

Page 123

950. 'Pain is what is important--the complaining is unimportant.'--Well, I want him to take notice of my pain, not of my plaintive cries. And how does he take notice of my pain?

Page 123

951. It looks like this: there is something inner here which can be inferred only inconclusively from the outer. It is a picture and it is obvious what justifies this picture. The apparent certainty of the first person, the uncertainty of the third.

Page 123

952. There is no clear border separating sufficient from insufficient evidence. And yet there is evidence here.

Page 123

953. Our judgment of the cases *fluctuates*, just like our natural attitude toward other people.

Page 123

954. Tender expression in music. It isn't to be characterized in terms of degrees of loudness or tempo. Any more than a tender facial expression can be described in terms of the distribution of matter in space. As a matter of fact it can't even be explained by reference to a paradigm, since there are countless ways in which the same piece may be played with genuine expression. [C&V, p. 82]

Page Break 124

Page 124

955. And what would the opposite look like?--One might be able to determine sadness, for instance, with the same certainty as, say, a sore throat.--But what sort of concept of sadness would that be? Ours?

Page 124

956. Why not? If a person makes *this* face on a certain occasion, carries himself *this* way, etc., then we can predict with certainty all that we should expect (in the world as it now is) of a truly sad person.

Page 124

957. Of what does our uncertainty about the mental conditions and processes in another person consist? For it is composed of several things.†1 We cannot read off what he is saying to himself from anything external. Often we cannot understand what he says. We cannot guess his intentions. Often we don't know what kind of mood he's in.

The ignorances are of different *kinds*; and if one imagines them removed then they would be removed in different *ways*.

Page 124

958. What does it mean, for example, to know someone else's mood with certainty?

Well one might imagine that it could be read in my face.--But could intention also be read in my face?! Then why not just as well in my hands or clothes?--But one might imagine a way of finding out intention. You ask someone about his intentions and you can recognize with certainty when he is lying, and perhaps also what is going through his mind at that moment. But what if at this moment the intention were present merely as a disposition, so to speak? What if it weren't thought out?--So here it might be necessary that I have *already* observed him!

Page 124

959. "The inner is hidden from me"--isn't that just as vague as the concept of the 'inner'?

(For just consider: the inner after all is sensations + thoughts + images + mood + intention, and so on.)

Page 124

960. Clearly you don't *guess* a person's intention, his sensations, his thoughts, his mood, all in the same way.

961. Neither do I know his actions beforehand as I do my own, and I have different ways of forming my intentions than he has of guessing them.

Even when I have no positive intention, I can still have negative ones; I don't know what I'll do, but I have already decided that I *don't* want to do this or that.

962. It is a strange kind of remembering when in broad daylight you remember one of last night's dreams which you never thought of earlier on waking. -- -- --

963. The opposite of my uncertainty as to what is going on inside him is not *his* certainty. For I *can* be sure of someone else's feelings, but that doesn't make them mine.

964. "I can only guess at someone else's feelings"--does that really make sense when you see him badly wounded, for instance, and in dreadful pain?

965. Is a dream a hallucination?--The memory of a dream is like the memory of a hallucination, or rather: like the memory of a real experience. This means that sometimes you would like to say: "I just saw this and that", as if you really had just seen it.

966. As an example think of the description of '*occasions*'. Is it really clear that one has to understand the description of an '*occasion of grief*'? For the occasions of grief are interwoven with 1000 other patterns. Is it clear that someone must be able to learn the technique of designating this kind of pattern? That he be able to pick an occasion of grief out of the other patterns the way we do?

967. But here there are simple and more complicated cases; and that is important for the concept. Somebody gets burned and cries out; only in very rare circumstances would his behaviour be called "pretence". Indeed, here a doctor could tell us this and that circumstance under which it could be pretence.

968. The description of word-usage. The word is uttered--in what context? So we have to find something *characteristic* of these separate occurrences, a *kind* of regularity.--But we don't *learn* to use words with the help of rules. How could I give someone a rule for those instances in which he is supposed to say he's in pain!--On the other

hand, there is a ROUGH regularity in the use to which a person actually puts words.

969. So I shall say: It is not established from the outset that there is such a thing as '*a general* description of the use of a word'.

And even if there is such a thing, then it has not been determined how *specific* such a description has to be.

970. In what circumstances (*outer* circumstances) is something called an expression of pain? (For that after all is an important question--even if you say that something *inner* corresponds to a true expression of pain.)

971. And now can I describe these circumstances?--and why not? I could give examples, that much is clear. How can I learn to describe the circumstances? Was I taught? Or what would I have to observe to be able to do that?

972. And the same thing goes for the outward signs of 'pretence'.

973. And if I now imagine a list of such circumstances, who would be interested in it?--To be sure, individual aperçus are interesting. But would a listing which *strove* for inclusiveness be interesting? Would it be of practical use?--This game doesn't work that way at all.

974. Nothing is hidden here; and if I were to assume that there is something hidden the knowledge of this hidden thing would be of no interest.

But I can hide my thoughts from someone by hiding my diary. And in this case I'm hiding something that might interest him.

975. To say that my thoughts are inaccessible to him because they take place within my mind is a pleonasm.

976. What I say to myself silently he doesn't know: but again this isn't a matter of a 'mental process', although there may be a physical process taking place here which might do instead of words spoken out loud if the other did know it. So also a physical process here might be called 'hidden'.

977. "What I think silently to myself is hidden from him" can only mean that he cannot guess it, for this or that reason; but it does not mean that he cannot perceive it because it is in my soul.

978. You look at a face and say "I wonder what's going on behind that face?" But you don't have to say that. The external does not have to be seen as a façade behind which the mental powers are at work.†1

979. The idea of the human soul, which one either sees or doesn't see, is very similar to the idea of the meaning of a word, which stands next to the word, whether as a process or an object.

FOOTNOTES

†1 Several variants in the MS.--In the margin is added: "What is a complaint, anyway?"

†1 Var.: "notation".

†2 Var.: "But the question now remains why, in connection with that *game* of meaning we also speak of an '*act of meaning*'. This is a different kind of question from what you think.--It is (precisely) the phenomenon of this language-game that in *this* situation we say that we meant the word in *this way*, and take this expression over from another language-game. *A question has to have gone before.*

That is an alien kind of question. That is an inappropriate question; of a different racial origin, as it were."

†1 Var.: "speaks".

†2 In the margin: "It is as if, in a work of pure mathematics, there were put a question of physics as the one you were trying to ask."

†3 The German word *Bank* means "money bank" and "bench". (*Tr.*)

†1 Preceding this remark, in square brackets: "Ref. the sentence at the top of p. 82r." This refers to the end of remark 56.

†2 Preceding this paragraph in the MS, in square brackets: "Ref. Tscr. p. 667 below".--This refers to p. 667 of TS 232 and to its continuation on the following page. See *Remarks on the Philosophy of Psychology (RPP) II*, §246.

†3 Preceding the paragraph, in square brackets: "From T.S. p. 667v".--See the previous footnote.

†1 At the end of the remark in square brackets: "Continuation lost".

†1 Var.: "when the dust has settled".

†2 Preceding the remark, in square brackets: "From p. 82v, bottom". This refers to remark 56.

†1 Several variants in the MS. Following the remark, in square brackets: "Still not right."

†2 Preceding the remark in the MS, in square brackets: "Ref. Tscr. p. 670".--See *RPP II*, §256.

†3 Preceding the remark, in square brackets: "Gassy".

Page 18

†1 Reference to Schiller's *Wallenstein*.

Page 20

†1 Several variants in the MS.

Page 21

†1 Preceding the remark, in square brackets: "Ref. Tscr. p. 708/4". See RPP II, §403.

Page 27

†1 Preceding the remark, in square brackets: "Ref. Tscr. p. 740". --This refers to RPP II, § 556.

Page 28

†1 Var.: "even though not for error."

Page 28

†2 Before the remark, in square brackets: "Ref. p. 742 Tscr."--See RPP II, §§566-569.

Page 29

†1 Preceding the remark, in square brackets: "Ref. Tscr. p. 750". See RPP II, §§605-608.

Page 30

†1 Wittgenstein repeats this remark in almost the same words on the same page of the MS. The end of the variant runs: "But they had to receive a new kind of training for the use of our words. This (training) was similar to but not the same as the previous training."

Page 30

†2 This remark is obviously an "improved" variant of a remark on the previous page of the MS that seems to be partially crossed out. This remark runs: "And how could they remain unaware of the difference, if sometimes they would complain when they were in pain and sometimes when they were not? But did the difference have to be as important for them as it is for us? (Many people tell fabricated stories at a party, and the others know they are fabricated, but they buy them, just as they do true stories. They ignore the difference.)"

Page 30

†3 Before the remark, in square brackets: "Ref. Tscr. p. 759". See RPP II, §§ 648-653.

Page 31

†1 Before the remark, in square brackets: "Ref. Tscr. p. 760". See RPP II, §658.

Page 34

†1 On the same and subsequent pages of the MS, there is the following variation of the end of the remark: "But the philosophical question whether someone else feels pain is of a completely different nature; not the doubt applied in a certain case to *each*; therefore it must have a different logic."

Page 36

†1 Before the remark: "Tscr. p. 751". See RPP II, §§609-612.

Page 37

†1 Before the remark, in square brackets: "From the previous page". See remark 253.

Page 41

†1 Cf. *Remarks on the Foundations of Mathematics*, 3rd ed., Part I, Appendix I.

Page 42

†1 Var.: "primitive need".

Page 43

†1 Var.: "And yet there is something right about this 'disintegration of the sense'. You get it in the following example: You might instruct someone thus: If you want to pronounce the salutation "Hail!" expressively, you must not think of hailstones as you say it!"

Page 43

The German words are *Ei*, "egg" and the interjection *ei, ei*, "fancy that!" (*Tr.*)

Page 45

†1 Var.: "Now a picture is strongly suggested to us: that of something incorporeal which we feel, of the liveness of a face. One must remind oneself that a face with a soulful expression can be *painted* to make us believe that colours and forms alone can (also) have this kind of effect on us."

Page 46

†1 Var.: ", or that a verb designates *one* action in the first person and another in the second?"

Page 47

†1 See *PI* I, § 2.

Page 49

†1 Var.: "But need there be any question for them whether the groaning is really genuine, is really the

expression of anything? Can't they, for example, draw the conclusion... without suppressing a middle term? Isn't the point the job they give the description of behaviour?"

Page 49

†2 Var.: "And doubt may be entirely lacking. Doubting has an end."

Page 50

†1 Var.: "That is, the phenomena of hope are modes of this very complicated pattern."

Page 54

†1 i.e. the kinaesthetic feeling.

Page 56

†1 Cf. *PI* I, § 48.

Page 58

†1 Var.: "experiential concepts".

Page 59

†1 Several variants in the MS.

Page 62

†1 Var.: "static".

Page 64

†1 In the MS. Wittgenstein has "out", perhaps as a mistake. Possibly he meant "Do we also learn...".

Page 65

†1 Var.: "This has the form of a report of a new perception."

Page 66

†1 Var.: "If I know that the schematic cube has various aspects, and I want to find out what someone else sees, I can get him to make a model of what he sees, in addition to a copy, or point to such a model; even though *he* has no idea what is the purpose of this dual demonstration."

Page 69

†1 Var.: "I forgot it."

Page 70

†1 Unclear passage in the MS.

Page 72

†1 Var.: "the dawning of an aspect".

Page 72

†2 Var.: "half visual experience, half thought."

Page 74

†1 Var.: "--is this a special sort of seeing? Or is it a case of both seeing and thinking? Or an amalgam of the two--as I should almost like to say?--The question is: *Why* does one want to say this? Well, if the question is phrased in *this* way it isn't that hard to answer."

Page 74

†2 Var.; Before the paragraph, in square brackets: "Not a good continuation."

Page 75

†1 Var.: "phrases it and helps to form the impression, so to speak."

Page 79

†1 Var.: "what I feel there?--"

Page 80

†1 At the end of the remark, in square brackets: "To the previous page." Cf. remarks 619-621.

Page 81

†1 Var.: "treatises".

Page 83

†1 Var.: "mechanics".

Page 84

†1 Var.: "illusion in a dream".

Page 86

†1 At the end of the remark, in square brackets: "The remark on p. 733 Tscr. relates remark to this." See *RPP* II, §§515-522.

Page 86

†2 Following the words "goes together with..." in square brackets: "p. 733 Tscr." See *RPP* II, §517.

Page 88

†1 Var.: "with a special gesture".

Page 88

†2 This remark is the first in Volume "S" (MS 138).

Page 90

†1 Var.: "of the step."

Page 90

†2 The English joke: "What is the difference between a hairdresser and a sculptor? A hairdresser curls up and dyes, and a sculptor makes faces and busts."

Page 92

†1 In German the word used is *Säbel*, "sabre". (*Tr.*)

Page 94

†1 Var.: "have seen".

Page 94

†2 Var.: "So should I say:"

Page 100

†1 Var.: "-- -- -- What would you be missing, for instance, if you did not understand the meaning of: "Say the word 'bank' and mean it as the bank of a river"--or: "Say the word 'till' and mean it as a verb, not as a conjunction"--or if you did not find that a word lost its meaning and became a mere sound if it was repeated ten times over."

Page 100

The German word is *sondern*, meaning both "but" and "to separate". (*Tr.*)

Page 101

†1 The German word is *weiche*, meaning both "soft" and "to retreat". (*Tr.*)

Page 102

†1 Preceding the remark, in square brackets: "Ref. MS "R" p. 83". See remark 69.

Page 103

†1 Var.: "Realities are so many possibilities for the philosopher."

Page 106

†1 See *PI I*, §8.

Page 108

†1 Var.: "As a result of a grammatical explanation."

Page 109

†1 Before the remark, in square brackets: "Ref. p. 15v/3".--This apparently refers to remark 825.

Page 109

†2 Var.: "(As does intention, when it is interpreted as the accompaniment of action," ...).

Page 109

†3 Several variants in the MS.

Page 109

†4 Var.: "but the concept may easily confuse us, for it runs over a long stretch cheek by jowl with the concept of an 'outward' process, and yet does not coincide with it. (Tennis without a ball.)"

Page 113

†1 Several variants in the MS.

Page 114

†1 Alternatives.

Page 114

†2 At the end of the remark, in square brackets: "Ref. MS "R" p. 96". See remark 183.

Page 115

†1 Var.: "The criteria for the truth of a *confession* that I thought such-and-such are not the criteria for a true *description* of a process. And the importance of the true confession does not reside in its being a correct and (absolutely) certain report of a process. It resides rather in the special consequences which can be drawn from a confession whose truth is guaranteed by the special criteria of truthfulness."

Page 116

†1 At the end of the remark, in square brackets: "Ref. the §: "I'm not certain..."."

Page 116

†2 Var.: "And that the prescience inherent in my intention does not rest on the same foundation as the other person's prediction of my actions."

Page 117

†1 Var.: "Ask not "What goes on in us when we are certain that...?"--but: How is certainty manifested in our

actions?"

Page 118

†1 Cf. Norman Malcolm, *Ludwig Wittgenstein, A Memoir*, p. 93.--In MS 169, p. 47v, Wittgenstein says: "Also what goes on in the inner has meaning only in the stream of life."

Page 119

†1 Var.: "One can also convince someone that he was wrong about a person's mental state by giving him *evidence*. One can set him straight with evidence."

Page 120

†1 Var.: "And how are *these* supposed to be tested in their turn?"

Page 123

†1 Var.: "appears here ... as".

Page 123

†2 Var.: "as the prime mover of the expression."

Page 124

†1 Var.: "Our 'ignorance' about what goes on in someone else is not a *single* ignorance, but consists of different kinds of ignorance."

Page 127

†1 Var.: "But you don't have to think that way. And if someone talks to me quite obviously holding nothing back then I'm not even tempted to think that way."

LAST WRITINGS ON THE PHILOSOPHY OF PSYCHOLOGY: *Volume II*

Page Break ii

Page Break iii

Title Page

Page iii

Ludwig Wittgenstein LAST WRITINGS ON THE PHILOSOPHY OF PSYCHOLOGY

VOLUME II

The Inner and the Outer
1949-1951

Edited by
G.H. VON WRIGHT

and

HEIKKI NYMAN

Translated by

C. G. LUCKHARDT

and

MAXIMILIAN A. E. AUE

<image>

Page Break iv

Copyright Page

Page iv

Copyright © The Trustees of the Wittgenstein Estate 1992

First published 1992

First published in paperback 1993

Reprinted 1994, 1999

Blackwell Publishers Ltd

108 Cowley Road
Oxford OX4 1JF
UK

Blackwell Publishers Inc.
350 Main Street
Malden, Massachusetts 02148
USA

All rights reserved. Except for the quotation of short passages for the purposes of criticism and review, no part of this publication may be reproduced, stored in a retrieval system, or transmitted, in any form or by any means, electronic, mechanical, photocopying, recording or otherwise, without the prior permission of the publisher.

Except in the United States of America, this book is sold subject to the condition that it shall not, by way of trade or otherwise, be lent, resold, hired out, or otherwise circulated without the publisher's prior consent in any form of binding or cover other than that in which it is published and without a similar condition including this condition being imposed on the subsequent purchaser.

British Library Cataloguing in Publication Data
A CIP catalogue record for this book is available from the British Library.

Library of Congress Cataloging-in-Publication Data
Wittgenstein, Ludwig, 1889-1951
Last writings on the philosophy of psychology.

Title on added t.p.: Letzte Schriften über die Philosophie der Psychologie.
English and German.

Vol. 2. published: Oxford, UK; Malden, Mass., USA;

B. Blackwell, 1992.

Contents: v. 1. Preliminary studies for part II of the Philosophical
Investigations--v.2. The inner and the outer, 1949-1951.

I. Psychology--Philosophy. I. Wright, G. H. von (Georg Henrik), 1916- II. Nyman, Heikki. III. Wittgenstein,
Ludwick, 1889-1951. Philosophische Untersuchungen.

BF38.W764 1982 192 82-42549

ISBN 0-631-18956-4 (pbk.)

Typeset in 11 on 13 pt Bembo

By Photographics, Honiton, Devon

Printed and bound in Great Britain by MPG Books Ltd, Bodmin, Cornwall

This book is printed on acid-free paper

Page Break v

Table of Contents

Page v

CONTENTS

Editors' Preface	vi
MS 169	1
MS 170	50
MS 171	54
MS 173	60
MS 174	80
MS 176	91
Index	102

Page Break vi

Editors' Preface

Thematically, Wittgenstein's philosophical writings from the last two years of his life (1949-51) can be divided into three parts. The largest of these three parts deals with the concepts of certainty, knowing, doubting, and other topics in epistemology. A second part deals with the philosophy of colour concepts; a third, with psychological concepts and in particular with the problem of the relationship between "the inner" and "the outer", between the so-called mental states and bodily behaviour.

Most of the writings of the first group have appeared in print under the title *On Certainty*, those of the second under the title *Remarks on Colour*. The remarks on the "inner-outer" problem are closely connected with the body of ideas of the second part of the *Philosophical Investigations* and with the preliminary studies for it in the manuscripts and typescripts from the years 1946-49. But they also connect with the remarks on epistemology and colour concepts and sometimes cannot be sharply separated from them. (A longer part from MS 173, which is printed here, was already published in the *Remarks on Colour* (III, sect. 296-350).)

Wittgenstein's writings from the last years of his life are entered into eight small notebooks, and in a small bundle of loose sheets (MS 172). The most voluminous notebook is MS 173. The second largest of these notebooks, MS 169, was probably already begun in late fall, 1948, or in the spring of 1949. The content of the first half of this notebook is of the nature of preliminary studies for what is published as Volume I of these *Last Writings*, and comes from the large

manuscript books 137 and 138. The style of the remarks is terse; the sentences are frequently indicated only in abbreviated form. There are many parts which because of their unclarity are very hard to read. The second half of these writings, which begins with a discussion of the concept of dissimulation, is worked out better stylistically and in terms of content is connected to the rest of this volume. However, there is no clear border separating the two parts from each other. Therefore we considered it proper to publish this notebook here in its entirety.

The small notebooks 170 and 171 are also presented in their entirety. Chronologically they are probably closely connected to MS 169 and probably were written in the year 1949.

The voluminous notebook 173, from the spring of 1950, deals mainly with colour concepts; but it does contain two longer portions belonging to the problems of the "inner-outer".

Later, in the spring of 1950, in MS 174, Wittgenstein continued the exposition of the "inner-outer" problem of MS 173, and then returned once more to this topic in MS 176 two weeks before his death in April 1951. The excellent quality of these last writings should be obvious to every reader.

With the exception of a very few remarks (which are of a general nature) and of remarks which have already appeared elsewhere in print, we have not omitted anything of what Wittgenstein wrote in these last notebooks from the years 1949-51.

Words in angle brackets < > and references to the printed works of Wittgenstein in square brackets (including the first volume of these *Last Writings*) are those of the editors. All footnotes are also additions by the editors. The letters 'N.R.' in the upper right corner of some pages indicate that the page begins with a *new remark* (and not with a paragraph belonging to the last remark on the preceding page).

We thank Mr Joseph Braun, Mr Michael Kober, Dr Joachim Schulte for their generous help in the interpretation of difficult parts of the manuscript and the translators, Professor C. G. Luckhardt and Professor Maximilian Aue, for valuable advice and for preparing the Index. We also thank Mr Erkki Kilpinen, who helped in the preparation of the final version of the text.

Helsinki 1982, 1991

Georg Henrik von Wright
Heikki Nyman

MS 169

Page 1

(around 1949)

Page Break 2

Page 2

non & ne†1---They have the same purpose, the same use--with *one* qualification. [LW I, 384]

Page 2

So are there essential and non-essential differences among the uses? This distinction does not appear until we begin to talk about the *purpose* of a word. [LW I, 385]

Page 2

--- We might think it strange. "He doesn't play our game at all" one would like to say. Or even that this is a different type of man. [Cf. *PI II*, vi, p. 182b]

Page 2

The psychologist reports the utterances of the subject. But these utterances "I see...", "I hear...", "I feel" etc., are not about behaviour. [Cf. *PI II*, v, p. 179b]

Page 2

--- About both, not side-by-side, however, but about the one *via* the other. [Cf. *PI II*, v, p. 179c]

Page 2

But†2 this would make us see too that it would have no consequences for understanding and using the words.

Page 2

But wasn't he able to master the use of "if" and "that" just as we are? Wouldn't he understand and mean these words as we do? [Cf. *PI II*, vi, p. 182b]

Page 2

Wouldn't I think (of him) that he understood the words "that" and "if" as we do if he uses them exactly as we do? [*PI II*, vi, p. 182b]

Page 2

And if he used "that" and "if" exactly as we do, wouldn't we think he understood them as we do? [*PI II*, vi, p. 182b]

Page 2

Page Break 3

Page 3

It's another kind of man. But of what importance is that? [Cf. *PI II*, vi, p. 182b]

Page 3

It would be like someone who instead of associating a separate colour with each vowel associated one colour with a, e, i, and another with o and u. "In that case we'd have a different type of man", I would like to say. [Cf. *LW I*, 362]

Page 3

--- Because only this world (has) this sound, this tone, this grammar.†1

Page 3

So does the word "Beethoven" have a Beethoven-feeling?

Page 3

It is a look, with which *this* word looks at me. [Cf. *LW I*, 366]

Page 3

But one cannot separate the look from the face.

Page 3

--- with a quite particular expression. [Cf. *LW I*, 380]

Page 3

This expression is not something that can be separated from the passage. (Not necessarily.) It is a different concept. (A different game.) [*PI II*, vi, p. 183a]

Page 3

"Now you played the passage with a different expression."--"--now with the same" and it can also be characterized by a word, a gesture, a simile; nevertheless by *this* expression we don't mean something that can appear in a different connection.

Page 3

The experience is this passage played like this (that is, as I am doing it, for instance; a description could only *hint* at it). [*PI* II, vi, p. 183b]

Page 3

Gay colours.

Page Break 4

The 'atmosphere' is precisely that which one cannot imagine as being absent. [Cf. *PI* II, vi, p. 183c]

Page 4

The name Schubert, shadowed around by the gestures of his face, of his works.--So there is an atmosphere after all? But one cannot think of it as separate from him. [Cf. *LW* I, 69; *PI* II, xi, p. 215f]

Page 4

The name S is surrounded *in that manner*, at least if we are talking about the composer.

Page 4

But these surroundings seem to be fused with the name itself, with this word.

Page 4

--- Imagine I hear that someone is painting a picture--[Cf. *PI* II, vi, p. 183d]

Page 4

: I hear that someone is painting a picture "... ". [Cf. *PI* II, vi, p. 183d]

Page 4

--- if they did not fit in with this passage.

Page 4

--- would be totally addle-brained and ridiculous.

would be completely repulsive and ridiculous.

would be completely ridiculous and repulsive.†1

Page 4

My k<inaesthetic> sensations tell me of the movement and position of my limbs.

Page 4

Now I move my finger. I either hardly feel it or don't feel it at all. Perhaps a little in the tip of my finger, and sometimes at a point on my skin (not at all in the joint). And this sensation tells me that I move my finger and how? For I can describe it exactly. [Cf. *PI* II, viii, p. 185a; *LW* I, 386]

Page Break 5

But after all, you must feel the movement, otherwise you couldn't know how it was moving. But "knowing how" only means being able to state, to describe, it.

Page 5

I may be able to tell the direction from which a sound comes only because it affects one of my ears differently from the other; but I don't *hear* that. [See *PI* II, viii, p. 185b; *LW* I, 387]

Page 5

It is quite the same with the idea that it must be some feature of our pain that tells us of its whereabouts in the body, or some feature of our memory image that tells us the time to which it belongs. [See *PI* II, viii, p. 185c; *LW* I, 388]

Page 5

A sensation *can* tell us of the movement or position of a limb. And the character of the pain *can* also tell us where its cause†1 is situated. [Cf. *PI* II, viii, p. 185d; *LW* I, 389]

Page 5

How do I know that a blind person uses his sense of touch and a sighted person his sense of sight to tell them about the shape and position of objects? [*LW* I, 390]

Do I *know* this only from my own experience, and do I merely surmise it in others? [*LW* I, 391]

Page 5

Here we have, in addition to that description, another description of sensation (of what is sometimes called sense-data).

Page 5

What is the criterion for my learning the shape and colour of an object from a sense-impression? [*PI* II, viii, p. 185e; *LW* I, 393]

Page 5

What sense-impression? Well, *this* one. I can describe it. "It's the same one as the one----" or I can demonstrate it

Page Break 6
with a picture.

Page 6

And now: what do you feel when your fingers are in this position?

Page 6

"How is one to define a feeling? One can only recognize it within oneself." But it must be possible to teach the use of words! [*PI* II, viii, p. 185f; *LW* I, 394]

Page 6

What I am looking for is the grammatical difference. [*PI* II, viii, p. 185g; *LW* I, 395]

Page 6

The words rough†1 and smooth, cold and warm, sweet and sour, bitter...

Page 6

But why not also thin and thick?

Page 6

--- Can't there be a doubt here? Mustn't there be one, if it is a feeling that is meant? [See *PI* II, viii, p. 186b; *LW* I, 402]

Page 6

What would we say if someone reported to us that in a certain object he saw a colour he couldn't describe further? Does he have to be expressing himself correctly? Does he have to mean a colour? [*LW* I, 403]

Page 6

This looks *so*; *this* tastes *so*; *this* feels *so*. This and so must be differently explained. [*PI* II, viii, p. 186c; *LW* I, 404]

Page 6

I can observe the state of my depression. In that case I am observing what I for instance describe.

Page 6

A thought which one month ago was still unbearable to me is no longer so today. (A touch which was painful yesterday is not so today.) That is the result of an observation. [Cf. *PI* II, ix, p. 187b]

Page Break 7

Trying to recollect a mental mood can be called observing.

Page 7

What do we call 'observing'? Roughly this: putting oneself into the most favourable situation to receive certain impressions with the purpose, for instance, of describing them.

Page 7

When do we say that anyone is observing? Roughly: when he puts himself in a favourable position to receive certain impressions with the purpose, for example, of describing what they tell him. [*PI* II, ix, p. 187c]

Page 7

At bottom, I am still afraid.--I am afraid, I can't stand this fear!--I am afraid of his coming, therefore I am so restless.--Oh, now I am much less afraid of it than before. Now, just when I should be fearless, I am afraid!

Page 7

There could be various explanations:

I am afraid! I can't stand this fear!

I am afraid of his coming, and that is why I am so restless.

I am still a little afraid, although much less than before.

At bottom I am still afraid, though I won't confess it to myself.

Now, just when I should be fearless, I am afraid!

I am afraid; unfortunately, I must admit it.

I think I'm still afraid. [Cf. *PI* II, ix, p. 188a]

Page 7

The contexts in which a word appears are portrayed best in a play; therefore, the best example for a sentence with a certain meaning is a quote from a play. And who asks the character in a play what he experiences when he speaks?

Page Break 8

The best example of an expression with a very specific meaning is a passage in a play. [LW I, 424]

Page 8

--- Well, we assume several things. For instance, that they hear their own voices, and also sometimes feel things as they are gesturing and whatever else belongs to human life.

Page 8

To stir up a philosophical wasps' nest. Moore. [Cf. *C & V*, 2nd edn., p. 147]

Page 8

The language-game of reporting can be given such a turn that the report gives the person asking for it a piece of information about the one making the report, and not about its subject-matter. (Measuring in order to test the ruler.) [Cf. *LW I*, 416; *PI II*, x, p. 190d-191a]

Page 8

Momentary motion. [Cf. *LW I*, 425]

Page 8

If you see motion you by no means see the position at a point in time. You could not portray it. [See *LW I*, 425]

Page 8

Tacking on to:

Page 8

Back then I believed that the earth was a flat disc.--Just like that? [Cf. *LW I*, 426]

Page 8

"Knowing myself as I do, I will now act this way."

Page 8

The line vanishes into the dark.

There is no real point on it for... [Cf. *LW I*, 427]

Page 8

A different tacking on, if that's what you want, has to be according to a different *principle*.

Page 8

The question can be raised: Is a state that I recognize on

Page Break 9

the basis of someone's utterances really the same as the state he does not recognize this way? And the answer is a decision. [LW I, 428]

Page 9

The curve "to be in error".

Page 9

"To seem to believe", a verb. The first person present indicative is meaningless, because I know my intention. But that would be a development of "he believes". [Cf. *PI II*, x, p. 192b; *LW I*, 423]

Page 9

Or: If believing is a state of mind, it lasts. It doesn't last just while I am saying I believe, so it is a disposition. Why can't I say of myself that I have it? How do others recognize my disposition? They observe, they ask me. My answer doesn't have to be "I believe... ", but maybe "That's the way it is"; from this they recognize my disposition. And how do I recognize it? By random tests? My disposition might be, for instance, "This and that can be expected of me". *Doesn't it interest me?* [Cf. *PI II*, x, pp. 191i-192a]

Page 9

My own relation to my words is wholly different from other people's. [*PI II*, x, p. 192b]

Page 9

I do not listen to them and thereby learn something about myself. They have a completely different relation to my actions than to the actions of others.

Page 9

If I listened to the words of my mouth, I would be able to say that someone else was speaking out of my mouth. [*PI II*, x, p. 192c]

Page 9

"These days, I am inclined to say..."

Page 9

If someone says something with a great deal of conviction,

Page Break 10

does he believe it at least *while* he is saying it? Is belief *this* kind of state?

Page 10

With "I believe-----" he expresses his belief in no way better than with the simple assertion.

Page 10

My words and my actions interest me in a completely different way than they do someone else. (My intonation also, for instance.) I do not relate to them as an observer.

I *can* not observe myself as I do someone else, cannot ask myself "What is this person likely to do now?" etc.

Page 10

Therefore the verb "He believes", "I believed" *can* not have the kind of continuation in the first person as the verb "to eat".



Page 10

"But what *would* the continuation be that I was expecting?!" I can see none.

Page 10

"I believe *this*."--"So it appears I believe *this*."

Page 10

"Going by my utterances, I believe *this*; but it isn't so." [Cf. *PI* II, xq, p. 192d]

Page 10

"It seems to me I believe†1 this, but it isn't so."

Page 10

My words are parallel to *my* actions, his to his.

Page 10

A different co-ordination.

Page 10

I do not draw conclusions as to my probable actions from

Page Break 11

my words.

Page 11

That consistent continuation would be "I seem to believe". [Cf. *PI* II, x, p. 192b]

Page 11

From the very beginning, the assumption is surrounded by all forms of the word "to believe", by all of the different implications.

Page 11

For I have a mastery of his technique long before I reflect upon it. [Cf. *PI* II, x, p. 192e]

Page 11

"Judging from what I say, *this* is what I believe."

Page 11

(Now it would be possible to think of circumstances in which such an utterance would make sense. But we are not talking about this use of the word "belief".) [See *PI* II, x, p. 192d]

Page 11

And someone could also say "It's going to rain, but I don't believe it" if there were indications that two people were speaking through his mouth. Language-games would be played here which we could imagine, to be sure, but which normally we don't encounter. [Cf. *PI* II, x, p. 192d]

Page 11

And then it would also be possible for someone to say "It is raining, but I don't believe it". One would have to fill out the picture with indications that two personalities were speaking through his mouth.†1 [See *PI* II, x, p. 192d]

Page 11

Here it does look as if the assertion "I believe" were not the assertion of what is supposed in the hypothesis "I believe"!

Page 11

Therefore I am tempted to look for a different continuation of the verb in the first person indicative. [Cf. *PI*

Page Break 12

This is how I think of it: believing is a state of mind. It exists during a period of time, it doesn't attach to the time of its expression. So it is a *kind* of disposition. This is shown me in the case of someone else by his behaviour, by his words. And specifically by his expression "I believe" as well as the simple assertion. What about my own case? Do I study my disposition in order to make the assertion or the utterance "I believe"?---But *couldn't* I make a judgement about this disposition just like someone else? In that case I would have to pay attention to myself, listen to my words, etc., just as someone else would have to do. [Cf. *PI* II, x, pp. 191i-192a]

Page 12

I could find that continuation if only I could say "I seem to believe". [*PI* II, x, p. 192b]

Page 12

A wall covered with spots, and I occupy myself by seeing faces on it; but not so that I can study the nature of an aspect, but because those shapes interest me, and so does the spell under which I go from one to the next. [*LW* I, 480a]

Page 12

Again and again aspects dawn, others fade away, and sometimes I 'stare blindly' at the wall. [*LW* I, 480b]

Page 12

The double cross and the duck-rabbit might be among the spots and they could be seen like the figures and together with them now one way, now another. [Cf. *LW* I, 481]

Page 12

The dawning of aspects is related to the dawning of mental images.

Page 12

Just because I always used it as an 'f' doesn't mean that I have therefore *seen* it as an 'f'.

Page 12

'That can be an F.'

Page Break 13

The aspect seems to belong to the structure of the inner materialization. [*LW* I, 482]

Page 13

We learn language-games. We learn how to arrange objects according to their colours; how to report the colours of things, how to produce dyes in different ways, how to compare shapes, report, measure, etc. etc. Do we also learn how to form mental images out of them? [*LW* I, 483]

Page 13

There is a language-game "Report the colour... ", but not "Report *this* colour here".

Page 13

There is a language-game "Tell me whether this figure is contained in that one". (Also "how often" or "where".)

What you report is a perception. [*LW* I, 484]

Page 13

So we could also say: "Tell me whether there is a mirror-F here", and suddenly it might strike us that there is. This could be very important. [*LW* I, 485]

Page 13

But the report "Now I see it as--now as--" does not report any perception. [*LW* I, 486]

Page 13

You can think of it in this way, or in that way, then you see it now this way, now that. *How?*

Page 13

You can think now of *this*, now of *that*, as you look at it, look at it now as *this*, now as *that*, and then you will see it now *this* way, now *that* way. *What* way? There *is* no further qualification. [*LW* I, 487; *PI* II, xi, p. 200d]

Page 13

To be sure, if you look *that* way, furrowing your brows for instance, then you see it green, but otherwise red. In this way, the colour could teach me about the object after all. The prescription would simply be--you have to look *this* way.

Page Break 14

I can change the aspects of the F and in so doing I do not have to be cognizant of any other act of volition. [*LW* I,

---For the expression of the changing of the aspect is also the expression of congruence and dissimilarity.

Seeing and thinking in the aspect.

I look at an animal. I am asked "What do you see there?" I answer "A hare".---I gaze at the landscape; suddenly a hare runs by. I exclaim: "A hare!"

Both things, both the report and the exclamation, can be called expressions of perception and of visual experience. But the exclamation is so in a different sense from the report. It is wrung from us. It is related to the experience as a cry is to pain. [*PI* II, xi, p. 197b; *LW* I, 549b]

But since it is the description of a perception, it can also be called the expression of a thought. And therefore we can say that if you looked at the animal you would not have to think of the animal; but if you are having the visual experience expressed by the exclamation you are also thinking of what you see. [*PI* II, xi, p. 197c; *LW* I, 553]

And that is why the experience of a change of an aspect seems half visual-, half thought-experience. [Cf. *PI* II, xi, p. 197d; *LW* I, 554]

When I see a change of aspect, I am *occupied* with the object.†1 (Cf. *LW* I, 555)

I am occupied with what I am now noticing, with what strikes me. In that respect, experiencing a change of aspect is similar to an action. [*LW* I, 556]

It is a paying of attention.

What is the criterion of visual experience? What ought the criterion be?

The representation of 'what is seen'. [*PI* II, xi, p. 198b; *LW* I, 563]

Now when the aspect dawns can I separate a visual experience from a *thought-experience*? (And what does that mean?) If you separate them then the aspect is lost. [Cf. *LW* I, 564]

And what about the double cross? Again, it is seeing according to an interpretation. Seeing *as*.

Now when I recognize this person in a crowd, perhaps after looking in their direction for quite a while,--is this a sort of seeing? A sort of thinking?†1 The expression of the experience is "Look, there's...!" But of course, it could just as well be a sketch. That I recognize this one might be expressed in the sketch, or in the process of sketching as well. (But the element of sudden recognition is not expressed in the sketch.) [*LW* I, 571a; cf. *PI* II, xi, p. 197h]

Suppose a child suddenly recognizes someone. Let it be the first time he has ever suddenly recognized someone.--It is as if his eyes had suddenly opened.

One can ask, for example: if he suddenly recognizes so and so, could he have the same sudden visual experience, but without recognizing the person? Well, he might for instance be *mistaken* in recognizing him. [*LW* I, 572]

[I haven't yet estimated correctly the beginning that the child is making.]

What if someone were to ask: "Do I really do that with my eyes?" [*LW* I, 573]

The same expression which before was a report of what was seen now is an exclamation.

A hare runs across a path. Someone doesn't know it and says: "Something strange whizzed by" and he

proceeds to describe the appearance. Someone else says "A hare!", and he cannot describe it so precisely.

Now why do I still want to say that the person who recognizes it sees it differently from the person who doesn't? [LW I, 574]

Page 16

It is the well-known impression.

Page 16

Does someone who doesn't recognize a smile as a smile see it differently than someone who does? He reacts to it differently. [Cf. LW I, 575; PI II, xi, p. 198e]

What can be cited in support of his seeing it differently? [LW I, 576]

Page 16

"If one knows what it is, it looks different."--How so? [LW I, 577]

Page 16

What would it be like if someone were not acquainted with it, but still knows all about it right away? Does he then see it in the same way as the one who is acquainted with it?--What should I say? [Cf. LW I, 578]

Page 16

It's a question of the fixing of the concepts. [LW I, 579]

Page 16

I'm mentioning these kinds of aspects in order to show the kind of multiplicity we are dealing with here. [LW I, 580]

Page Break 17

Here there is a host of interrelated phenomena and concepts. [Cf. LW I, 581; PI II, xi, p. 199d]

Page 17

Sometimes the conceptual is dominant. (What does that mean?) Doesn't it mean: sometimes the experience of an aspect can be expressed only through a conceptual explanation. And this explanation in turn can take many forms. [LW I, 582]

Page 17

Here it is important to consider that there is a host of interrelated phenomena and concepts. [Cf. LW I, 581; PI II, xi, p. 199d]

Page 17

Just think of the words exchanged by lovers! They're 'loaded' with feeling. And surely you can't just agree to substitute for them any other progressions of sound you please. Isn't this because they are *gestures*? And a gesture doesn't have to be something innate; it is instilled, and yet *assimilated*.--But isn't that a myth?!--No. For the signs of assimilation are that I want to use *this* word, that I prefer to use none at all to using one that is forced on me, and similar reactions. [LW I, 712]

Page 17

"I noticed the likeness for maybe 5 minutes." "After 5 minutes I no longer noticed the likeness, but at first very strongly."

"After 5 minutes the likeness no longer struck me, but at first very strongly." [Cf. LW I, 707]

Page 17

... "I noticed the likeness for maybe 5 minutes, and then no longer." [Cf. LW I, 707; PI II, xi, p. 210f]

Page 17

"I'm no longer struck by it," but what happens when I am struck by it?

Well, I look at the face in such and such a manner, say this and that to myself or to others, think this and that. But is that *being struck* by the similarity? No, these are the *phenomena* of being struck, but these *are* 'what happens'.

Page Break 18

'Being struck' is a different (and related) type of concept from 'phenomenon of being struck'. [Cf. LW I, 708; PI II, xi, p. 211d]

Page 18

But aren't thinking and saying different *kinds* of things! And isn't the thinking the being struck?

Page 18

I can say such and such words to myself *without* thinking of their content.

Page 18

Thinking and inward speech (I do not say "talking to oneself") are different concepts. [LW I, 709; PI II, xi, p. 211f]

Page 18

Is being struck: looking and thinking?

Page 18

No. Many concepts *cross* here. [LW I, 710; PI II, xi, p. 211e]

Page 18

How does the chemist know that there is an Na atom at *this* point in the structure. A question of the criterion, not a psychological question. [Cf. LW I, 786]

Page 18

A child learns a certain way of writing our letters, but it doesn't know that there are ways of writing, and doesn't know the concept 'way of writing'.

Page 18

--- If not, one could not very well call it a blindness. [Cf. PI II, xi, p. 214a]

Page 18

--- Well, his defect will be more or less related to this one.

Page 18

But if I want to say "This word (in the poem) stood there like a picture†1

Page Break 19

Page 19

"The word (in the poem) is not different from a picture of what it means"---

Page 19

If the sentence can appear to me like a word-painting ('Joyous songs resound in the green dell†1)

Page 19

But if a sentence can strike me like a painting in words and the very individual word in the sentence like a picture, then it is not quite so much of a marvel that a word uttered outside of all context and without purpose seems to carry a particular meaning in itself. [PI II, xi, p. 215c]

Page 19

Experience of direction.

Page 19

Think here of a special kind of illusion which throws light on these matters. [Cf. PI II, xi, p. 215d; LW I, 787]

Page 19

In what way *is* a mental image, a word, etc., a germ? It is the beginning of an interpretation.

I was able to see a part of a line and then say it was N's shoulder, and then that it is N, who..., etc. But I did not deduce from the line that it is the shoulder etc.

Page 19

Now what does it mean to say that in searching for a name or a word one feels, experiences, a gap which can only be filled by a particular thing, etc. Well, these words could be the primitive expression in the place of the expression "The word is on the tip of my tongue". James's expression is actually only a paraphrase of the usual one.

Page 19

James really wants to say: What a remarkable experience! The word is not here and yet already here, or something is

Page Break 20

here which cannot grow into anything but this word. But this is not experience at all. The words "It's on the tip of my tongue" are not the expression of an experience and James only interprets them as the description of the content of an experience. (Cf. PI II, xi, p. 219d; LW I, 841]

Page 20

"It's on the tip of my tongue" no more expresses an experience than "Now I've got it!" It's an expression which we use in certain situations and is surrounded by a certain behaviour, and also by several characteristic experiences. [Cf. PI II, xi, p. 219e; LW I, 842]

Page 20

Doesn't something special happen after all when a word comes to you? Listen carefully.--Listening carefully doesn't do you any good. You could do no more than discover what's going on in yourself at that time. [Cf. PI II, xi, p. 219a]

Page 20

And how, when I'm doing philosophy, can I listen *for that* at all. And yet I can imagine that I do. How does that come about? What am I actually paying attention to?

Page 20

Could one imagine that people view lying as a kind of insanity. They say "But it isn't true, so how can you say it then?!" They would have no appreciation for lying. "But he won't say that he is feeling pain if he isn't!--If he says it anyway, then he's crazy." Now one tries to get them to understand the temptation to lie, but they say: "Yes, it would certainly be pleasant if he believed---, but it isn't *true!*"--They do not so much condemn lying as they sense it as something absurd and repulsive. As if one of us began walking on all fours.

Page 20

In which way does uncertainty, the possibility of deceit,

Page Break 21

create difficulties with the concept of pain?? [Cf. *LW I*, 876]

"I am *certain* that he's in pain."--What does that mean? How does one use it? What is the expression of certainty in behaviour, what *makes* us certain?

Not a proof. That is, what makes me certain doesn't make someone else certain. But the discrepancy has its limits.

Page 21

Don't think of being certain as a mental state, a kind of feeling, or some such thing. The important thing about certainty is the way one behaves, not the inflection of voice one uses in speaking.

Page 21

The belief, the certainty, a kind of feeling when uttering a sentence. Well, there is a *tone* of conviction, of doubt, etc.. But the most important expression of conviction is not this tone, but the way one behaves.

Page 21

When you think that one can be certain that someone else is in pain you shouldn't ask "What goes on in me†1 then?", but "How does that get expressed?"

Page 21

Ask not "What goes on in us when we are certain---?", but "How does it show?" [Cf. *PI II*, xi, p. 225b]

Page 21

A man's thinking goes on within his consciousness in a seclusion in comparison with which any physical seclusion is openness.†2 [*PI II*, xi, p. 222c]

Page 21

The future is hidden from us. But does the astronomer feel that who calculates an eclipse of the sun? [Cf. *PI II*, xi, p. 223d]

Page Break 22

Page 22

The inner is hidden.----The future is hidden. [*PI II*, xi, p. 223d]

Page 22

But doesn't *the same thing*----i.e. the same feeling----correspond to the word in the primitive exclamation and in the statement†1? Doesn't the child who cannot yet speak have the same feeling as the one who can? *How* can they be compared? Well, compared *this way* it is the same feeling.

Page 22

Doesn't the child in a primitive way express precisely that feeling that the other one *reports*?

Page 22

Logical impossibility and psychological impossibility.

Page 22

If I see someone writhing in pain with evident cause I do not think, all the same, his feelings are hidden from me. [*PI II*, xi, p. 223e]

Page 22

"Such and such is the case." On the one hand it has the sound, on the other the striding nature, of a sentence. It is a *motion* which begins and comes to an end. Precisely not *one* sign, which designates something, but rather something that has *sense*, which sets up a sense that exists without regard to truth or falsity.†2 It is the arrow and not the point.

(But where is the mistake?)

Page 22

"... is the case" is simply a sentence. But I would not after all have used just any other meaningful sentence in its place.

Page 22

Our concept is of such a kind.--But could we have a different one then? One that brings behaviour, occasion and

Page Break 23

experience†1 into a necessary connection? Why not? But in that case we would have to be made in such a way that all of us or almost all of us in fact would react in the same way†2 under the same circumstances. For when we believe that the expression of his feelings is genuine, in general we behave differently from when we believe the opposite.

Page 23

But this correspondence does *not* exist, and therefore we would not know what to do with a necessary concept. (Heap of stones.†3)

Page 23

--- therefore because different things speak for the truth of his statement, and the statement has different consequences.

Page 23

--- If he is sincere he can†4 tell us them, but my sincerity is not enough to guess his motives. This is where there is the similarity with knowing. [Cf. *PI* II, xi, p. 224f]

Page 23

Subjective and objective certainty. [Cf. *PI* II, xi, p. 225c]

Page 23

Why do I want to say " $2 \times 2 = 4$ " is objectively certain, and "This man is in pain" only subjectively? [Cf. *PI* II, xi, p. 224e]

Page 23

There can be a dispute over the correct result of a calculation, for instance, of a rather long addition.†5 But such a dispute is rare and is quickly decided if it arises.

This is a fact that is essential for the function of mathematics.

Page Break 24

Page 24

[Physicist, paper and ink, reliability.] [Cf. *PI* II, xi, p. 225d; cf. also p. 226b, c]

Page 24

There can also be a disagreement about what colour an object is. To one person it appears as a somewhat yellowish red, to another as a pure red. Colour blindness can be recognized by specific tests.

Page 24

There is no such agreement over the question whether an expression of feeling is simulated or genuine. [See *PI* II, xi, p. 227e]

Page 24

Why not?--What do you want to know?

Page 24

Let's assume you say: *This* man distrusts the utterance because he is more distrustful than that man, who trusts it.

The question is, how can the disposition of the one making the judgement play an important role here if it doesn't do so elsewhere? Or also: How can such a judgement then be *correct*? How can one nevertheless speak of a judgement here?†1

Page 24

I want to call the observations on mathematics which are part of these philosophical investigations "the beginnings of mathematics". [Cf. *PI* II, xiv, p. 232b; *LW* I, 792]

Page 24

We are playing with elastic, indeed even flexible concepts. But this does not mean they can be deformed *at will* and without offering resistance, and are therefore *unusable*. For if trust and distrust had *no* basis in objective reality, they would only be of pathological interest.

Page 24

But why do we not use more definite concepts in place of these vague ones?

Page Break 25

But *not*: objective certainty does not exist *because* we do not see into someone else's soul. This expression means that.

Page 25

If constant quarrels were to erupt among mathematicians concerning the correctness of calculations, if for instance one of them were convinced that one of the numbers had changed without his noticing it or his memory had deceived him or someone else, etc. etc.--then the concept of 'mathematical certainty' would either not exist or it would play a different role than it does in fact. It could be the role of the certainty, for instance, that God answers a prayer for rain; either by sending rain or by not sending it--for such and such and such reasons. [Cf. *PI II*, xi, p. 225d]

Page 25

Then it might be said, for instance: "True, we can never be certain[†]1 what the result of a calculation is, but it always has a quite definite result, which God knows.

It is of the highest certainty, though we only have a crude reflection of it." [*PI II*, xi, pp. 225e-226a]

Page 25

If I say therefore "In all schools in the world the same multiplication tables are taught"--what kind of a statement is that? It is one about the concept of the multiplication table. [Cf. *PI II*, xi, p. 227c]

Page 25

"In a horse race the horses generally run as fast as they can." In this way one could explain to someone what the word "horse race" means. [Cf. *PI II*, xi, p. 227c]

Page 25

As 'mathematical certainty' falls, so does 'mathematics'.

Page Break 26

Think of *learning* mathematics and the role of its formulas.

Page 26

Show what it's like when one is in pain.---Show what it's like when one pretends that one is in pain.

Page 26

In a play one can see both portrayed. But now the difference! ([[sic]] Cf. *LW I*, 863]

Page 26

--- How would they learn to use the words? And is the language-game they learn still the same one we call the use of colour-words?

Page 26

--- In saying this one could want to say that in *none* of our schools a fool taught arithmetic. However it can[†]1

Page 26

There is such a thing as colour-blindness and there are ways of establishing it. Among those who are not colour-blind there is in general no argument about (their) colour-judgements.

This is a remark about the concept of colour-judgements. [See *PI II*, xi, p. 227d; cf. *LW I*, 931]

Page 26

And yet I am not happy about this expression. Why? Is it only because a child doesn't actually *learn* to dissimulate? Indeed, it would not even have to *learn* what surrounds dissimulation. Imagine a child were born with the behaviour of a grown-up. Certainly it cannot yet talk, but it already has decided likes and dislikes, and clearly expresses joy, disgust, thankfulness, etc., in its facial expressions and gestures.

So does it already have to be able to nod its head? Or use certain inflections of sounds? [Cf. *LW I*, 945]

Page 26

--this particular and not at all simple pattern in the drawing

Page Break 27

of our life.[†]1 (Cf. *PI II*, xi, p. 229a]

Page 27

And what would the opposite now look like?--How well defined would the borders of evidence be?

One would recognize only with the possibility of error that someone was, for example, sad. But what kind of

concept of sadness is that now? The old one?

Page 27

A tribe in which no one ever dissimulates, or if they do, then as seldom as we see someone walking on all fours in the street. †2 Indeed if one were to recommend dissimulation to one of them, he might behave like one of us to whom one recommends walking on all fours. But what follows? So there is also no distrust there. And life in its entirety now looks completely different, but not on that account necessarily more beautiful as a whole.

Page 27

It doesn't yet follow from a lack of dissimulation that each person knows how someone else feels.

Page 27

But this too is imaginable.--If he looks like *this*, then he is sad. But that does not mean: "If he looks like this, then *that* is going on within him," but rather something like: "If he looks like this, then we can draw with certainty those conclusions which *we* frequently only can draw without certainty; if he does not look like that, we know that these conclusions are not to be drawn".

Page 27

One can say that our life would be very different if people said all of those things aloud that they now say to themselves, or if this could be read externally.

Page Break 28

But now imagine you were to come into a society in which, as we want to say, feelings can be recognized with certainty from appearances (we are *not* using the picture of the inner and the outer). But wouldn't that be similar to coming from a country where many masks are worn into one where no, or fewer, masks are worn? (Thus perhaps from England to Ireland.) Life is just *different* there.

Page 28

Frequently one will say: I do not *understand* these people. [Cf. *PI* II, xi, p. 223f]

One also says: I don't understand this person's joy and sadness. And what does that mean? Doesn't it mean that as I understand the words he is actually not sad and not happy? And now what does it mean to say: Maybe exactly the same thing is going on within him as within me, only it is expressed differently?

Page 28

Consider that we not only fail to understand someone else when he hides his feelings, but frequently also when he does not hide them, indeed when he does his utmost to make himself understood.

Page 28

Under certain circumstances, "The inner is hidden" would be as if one said: "All that you *see* in a multiplication is the outer movement of figures; the multiplication itself is hidden from us."

Page 28

The uncertainty as to what is going on within someone else does not stand against his own utter lack of doubt. [Cf. *LW* I, 963]

Page 28

If I say "I don't know for sure what he wants", that does not mean: by contrast with the man himself. For it can be completely clear to me what he wants without this therefore being *my* wish.

Page Break 29

I can only guess what he's calculating in his head. If it were otherwise, I could report it to someone and have it confirmed by the one doing the calculating. But would I then know of *everyone* who calculates what he is calculating? How do I make the connection with him? Well, here one or the other thing can be assumed.

Page 29

What do I know when I know that someone is sad? Or: what can I do with this knowledge?--For instance, I know what is to be expected from him.

But if I now also know that this or that will cheer him up, then *that* is a different kind of knowing.

Page 29

Even if I were now to hear everything that he is saying to himself, I would know as little what his words were referring to as if I read *one* sentence in the middle of a story. Even if I knew everything now going on within him, I still wouldn't know, for example, to whom the names and images in his thoughts related.

Page 29

After all, you can't expect a human to be more transparent than a closed crate, for instance.

Page 29

But this remains, that sometimes we do not know whether someone is in pain, or is only pretending.

And if it were otherwise, there would be various possibilities.

Page 29

Tennis without a ball--silent speaking and lip-reading. [Cf. *LW I*, 854-855]

Page 29

It is not the case that every time someone screams he is in pain; rather, if he screams under certain circumstances which are difficult to describe, and acts in a way that is difficult to describe, then we say he is in pain, or is probably in pain.--And what *are* pains?--For I must be able to explain this word, after all. Well, I might prick him with a needle

Page Break 30

and say *that* is pain. But given what we've said above, it can't be that easy to explain. Thus the whole concept of 'pain' becomes tangled.

The way in which we learn to use the word, and therefore the way in which it is used, is more complicated, difficult to describe. For instance it is first taught under certain circumstances where there is no doubt, i.e. where there is no question of doubt.

Page 30

The uncertainty that is always there is not about whether he is perhaps pretending (for he could have been imagining that he was pretending), but rather is about the complicated connection of the words 'to be in pain' with human behaviour. When such a concept is useful is another question.

Page 30

How can I learn to describe these circumstances? Was I taught to do it? Or what would I have to observe to do this?

Page 30

And just as little can I describe the circumstances in which one says that someone is pretending, feigning pain.

Is such a description of interest? Under certain circumstances a good number of its aspects are of interest.

Page 30

Why can't you be certain that someone is not pretending?--"Because one cannot look into him."----But if you could, what would you see there?----"His secret thoughts."----But if he only utters them in Chinese,--where do you have to look then?----"But I cannot be certain that he is uttering them truthfully!"----But where do you have to look to find out whether he is uttering them truthfully?

Page 30

What goes on within also has meaning only in the stream of life. [See *LW I*, 913]

Page Break 31

"But for him there is no doubt, after all, about whether he is pretending. So if I could look into him, there wouldn't be any for me either."

Page 31

How about this: Neither I nor he can know that he is pretending. He may confess to it and in that case, to be sure, there is no error. I may assume it with full certainty and good reasons, and what follows may confirm that I was right.

Page 31

Or: I can know that he is in pain, or that he is pretending; but I do not know it because I 'look into him'.

Page 31

But if a way of seeing his nerves working were now found, wouldn't that really be a means of finding whether he is in pain? Well, it could give a new direction to the way we behave and could also correspond more or less with the old directions. And could you ask for more than to see the workings of the nervous system?

Page 31

It can happen that I don't know whether he is pretending or not. If that is the case, what is the reason? Could one say: "That <I> don't see his nervous system working"?

But does there have to be *a reason*? Couldn't I simply know whether he is pretending without knowing how I know it?

I simply would have 'an *eye*' for it. [c: cf. *PI II*, xi, p. 228e]

Page 31

I don't know what he is saying behind my back----but does he also have to *think* something behind my back?

Page 31

That is: what goes on in him is also a game, and pretence

Page Break 32

is not *present* in him like a feeling, but like a game.

Page 32

For also, if he speaks to himself his words only have meaning as elements of a language-game.

Page 32

On the one hand I cannot know whether he is pretending because our concept of pretence, and therefore of the certainty of pretence, is what it is----on the other hand, because, even assuming a somewhat different concept of pretence, certain facts are as they are.

For it is conceivable that we could have access to criteria of pretence which are not in fact accessible, and that if they became accessible to us we would really take them as criteria.

Page 32

What am I hiding from him when he doesn't know what is going on inside me?

How and in which way am I hiding it?

Page 32

Physically hidden----logically hidden.

Page 32

I say "This man is hiding what is in him". How does one know that he is hiding it? Thus there are signs for it and signs against it.

Page 32

There is an *unmistakable* expression of joy and its opposite.

Page 32

Under these circumstances one *knows* that he is in pain, or that he isn't; under those, one is uncertain.

Page 32

But ask yourself: what allows one to recognize a sign for something within as infallible? All we are left with to measure it against is the outer. Therefore the contrast between the inner and the outer is not an issue.

Page Break 33

Yet there *are* cases where only a lunatic could take the expression of pain, for instance, as sham.

Page 33

"I don't know whether he likes or dislikes me; indeed I don't even know whether he knows it himself."

Page 33

Is it logically or physically impossible to know whether someone else remembers something?

Page 33

I say that I don't remember, but in reality I do. What I want to say is that it is not at all a matter of what goes on within me *as I speak*. So actually I am not *hiding* anything at all from him, for even if something is going on within me, and he can never see it, then what is going on here cannot interest him.

So does that mean that I am not lying to him? Of course I am lying to him; but a lie about inner processes is of a different category from one about outer processes.

Page 33

If I lie to him and he guesses it from my face and tells me so--do I still have the feeling that what is in me is in no way accessible to him and hidden? Don't I feel rather that he sees right through me?

Page 33

It is only in particular cases that the inner is hidden from me, and in those cases it is not hidden because it is the inner.

Page 33

Suppose that we had a kind of snail shell, and that when our head was outside then our thinking, etc., was not private, but it was when we pulled it in.

Page 33

One might think of cases in which someone turns his face away so that the other cannot read it.

Page 33

My thoughts are not hidden from him if I utter them involuntarily and he hears this. Oh yes they are, because

Page Break 34

even in that case *he* doesn't know whether I really mean what I say, and I do know it. Is that correct?

But in what does that consist that I know whether I mean it? And above all: Can't he know it too?

And what if my honest confession were less reliable than someone else's judgement?

Or: What kind of a fact is it: that it is *not* so?

Page 34

If the consequences that can generally be based on the confession of my motive could not be based on it, that would mean that this whole language-game didn't exist.

Page 34

A problem of relativity.

Page 34

In general I can sketch a clearer more coherent picture of my life than someone else.

Page 34

The question could also be put this way: Why does one in general aim toward a *confession* in the case of a crime, for instance. Does this not mean that a confession is more reliable than any other report?

Page 34

Therefore at bottom there must be a general fact here (similar for instance to the one that I can predict the movements of my own body).

Page 34

Roughly, it must be the case that in general I can give a more coherent report about my actions than someone else. In this report the inner plays the role of theory or construction, which complements the rest of it to form a comprehensible whole.

Page 34

All the same: There are other criteria for my reliability.

Page 34

My thoughts are not hidden from him, but are just open

Page Break 35

to him in a different *way* than they are to me.

Page 35

The language-game simply is the way it is.

Page 35

If one speaks of being *logically* hidden, then that is a bad interpretation.

Page 35

"I know what I mean." What does that mean? For instance, that I didn't simply speak to hear myself talk, that I can explain what I mean and the like. But would it be correct to say it about my everyday speech? Or doesn't someone else know it just as well.

Page 35

"I know whether I am lying or not."

Page 35

The question is, how does the mendacious utterance turn into something important?†1

Page 35

Do not look at pretending as an embarrassing appendage, as a disruption of the pattern.

Page 35

One can say "He is hiding his feelings". But that means that it is not a priori they are always hidden. Or: There are two statements contradicting one another: one is that feelings are essentially hidden; the other, that someone is hiding his feelings from me.

Page 35

If I can never know what he is feeling, then neither can he pretend.

Page 35

For pretending must mean, after all, getting someone else

Page Break 36

to *make a wrong guess* as to what I feel. But if he now guesses right and is certain of being right, then he knows it. For of course I can also get him to guess *right* about my feelings and not be in doubt about them.

Page 36

The inner is hidden from us means that it is hidden from us in a sense in which it is not hidden from *him*. And it is not hidden from the owner in this sense: *he utters it* and we believe the utterance under certain conditions and there is no such thing as his making a mistake here. And this asymmetry of the game is brought out by saying

that the inner is hidden from someone else.

Page 36

Evidently there is an aspect of the *language-game* which suggests the idea of being private or hidden--and there is also such a thing as hiding of the inner.

Page 36

If one were to see the working of the nerves, utterances would mean little to us and pretending would be different.

Page 36

Or should I say that the inner is not hidden, but rather *hide-able*? He *can* hide it within himself. But that's wrong again.

Page 36

"He screams when he is in pain, not I." Is that an empirical sentence?

Page 36

"I am feigning pain" doesn't stand on the same level as "I am in pain". After all, it is not an utterance of feigning.

Page 36

"When does one say that someone is in pain?" That is a sensible question, and has a clear kind of answer.----"When does one say that someone is feigning pain?" After all that must be a sensible question too.

Page 36

Can one imagine the signs and the occasions of pain being

Page Break 37

something utterly other than what they actually are? Say their being signs, etc., of joy?----So the signs of pain and pain-behaviour determine the concept 'pain'. And they also determine the concept 'feigning pain'.

Page 37

Could one imagine a world in which there could be no pretence?

Page 37

If one 'is sad because one cries', why then isn't one also in pain because one screams?

Page 37

One has to look at the concepts 'to be in pain' and 'to simulate pain' in the *third and first* person. Or: the infinitive covers all persons and tenses. Only the whole is the instrument, the concept.

Page 37

But what then is the point of this complicated thing? Well, our behaviour is damned complicated, after all.

Page 37

And how is it with feelings' being private or hidden?

Page 37

A society in which the ruling class speaks a language which the serving class cannot learn. The upper class places great importance on the lower one never guessing what they feel. In this way they become unfathomable, mysterious.

Page 37

What kind of hiding is the speaking of a language that the other cannot understand? [Cf. *PI* II, xi, p. 222d]

Page 37

Is the if-feeling (for instance) the readiness to make a certain gesture. And does its being related to feelings consist in that? [Cf. *PI* II, vi, p. 181e-182a-f]

Page 37

We interpret the word "if", spoken with this expression, as the expression of a feeling. [Cf. *LW* I, 373-376]

Page Break 38

Page 38

The use (of the word) seems to fit the word.

Page 38

Question: is the *wenn*-feeling the same as the if-feeling? If one wants to decide this question one enunciates the words to himself with their characteristic intonation.

Page 38

Instead of "attitude toward the soul" one could also say "attitude toward a human". [See *PI* II, iv, p. 178d]

Page 38

I could always say of a human that he is an automaton (I could learn it this way in school in physiology) and

yet it would not influence my attitude toward someone else. After all, I can also say it about myself.

Page 38

But what is the difference between an attitude and an opinion?

I would like to say: the attitude comes *before* the opinion.

Page 38

(Isn't belief in God an attitude?) [a, b: cf. *PI* II, iv, p. 178d]

Page 38

How would this be: only one who can utter it as information *believes* it.

Page 38

An opinion can be wrong. But what would an error look like here?

Page 38

Is the if-feeling the correlate of an expression?--Not *solely*. It is the correlate of meaning and of the expression. †1

Page 38

The atmosphere of a word is its use. Or: We imagine its

Page Break 39

use as its atmosphere. [Cf. *PI* II, vi, p. 182d]

Page 39

The 'atmosphere' of a word is a picture of its use.

Page 39

We look at a word in a certain environment, spoken with a certain intonation, as an expression of feeling.

Page 39

This passage has a *strong* expression. It is immensely expressive. I repeat it to myself again and again, make a special gesture, paraphrase it. But a feeling? Where is it? I'd almost like to say: in the stomach. And yet it is immediately clear that no (such) feeling exhausts the passage. The passage is a gesture. Or it is related to our language. One could also imagine a drawing that would be impressive in the same way.

Page 39

The if-feeling: Could we imagine a poem in which we would sense this feeling especially strongly? ('Sabre'-feeling.)

Page 39

Only I can utter my thoughts, feelings, etc.

The utterances of my feelings can be sham. In particular they can be feigned. That is a different language-game from the primitive one, the one of genuine utterances. †1

Page 39

Is there anything astonishing in this?

Page 39

Is there anything astonishing about the possibility of a primitive and a more complicated language-game?

Page 39

"The child doesn't know enough yet to pretend." Is that right?

Page Break 40

Page 40

The question is: When would we say of a child, for instance, that it is pretending? What all must it be able to do for us to say that?

Only when there is a relatively complicated pattern of life do we speak of pretence. [Cf. *PI* II, xi, p. 229b; *LW* I, 939-940, 946]

Page 40

Or to put it another way: Only when there is a relatively complicated pattern of life do we speak of certain things as possibly being feigned. [Cf. *LW* I, 946]

Page 40

Of course this is not a common way of looking at things.

Page 40

It is a purely geometric way of looking at things, as it were. One into which cause and effect do not enter.

Page 40

One could ask, "What does a battle (for instance) look like?" What picture does it present? Here it doesn't matter to us whether a sword splits a skull and whether someone falls down because his skull was split.

Page 40

To say "He knows what he is thinking" is nonsense; "I know what he is thinking" may be true. [Cf. *PI* II, xi, p. 222b]

Page 40

If as I was assuming people really could see someone else's nervous system working, and adjust their behaviour toward him accordingly, then, I believe, they wouldn't have our concept of pain (for instance) at all, although maybe a related one. Their life *would simply look quite different from ours*.

Page 40

That is, I look at this language-game as autonomous. I merely want to describe it, or look at it, not justify it.

Page 40

I do not say that evidence makes the inner *merely* probable.

Page Break 41

For as far as I'm concerned nothing is lacking in the language-game. [Concerning "evidence", cf. *PI* II, xi, p. 228b-d]

Page 41

That the evidence makes the inner only probable consists in†1

Page 41

"But after all I must be able to say, whether it's right or wrong, that someone is in pain, or again that they are pretending!"--Right and wrong exist only to the extent of the evidence.

Page 41

But in any case I can *think* that I am right or wrong;--whether the evidence is sufficient or not! What good does it do me that I can think it?--More than that I can *say* it!----To be sure an image may be in my mind, but how do I know that, and how, it can be used?

Page 41

The image and its use would therefore have to be in my mind.

Page 41

At first it could be said that it is our determination whether we see something as a definite criterion of pain (for instance), whether we see all of this as a criterion of anything at all. But then we have to say that the whole thing is *not* our determination, but is rather a part of *life*.

Page 41

Can an idiot be too primitive to pretend? He could pretend the way an animal does. And this shows that from here on there are levels of pretence.

Page 41

There are very simple forms of pretence.

Page 41

Therefore it is possibly untrue to say that a child has to learn a lot before it can pretend. To do this it must grow, develop, to be sure. [Cf. *LW* I, 868, 939]

Page 41

An animal cannot point to a thing that interests it.

Page Break 42

One will only speak of pretence if there are different cases and degrees of pretence.

Page 42

A great variety of reactions must be present.

Page 42

A child must have developed far before it can pretend, must have learned a lot before it can simulate.

Page 42

That is: simulating is not an experience.

Page 42

The possibility of pretence seems to create a difficulty. For it seems to devalue the outer evidence, i.e. to annul the evidence.

Page 42

One wants to say: Either he is in pain, or he is experiencing feigning. Everything on the outside can express either one.

Page 42

Above all pretence has its own outward signs. How could we otherwise talk about pretence at all?

Page 42

So we are talking about patterns in the weave of life.

Page 42

So do you want to say that the l.p.†1 of genuine and feigned pain do not exist?

Page 42

But can I describe them?

Page 42

Imagine it were really a case of patterns on a long ribbon.

The ribbon moves past me and now I say "This is the pattern S", now "This is the pattern V". Sometimes for a period of time I do not know which it is; sometimes I say at the end "It was neither".

How could I be taught to recognize these patterns? I am shown simple examples, and then complicated ones of both

Page Break 43

kinds. It is almost the way I learn to distinguish the styles of two composers.

But why in the case of the patterns does one make this distinction *that is so difficult to grasp*? Because it is of importance in our life.

Page 43

The main difficulty arises from our imagining the experience (the pain, for instance) as a thing, for which of course we have a name and whose concept is therefore quite easy to grasp.

Page 43

So we always want to say: We know what "pain" means (namely *this*), and so the difficulty only consists in simply not being able to determine this in someone else with certainty. What we don't see is that the *concept* 'pain' is only beginning to be investigated. The same is true of pretence.

Page 43

Why don't we form a simpler concept?--Because it wouldn't interest us.--But what does that mean? Is it the correct answer?

Page 43

Should I say: Our concepts are determined by our interest, and therefore by our way of living†1?

Page 43

As children we learn concepts and what one does with them simultaneously.

Sometimes it happens that we later introduce a new concept that is more practical for us.--But that will only happen in very definite and small areas, and it presupposes that most concepts remain unaltered.

Page 43

Could a legislator abolish the concept of pain?

The basic concepts are interwoven so closely with what

Page Break 44

is most fundamental in our way of living that they are therefore unassailable.

Page 44

Everything I say presupposes that there is a house over there. Or rather: this is presupposed in them. So for instance: A is in *this* house = There is a house over there and A is in it.

Page 44

Is it correct to say that the order "Go into the house!" presupposes that there is a house there and that the person giving the order knows it?

Page 44

If someone were to say "Go into this house" when there is no house there, we would say of him: "He believes that there is a house there". But is this less right when there actually is one there?

Page 44

From a practical sentence no philosophical one can follow. Moore's sentence was a practical one left indeterminate.

Page 44

Can we imagine that other people have other colour concepts?---The question is: should we call other

concepts colour concepts?

Page 44

Does the dog believe that his master is in front of the door, or does he *know* it?

Page 44

Bad influence of Aristotelian logic. The logic of language is immeasurably more complicated than it looks.

[Cf. *LW I*, 525]

Page 44

The examples which philosophers give in the first person should be investigated in the third.

Page 44

Imagine the situation in which we ask someone: "Do you believe that, or do you know it?"

Page Break 45

In what cases does one say "He knows it", and in which ones "He doesn't *know* it"?

Page 45

Consider the question: "Does he know that is a book?" And particularly the use of the word "that".

Page 45

"I see it exactly and know that *it* is a book."

Page 45

"I know that that is a tree."----"That *what* is a tree?"

Page 45

"I don't know whether it is a tree, but I do know that it is a physical object."

Page 45

You say "That is a tree" and also that by "that" you mean the visual image. That allows a substitution in the first sentence.

Page 45

If one says, "I know that a physical object corresponds to this impression", then one is referring to a confirmation through other impressions.

Now if one doesn't acknowledge this kind of a confirmation--one is changing the language-game.

Page 45

"I know."

"I am certain."

We say, for instance, "I know that it is so" if someone reports a well-known fact to us. In this case we do not say "I am certain that it is so". ("I know that that is the Schneeberg.") Were I to answer "I am certain that it is the Schneeberg", then one would say "It isn't subject to any doubt at all!"

Page 45

Imagine that one were to explain "I know it" as: I learned it and it isn't subject to doubt.

Page 45

Imagine someone were to doubt that a tree is called "tree".

Page Break 46

Page 46

"I know that this is the earth"--saying which I stamp my foot on the ground.

Doubting. What kind of a game is this in which one asks: "How certain is this sentence for you?" [Cf. *OC*, 387]

Page 46

Would it be correct to say: "I sit down because I know that this is a chair; I reach for something because I know that that is a book; etc. etc." What is gained by this? I am using it to say that all these doubts do not exist for me. Further, that doesn't mean that they don't exist at all.

Page 46

No doubt arises about all of this. But that is not enough. In a certain class of cases we don't know what consequences doubt would have, how it could be removed, and, therefore, what meaning it has.

Page 46

What then does this belief that our concepts are the only reasonable ones consist in? That it doesn't occur to us that others are *concerned* with completely different things, and that our concepts are connected with what interests us, with what matters to us. But in addition, our interest is connected with particular facts in the outer world.

Page 46

But do we always have to be able to give the reason for the formation of a concept?

Page 46

"That wouldn't be a smile at all."

Page 46

Why should a *movement* not belong to a smile?

Page 46

"There's something mechanical about that smile." "Actually it is not a real smile at all." Only in a chess game does one call something "castling".

Page 46

"Why do we have a concept 'to pretend'? "--"Well,

Page Break 47

because humans often pretend."--Is that the right answer? [Cf. *LW I*, 255, 261]

Page 47

What if someone were to answer: "Because with this concept we can do those things we want to do"? Isn't it as if one were to ask: "Why do we have the concept of irrational numbers?" How could one answer that?

Page 47

We acknowledge a truthful person's statement about what he has just thought as well as his statement about what he has dreamed.

Page 47

Even if we *frequently* could guess someone's thoughts and were to say we know what they are, then the criterion for that could only be that he himself confirmed our guess. Unless we totally change the concept of thought. [Cf. *PI II*, xi, p. 222e]

Page 47

We paint pictures of transparent yellow, green, blue and red glasses with different backgrounds so that we get clear as to what the appearance of coloured translucency is. And now analogously we want to paint the picture of a transparent white glass.

Page 47

We can express ourselves in physical terms here although the physical doesn't interest us. It is a good image of what we want to describe.--A transparent yellow glass reflects no yellow light into the eye, and therefore the yellow doesn't seem localized in the glass. Flat black seen through yellow glass is black, white is yellow. Therefore analogously black must appear black seen through transparent white, and white white, i.e. just as through a colourless glass.--Is red now to appear whitish? i.e. pink? But what will a dark red, which tends toward black, appear as? It should become a blackish pink, i.e. a greyish red, but then black probably will not remain black.

Page Break 48

By 'pure white' one often means the lightest of all colours, by black the darkest; but not so by pure yellow, red, etc.

Page 48

White seen through yellow wouldn't become yellowish-white, but *yellow*. And yellow seen through white--should it become whitish--yellow or white? In the first case the 'white' glass acts like colourless glass, in the second like opaque glass.

Page 48

Thus I want to say: The '*pure*' concept of colour, which one is inclined to create from our normal colour concepts, is a chimera. To be sure there are different colour concepts and among them those that can be called purer and less pure.

Page 48

Instead of "chimera" I could have said "false idealization".

Perhaps the Platonic ideas are false idealizations.

If there is such a thing then, someone who idealizes falsely must talk nonsense--because he uses a mode of speaking that is valid in *one* language-game in another one where it doesn't belong.

Page 48

If types are deposited somewhere, who says *which* types? All that can be thought of?!

Page 48

What is the ideal representation of colour? Isn't it something like looking through a tube and seeing a small red circle (for instance)?--And am I now to name the colours according to this experience? Fine, but now I also have to apply these colour words in completely different cases. And how am I to compare them with the colours around me? And how useful will such a comparison be?--Or is the ideal way of showing a colour to fill the entire visual field

with it? As when one turns one's gaze towards the blue sky? But the old question still remains. For don't forget that your glance wanders and that *the* description of what you see doesn't exist.

Page Break 49

'It doesn't make any *sense*: he *knows* my thoughts.' Thus the inquiry after someone else's thoughts is not the game in which "knowing" should be applied.--Thus the sentence refers to the entire language-game.†1

Page 49

But does an astronomer calculating an eclipse of the moon say that the future can never be known? That is said when one feels uncertain about it.----Does the manufacturer say that of course one cannot know†2 whether his cars will work? [Cf. *PI* II, xi, p. 223d; cf. *LW* I, 189]

Page 49

Whoever utters that sentence makes a distinction, draws a line; and it may be an important line.--Does it become more important because of actual uncertainty?

Page 49

Then one can ask: What is the characteristic of what we can really know? And the answer will be: One can only *know* where no error is possible, or: where there are clear rules of evidence.

Page 49

"I know that he enjoyed seeing me."--What follows from that? What of importance follows? Forget that you have the correct idea of the state of his mind! Can I really say that the importance of this truth is that it has certain consequences?--It is pleasant to be with someone who is glad to see us, who behaves in such and such a way (if one knows a thing or two about this behaviour from previous occasions).

So if I *know* that he is happy, then I feel secure, not insecure, in my pleasure. And that, one could say, isn't knowing.--Still it is different if I know that he is seeing what he claims to be seeing.

"I know that he was sincerely pleased to see me."

Page Break 50

II: MS 170

Page 50

(around 1949)

Page Break 51

Page 51

People who don't have the concept 'tomorrow'. They still could have a quite well-developed language: various commands, questions, descriptions. Could we communicate with them?--But could we *describe* to them how people use the word "tomorrow", without teaching it to them? *What purpose* could the description serve?

'Tomorrow' plays such a great role because the change from day to night is so important to us. If it were not... [Cf. *RC* III, 116]

Page 51

If one wanted to give a rough description of the game with "tomorrow", analogously to a rough description of the differential calculus, then it would have to be a lot more primitive, and it would be difficult to imagine a purpose for it.

But think about what concepts people have for curved space.

Page 51

Even if someone's behaviour is very regular in itself, still it is hard for us to grasp this regularity if his behaviour deviates from ours in strange ways. Then one might say "I cannot get used to his...". Consider also that wish creates expectation.

Page 51

The language of someone who as an imbecile lives among normal people and is cared for by them. Perhaps he doesn't know the concept 'tomorrow'. [Cf. *RC* III, 118]

Page 51

Operating with concepts permeates our life. I see some sort of analogy with a very general use of keys. If for instance one always had to open a lock in order to move something.

Page 51

Can the psychologist teach us what seeing is? He doesn't teach us the use of the word 'to see'. Is "seeing" a technical term of psychology? Is "dog" a technical term of zoology?

Page Break 52

Perhaps the psychologist discovers differences among people that are not noticed in everyday life and show up only under experimental conditions. But blindness is not something that the psychologist discovers.

If seeing were something that the psychologist has discovered, then the word "seeing" could only mean a form of behaviour, an ability to act in such and such a way. So if the psychologist were to pronounce "There are people who *see*", then he would have to be able to describe for us the behaviour of these seeing people. But in doing this he would not have taught us the use of the form "I see something red and round", for instance, and more specifically would not have taught this to a sighted person. [a: cf. *RC III*, 337-338]

Page 52

Couldn't a seeing person manage completely without the word "see"? He might say "Over there there is... ". A normal child could manage *for a long time* without the word "see", but not for instance without the words "red", "yellow," "round".

Page 52

If I observe the course of my pains, which sense-impressions am I supposed to have had if I had not been observing? Would I have felt nothing? Or would I only have not remembered?

Page 52

"I wouldn't have seen it if I hadn't observed it."--What do the words "it" refer to? To the same thing?
"I wouldn't have felt the pain if I hadn't observed the pain."
But one can say after all "Observe your pain" and *not* "Feel pain!"

Page 52

Test: "Most chairs do not evaporate."

"If something like that had happened, I certainly would have heard about it."

Page Break 53

To be sure one can also say in this case "It's always been like that, so it will be like that this time too."--But how does one know that it always was that way?

Page 53

The one seems to be supported by the other, but neither obviously serves as the basis for the other.

Page 53

We say "Undoubtedly it is so", and don't know how very much this certainty determines our concepts.

To the question "Did the earth really exist before your birth" we would respond, half annoyed and half embarrassed, "Yes, of course!" All the while we would be conscious that on the one hand we are not at all capable of giving reasons for this because seemingly there are too many, and on the other hand that no doubt is possible, and that one cannot answer the questioner by way of *one* particular piece of instruction, but only by gradually imparting to him a picture of our world.

Page Break 54

III:
MS 171

Page 54

(1949 or 1950)

Page Break 55

Page 55

An inner, in which it looks either like this or like that; we are not seeing it. In my inner it is either red or blue. I know which, no one else does.

Page 55

If pretending were not a complicated pattern, it would be imaginable that a new-born child pretends.

Page 55

Therefore I want to say that there is an original genuine expression of pain; that the expression of pain therefore is not equally connected to the pain and to the pretence.

Page 55

That is: the utterance of pain is not equally connected with the pain and the pretence.

Page 55

The important aspect for us is not†1 that the evidence makes the experience of someone else 'only probable', but rather that we regard precisely these phenomena as evidence for something important.†2

But let's assume that from the very first moment a child was born it could pretend, indeed in such a way that its first utterance of pain is pretence.--We could imagine a suspicious attitude toward a new-born child: but how would we teach it the word "pain" (or "a hurt")? Say in a questioning tone. Then we might view consistent behaviour as proof of genuineness.

Consider that you have to *teach* the child the *concept*. Thus you have to teach it evidence (the law of evidence, so to speak).

Remarkable the concept to which this game of evidence belongs.

Our concepts, judgements, reactions never appear in connection with just a single action, but rather with the whole swirl of human actions.†1

Only I know what I am thinking actually means nothing else than: only I *think* my own thoughts.

Can one imagine people who don't know pretence and to whom one cannot explain it?

Can one imagine people who cannot lie?--What else would these people lack? We should probably also imagine that they cannot make anything up and do not understand things that are made up.

Whoever couldn't pretend also couldn't play a role.

Isn't the difficulty this: the pretence resides in the *intention*? For we could after all *imitate* the behaviour of pain exactly, without pretending.

The capacity to pretend therefore resides in the ability to imitate, or in the ability to have this intention.

But we must assume that a subject can say the words "I am in pain". Therefore it is a matter of having the capacity to intend. Is it possible, for instance, to imagine people who cannot lie because for them a lie would be nothing but a dissonance. I want to imagine a case where people are truthful not as a matter of *morality*, but rather see something *absurd* in a lie. Whoever lies would be viewed as mentally ill.

Or better: Lying or pretending would have to appear to these people as perversity.

Is it correct to say that a fixed smile is actually no smile at all? How does one recognize that it isn't?

Smiling is one mien within a normal range of miens.--But is that an arbitrary determination? This is the way we learn to use the word.

The remark that... is not important to us, but rather the remark that this involved thing is a kind of evidence for us.

Someone groans under anaesthesia or in sleep. I am asked "Is he in pain?" I shrug my shoulders or say "I don't know whether he's in pain". Sometimes I acknowledge something as a criterion for it, but sometimes I don't.

Well, do I mean nothing by this? Oh yes: I am making a move in an existing game. But this game wouldn't exist if there weren't criteria in other cases.

The doubt in the different cases has a different colouring, so to speak.

One might say "a different truth-value".

"I happen to know that this is a sycamore; a sycamore is an external object, therefore there are external objects."

Something turns out to be pain or pretence. And that is essential to the concepts 'pain' and 'pretence', even if it is not evident in every single one of their applications.

Page 57

"Beyond a reasonable doubt." [Cf. *OC* 416, 607]

Page 57

I know... = I am certain that it is so and it is so.

I knew... = I was certain that it is so, and it was so.

Page Break 58

Page 58

I know how it is = I *can* say how it is, and it is as I say it is.

Page 58

A blind person touches an object and asks me "What is that?"--I answer "A table."--He: "Are you certain?"--I: "I *know* it is."

Page 58

"I know..." = I have the highest degree of certainty.

When Moore uses it, then it is as if he wanted to say: "The philosophers are always saying that one can have the feeling of knowing only in this and that case, but *I* have it also in this and this and this case." He looks at his hand, gives himself the feeling of knowing, and now says he has it.

Page 58

What purpose do the statements "He knows" and "I know" serve?

How is it shown that someone knows something? For only if that is clear is the concept of knowing clear.

Page 58

If someone says "Yes, now I know that it is a tree" and if he also says it on the right occasion, then this alone is not yet a sign that he is using the word "know" as we do.

Page 58

"I know that there is a tree here." One can say this for instance when for some reason one wants to repeat his own words (as when one recites a passage from a book by heart). Now how do we know which use you have made of the sentence? You can tell us. It could be the following: I'm thinking of people who say that it is uncertain that..., and now I say "No, it is not uncertain: I *know* that..." (As in "I *know* that he is not deceiving me".) Now, whoever says "I know that that is a tree" in this way means a tree and *not* this or that.

Page Break 59

Page 59

It is true that Moore knows that this is a tree; this shows in his entire behaviour. From this it does not follow that he does not misunderstand the words "I know etc." in philosophizing. He proved his misunderstanding by looking at his hands and saying "I know that these are hands" instead of simply noting "I know an immense number of facts concerning physical objects". And what is more, they are so certain for me that nothing can strengthen or destroy this certainty.

Page 59

What we find remarkable is not that..., rather we are looking at the fact that *this* is evidence for us.

Page 59

"In the inner there is either pain or pretence. On the outside there are signs (behaviour), which don't mean either one with complete certainty."

But that's not the way it is. In an extremely complicated way the outer signs sometimes mean unambiguously, sometimes without certainty: pain, pretence and several other things.†1

Page 59

"Nothing is as common as the colour reddish-green; for nothing is more common than the transition of leaves from green to red."

Page 59

"Believing, knowing, an experience which one recognizes as this very thing†2 while one is having it."†3

Page Break 60

Page 60

IV: MS 173

(1950)

"One knows when someone is really happy." But that doesn't mean that one can describe the genuine expression. But of course it is not *always* true that one recognizes the genuine expression, or knows whether the expression is genuine. Indeed there are cases where one is not happy either with "genuine" or "sham". Someone smiles and his further reactions fit neither a genuine nor a simulated joy. We might say "I don't know my way around with him. It is neither the picture (pattern) of genuine nor of pretended joy."

Mightn't his relation to a person with normal feelings be like that of a colour-blind person to the normal-sighted?

On the basis of my knowledge of his character I could state reliably that he will react in such and such a way in this situation; and it would also be possible that others can rely on my judgement without however being able to demand of me that I support my judgement with a verifiable description.

Let's assume that a painter represented the expression of blissful joy--and I see the picture and say "Maybe she's pretending."

It is at least conceivable that in some country a court relies on a man's statement about what is possible for him, if a witness has known him for a certain length of time. In this way even now one might ask a psychiatrist whether this or that person is capable of suicide. It is assumed in this connection that in general *experience* does not disprove such a statement.

I am trying to describe the laws or rules of evidence for empirical sentences: does one really characterize what is meant by the mental in this way?

The characteristic sign of the mental seems to be that one has to guess at it in someone else using external clues and is

only *acquainted* with it from one's own case.

But when closer reflection causes this view to go up in smoke, then what turns out is not that the inner is something outer, but that "outer" and "inner"†1 now no longer count as properties of evidence.†2 "Inner evidence" means nothing, and therefore neither does "outer evidence".

But indeed there is 'evidence for the inner' and 'evidence for the outer'.

"But all I ever perceive is the *outer*." If that makes sense, it must determine a concept. But why should I not say I perceive his doubts? (*He* cannot perceive them.)

Indeed, often I can describe his inner, as I perceive it, but not his outer.

The connection of inner and outer is part of these concepts. We don't draw this connection in order to magically remove the inner.

There are inner *concepts* and outer *concepts*.

What I want to say is surely that the inner differs from the outer in its *logic*. And that logic does indeed explain the expression "the inner", makes it understandable.†3

We don't need the concept "mental" (etc.) to justify that some of our conclusions are undetermined, etc. Rather this indeterminacy, etc., explains the use of the word "mental" to us.

"Of course actually all I see is the outer."

But am I not really speaking only of the outer? I say, for instance, under what circumstances people say this or that. And I do always mean *outer* circumstances. Therefore it is *as if* I wanted to explain (quasi-define) the inner through the outer. And yet it isn't so.

Page 63

Is the reason for this that the language-game is something outer?

Page 63

No evidence teaches us the psychological utterance.

Page 63

"Mental" for me is not a metaphysical, but a logical, epithet.

Page 63

"I see the outer and imagine an inner that fits it."

Page 63

When mien, gesture and circumstances are unambiguous, then the inner seems to be the outer; it is only when we cannot read the outer that an inner seems to be hidden behind it.

Page 63

There are inner and outer concepts, inner and outer ways of looking at man. Indeed there are also inner and outer facts -just as there are for example physical and mathematical facts. But they do not stand to each other like plants of different species. For what I have said sounds like someone saying: In nature there are all of these facts. Now what's wrong with that?

Page 63

The inner is tied up with the outer not only empirically, but also logically.

Page Break 64

The inner is tied up with the outer logically, and not just empirically.

Page 64

"In investigating the laws of evidence for the mental, I am investigating the *essence* of the mental." Is that true?

Page 64

Yes. The *essence* is not something that can be shown; only its features can be described.

Page 64

But doesn't a prejudice argue against this? To be sure we can little by little enumerate the *properties* of an inkwell, but its *essence*--mustn't it stand fast once and for all, isn't it presented to us with this very object, before our eyes? What we have here in front of us surely isn't the 'use of a word'! Certainly not; but the concept 'inkwell', which is necessary here after all, is not tangibly in front of us, nor does what is in front of us contain this concept. In order to represent it, it is not enough to put an inkwell in someone's hand. And this is not because that person is too lame-brained to read the concept off the object.

Page 64

I can show someone an object because its *colour* stands out and I want to demonstrate *it* to him, but that already presupposes that there is a certain game between us.

Page 64

Indeed he might be astonished when he sees the object, but in order to 'be astonished about the colour', in order for the colour to be the *reason* of his astonishment and not just the *cause* of his experience, he needs not just sight, but to have the concept of colour.

Page 64

Someone says on his word of honour that someone else believed this or that.--At that point one can ask him, "How do you know that", and he can answer "He assured me of this with utmost seriousness, and I know him extremely well".

Page Break 65

If I say "I can't figure him out", this bears little resemblance to: "I can't figure this mechanism out." I think it means *approximately*: I can't foresee his behaviour with the same certainty as with people 'with whom I do know my way about'.

Page 65

The question of evidence for what is experienced has to be connected with the certainty or uncertainty of foreseeing someone else's behaviour. But that's not quite the way it is; for only rarely does one predict someone else's reaction.

Page 65

I think unforeseeability must be *an* essential property of the mental. Just like the endless multiplicity of expression.

Page 65

What for instance speaks for, what against, a dog's having a mental life?

Page 65

Certainly it isn't its shape, colour, or anatomy. So it is its behaviour.

Page 65

Those who say that a dog has no soul support their case by what it can and cannot do. For if someone says that a dog cannot hope--from what does he deduce that? And whoever says that a dog *has* a soul can only support that with the behaviour he observes in the dog.

"Just look at the face and the movements of a dog, and you'll see that it has a soul." But what is it about the face? Is it only the similarity with the play of the features of the human face? Is it, at least among other things, the lack of stiffness?

Page 65

The *important* fine shades of behaviour are not predictable.

Page 65

But does that mean: If they could be foreseen, with a

Page Break 66

human we wouldn't speak of an inner as opposed to an outer?---Are we really imagining this kind of predictability clearly? Does it imply for instance that we wouldn't ask him for a decision?

Page 66

Imagine we were to encounter a human who had no soul. Why shouldn't something like that occur as an abnormality? So a human body would have been born with certain vital functions, but without a soul. Well, what would that look like?

Page 66

The *only* thing I can imagine in that case is that this human body acts like an automaton, and not like normal human bodies.

Page 66

When they say "Man consists of a body and a soul", then this would not be contradicted by such a phenomenon. For then this would be no (real) human, but something else, something very rare to be sure. But how can one know that it *never* happens? Only,--what would this phenomenon actually look like?

Page 66

Or is it supposed not to be a phenomenon at all? Should having a soul not be recognizable at all?

Page 66

Can there be heartlessness that has no expression? Would that be what we call "heartlessness"?

Page 66

One could also put it this way: How would a human body have to act so that one would not be inclined to speak of inner and outer human states?

Again and again, I think: "like a machine".

Page 66

Perhaps language, along with tone of voice and the play of features, is the most subtly gradated behaviour of men.

Page 66

Could the soulless one produce signs of pain? If he only

Page Break 67

screamed and writhed then one could still view this as an automatic reaction, but if he grimaced in pain and had a suffering look, then we would already have the feeling that we were looking *into him*.

But now, what if he always produced exactly the same suffering expression?

Page 67

It is as if he became *transparent* to us through a human facial expression.

Page 67

Anyone with a soul must be capable of pain, joy, grief, etc. etc. And if he is also to be capable of memory, of making decisions, of making a plan for something, with this he needs linguistic expression.

Page 67

It is not as if he had only indirect, while I have internal direct evidence for my mental state. Rather, he has evidence for it, (but) I do not.

Page 67

But if one now says that this evidence makes the mental only probable, that can have many meanings, and

they can be true or false. And it certainly doesn't mean that the evidence is only empirically connected with the mental (like a symptom with an illness).

Page 67

Why shouldn't one say: "The evidence for the mental in someone else is the outer"?

Well, there is no such thing as outer mediated and inner unmediated evidence for the inner.†1

Page 67

And to the extent that the evidence is uncertain, isn't this because it is only outer.

Page 67

That an actor can represent grief shows the uncertainty of evidence, but that he can represent *grief* also shows the reality of evidence.

Page Break 68

It is not the relationship of the inner to the outer that explains the uncertainty of the evidence, but rather the other way around--this relationship is only a picture-like representation of this uncertainty.

Page 68

It isn't only the mental that is represented to us on the stage; we are also given the illusion of a wound, or a mountain.

Page 68

Its being portrayable on the stage†1 is not the sole characteristic of the mental.

Page 68

Why do we say: "I didn't know what went on behind this brow", although it can be of no importance to us whatsoever what goes on behind someone's brow. Our uncertainty doesn't at all refer to what goes on in the inner; and even if it does refer to the mental, the mental finds its expression in the bodily.

So an uncertainty about the outer corresponds to an uncertainty concerning the inner.

Just as an uncertainty about the numeral that will come at the bottom line corresponds to an uncertainty about the number that is the result of a calculation.

Page 68

And that does *not* mean that in general the uncertainty about something mental†2 can be expressed as uncertainty about the outer.

Just as, to be sure, sorrow in its essence has an expression in one's mien, and yet I still may not be able to describe a mien other than by using the word "sorrowful".

Page 68

Could someone state in court: "I know that at that time he thought of..."? Well, this kind of statement could be admitted or not. Perhaps a judgement would be made that

Page Break 69

someone who has known the accused for so many years can deduce from his mien etc. what he thinks in a certain case. But perhaps such a statement wouldn't be admitted at all, and the opinion would be that not even an *utterance* of the accused could be entered as evidence if the only point of doing so is to describe his mental processes.

Page 69

"I can't figure these people out." And why should I want to?--Isn't it their reactions that I can't figure out? That for instance I cannot foresee; that keep on surprising me?

"He seems to react illogically." And that means: inconsequently.

Page 69

If one can't figure out some things this means that one can figure out other things. And sometimes that is expressed by saying one 'could imagine' what goes on in someone else. That sounds as if knowing what goes on in someone else is an *imagining* of this process. For instance if I know that someone hates me then I feel a kind of visual image of that hate. This opinion rests on a host of false ideas. To be sure one uses the words "to imagine someone else's hate (etc.)", and indeed image pictures can play a role here, or perhaps one makes a face like one that is filled with hate.

Page 69

From the outset the language-game is constructed so that a comparison with other language-games can lead to the 'outer-inner' picture. But to this is added the factual uncertainty that is part of guessing†1 someone else's mental processes. For, as has been said, it would be quite possible for this recognizing to be much more certain than it is. Indeed that pretending might take place mainly by *hiding* one's face

Page Break 70

(for instance). That is: pretending would be possible even if one couldn't put on a false face.

Page 70

But it is *not* true that uncertainty in recognizing his irritation (for instance) is simply uncertainty about his future behaviour. Rather in the concept there is an uncertainty of criteria. So sometimes he is transparent, as it were, and sometimes he isn't. And it is misleading to think of the real irritation as a facial expression of an *inner* face, so to speak, such that this facial expression is defined completely clearly, and that it is only the outer face that makes it uncertain whether the soul really has this expression.

Page 70

For even if he himself says without lying that he was a bit irritated, that doesn't mean that he then saw in himself that face that we called 'irritated'. Again we only have a verbal reaction from him, and it is by no means clear how much it *means*. The PICTURE is clear, but not its application.

Page 70

For even when I myself say "I was a little irritated about him" how do I know how to apply these words so precisely? Is it really so clear? Well, they are simply an utterance.

Page 70

But do I not know exactly what I mean by that utterance? "After all, I know exactly what inner state I am calling that." That means nothing. I know how the word is used, and sometimes I make this utterance unhesitatingly, and sometimes I hesitate and say, for instance, that I wasn't *exactly* irritated', or some such thing. But it is not *this* indeterminacy I was speaking of. Even where I say without hesitation that I was irritated, that does not establish how certain the further consequences of this signal are.

Page Break 71

When I said that there is an indeterminacy in the application I didn't mean that I didn't really know when I should utter the expression (as it would perhaps be if I didn't understand English well).

Page 71

One simply mustn't forget *which* connections are made when we learn how to use expressions such as "I am irritated".

Page 71

And don't think of a child's *guessing* the correct meaning, for whether it guessed it *correctly* must in turn be demonstrated in its use of the words.

Page 71

We say: "Let's imagine people who do not know *this* language-game." But in doing so we still have no clear conception of the life of these people in so far as it differs from our own. We do not yet know what we are supposed to imagine; for the life of these people is in all other ways to correspond with ours, and it still must be determined what we would call a life corresponding to ours under these new conditions.

Isn't it as if one said: There are people who play chess without the king? Questions immediately arise: Who wins now, who loses, and others. You have to make *further* decisions that you don't anticipate in that first determination. Just as you also don't have an overview of the original technique, and are only familiar with it from case to case.†1

Page 71

It is also a part of dissembling to regard others as capable of dissembling.

Page Break 72

If human beings act in such a way that we are inclined to suspect them of dissembling, but they show no mistrust of one another, then this doesn't present a picture of people who dissemble.

Page 72

'We cannot help but be constantly surprised by these people.'

Page 72

We could portray certain people on the stage and have them speak in monologues (asides) things that in real life they of course would not say out loud, but which would nevertheless correspond to their thoughts. But we couldn't portray alien humans this way. Even if we could predict their behaviour, we couldn't give them the appropriate asides.

And yet there's also something wrong with this way of looking at it. For someone might actually say

something to himself while he was going about doing things, and this could, for example, be quite conventional.

Page 72

That I can be someone's friend rests on the fact that he has the same *possibilities* as I myself have, or similar ones.

Page 72

Would it be correct to say our concepts reflect our life?

Page 72

They stand in the middle of it.

Page 72

The rule-governed nature of our language permeates our life.

Page 72

Of whom would we say, he doesn't have our concept of pain? I could assume that he knows no pain, but I want to assume that he does know it; we thus assume he gives expressions of pain and we could teach him the words "I have pain". Should he also be capable of remembering his pain?--Should he recognize expressions of pain in others as

Page Break 73

such; and how is this revealed? Should he show pity? Should he understand make-believe pain *as being just that*?

Page 73

"I don't know *how* irritated he was." "I don't know if he was *really* irritated."--Does he know himself? Well, we ask him, and he says, "Yes, I was."

Page 73

What then is this *uncertainty* about whether the other person was irritated? Is it a mental state of the uncertain person? Why should we be concerned with that? It lies in the use of the expression "He is irritated".

Page 73

But *one* is uncertain, another may be certain: he 'knows the look on this person's face' when he is irritated. How does he learn to know this sign of irritation as being such? That's not easy to say.

Page 73

But it is not only: "What does it mean to be uncertain about the state of another person?"--but also: "What does it mean 'to *know*, to be certain, that this person is irritated'?"

Page 73

Here it could now be asked what I really want, to what extent I want to deal with grammar.

Page 73

The certainty that he will visit me and the certainty that he is irritated have something in common. The game of tennis and the game of chess have something in common, too, but no one would say here: "It is very simple: they play in both cases, it's just that each time they play something different." *This* case shows us the dissimilarity to "One time he eats an apple, another time a pear", while in the other case it is not so easy to see.

Page 73

"I know that he arrived yesterday"--"I know that $2 \times 2 = 4$ "--"I know that he had pain"--"I know that there is a table standing there."

Page Break 74

In each case I know, it's only that it's always something different? *Oh yes*,--but the language-games are far more different than these sentences make us conscious of.

Page 74

"The world of physical objects and the world of consciousness." What do I know of *the latter*? What my senses teach me? That is how it is, if one sees, hears, feels, etc. etc. But do I really learn that? Or do I learn what it's like when I now see, hear, etc., and I *believe* that it was also like this before?

Page 74

What actually is the '*world*' of consciousness? There I'd like to say: "What goes on in my mind, what's going on in it now, what I see, hear,..." Couldn't we simplify that and say: "What I am now seeing."

Page 74

The question is clearly: How do we 'compare' physical objects how do we compare experiences?

Page 74

What actually is the '*world of consciousness*'?--That which is in my consciousness: what I am now seeing, hearing, feeling... And what, for example, am I now seeing? The answer to that cannot be: "Well, *all that*", accompanied by a sweeping gesture.

I observe this patch. "Now it is like so"--and simultaneously I point, for example, to a picture. I may constantly *observe* the same thing and what I *see* may then remain the same, or it may change. What I observe and what I see do not have the same (kind of) identity. Because the words "this patch", for example, do not allow us to recognize the (kind of) identity I mean.

"Psychology describes the phenomena of colour-blindness as well as those of normal sight." What are the 'phenomena of colour-blindness'? Certainly the reactions of the colour-blind person which differentiate him from the normal person. But certainly not *all* of the colour-blind person's reactions, for example not those that distinguish him from a

blind person. Can I teach the blind what seeing is, or can I teach this to the sighted? That doesn't mean anything. Then what does it mean: to describe *seeing*? But I can teach human beings the meaning of the words "blind" and "sighted", and indeed the sighted learn them, just as the blind do. Then do the blind know what it is like to see? But do the sighted know? Do they also know what it's like to have consciousness?

But can't psychologists observe the difference between the behaviour of the sighted and the blind? (Meteorologists the difference between rain and drought?) We certainly could, for example, observe the difference between the behaviour of rats whose whiskers had been removed and of those which were not mutilated in this way. And we could call that describing the role of this tactile apparatus.--The lives of the blind are different from those of the sighted.

The normal person can, for instance, learn to take dictation. What is that? Well, one person speaks and the other writes down what he says. Thus, if he says, for example, the sound *a*, the other writes the symbol "a", etc.--Now mustn't someone who *understands* this explanation either already have known the game, only perhaps not by this name,--or have learned it from the description? But Charlemagne certainly understood the principle of writing and still couldn't learn to write.†1 Someone can thus also understand the description of a technique yet not be able to learn it. But there are two cases of not-being-able-to-learn. In the one case we merely fail to gain a certain skill, in the other we lack comprehension. We can *explain* a game to someone: He may understand this explanation, but not be able to learn the game, or he may be incapable of understanding an explanation of the game. But the opposite is conceivable as well.

"You see the tree, the blind do not see it." This is what I would have to say to a sighted person. And so do I have

to say to the blind: "You do not see the tree, we see it"? What would it be like for the blind man to believe that he saw, or for me to believe I couldn't see?

Is it a phenomenon that I see the tree? It is one that I correctly recognize this as a tree, that I am not blind.

"I see a tree", as the expression of the visual impression--is this the description of a phenomenon? Of *what* phenomenon? How can I explain this to someone?

And yet isn't the fact that *I* have this visual impression a phenomenon for someone else? Because it is something that he observes, but not something that I observe.

The words "I am seeing a tree" are not the description of a phenomenon. (I couldn't say, for example, "I am seeing a tree! How strange!", but I could say: "I am seeing a tree, although there's no tree there. How strange!")

Or should I say: "The impression is not a phenomenon; but that L. W. has this impression is one"?

(We could imagine someone talking to himself describing the impression as one does a dream, without using the first person pronoun.)

To observe is not the same thing as to look at or to view.

"Look at this colour and say what it reminds you of." If the colour changes you are no longer looking at the one I meant.

One observes in order to see what one would not see if one did not observe.

Page 76

We say, for example "Look at this colour for a while." But we don't do that in order to *see* more than we would have seen at first glance.

Page Break 77

Could a "Psychology" contain the sentence: "There are human beings who *see*"?

Well, would that be false?--But to whom would this communicate anything? (And I don't just mean: what is being communicated is a long-familiar fact.)

Page 77

Is it a familiar fact to me that I see?

Page 77

We might want to say: If there were no such humans, then we wouldn't have the concept of *seeing*.--But couldn't Martians say something like this? Say by chance the first humans they met were all blind.

Page 77

And how can it be meaningless to say "There are humans who see", if it is not meaningless to say there are humans who are blind?

But the meaning of the sentence "There are humans who see", i.e. its possible use, is not immediately clear at any rate.

Page 77

Couldn't seeing be the *exception*? But neither the blind nor the sighted could *describe* it, except as an ability to do this or that. Including e.g. to play certain language-games; but there we must be careful how we describe these games.

Page 77

If we say "There are humans who see", the question follows: "And what *is* 'seeing'?" And how should we answer it? By teaching the questioner the use of the word "see"?

Page 77

How about this explanation: "There are people who behave like you and me, and not like that man over there, the blind one"?

Page 77

"With your eyes open, you can cross the street and not be run over, etc."

Page Break 78

The logic of *informing*.

Page 78

To say that a sentence which has the form of information has a use, is not yet to say anything about the *kind* of use it has.

Page 78

Can the psychologist inform me what seeing is? What do we *call* "informing someone what seeing is"? It is not the psychologist who teaches me the use of the word "seeing".

Page 78

If the psychologist informs us "There are people who see", we could ask him "And what do you call 'people who see'?" The answer to that would be of the sort "Human beings who react so-and-so, and behave so-and-so under such-and-such circumstances". "Seeing" would be a technical term of the psychologist, which he explains to us. Seeing is then something which he has observed in human beings.

Page 78

We learn to use the expressions "I see...", "he sees...", etc., before we learn to distinguish between seeing and blindness.

Page 78

"There are people who can talk", "I can say a sentence", "I can pronounce the word 'sentence'", "As you see, I am awake", "I am here".

Page 78

There is surely such a thing as instruction in the circumstances under which a certain sentence can be a piece of information. What should I call this instruction?

Page 78

Can I be said to have *observed* that I and other people can go around with our eyes open and not bump into things and that we can't do this with our eyes closed?

Page Break 79

When I tell someone I am not blind, is that an observation? I can, in any case, convince him of it by my behaviour.

Page 79

A blind man could easily find out whether I am blind too; by, for example, making a certain gesture with his hand, and asking me what he did.

Page 79

Couldn't we imagine a tribe of blind people? Couldn't it be capable of surviving under certain circumstances? And couldn't sighted people occur as exceptions?

Page 79

Suppose a blind man said to me: "You can go about without bumping into anything, I can't"--would the first part of that sentence transmit a piece of information?

Page 79

Well, he's not telling me anything new.

Page 79

There seem to be propositions that have the character of experiential propositions, but whose truth is unassailable for me. That is to say, if I assume that they are false, I must mistrust all my judgements.

Page 79

There are, in any case, errors which I take to be commonplace and others that have a different character and which must be set completely apart from the rest of my judgements as temporary *confusions*. But aren't there transitional cases between these two?

Page 79

If we introduce the concept of knowing into this investigation, it will be of no help; because knowing is not a psychological state whose special characteristics explain all kinds of things. On the contrary, the special logic of the concept "knowing" is not that of a psychological state.

Page Break 80

V: MS 174

Page 80

(1950)

Page Break 81

Page 81

The utterance of pain is not connected equally with pain and with pretence.

Page 81

Pretending is not as simple a concept as being in pain. [Cf. *LW I*, 876]

Page 81

Remember that you have to *teach* a child the *concept*. Therefore you have to teach it the game of evidence.

Page 81

That our evidence makes someone else's experience only probable doesn't take us far; but that this pattern of our experience that is hard to describe is an important piece of evidence for us does. †1

Page 81

That this fluctuation is an important part of our life.

But how can one say at all that it is something *fluctuating*? Against what do I measure its fluctuation? Well, there are countless configurations of smiling, for instance. And smiling that is smiling, and smiling that is not.

Page 81

What do we take note of in life?--"... He smiled at that point."--that can be infinitely important. But does a small distortion of the face *have* to be important? And does it have to be so for us because of the probable practical consequences?

Page 81

"He *cannot* know what's going on within me." But he can surmise it. So the only thing he can't do is *know* it. Therefore we are only making a distinction in the use of the word "know".

Page 81

But does an astronomer who calculates a lunar eclipse say that of course one cannot *know* the future? We express ourselves in this way when we feel uncertain about the future. The farmer says it about the weather; but the carp

Page Break 82

enter doesn't (say) that one cannot know whether his chairs will collapse.

Page 82

"I know that he was glad to see me." *What* do I know? What consequences does this fact have? I feel certain in my dealings with him. But is that knowing?

But what is the difference between surmising and knowing that he was glad?

If I know it I'll assert it without signs of doubt, and others will understand this statement. Well yes, it does have certain practical consequences; in a pinch something can be deduced from it, but that seems merely to be its shadow.

What is the interest of his inner state of gladness?

Page 82

If I believe that he was glad and find out later that this was not so, what consequences does *that* have?

Page 82

What difference does it make if at first I believe that he was glad and then realize that it wasn't true?

Page 82

We would like to project everything into his inner. We would like to say that *that's* what it's all about. For in this way we evade the difficulty of describing the *field* of the sentence.†1

Page 82

It's exactly as if one said that "Benzene has the structure <image>" means: the atoms are arranged *in this way*.

Page 82

But why do I say that I 'project' everything into the inner? Doesn't it reside in the inner? No. It doesn't *reside* in the inner, it *is* the inner. And that is only a *superficial* logical classification and not the description we need.

Page Break 83

We '*project*' nothing into his inner; we just give an explanation that doesn't get us any further.

Page 83

Imagine that the soul is a face, and when someone is glad this hidden face smiles. Let it be this way--but now we still want to know what importance this smile (or whatever the facial expression is) has.

Page 83

Indeed this could even be our regular expression: "His inner face smiled when he saw me", etc.

Page 83

First question: How does one know, how does one judge, whether his inner face is smiling? Second question: What importance does it have?---But both are connected. And one could ask *another*, although related, question: What importance does his--*outer*--smile have? For if the inner is of importance, then--in a (somewhat) different way--so must the outer be.

Page 83

(It is not easy to realize that my manipulations are justified.)

Page 83

But if "I know that he was glad" *certainly* does *not* mean: I know that he smiled, then it is something else that I know and that is important here.

Page 83

For under certain circumstances the inner smile could replace an outer one, and the question about the *meaning* would (still) remain unanswered.

Page 83

"I'm certain that he was glad to see me"; this could be stated in a court of law. Here the possible 'practical' consequences are clear. And this would be equally the case if the statement were "I am certain that he was not happy, but that he was pretending". One thing is to be expected of someone who is glad, another of him who feigns gladness.

Page Break 84

But is the fact that someone else is really glad to see me important to me because it has different consequences? I am comfortable when *this* person (with *this* past etc.) behaves *in this way*. And the '*in this way*' is a very complicated pattern, to be sure.

If one doesn't want to SOLVE philosophical problems why doesn't one give up dealing with them. For solving them means changing one's point of view, the old way of thinking. And if you don't want that, then you should consider the problems unsolvable.

It's always presupposed that the one who smiles *is* a human being and not just that what smiles is a human body. Certain circumstances and connections of smiling with other forms of behaviour are also presupposed. But when all that has been presupposed someone else's smile is pleasing to me.

If I ask someone on the street for directions then I prefer a friendly answer to an unfriendly one. I react immediately to someone else's behaviour. I presuppose the *inner* in so far as I presuppose a *human being*.

The 'inner' is a delusion. That is: the whole complex of ideas alluded to by this word is like a painted curtain drawn in front of the scene of the actual word use.

It seems to me: if one can't really *know* whether someone is (for instance) irritated, then one also cannot really believe or surmise it.

Isn't it true that whatever I can 'be certain of' I can also 'know'?

Wouldn't it be ridiculous if a lawyer in court were to say

that a witness couldn't *know* that someone had been angry, because anger is something inner?--Then one also cannot know whether hanging is punishment.

Whoever says "one cannot know *that*" makes a distinction between language-games. He says: In *such* language-games knowing exists, in *such* it doesn't, and in doing so he limits the concept 'knowing'.

This limitation could be useful if it emphasizes an important difference that is passed over by our ordinary use of language. But I believe that that is not the way it is.

But isn't mathematical certainty greater than any physical certainty, to say nothing of the certainty about what someone else feels?

And can't the greater certainty of mathematics simply be expressed this way: There is knowing in mathematics?

In mathematics a particular kind of evidence that can be clearly presented leaves no doubt open. That is not the way it is when we know that someone was glad.

There can't be a long dispute in a court of law about whether a calculation has this or that result; but there certainly can be about whether someone was irritated or not.

But does it follow that one can know the one and not know the other? More likely what follows is that in the one case one almost always knows the decision, in the other, one *frequently* doesn't.

If one says that one never knows whether someone else really felt this way or that, then that is not because perhaps after all he really felt differently, but because even God so to speak cannot *know* that the person felt that way.

I am for instance convinced that my friend was glad to see me. But now, in philosophizing, I say to myself that it could after all be otherwise; maybe he was just pretending. But then I immediately say to myself that, even if he himself were to admit this, I wouldn't be at all certain that he isn't mistaken in thinking that he knows himself. Thus there is an indeterminacy in the entire game.

One could say: In a game in which the rules are indeterminate one *cannot* know who has won and who has lost.

There is a 'why' to which the answer permits no predictions. That's the way it is with animistic explanations,

for instance. Many of Freud's explanations, or those of Goethe in his theory of colours, are of this kind. The explanation gives us an analogy. And now the phenomenon no longer stands alone; it is connected with others, and we feel reassured.

Page 86

If someone 'pretends friendship and then finally shows his true feelings, or confesses', we normally don't think of doubting this confession† I in turn, and of also saying that we cannot know what's really going on inside him. Rather, *certainty* now seems to be achieved.

Page 86

This is important: I might know from certain signs and from my knowledge of a person that he is glad, etc. But I cannot describe my observations to a third person and--even if he trusts them--thereby convince him of the genuineness of that gladness, etc.

Page 86

One says of an expression of feeling: "It looks genuine". And what meaning would that have were there not *convincing* criteria for genuineness? "That seems genuine" only makes sense if there is a "That is genuine".

Page Break 87

"This weeping gives the impression of being genuine"--so there is such a thing as *genuine* weeping. So there is a criterion for it. "But no *certain one!*"

Page 87

How does someone who accepts a criterion as certain differ from someone who doesn't?

Page 87

But does accepting no criterion as certain mean: never being certain that someone else feels this or that way? Can I be not quite certain and yet accept no criterion as certain? I am (behave) certain, but for instance I don't know *why*.

Page 87

What would it look like if everyone were always uncertain about everyone else's feelings? Seemingly when they are expressing sympathy, etc., for someone, they would always be a little doubtful, would always put on a doubtful expression or make a doubtful gesture.--But if we now leave off this *constant* gesture *because* it is constant, what behaviour then remains? Perhaps a behaviour that is cool, only superficially interested? But then we in turn don't have to interpret their behaviour as an expression of doubting. So it means nothing to say *everyone always...*

Page 87

There is uncertainty and there is certainty; but from this it does not follow that there are criteria that are certain.

Page 87

How would it be if someone were now to say: "I know that he is glad" means merely that I am certain of his gladness, and therefore also that *I* am reacting to him in such and such a way and, what is more, without uncertainty. Then it would be approximately like "I know that everything is for the best"--the expression of the position taken towards whatever comes along. And here there would be grounds for saying that this is not really knowledge. But the latter statement would convince no one, not even in a court of law, that everything is for the best.

Page Break 88

And here there is something important: The statement "I know that he is glad" would after all, even in a court of law, not count for more than: "I have the certain impression that he is glad." It would not be the same as if a physicist stated that he did this experiment and that *this* was the result; or as if a mathematician made a statement about a calculation.--If I have known the other person a long time, the court will probably also allow my statement to stand, will attach importance to it. But my absolute certainty will not mean *knowing* to the court. For if it were knowing, the court would have to be able to draw certain well-defined conclusions.

Page 88

And one cannot answer: "*I* draw certain conclusions from my knowledge, even if no one else can"--for *conclusions* must be valid for all.

Page 88

Here the connection of evidence with what it is evidence for is not ineluctable. And I *don't* mean: "the connection of the outer with the inner".

Page 88

One could even say: The uncertainty about the inner is an uncertainty about something outer.

Page 88

If "I know..." means: I can convince someone else if he believes my evidence, then one can say: I may well be as certain about his mood as about the truth of a mathematical proposition, but it is still false to say that I *know* his mood.

(But it is still false to say: Knowing is a different mental state from being certain. (I is a different person from L. W.))

Page 88

That is: 'knowing' is a psychological concept of a different kind from 'being certain', 'being convinced', 'believing', 'surmising', etc. The evidence for knowing is of a different kind.

Page Break 89

Russell's example: "I know that the present Prime Minister is bald"; the person who says this is certain just because he wrongly believes that X is Prime Minister; nevertheless the actual present Prime Minister is also bald and so the *assertion* is true and all the same the person doesn't *know* that it is.

Page 89

"I *know* that it is so" is to be sure an expression of my complete certainty, but, besides my being certain, other things follow from it.

Page 89

In the first place, "I cannot know his feelings" does *not* mean:... as opposed to *mine*. In the second place, it does not mean: I can never be completely sure of his feelings.

Page 89

Statement: "I know that the bottle was standing there."--"How do you know that?"--"I saw it there."---If the statement is: "I know that he was glad", and the question is asked: "How do you know that?" what is the answer? It is not simply the description of a physical state of affairs. Part of it is for instance that I know the person. If a film could be shown in the courtroom in which the whole scene were rendered--the play of his facial expressions, his gestures, his voice--sometimes this could have a fairly convincing effect. At least if he is not an actor. But it only has an effect for instance if those judging the scene belong to the same culture. I wouldn't know, for instance, what genuine gladness looks like with Chinese.

Page 89

Rather than directing our attention to the fact that one cannot *know* what someone else experiences, that an experience is in some sense the secret of the person who has it, we direct it instead to any and all rules of evidence that refer to experiences.

Page 89

It's important, for instance, that one must '*know*' someone in order to be able to judge what meaning is to be attributed

Page Break 90

to one of his expressions of feeling, and yet that one cannot describe what it is that one knows about him.

It is just as important that one cannot say what the essential observable consequences of an inner condition are. If for instance he really was glad, what can be expected from him, and what not? Of course there are such characteristic consequences, but they cannot be described in the same way as the reactions that characterize the state of a physical object.

Page 90

This must also be considered: Genuineness and falseness are not the only essential characteristics of an expression of feeling. One cannot tell, for instance, whether a cat that purrs and then right away scratches someone was pretending. It could be that someone uttered signs of gladness and then behaved in a completely unexpected way, and that we still could not say that the first expression was not genuine.

Page 90

It seems to me as little a fact that there can only be genuine or feigned expressions of feeling as that there can only be major or minor keys.

Page Break 91

VI: MS 176

Page 91

(1951)

"Can one know what goes on in someone else in the same way he himself knows it?"----Well, how does he know it? He can express his experience. No doubt within him whether he is really having this experience--analogous to the doubt whether he really has this or that disease--comes into play; and therefore it is wrong to say that he knows what he is experiencing. But someone else can very well doubt whether that person has this experience. Thus doubt does come into play, but, precisely for that reason, it is also possible that there is complete certainty.†1

Need I be less certain that someone is suffering pain than that $12 \times 12 = 144$?

And yet sometimes one says that one cannot know that. Well, above all, one can't prove it. That is, there is nothing here of the sort of proof that rests on (generally) known principles.

But that which is in him, how can I see it? Between his experience and me there is always the expression! Here is the picture: He sees it immediately, I only mediately. But that's not the way it is. He doesn't see something and describe it to us.

If 'something is going on inside him', then to be sure I don't see it, but who knows whether he himself sees it.---

Don't I really often see what is going on inside him?--"Yes, but not in the way in which he himself perceives it. I see that he is in pain, but don't feel any pain. And if I felt pain, it wouldn't be his." This means nothing.--On the other hand it would be conceivable that a connection could be established with someone else through which I would feel the same pain (i.e. the same kind of 'pain'), and in the same place, as the other person. But that this is the case

would have to be ascertained through both people's expression of pain.

And if this way of getting to know someone else's pain were to have proved its worth, it's conceivable that one would apply it against a person's expression of pain, and thus would mistrust his expression if it contradicted that test.

And now one can also imagine that there are people who follow that method *from the outset*, and call *that* "pain" which is ascertained by means of it. In that case their concept 'pain' will be related to ours, but different from it. (Of course it doesn't matter whether they call their concept by the same name as we use for our related one; it only matters that in their life it is analogous to our concept of pain.)

This analogue of our concept would then lack that uncertainty of evidence in ours. In *this* respect our concepts would not be similar.

(If we call that analogous concept 'pain', then these people can believe that they are in pain and also doubt it. But if someone were to say: "Well, in that case there simply is no essential similarity between the concepts"--then we can respond: Here there are immense differences, but also great similarities.)

One could imagine that a kind of thermometer is used to ascertain whether someone is in 'pain'. If someone screams or groans, then they insert the thermometer and only when the gauge reaches this or that point do they begin to feel sorry for the suffering person, and treat him as we do someone who 'obviously is in pain'.

Is the indeterminacy of the logic of the concept of pain connected with the actual absence of certain physical possibilities of reading thoughts and feelings?----If that's a causal question--how can I answer it?

Actually the question could be phrased in this way: How does what is *important* for us depend on what is physically possible?

Where measuring is not important we don't measure, even if we are *able to*.

"Is†1 the impossibility of knowing what goes on in someone else physical or logical? And if it is both--how do the two hang together?"

For a start: possibilities for exploring someone else could be imagined which don't exist in reality. Thus there is a physical impossibility.

The logical impossibility lies in the lack of exact rules of evidence. (Therefore we sometimes express ourselves in this way: "We may always be wrong; we can never be certain; what we observe can *still* be pretence." Although pretence is only one of many possible causes of a false judgement.)---We can imagine an arithmetic in which problems with small numbers can be solved with certainty, but in which the results become less certain the larger the numbers are. So that people who possess this art of calculating state that one can never be completely certain of the product of two large numbers, and that neither could a borderline be given between small and large numbers.

But of course it isn't true that we are never certain about the mental processes in someone else. In countless cases we are.

And now the question remains whether we would give up our language-game which rests on 'imponderable evidence' and frequently leads to uncertainty, if it were possible to exchange it for a more exact one which by and large would have similar consequences. For instance, we could work with a mechanical "lie detector" and redefine a lie as that which causes a deflection on the lie detector.

So the question is: Would we change our way of living if this or that were provided for us?--And how could I answer that?

FOOTNOTES

†1 "non & ne" appear to be an addition in the manuscript.

†2 This remark is preceded by an arrow: ←.

†1 The sentence is obviously incomplete. "Has" is an editor's surmise.

†1 These variants seem to be connected with the remark "I hear that someone is painting..."

†1 Var.: "the illness".

†1 Unclear in the MS.

†1 Var.: "my ego believes".

†1 Var.: "One would have to fill out the picture with behaviour indicating that two...".

†1 Variants: "I seem to have to occupy myself with the object."/"I have to occupy myself with the object."

†1 Var.: "--is that a special kind of seeing? Is it a seeing and thinking? A melding of both--as one is almost tempted to say? The question is: *Why* does one want to say that? Well, if one asks in *this* way it is not very difficult to answer."--An arrow at the end of the remark shows that it is connected to the following remark.

†1 The sentence is obviously incomplete. In the manuscript paragraph b originally read, and was then partially crossed out: "'The word (in the poem) is like the fitting picture of what it means'---".

†1 The sentence seems to be incomplete.

†1 Var.: "in the mind".

†2 Var.: "is a lying open to view."

Page 22

†1 Var.: "in the sentence".

Page 22

†2 Variants: "that exists before all truth or falsity."/"that exists whether it is true or false."

Page 23

†1 Var.: "inner process".

Page 23

†2 Var.: "correspondingly, or almost correspondingly,"

Page 23

†3 Var.: "Heap of sand".

Page 23

†4 Var.: "will".

Page 23

†5 Several variants.

Page 24

†1 The paragraphs appear as individual remarks in the manuscript, but an arrow indicates that they are intended as *one* remark.

Page 25

†1 Var.: "know".

Page 26

†1 The sentence is incomplete.

Page 27

†1 Var.: "This very special pattern in the convoluted drawing of human life."

Page 27

†2 Var.: "Dissimulation plays the same role with them as does walking on all fours with us."

Page 35

†1 At this point in the manuscript there is the following drawing:



How this drawing is connected with the text is not clear to us. In the margin of the page there is also a drawing of a human face.

Page 38

†1 Var.: "of a use and an expression".

Page 39

†1 In the manuscript there are drawings that are probably not connected with this remark.

Page 41

†1 The sentence is incomplete, and the entire remaining page of the manuscript is empty.

Page 42

†1 Life patterns.

Page 43

†1 Var.: "our will".

Page 49

†1 Remark crossed out.

Page 49

†2 Var.: "one of course is never certain".

Page 55

†1 Numerous variants.

Page 55

†2 Var.: "that we see precisely this that is difficult to describe as evidence, as evidence of something important."

Page 56

†1 Remark crossed out.

Page 59

†1 Var.: "In an involved way, the outer signs refer, sometimes with certainty, sometimes without, to pain, or dissimulation, or neither."

Page 59

†2 Var.: "as believing or knowing".

Page 59

†3 Var.: "which one recognizes as whatever it is while one has it."

Page 62

†1 Variants: "outward" and "inward".

Page 62

†2 Var.: "then to be sure the inner has not become the outer, but for us direct inner and indirect outer evidence of the mental no longer exist."

Page 62

†3 Var.: "explain the picture from inside and outside, makes it understandable."

Page 67

†1 Several variants.

Page 68

†1 Var.: "That it can be portrayed to us as an illusion."

Page 68

†2 Var.: "inner".

Page 69

†1 Var.: "recognizing".

Page 71

†1 This and the following remarks have been published in *Remarks on Colour* (III, remarks 296-350), ed. G.E.M. Anscombe (Blackwell, 1977). Here we have omitted one remark (no. 317, pp. 58-9, in *Remarks on Colour*) which has already been published in *Culture and Value*.

Page 75

†1 See *Culture and Value*, 2nd edn, p. 75.

Page 81

†1 This remark is dated 24.4.50.

Page 82

†1 Var.: "to give an account of the *field* of the statement."

Page 86

†1 Var.: "this evidence".

Page 92

†1 Date on the previous page of the MS: "April 14 <51>".

Page 94

†1 Date "April 15<51>".

ON CERTAINTY

Page i



Page Break ii

Title page

Page ii

LUDWIG WITTGENSTEIN: ON CERTAINTY

Edited by
G. E. M. ANSCOMBE
and
G. H. von WRIGHT

Translated by
DENIS PAUL
and
G. E. M. ANSCOMBE



Page Break iii

Copyright page

Page iii

Copyright © Blackwell Publishers Ltd 1969, 1975

First published 1969
Reprinted with corrections and indices 1974
First published in paperback 1975
Reprinted 1977, 1979, 1984, 1988, 1989, 1993, 1994, 1995, 1997, 1998

Blackwell Publishers Ltd
108 Cowley Road
Oxford OX4 1JF, UK

All rights reserved. Except for the quotation of short passages for the purposes of criticism and review, no part of this publication may be reproduced, stored in a retrieval system, or transmitted, in any form or by any means, electronic, mechanical, photocopying, recording or otherwise, without the prior permission of the publisher.

Except in the United States of America, this book is sold subject to the condition that it shall not, by way of trade or otherwise, be lent, re-sold, hired out, or otherwise circulated without the publisher's prior consent in any form of binding or cover other than that in which it is published and without a similar condition including this condition being imposed on the subsequent purchaser.

British Library Cataloguing in Publication Data
A CIP catalogue record for this book is available from the British Library

ISBN 0-631-16940-7 (Pbk)

Printed and bound in Great Britain by Athenæum Press Ltd, Gateshead, Tyne & Wear

This book is printed on acid-free paper

Page Break iv

PREFACE

Page iv

What we publish here belongs to the last year and a half of Wittgenstein's life. In the middle of 1949 he visited the United States at the invitation of Norman Malcolm, staying at Malcolm's house in Ithaca. Malcolm acted as a goad to his interest in Moore's 'defence of common sense', that is to say his claim to *know* a number of propositions for sure, such as "Here is one hand, and here is another", and "The earth existed for a long time before my birth", and "I have never been far from the earth's surface". The first of these comes in Moore's 'Proof of the External World'. The two others are in his 'Defence of Common Sense'; Wittgenstein had long been interested in these and had said to Moore that this was his best article. Moore had agreed. This book contains the whole of what Wittgenstein wrote on this topic from that time until his death. It is all first-draft material, which he did not live to excerpt and polish.

Page iv

The material falls into four parts; we have shown the divisions at § 65, p. 10, § 192, p. 27 and § 299, p. 38. What we believe to be the first part was written on twenty loose sheets of lined foolscap, undated. These Wittgenstein left in his room in G. E. M. Anscombe's house in Oxford, where he lived (apart from a visit to Norway in the autumn) from April 1950 to February 1951. I (G. E. M. A.) am under the impression that he had written them in Vienna, where he stayed from the previous Christmas until March; but I cannot now recall the basis of this

impression. The rest is in small notebooks, containing dates; towards the end, indeed, the date of writing is always given. The last entry is two days before his death on April 29th 1951. We have left the dates exactly as they appear in the manuscripts. The numbering of the single sections, however, is by the Editors.

Page iv

It seemed appropriate to publish this work by itself. It is not a selection; Wittgenstein marked it off in his notebooks as a separate topic, which he apparently took up at four separate periods during this eighteen months. It constitutes a single sustained treatment of the topic.

G. E. M. Anscombe
G. H. von Wright

Page Break 1

ACKNOWLEDGMENT

Page 1

Dr. Lotte Labowsky and Dr. Anselm Müller are to be sincerely thanked for advice about the translation of this work.

Page Break 2

[On Certainty: Main Body]

Page 2

1. If you do know that *here is one hand*,†1 we'll grant you all the rest.

When one says that such and such a proposition can't be proved, of course that does not mean that it can't be derived from other propositions; any proposition can be derived from other ones. But they may be no more certain than it is itself. (On this a curious remark by H. Newman.)

Page 2

2. From its *seeming* to me--or to everyone--to be so, it doesn't follow that it *is* so.

What we can ask is whether it can make sense to doubt it.

Page 2

3. If e.g. someone says "I don't know if there's a hand here" he might be told "Look closer".--This possibility of satisfying oneself is part of the language-game. Is one of its essential features.

Page 2

4. "I know that I am a human being." In order to see how unclear the sense of this proposition is, consider its negation. At most it might be taken to mean "I know I have the organs of a human". (E.g. a brain which, after all, no one has ever yet seen.) But what about such a proposition as "I know I have a brain"? Can I doubt it? Grounds for *doubt* are lacking! Everything speaks in its favour, nothing against it. Nevertheless it is imaginable that my skull should turn out empty when it was operated on.

Page 2

5. Whether a proposition can turn out false after all depends on what I make count as determinants for that proposition.

Page 2

6. Now, can one enumerate what one knows (like Moore)? Straight off like that, I believe not.--For otherwise the expression "I know" gets misused. And through this misuse a queer and extremely important mental state seems to be revealed.

Page 2

7. My life shews that I know or am certain that there is a chair over there, or a door, and so on.--I tell a friend e.g. "Take that chair over there", "Shut the door", etc. etc.

Page Break 3

Page 3

8. The difference between the concept of 'knowing' and the concept of 'being certain' isn't of any great importance at all, except where "I know" is meant to mean: I *can't* be wrong. In a law-court, for example, "I am certain" could replace "I know" in every piece of testimony. We might even imagine its being forbidden to say "I know" there. (A passage in *Wilhelm Meister*, where "You know" or "You knew" is used in the sense "You were certain", the facts being different from what he knew.)

Page 3

9. Now do I, in the course of my life, make sure I know that here is a hand--my own hand, that is?

Page 3

10. I know that a sick man is lying here? Nonsense! I am sitting at his bedside, I am looking attentively into his

face.--So I don't know, then, that there is a sick man lying here? Neither the question nor the assertion makes sense. Any more than the assertion "I am here", which I might yet use at any moment, if suitable occasion presented itself. Then is " $2 \times 2 = 4$ " nonsense in the same way, and not a proposition of arithmetic, apart from particular occasions? " $2 \times 2 = 4$ " is a true proposition of arithmetic--not "on particular occasions" nor "always"--but the spoken or written sentence " $2 \times 2 = 4$ " in Chinese might have a different meaning or be out and out nonsense, and from this is seen that it is only in use that the proposition has its sense. And "I know that there's a sick man lying here", used in an *unsuitable* situation, seems not to be nonsense but rather seems matter-of-course, only because one can fairly easily imagine a situation to fit it, and one thinks that the words "I know that..." are always in place where there is no doubt, and hence even where the expression of doubt would be unintelligible.

Page 3

11. We just do not see how very specialized the use of "I know" is.

Page 3

12. --For "I know" seems to describe a state of affairs which guarantees what is known, guarantees it as a fact. One always forgets the expression "I thought I knew".

Page 3

13. For it is not as though the proposition "It is so" could be inferred from someone else's utterance: "I know it is so". Nor from the utterance together with its not being a lie.--But can't I infer "It is so" from my own utterance "I know etc."? Yes;

Page Break 4

and also "There is a hand there" follows from the proposition "He knows that there's a hand there". But from his utterance "I know..." it does not follow that he does know it.

Page 4

14. That he does know remains to be shewn.

Page 4

15. It needs to be *shewn* that no mistake was possible. Giving the assurance "I know" doesn't suffice. For it is after all only an assurance that I can't be making a mistake, and it needs to be *objectively* established that I am not making a mistake about *that*.

Page 4

16. "If I know something, then I also know that I know it, etc." amounts to: "I know that" means "I am incapable of being wrong about that". But whether I am so must admit of being established objectively.

Page 4

17. Suppose now I say "I'm incapable of being wrong about this: that is a book" while I point to an object. What would a mistake here be like? And have I any *clear* idea of it?

Page 4

18. "I know" often means: I have the proper grounds for my statement. So if the other person is acquainted with the language-game, he would admit that I know. The other, if he is acquainted with the language-game, must be able to imagine *how* one may know something of the kind.

Page 4

19. The statement "I know that here is a hand" may then be continued: "for it's *my* hand that I'm looking at". Then a reasonable man will not doubt that I know. Nor will the idealist; rather he will say that he was not dealing with the practical doubt which is being dismissed, but there is a further doubt *behind* that one.--That this is an *illusion* has to be shewn in a different way.

Page 4

20. "Doubting the existence of the external world" does not mean for example doubting the existence of a planet, which later observations proved to exist.--Or does Moore want to say that knowing that here is his hand is different in kind from knowing the existence of the planet Saturn? Otherwise it would be possible to point out the discovery of the planet Saturn to the doubters and say that its existence has been proved, and hence the existence of the external world as well.

Page Break 5

Page 5

21. Moore's view really comes down to this: the concept 'know' is analogous to the concepts 'believe', 'surmise', 'doubt', 'be convinced' in that the statement "I know..." can't be a mistake. And if that *is* so, then there can be an inference from such an utterance to the truth of an assertion. And here the form "I thought I knew" is being overlooked.--But if this latter is inadmissible, then a mistake in the *assertion* must be logically impossible too. And anyone who is acquainted with the language-game must realize this--an assurance from a reliable man that he *knows*

cannot contribute anything.

Page 5

22. It would surely be remarkable if we had to believe the reliable person who says "I can't be wrong"; or who says "I am not wrong".

Page 5

23. If I don't know whether someone has two hands (say, whether they have been amputated or not) I shall believe his assurance that he has two hands, if he is trustworthy. And if he says he *knows* it, that can only signify to me that he has been able to make sure, and hence that his arms are e.g. not still concealed by coverings and bandages, etc. etc. My believing the trustworthy man stems from my admitting that it is possible for him to make sure. But someone who says that perhaps there are no physical objects makes no such admission.

Page 5

24. The idealist's question would be something like: "What right have I not to doubt the existence of my hands?" (And to that the answer can't be: I *know* that they exist.) But someone who asks such a question is overlooking the fact that a doubt about existence only works in a language-game. Hence, that we should first have to ask: what would such a doubt be like?, and don't understand this straight off.

Page 5

25. One may be wrong even about "there being a hand here". Only in particular circumstances is it impossible.--"Even in a calculation one can be wrong--only in certain circumstances one can't."

Page 5

26. But can it be seen from a *rule* what circumstances logically exclude a mistake in the employment of rules of calculation?

What use is a rule to us here? Mightn't we (in turn) go wrong in applying it?

Page Break 6

Page 6

27. If, however, one wanted to give something like a rule here, then it would contain the expression "in normal circumstances". And we recognize normal circumstances but cannot precisely describe them. At most, we can describe a range of abnormal ones.

Page 6

28. What is 'learning a rule'?--*This*.

What is 'making a mistake in applying it'?--*This*. And what is pointed to here is something indeterminate.

Page 6

29. Practice in the use of the rule also shews what is a mistake in its employment.

Page 6

30. When someone has made sure of something, he says: "Yes, the calculation is right", but he did not infer that from his condition of certainty. One does not infer how things are from one's own certainty.

Certainty is *as it were* a tone of voice in which one declares how things are, but one does not infer from the tone of voice that one is justified.

Page 6

31. The propositions which one comes back to again and again as if bewitched--these I should like to expunge from philosophical language.

Page 6

32. It's not a matter of *Moore's* knowing that there's a hand there, but rather we should not understand him if he were to say "Of course I may be wrong about this". We should ask "What is it like to make such a mistake as that?"--e.g. what's it like to discover that it was a mistake?

Page 6

33. Thus we expunge the sentences that don't get us any further.

Page 6

34. If someone is taught to calculate, is he also taught that he can rely on a calculation of his teacher's? But these explanations must after all sometime come to an end. Will he also be taught that he can trust his senses--since he is indeed told in many cases that in such and such a special case you *cannot* trust them?

Rule and exception.

Page 6

35. But can't it be imagined that there should be no physical objects? I don't know. And yet "There are physical objects" is nonsense. Is it supposed to be an empirical proposition?

Page Break 7

And is *this* an empirical proposition: "There seem to be physical objects"?

36. "A is a physical object" is a piece of instruction which we give only to someone who doesn't yet understand either what "A" means, or what "physical object" means. Thus it is instruction about the use of words, and "physical object" is a logical concept. (Like colour, quantity,...) And that is why no such proposition as: "There are physical objects" can be formulated.

Yet we encounter such unsuccessful shots at every turn.

37. But is it an adequate answer to the scepticism of the idealist, or the assurances of the realist, to say that "There are physical objects" is nonsense? For them after all it is not nonsense. It would, however, be an answer to say: this assertion, or its opposite is a misfiring attempt to express what can't be expressed like that. And that it does misfire can be shewn; but that isn't the end of the matter. We need to realize that what presents itself to us as the first expression of a difficulty, or of its solution, may as yet not be correctly expressed at all. Just as one who has a just censure of a picture to make will often at first offer the censure where it does not belong, and an *investigation* is needed in order to find the right point of attack for the critic.

38. Knowledge in mathematics: Here one has to keep on reminding oneself of the unimportance of the 'inner process' or 'state' and ask "Why should it be important? What does it matter to me?" What is interesting is how we *use* mathematical propositions.

39. *This* is how calculation is done, in such circumstances a calculation is *treated* as absolutely reliable, as certainly correct.

40. Upon "I know that here is my hand" there may follow the question "How do you know?" and the answer to that presupposes that *this* can be known in *that* way. So, instead of "I know that here is my hand", one might say "Here is my hand", and then add *how* one knows.

41. "I know where I am feeling pain", "I know that I feel it *here*" is as wrong as "I know that I am in pain". But "I know where you touched my arm" is right.

42. One can say "He believes it, but it isn't so", but not "He knows it, but it isn't so". Does this stem from the difference between the mental states of belief and of knowledge? No.--One may for example call "mental state" what is expressed by tone of voice in speaking, by gestures etc. It would thus be *possible* to speak of a mental state of conviction, and that may be the same whether it is knowledge or false belief. To think that different states must correspond to the words "believe" and "know" would be as if one believed that different people had to correspond to the word "I" and the name "Ludwig", because the concepts are different.

43. What sort of proposition is this: "We *cannot* have miscalculated in $12 \times 12 = 144$ "? It must surely be a proposition of logic.--But now, is it not the same, or doesn't it come to the same, as the statement $12 \times 12 = 144$?

44. If you demand a rule from which it follows that there can't have been a miscalculation here, the answer is that we did not learn this through a rule, but by learning to calculate.

45. We got to know the *nature* of calculating by learning to calculate.

46. But then can't it be described how we satisfy ourselves of the reliability of a calculation? O yes! Yet no rule emerges when we do so.--But the most important thing is: The rule is not needed. Nothing is lacking. We do calculate according to a rule, and that is enough.

47. *This* is how one calculates. Calculating is *this*. What we learn at school, for example. Forget this transcendent certainty, which is connected with your concept of spirit.

48. However, out of a host of calculations certain ones might be designated as reliable once for all, others as not yet fixed. And now, is this a *logical* distinction?

49. But remember: even when the calculation is something fixed for me, this is only a decision for a practical purpose.

50. When does one say, I know that... $\times \dots = \dots$? When one has checked the calculation.

51. What sort of proposition is: "What could a mistake here be like!?" It would have to be a logical proposition. But is it a logic that is not used, because what it tells us is not taught by means of propositions.--It is a logical proposition; for it does describe the conceptual (linguistic) situation.

52. This situation is thus not the same for a proposition like "At this distance from the sun there is a planet" and "Here is a hand" (namely my own hand). The second can't be called a hypothesis. But there isn't a sharp boundary line between them.

53. So one might grant that Moore was right, if he is interpreted like this: a proposition saying that here is a physical object may have the same logical status as one saying that here is a red patch.

54. For it is not true that a mistake merely gets more and more improbable as we pass from the planet to my own hand. No: at some point it has ceased to be conceivable.

This is already suggested by the following: if it were not so, it would also be conceivable that we should be wrong in *every* statement about physical objects; that any we ever make are mistaken.

55. So is the *hypothesis* possible, that all the things around us don't exist? Would that not be like the hypothesis of our having miscalculated in all our calculations?

56. When one says: "Perhaps this planet doesn't exist and the light-phenomenon arises in some other way", then after all one needs an example of an object which does exist. This doesn't exist,--as *for example* does....

Or are we to say that *certainty* is merely a constructed point to which some things approximate more, some less closely? No. Doubt gradually loses its sense. This language-game just *is* like that.

And everything descriptive of a language-game is part of logic.

57. Now might not "I *know*, I am not just surmising, that here is my hand" be conceived as a proposition of grammar? Hence *not* temporally.

But in that case isn't it like *this* one: "I know, I am not just surmising, that I am seeing red"?

And isn't the consequence "So there are physical objects" like: "So there are colours"?

58. If "I know etc'." is conceived as a grammatical proposition, of course the "I" cannot be important. And it properly means "There is no such thing as a doubt in this case" or "The expression 'I do not know' makes no sense in this case". And of course it follows from this that "I *know*" makes no sense either.

59. "I know" is here a *logical* insight. Only realism can't be proved by means of it.

60. It is wrong to say that the 'hypothesis' that *this* is a bit of paper would be confirmed or disconfirmed by later experience, and that, in "I know that this is a bit of paper," the "I know" either relates to such an hypothesis or to a logical determination.

61. ... A meaning of a word is a kind of employment of it.

For it is what we learn when the word is incorporated into our language.

62. That is why there exists a correspondence between the concepts 'rule' and 'meaning'.

63. If we imagine the facts otherwise than as they are, certain language-games lose some of their importance, while

others become important. And in this way there is an alteration--a gradual one--in the use of the vocabulary of a language.

Page 10

64. Compare the meaning of a word with the 'function' of an official. And 'different meanings' with 'different functions'.

Page 10

65. When language-games change, then there is a change in concepts, and with the concepts the meanings of words change.

Page 10

66. I make assertions about reality, assertions which have different degrees of assurance. How does the degree of assurance come out? What consequences has it?

We may be dealing, for example, with the certainty of memory, or again of perception. I may be sure of something, but still know what test might convince me of error. I am e.g. quite sure of the date of a battle, but if I should find a different date in a

Page Break 11

recognized work of history, I should alter my opinion, and this would not mean I lost all faith in judging.

Page 11

67. Could we imagine a man who keeps on making mistakes where we regard a mistake as ruled out, and in fact never encounter one?

E.g. he says he lives in such and such a place, is so and so old, comes from such and such a city, and he speaks with the same certainty (giving all the tokens of it) as I do, but he is wrong.

But what is his relation to this error? What am I to suppose?

Page 11

68. The question is: what is the logician to say here?

Page 11

69. I should like to say: "If I am wrong about *this*, I have no guarantee that anything I say is true." But others won't say that about me, nor will I say it about other people.

Page 11

70. For months I have lived at address A, I have read the name of the street and the number of the house countless times, have received countless letters here and given countless people the address. If I am wrong about it, the mistake is hardly less than if I were (wrongly) to believe I was writing Chinese and not German.

Page 11

71. If my friend were to imagine one day that he had been living for a long time past in such and such a place, etc. etc., I should not call this a *mistake*, but rather a mental disturbance, perhaps a transient one.

Page 11

72. Not every false belief of this sort is a mistake.

Page 11

73. But what is the difference between mistake and mental disturbance? Or what is the difference between my treating it as a mistake and my treating it as mental disturbance?

Page 11

74. Can we say: a *mistake* doesn't only have a cause, it also has a ground? I.e., roughly: when someone makes a mistake, this can be fitted into what he knows aright.

Page 11

75. Would this be correct: If I merely believed wrongly that there is a table here in front of me, this might still be a mistake; but if I believe wrongly that I have seen this table, or one like it, every day for several months past, and have regularly used it, that isn't a mistake?

Page Break 12

Page 12

76. Naturally, my aim must be to give the statements that one would like to make here, but cannot make significantly.

Page 12

77. Perhaps I shall do a multiplication twice to make sure, or perhaps get someone else to work it over. But shall I work it over again twenty times, or get twenty people to go over it? And is that some sort of negligence? Would the certainty really be greater for being checked twenty times?

Page 12

78. And can I give a *reason* why it isn't?

Page 12

79. That I am a man and not a woman can be verified, but if I were to say I was a woman, and then tried to explain the error by saying I hadn't checked the statement, the explanation would not be accepted.

Page 12

80. The *truth* of my statements is the test of my *understanding* of these statements.

Page 12

81. That is to say: if I make certain false statements, it becomes uncertain whether I understand them.

Page 12

82. What counts as an adequate test of a statement belongs to logic. It belongs to the description of the language-game.

Page 12

83. The *truth* of certain empirical propositions belongs to our frame of reference.

Page 12

84. Moore says he *knows* that the earth existed long before his birth. And put like that it seems to be a personal statement about him, even if it is in addition a statement about the physical world. Now it is philosophically uninteresting whether Moore knows this or that, but it is interesting that, and how, it can be known. If Moore had informed us that he knew the distance separating certain stars, we might conclude from that that he had made some special investigations, and we shall want to know what these were. But Moore chooses precisely a case in which we all seem to know the same as he, and without being able to say how. I believe e.g. that I know as much about this matter (the existence of the earth) as Moore does, and if he knows that it is as he says, then *I* know it too. For it isn't, either, as if he had arrived at his proposition

Page Break 13

by pursuing some line of thought which, while it is open to me, I have not in fact pursued.

Page 13

85. And what goes into someone's knowing this? Knowledge of history, say? He must know what it means to say: the earth has already existed for such and such a length of time. For not *any* intelligent adult must know that. We see men building and demolishing houses, and are led to ask: "How long has this house been here?" But how does one come on the idea of asking this about a mountain, for example? And have all men the notion of the earth as a *body*, which may come into being and pass away? Why shouldn't I think of the earth as flat, but extending without end in every direction (including depth)? But in that case one might still say "I know that this mountain existed long before my birth."-But suppose I met a man who didn't believe that?

Page 13

86. Suppose I replaced Moore's "I know" by "I am of the unshakeable conviction"?

Page 13

87. Can't an assertoric sentence, which was capable of functioning as an hypothesis, also be used as a foundation for research and action? I.e. can't it simply be isolated from doubt, though not according to any explicit rule? It simply gets assumed as a truism, never called in question, perhaps not even ever formulated.

Page 13

88. It maybe for example that *all enquiry on our part* is set so as to exempt certain propositions from doubt, if they are ever formulated. They lie apart from the route travelled by enquiry.

Page 13

89. One would like to say: "Everything speaks for, and nothing against the earth's having existed long before...."

Yet might I not believe the contrary after all? But the question is: What would the practical effects of this belief be?--Perhaps someone says: "That's not the point. A belief is what it is whether it has any practical effects or not." One thinks: It is the same adjustment of the human mind anyway.

Page 13

90. "I know" has a primitive meaning similar to and related to "I see" ("wissen", "videre"). And "I knew he was in the room, but he wasn't in the room" is like "I saw him in the room, but he wasn't there". "I know" is supposed to express a relation, not

Page Break 14

between me and the sense of a proposition (like "I believe") but between me and a fact. So that the *fact* is taken into my consciousness. (Here is the reason why one wants to say that nothing that goes on in the outer world is really known, but only what happens in the domain of what are called sense-data.) This would give us a picture of

knowing as the perception of an outer event through visual rays which project it as it is into the eye and the consciousness. Only then the question at once arises whether one can be *certain* of this projection. And this picture does indeed show how our *imagination* presents knowledge, but not what lies at the bottom of this presentation.

Page 14

91. If Moore says he knows the earth existed etc., most of us will grant him that it has existed all that time, and also believe him when he says he is convinced of it. But has he also got the right *ground* for his conviction? For if not, then after all he doesn't *know* (Russell).

Page 14

92. However, we can ask: May someone have telling grounds for believing that the earth has only existed for a short time, say since his own birth?--Suppose he had always been told that,--would he have any good reason to doubt it? Men have believed that they could make rain; why should not a king be brought up in the belief that the world began with him? And if Moore and this king were to meet and discuss, could Moore really prove his belief to be the right one? I do not say that Moore could not convert the king to his view, but it would be a conversion of a special kind; the king would be brought to look at the world in a different way.

Remember that one is sometimes convinced of the *correctness* of a view by its *simplicity* or *symmetry*, i.e., these are what induce one to go over to this point of view. One then simply says something like: "*That's* how it must be."

Page 14

93. The propositions presenting what Moore '*knows*' are all of such a kind that it is difficult to imagine *why* anyone should believe the contrary. E.g. the proposition that Moore has spent his whole life in close proximity to the earth.--Once more I can speak of myself here instead of speaking of Moore. What could induce me to believe the opposite? Either a memory, or having been told.--

Page Break 15

Everything that I have seen or heard gives me the conviction that no man has ever been far from the earth. Nothing in my picture of the world speaks in favour of the opposite.

Page 15

94. But I did not get my picture of the world by satisfying myself of its correctness; nor do I have it because I am satisfied of its correctness. No: it is the inherited background against which I distinguish between true and false.

Page 15

95. The propositions describing this world-picture might be part of a kind of mythology. And their role is like that of rules of a game; and the game can be learned purely practically, without learning any explicit rules.

Page 15

96. It might be imagined that some propositions, of the form of empirical propositions, were hardened and functioned as channels for such empirical propositions as were not hardened but fluid; and that this relation altered with time, in that fluid propositions hardened, and hard ones became fluid.

Page 15

97. The mythology may change back into a state of flux, the river-bed of thoughts may shift. But I distinguish between the movement of the waters on the river-bed and the shift of the bed itself; though there is not a sharp division of the one from the other.

Page 15

98. But if someone were to say "So logic too is an empirical science" he would be wrong. Yet this is right: the same proposition may get treated at one time as something to test by experience, at another as a rule of testing.

Page 15

99. And the bank of that river consists partly of hard rock, subject to no alteration or only to an imperceptible one, partly of sand, which now in one place now in another gets washed away, or deposited.

Page 15

100. The truths which Moore says he knows, are such as, roughly speaking, all of us know, if he knows them.

Page 15

101. Such a proposition might be e.g. "My body has never disappeared and reappeared again after an interval."

Page 15

102. Might I not believe that once, without knowing it, perhaps in a state of unconsciousness, I was taken far away from the earth

Page Break 16

--that other people even know this, but do not mention it to me? But this would not fit into the rest of my convictions at all. Not that I could describe the system of these convictions. Yet my convictions do form a system, a

structure.

Page 16

103. And now if I were to say "It is my unshakeable conviction that etc.", this means in the present case too that I have not consciously arrived at the conviction by following a particular line of thought, but that it is anchored in all my *questions and answers*, so anchored that I cannot touch it.

Page 16

104. I am for example also convinced that the sun is not a hole in the vault of heaven.

Page 16

105. All testing, all confirmation and disconfirmation of a hypothesis takes place already within a system. And this system is not a more or less arbitrary and doubtful point of departure for all our arguments: no, it belongs to the essence of what we call an argument. The system is not so much the point of departure, as the element in which arguments have their life.

Page 16

106. Suppose some adult had told a child that he had been on the moon. The child tells me the story, and I say it was only a joke, the man hadn't been on the moon; no one has ever been on the moon; the moon is a long way off and it is impossible to climb up there or fly there.--If now the child insists, saying perhaps there is a way of getting there which I don't know, etc. what reply could I make to him? What reply could I make to the adults of a tribe who believe that people sometimes go to the moon (perhaps that is how they interpret their dreams), and who indeed grant that there are no ordinary means of climbing up to it or flying there?--But a child will not ordinarily stick to such a belief and will soon be convinced by what we tell him seriously.

Page 16

107. Isn't this altogether like the way one can instruct a child to believe in a God, or that none exists, and it will accordingly be able to produce apparently telling grounds for the one or the other?

Page Break 17

Page 17

108. "But is there then no objective truth? Isn't it true, or false, that someone has been on the moon?" If we are thinking within our system, then it is certain that no one has ever been on the moon. Not merely is nothing of the sort ever seriously reported to us by reasonable people, but our whole system of physics forbids us to believe it. For this demands answers to the questions "How did he overcome the force of gravity?" "How could he live without an atmosphere?" and a thousand others which could not be answered. But suppose that instead of all these answers we met the reply: "We don't know *how* one gets to the moon, but those who get there know at once that they are there; and even you can't explain everything." We should feel ourselves intellectually very distant from someone who said this.

Page 17

109. "An empirical proposition can be *tested*" (we say). But how? and through what?

Page 17

110. What *counts* as its test? "But is this an adequate test? And, if so, must it not be recognizable as such in logic?"--As if giving grounds did not come to an end sometime. But the end is not an ungrounded presupposition: it is an ungrounded way of acting.

Page 17

111. "I *know* that I have never been on the moon." That sounds quite different in the circumstances which actually hold, to the way it would sound if a good many men had been on the moon, and some perhaps without knowing it. In *this* case one could give grounds for this knowledge. Is there not a relationship here similar to that between the general rule of multiplying and particular multiplications that have been carried out?

I want to say: my not having been on the moon is as sure a thing for me as any grounds I could give for it.

Page 17

112. And isn't that what Moore wants to say, when he says he *knows* all these things?--But is his knowing it really what is in question, and not rather that some of these propositions must be solid for us?

Page 17

113. When someone is trying to teach us mathematics, he will not begin by assuring us that he *knows* that $a + b = b + a$.

Page 17

114. If you are not certain of any fact, you cannot be certain of the meaning of your words either.

Page Break 18

Page 18

115. If you tried to doubt everything you would not get as far as doubting anything. The game of doubting itself presupposes certainty.

Page 18

116. Instead of "I know...", couldn't Moore have said: "It stands fast for me that..."? And further: "It stands fast for me and many others...."

Page 18

117. Why is it not possible for me to doubt that I have never been on the moon? And how could I try to doubt it?

First and foremost, the supposition that perhaps I have been there would strike me as *idle*. Nothing would follow from it, nothing be explained by it. It would not tie in with anything in my life.

When I say "Nothing speaks for, everything against it," this presupposes a principle of speaking for and against. That is, I must be able to say what *would* speak for it.

Page 18

118. Now would it be correct to say: So far no one has opened my skull in order to see whether there is a brain inside; but everything speaks for, and nothing against, its being what they would find there?

Page 18

119. But can it also be said: Everything speaks for, and nothing against the table's still being there when no one sees it? For what does speak for it?

Page 18

120. But if anyone were to doubt it, how would his doubt come out in practice? And couldn't we peacefully leave him to doubt it, since it makes no difference at all?

Page 18

121. Can one say: "Where there is no doubt there is no knowledge either"?

Page 18

122. Doesn't one need grounds for doubt?

Page 18

123. Wherever I look, I find no ground for doubting that....

Page 18

124. I want to say: We use judgments as principles of judgment.

Page 18

125. If a blind man were to ask me "Have you got two hands?" I should not make sure by looking. If I were to have any doubt of it, then I don't know why I should trust my eyes. For why shouldn't I test my *eyes* by looking to find out whether I see my

Page Break 19

two hands? *What* is to be tested by *what*? (Who decides *what* stands fast?)

And what does it mean to say that such and such stands fast?

Page 19

126. I am not more certain of the meaning of my words than I am of certain judgments. Can I doubt that this colour is called "blue"?

(My) doubts form a system.

Page 19

127. For how do I know that someone is in doubt? How do I know that he uses the words "I doubt it" as I do?

Page 19

128. From a child up I learnt to judge like this. *This is* judging.

Page 19

129. This is how I learned to judge; *this* I got to know *as* judgment.

Page 19

130. But isn't it experience that teaches us to judge like *this*, that is to say, that it is correct to judge like *this*? But how does experience *teach* us, then? *We* may derive it from experience, but experience does not direct us to derive anything from experience. If it is the *ground* of our judging like *this*, and not just the cause, still we do not have a ground for seeing *this* in turn as a ground.

Page 19

131. No, experience is not the ground for our game of judging. Nor is its outstanding success.

Page 19

132. Men have judged that a king can make rain; *we* say this contradicts all experience. Today they judge that aeroplanes and the radio etc. are means for the closer contact of peoples and the spread of culture.

Page 19

133. Under ordinary circumstances I do not satisfy myself that I have two hands by seeing how it looks. *Why not?* Has experience shown it to be unnecessary? Or (again): Have we in some way learnt a universal law of induction, and do we trust it here too?--But why should we have learnt one *universal* law first, and not the special one straight away?

Page 19

134. After putting a book in a drawer, I assume it is there, unless.... "Experience always proves me right. There is no well attested case of a book's (simply) disappearing." It has *often* happened that a book has never turned up again, although we

Page Break 20

thought we knew for certain where it was.--But experience does really teach that a book, say, does not vanish away. (E.g. gradually evaporate.) But is it this experience with books etc. that leads us to assume that such a book has not vanished away? Well, suppose we were to find that under particular novel circumstances books did vanish away.--Shouldn't we alter our assumption? Can one give the lie to the effect of experience on our system of assumption?

Page 20

135. But do we not simply follow the principle that what has always happened will happen again (or something like it)? What does it mean to follow this principle? Do we really introduce it into our reasoning? Or is it merely the *natural law* which our inferring apparently follows? This latter it may be. It is not an item in our considerations.

Page 20

136. When Moore says he *knows* such and such, he is really enumerating a lot of empirical propositions which we affirm without special testing; propositions, that is, which have a peculiar logical role in the system of our empirical propositions.

Page 20

137. Even if the most trustworthy of men assures me that he *knows* things are thus and so, this by itself cannot satisfy me that he does know. Only that he believes he knows. That is why Moore's assurance that he knows... does not interest us. The propositions, however, which Moore retails as examples of such known truths are indeed interesting. Not because anyone knows their truth, or believes he knows them, but because they all have a *similar* role in the system of our empirical judgments.

Page 20

138. We don't, for example, arrive at any of them as a result of investigation.

There are e.g. historical investigations and investigations into the shape and also the age of the earth, but not into whether the earth has existed during the last hundred years. Of course many of us have information about this period from our parents and grandparents; but mayn't they be wrong?--"Nonsense!" one will say. "How should all these people be wrong?"--But is that an argument? Is it not simply the rejection of an idea? And

Page Break 21

perhaps the determination of a concept? For if I speak of a possible mistake here, this changes the role of "mistake" and "truth" in our lives.

Page 21

139. Not only rules, but also examples are needed for establishing a practice. Our rules leave loop-holes open, and the practice has to speak for itself.

Page 21

140. We do not learn the practice of making empirical judgments by learning rules: we are taught *judgments* and their connexion with other judgments. A *totality* of judgments is made plausible to us.

Page 21

141. When we first begin to *believe* anything, what we believe is not a single proposition, it is a whole system of propositions. (Light dawns gradually over the whole.)

Page 21

142. It is not single axioms that strike me as obvious, it is a system in which consequences and premises give one another *mutual* support.

Page 21

143. I am told, for example, that someone climbed this mountain many years ago. Do I always enquire into the reliability of the teller of this story, and whether the mountain did exist years ago? A child learns there are reliable and unreliable informants much later than it learns facts which are told it. It doesn't learn *at all* that that mountain has existed for a long time: that is, the question whether it is so doesn't arise at all. It swallows this consequence down, so to speak, together with *what* it learns.

Page 21

144. The child learns to believe a host of things. I.e. it learns to act according to these beliefs. Bit by bit there forms a system of what is believed, and in that system some things stand unshakeably fast and some are more or less liable to shift. What stands fast does so, not because it is intrinsically obvious or convincing; it is rather held fast by what lies around it.

Page 21

145. One wants to say "*All my experiences shew that it is so*". But how do they do that? For that proposition to which they point itself belongs to a particular interpretation of them.

"That I regard this proposition as certainly true also characterizes my interpretation of experience."

Page Break 22

Page 22

146. We form *the picture* of the earth as a ball floating free in space and not altering essentially in a hundred years. I said "*We form the picture etc.*" and this picture now helps us in the judgment of various situations.

I may indeed calculate the dimensions of a bridge, sometimes calculate that here things are more in favour of a bridge than a ferry, etc. etc.,--but somewhere I must begin with an assumption or a decision.

Page 22

147. The picture of the earth as a ball is a *good* picture, it proves itself everywhere, it is also a simple picture--in short, we work with it without doubting it.

Page 22

148. Why do I not satisfy myself that I have two feet when I want to get up from a chair? There is no why. I simply don't. This is how I act.

Page 22

149. My judgments themselves characterize the way I judge, characterize the nature of judgment.

Page 22

150. How does someone judge which is his right and which his left hand? How do I know that my judgment will agree with someone else's? How do I know that this colour is blue? If I don't trust *myself* here, why should I trust anyone else's judgment? Is there a why? Must I not begin to trust somewhere? That is to say: somewhere I must begin with not-doubting; and that is not, so to speak, hasty but excusable: it is part of judging.

Page 22

151. I should like to say: Moore does not *know* what he asserts he knows, but it stands fast for him, as also for me; regarding it as absolutely solid is part of our *method* of doubt and enquiry.

Page 22

152. I do not explicitly learn the propositions that stand fast for me. I can *discover* them subsequently like the axis around which a body rotates. This axis is not fixed in the sense that anything holds it fast, but the movement around it determines its immobility.

Page 22

153. No one ever taught me that my hands don't disappear when I am not paying attention to them. Nor can I be said to presuppose the truth of this proposition in my assertions etc., (as if they rested on it) while it only gets sense from the rest of our procedure of asserting.

Page Break 23

Page 23

154. There are cases such that, if someone gives signs of doubt where we do not doubt, we cannot confidently understand his signs as signs of doubt.

I.e.: if we are to understand his signs of doubt as such, he may give them only in particular cases and may not give them in others.

Page 23

155. In certain circumstances a man cannot make a *mistake*. ("Can" is here used logically, and the proposition does not mean that a man cannot say anything false in those circumstances.) If Moore were to pronounce the opposite of those propositions which he declares certain, we should not just not share his opinion: we should regard him as demented.

Page 23

156. In order to make a mistake, a man must already judge in conformity with mankind.

Page 23

157. Suppose a man could not remember whether he had always had five fingers or two hands? Should we understand him? Could we be sure of understanding him?

158. Can I be making a mistake, for example, in thinking that the words of which this sentence is composed are English words whose meaning I know?

159. As children we learn facts; e.g., that every human being has a brain, and we take them on trust. I believe that there is an island, Australia, of such-and-such a shape, and so on and so on; I believe that I had great-grandparents, that the people who gave themselves out as my parents really were my parents, etc. This belief may never have been expressed; even the thought that it was so, never thought.

160. The child learns by believing the adult. Doubt comes *after* belief.

161. I learned an enormous amount and accepted it on human authority, and then I found some things confirmed or disconfirmed by my own experience.

162. In general I take as true what is found in text-books, of geography for example. Why? I say: All these facts have been confirmed a hundred times over. But how do I know that? What is my evidence for it? I have a world-picture. Is it true or false? Above all it is the substratum of all my enquiring and asserting.

The propositions describing it are not all equally subject to testing.

163. Does anyone ever test whether this table remains in existence when no one is paying attention to it?

We check the story of Napoleon, but not whether all the reports about him are based on sense-deception, forgery and the like. For whenever we test anything, we are already presupposing something that is not tested. Now am I to say that the experiment which perhaps I make in order to test the truth of a proposition presupposes the truth of the proposition that the apparatus I believe I see is really there (and the like)?

164. Doesn't testing come to an end?

165. One child might say to another: "I know that the earth is already hundreds of years old" and that would mean: I have learnt it.

166. The difficulty is to realize the groundlessness of our believing.

167. It is clear that our empirical propositions do not all have the same status, since one can lay down such a proposition and turn it from an empirical proposition into a norm of description.

Think of chemical investigations. Lavoisier makes experiments with substances in his laboratory and now he concludes that this and that takes place when there is burning. He does not say that it might happen otherwise another time. He has got hold of a definite world-picture--not of course one that he invented: he learned it as a child. I say world-picture and not hypothesis, because it is the matter-of-course foundation for his research and as such also goes unmentioned.

168. But now, what part is played by the presupposition that a substance A always reacts to a substance B in the same way, given the same circumstances? Or is that part of the definition of a substance?

169. One might think that there were propositions declaring that chemistry is *possible*. And these would be propositions of a natural science. For what should they be supported by, if not by experience?

170. I believe what people transmit to me in a certain manner. In this way I believe geographical, chemical, historical facts etc.

That is how I *learn* the sciences. Of course learning is based on believing.

If you have learnt that Mont Blanc is 4000 metres high, if you have looked it up on the map, you say you *know* it.

And can it now be said: we accord credence in this way because it has proved to pay?

171. A principal ground for Moore to assume that he never was on the moon is that no one ever was on the moon or *could* come there; and this we believe on grounds of what we learn.

Page 25

172. Perhaps someone says "There must be some basic principle on which we accord credence", but what can such a principle accomplish? Is it more than a natural law of 'taking for true'?

Page 25

173. Is it maybe in my power what I believe? or what I unshakeably believe?

I believe that there is a chair over there. Can't I be wrong? But, can I believe that I am wrong? Or can I so much as bring it under consideration?--And mightn't I also hold fast to my belief whatever I learned later on?! But is my belief then *grounded*?

Page 25

174. I act with *complete* certainty. But this certainty is my own.

Page 25

175. "I know it" I say to someone else; and here there is a justification. But there is none for my belief.

Page 25

176. Instead of "I know it" one may say in some cases "That's how it is--rely upon it." In some cases, however "I learned it years and years ago"; and sometimes: "I am sure it is so."

Page 25

177. What I know, I believe.

Page 25

178. The wrong use made by Moore of the proposition "I know..." lies in his regarding it as an utterance as little subject to doubt as "I am in pain". And since from "I know it is so" there follows "It is so", then the latter can't be doubted either.

Page 25

179. It would be correct to say: "I believe..." has subjective truth; but "I know..." not.

Page Break 26

Page 26

180. Or again "I believe..." is an 'expression', but not "I know...".

Page 26

181. Suppose Moore had said "I swear..." instead of "I know...".

Page 26

182. The more primitive idea is that the earth *never* had a beginning. No child has reason to ask himself how long the earth has existed, because all change takes place *on* it. If what is called the earth really came into existence at some time--which is hard enough to picture--then one naturally assumes the beginning as having been an inconceivably long time ago.

Page 26

183. "It is certain that after the battle of Austerlitz Napoleon.... Well, in that case it's surely also certain that the earth existed then."

Page 26

184. "It is certain that we didn't arrive on this planet from another one a hundred years ago." Well, it's as certain as such things *are*.

Page 26

185. It would strike me as ridiculous to want to doubt the existence of Napoleon; but if someone doubted the existence of the earth 150 years ago, perhaps I should be more willing to listen, for now he is doubting our whole system of evidence. It does not strike me as if this system were more certain than a certainty within it.

Page 26

186. "I might suppose that Napoleon never existed and is a fable, but not that the *earth* did not exist 150 years ago."

Page 26

187. "Do you *know* that the earth existed then?"--"Of course I know that. I have it from someone who certainly knows all about it."

Page 26

188. It strikes me as if someone who doubts the existence of the earth at that time is impugning the nature of all historical evidence. And I cannot say of this latter that it is definitely *correct*.

Page 26

189. At some point one has to pass from explanation to mere description.

Page 26

190. What we call historical evidence points to the existence of the earth a long time before my birth;--the opposite hypothesis has *nothing* on its side.

Page Break 27

Page 27

191. Well, if everything speaks for an hypothesis and nothing against it--is it then certainly true? One may designate it as such.--But does it certainly agree with reality, with the facts?--With this question you are already going round in a circle.

Page 27

192. To be sure there is justification; but justification comes to an end.

Page 27

193. What does this mean: the truth of a proposition is *certain*?

Page 27

194. With the word "certain" we express complete conviction, the total absence of doubt, and thereby we seek to convince other people. That is *subjective* certainty.

But when is something objectively certain? When a mistake is not possible. But what kind of possibility is that? Mustn't mistake be *logically* excluded?

Page 27

195. If I believe that I am sitting in my room when I am not, then I shall not be said to have *made a mistake*. But what is the essential difference between this case and a mistake?

Page 27

196. Sure evidence is what we *accept* as sure, it is evidence that we go by in *acting* surely, acting without any doubt. What we call "a mistake" plays a quite special part in our language games, and so too does what we regard as certain evidence.

Page 27

197. It would be nonsense to say that we regard something as sure evidence because it is certainly true.

Page 27

198. Rather, we must first determine the role of deciding for or against a proposition.

Page 27

199. The reason why the use of the expression "true or false" has something misleading about it is that it is like saying "it tallies with the facts or it doesn't", and the very thing that is in question is what "tallying" is here.

Page 27

200. Really "The proposition is either true or false" only means that it must be possible to decide for or against it. But this does not say what the ground for such a decision is like.

Page 27

201. Suppose someone were to ask: "Is it really right for us to rely on the evidence of our memory (or our senses) as we do?"

Page Break 28

Page 28

202. Moore's certain propositions almost declare that we have a right to rely upon this evidence.

Page 28

203. [Everything[†]1 that we regard as evidence indicates that the earth already existed long before my birth. The contrary hypothesis has *nothing* to confirm it at all.

If everything speaks *for* an hypothesis and nothing against it, is it objectively *certain*? One can *call* it that. But does it *necessarily* agree with the world of facts? At the very best it shows us what "agreement" means. We find it difficult to imagine it to be false, but also difficult to make use of it.]

What does this agreement consist in, if not in the fact that what is evidence in these language games speaks for our proposition? (*Tractatus Logico-Philosophicus*)

Page 28

204. Giving grounds, however, justifying the evidence, comes to an end;--but the end is not certain propositions' striking us immediately as true, i.e. it is not a kind of *seeing* on our part; it is our *acting*, which lies at the bottom of the language-game.

Page 28

205. If the true is what is grounded, then the ground is not *true*, nor yet false.

Page 28

206. If someone asked us "but is that *true*?" we might say "yes" to him; and if he demanded grounds we might say "I can't give you any grounds, but if you learn more you too will think the same".

If this didn't come about, that would mean that he couldn't for example learn history.

Page 28

207. "Strange coincidence, that every man whose skull has been opened had a brain"

Page 28

208. I have a telephone conversation with New York. My friend tells me that his young trees have buds of such and such a kind. I am now convinced that his tree is.... Am I also convinced that the earth exists?

Page 28

209. The existence of the earth is rather part of the whole *picture* which forms the starting-point of belief for me.

Page 28

210. Does my telephone call to New York strengthen my conviction that the earth exists?

Page Break 29

Page 29

Much seems to be fixed, and it is removed from the traffic. It is so to speak shunted onto an unused siding.

Page 29

211. Now it gives our way of looking at things, and our researches, their form. Perhaps it was once disputed. But perhaps, for unthinkable ages, it has belonged to the *scaffolding* of our thoughts. (Every human being has parents.)

Page 29

212. In certain circumstances, for example, we regard a calculation as sufficiently checked. What gives us a right to do so? Experience? May that not have deceived us? Somewhere we must be finished with justification, and then there remains the proposition that *this* is how we calculate.

Page 29

213. Our 'empirical propositions' do not form a homogeneous mass.

Page 29

214. What prevents me from supposing that this table either vanishes or alters its shape and colour when no one is observing it, and then when someone looks at it again changes back to its old condition? "But who is going to suppose such a thing!"--one would feel like saying.

Page 29

215. Here we see that the idea of 'agreement with reality' does not have any clear application.

Page 29

216. The proposition "It is written".

Page 29

217. If someone supposed that *all* our calculations were uncertain and that we could rely on none of them (justifying himself by saying that mistakes are always possible) perhaps we would say he was crazy. But can we say he is in error? Does he not just react differently? We rely on calculations, he doesn't; we are sure, he isn't.

Page 29

218. Can I believe for one moment that I have ever been in the stratosphere? No. So do I *know* the contrary, like Moore?

Page 29

219. There cannot be any doubt about it for me as a reasonable person.--That's it.--

Page 29

220. The reasonable man *does not* have certain doubts.

Page 29

221. Can I be in doubt at *will*?

Page 29

222. I cannot possibly doubt that I was never in the stratosphere. Does that make me know it? Does it make it true?

Page Break 30

Page 30

223. For mightn't I be crazy and not doubting what I absolutely ought to doubt?

Page 30

224. "I *know* that it never happened, for if it had happened I could not possibly have forgotten it."

Page 30

But, supposing it *did* happen, then it just would have been the case that you had forgotten it. And how do

you know that you could not possibly have forgotten it? Isn't that just from earlier experience?

Page 30

225. What I hold fast to is not *one* proposition but a nest of propositions.

Page 30

226. Can I give the supposition that I have ever been on the moon any serious consideration at all?

Page 30

227. "Is that something that one can forget?!"

Page 30

228. "In such circumstances, people do not say 'Perhaps we've all forgotten', and the like, but rather they assume that..."

Page 30

229. Our talk gets its meaning from the rest of our proceedings.

Page 30

230. We are asking ourselves: what do we do with a statement "*I know...*"? For it is not a question of mental processes or mental states.

Page 30

And *that* is how one must decide whether something is knowledge or not.

Page 30

231. If someone doubted whether the earth had existed a hundred years ago, I should not understand, for *this* reason: I would not know what such a person would still allow to be counted as evidence and what not.

Page 30

232. "We could doubt every single one of these facts, but we could not doubt them *all*."

Wouldn't it be more correct to say: "we do not doubt them *all*".

Our not doubting them all is simply our manner of judging, and therefore of acting.

Page 30

233. If a child asked me whether the earth was already there before my birth, I should answer him that the earth did not begin only with my birth, but that it existed long, long before. And I should have the feeling of saying something funny.

Page Break 31

Rather as if the child had asked if such and such a mountain were higher than a tall house that it had seen. In answering the question I should have to be imparting a picture of the world to the person who asked it.

If I do answer the question with certainty, what gives me this certainty?

Page 31

234. I believe that I have forebears, and that every human being has them. I believe that there are various cities, and, quite generally, in the main facts of geography and history. I believe that the earth is a body on whose surface we move and that it no more suddenly disappears or the like than any other solid body: this table, this house, this tree, etc. If I wanted to doubt the existence of the earth long before my birth, I should have to doubt all sorts of things that stand fast for me.

Page 31

235. And that something stands fast for me is not grounded in my stupidity or credulity.

Page 31

236. If someone said "The earth has not long been..." what would he be impugning? Do I know?

Would it have to be what is called a scientific belief? Might it not be a mystical one? Is there any absolute necessity for him to be contradicting historical facts? or even geographical ones?

Page 31

237. If I say "an hour ago this table didn't exist", I probably mean that it was only made later on.

If I say "this mountain didn't exist then", I presumably mean that it was only formed later on--perhaps by a volcano.

If I say "this mountain didn't exist half an hour ago", that is such a strange statement that it is not clear what I mean. Whether for example I mean something untrue but scientific. Perhaps you think that the statement that the mountain didn't exist then is quite clear, however one conceives the context. But suppose someone said "This mountain didn't exist a minute ago, but an exactly similar one did instead". Only the accustomed context allows what is meant to come through clearly.

Page 31

238. I might therefore interrogate someone who said that the earth did not exist before his birth, in order to find out which of

Page Break 32

my convictions he was at odds with. And then it *might* be that he was contradicting my fundamental attitudes, and if that were how it was, I should have to put up with it.

Similarly if he said he had at some time been on the moon.

Page 32

239. I believe that every human being has two human parents; but Catholics believe that Jesus only had a human mother. And other people might believe that there are human beings with no parents, and give no credence to all the contrary evidence. Catholics believe as well that in certain circumstances a wafer completely changes its nature, and at the same time that all evidence proves the contrary. And so if Moore said "I know that this is wine and not blood", Catholics would contradict him.

Page 32

240. What is the belief that all human beings have parents based on? On experience. And how can I base this sure belief on my experience? Well, I base it not only on the fact that I have known the parents of certain people but on everything that I have learnt about the sexual life of human beings and their anatomy and physiology: also on what I have heard and seen of animals. But then is that really a proof?

Page 32

241. Isn't this an hypothesis, which, as I *believe*, is again and again completely confirmed?

Page 32

242. Mustn't we say at every turn: "I *believe* this with certainty"?

Page 32

243. One says "I know" when one is ready to give compelling grounds. "I know" relates to a possibility of demonstrating the truth. Whether someone knows something can come to light, assuming that he is convinced of it.

But if what he believes is of such a kind that the grounds that he can give are no surer than his assertion, then he cannot say that he knows what he believes.

Page 32

244. If someone says "I have a body", he can be asked "Who is speaking here with this mouth?"

Page 32

245. To whom does anyone say that he knows something? To himself, or to someone else. If he says it to himself, how is it distinguished from the assertion that he is *sure* that things are like that? There is no subjective sureness that I know something. The

Page Break 33

certainty is subjective, but not the knowledge. So if I say "I know that I have two hands", and that is not supposed to express just my subjective certainty, I must be able to satisfy myself that I am right. But I can't do that, for my having two hands is not less certain before I have looked at them than afterwards. But I could say: "That I have two hands is an irreversible belief." That would express the fact that I am not ready to let anything count as a disproof of this proposition.

Page 33

246. "Here I have arrived at a foundation of all my beliefs." "This position I will *hold!*" But isn't that, precisely, only because I am completely *convinced* of it?--What is 'being completely convinced' like?

Page 33

247. What would it be like to doubt now whether I have two hands? Why can't I imagine it at all? What would I believe if I didn't believe that? So far I have no system at all within which this doubt might exist.

Page 33

248. I have arrived at the rock bottom of my convictions.

And one might almost say that these foundation-walls are carried by the whole house.

Page 33

249. One gives oneself a false picture of *doubt*.

Page 33

250. My having two hands is, in normal circumstances, ascertain as anything that I could produce in evidence for it. That is why I am not in a position to take the sight of my hand as evidence for it.

Page 33

251. Doesn't this mean: I shall proceed according to this belief unconditionally, and not let anything confuse me?

Page 33

252. But it isn't just that I *believe* in this way that I have two hands, but that every reasonable person does.

Page 33

253. At the foundation of well-founded belief lies belief that is not founded.

Page 33

254. Any 'reasonable' person behaves like *this*.

Page 33

255. Doubting has certain characteristic manifestations, but they are only characteristic of it in particular circumstances. If

Page Break 34

someone said that he doubted the existence of his hands, kept looking at them from all sides, tried to make sure it wasn't 'all done by mirrors', etc., we should not be sure whether we ought to call that doubting. We might describe his way of behaving as like the behaviour of doubt, but his game would not be ours.

Page 34

256. On the other hand a language-game does change with time.

Page 34

257. If someone said to me that he doubted whether he had a body I should take him to be a half-wit. But I shouldn't know what it would mean to try to convince him that he had one. And if I had said something, and that had removed his doubt, I should not know how or why.

Page 34

258. I do not know how the sentence "I have a body" is to be used.

That doesn't unconditionally apply to the proposition that I have always been on or near the surface of the earth.

Page 34

259. Someone who doubted whether the earth had existed for 100 years might have a scientific, or on the other hand a philosophical, doubt.

Page 34

260. I would like to reserve the expression "I know" for the cases in which it is used in normal linguistic exchange.

Page 34

261. I cannot at present imagine a reasonable doubt as to the existence of the earth during the last 100 years.

Page 34

262. I can imagine a man who had grown up in quite special circumstances and been taught that the earth came into being 50 years ago, and therefore believed this. We might instruct him: the earth has long... etc.--We should be trying to give him our picture of the world.

This would happen through a kind of *persuasion*.

Page 34

263. The schoolboy *believes* his teachers and his schoolbooks.

Page 34

264. I could imagine Moore being captured by a wild tribe, and their expressing the suspicion that he has come from somewhere between the earth and the moon. Moore tells them that he

Page Break 35

knows etc. but he can't give them the grounds for his certainty, because they have fantastic ideas of human ability to fly and know nothing about physics. This would be an occasion for making that statement.

Page 35

265. But what does it say, beyond "I have never been to such and such a place, and have compelling grounds for believing that"?

Page 35

266. And here one would still have to say what are compelling grounds.

Page 35

267. "I don't merely have the visual impression of a tree: I *know* that it is a tree".

Page 35

268. "I know that this is a hand."--And what is a hand?--"Well, *this*, for example."

Page 35

269. Am I more certain that I have never been on the moon than that I have never been in Bulgaria? Why am I so sure? Well, I know that I have never been anywhere in the neighbourhood--for example I have never been in the Balkans.

Page 35

270. "I have compelling grounds for my certitude." These grounds make the certitude objective.

Page 35

271. What is a telling ground for something is not anything *I* decide.

Page 35

272. I know = I am familiar with it as a certainty.

Page 35

273. But when does one say of something that it is certain?

For there can be dispute whether something *is* certain; I mean, when something is *objectively* certain.

There are countless general empirical propositions that count as certain for us.

Page 35

274. One such is that if someone's arm is cut off it will not grow again. Another, if someone's head is cut off he is dead and will never live again.

Experience can be said to teach us these propositions. However, it does not teach us them in isolation: rather, it teaches us a host of interdependent propositions. If they were isolated I might perhaps doubt them, for I have no experience relating to them.

Page 35

275. If experience is the ground of our certainty, then naturally it is past experience.

Page Break 36

Page 36

And it isn't for example just my experience, but other people's, that I get knowledge from.

Now one might say that it is experience again that leads us to give credence to others. But what experience makes me believe that the anatomy and physiology books don't contain what is false? Though it is true that this trust is *backed up* by my own experience.

Page 36

276. We believe, so to speak, that this great building exists, and then we see, now here, now there, one or another small corner of it.

Page 36

277. "I can't help believing...."

Page 36

278. "I am comfortable that that is how things are."

Page 36

279. It is quite sure that motor cars don't grow out of the earth. We feel that if someone could believe the contrary he could believe *everything* that we say is untrue, and could question everything that we hold to be sure.

But how does this *one* belief hang together with all the rest? We should like to say that someone who could believe that does not accept our whole system of verification.

This system is something that a human being acquires by means of observation and instruction. I intentionally do not say "learns".

Page 36

280. After he has seen this and this and heard that and that, he is not in a position to doubt whether....

Page 36

281. *I, L. W.*, believe, am sure, that my friend hasn't sawdust in his body or in his head, even though I have no direct evidence of my senses to the contrary. I am sure, by reason of what has been said to me, of what I have read, and of my experience. To have doubts about it would seem to me madness--of course, this is also in agreement with other people; but *I* agree with them.

Page 36

282. I cannot say that I have good grounds for the opinion that cats do not grow on trees or that I had a father and a mother.

If someone has doubts about it--how is that supposed to have come about? By his never, from the beginning, having believed that he had parents? But then, is that conceivable, unless he has been taught it?

Page Break 37

Page 37

283. For how can a child immediately doubt what it is taught? That could mean only that he was incapable of learning certain language games.

Page 37

284. People have killed animals since the earliest times, used the fur, bones etc. etc. for various purposes; they have counted definitely on finding similar parts in any similar beast.

They have always learnt from experience; and we can see from their actions that they believe certain things definitely, whether they express this belief or not. By this I naturally do not want to say that men *should* behave like this, but only that they do behave like this.

Page 37

285. If someone is looking for something and perhaps roots around in a certain place, he shows that he believes that what he is looking for is there.

Page 37

286. What we believe depends on what we learn. We all believe that it isn't possible to get to the moon; but there might be people who believe that that is possible and that it sometimes happens. We say: these people do not know a lot that we know. And, let them be never so sure of their belief--they are wrong and we know it.

If we compare our system of knowledge with theirs then theirs is evidently the poorer one by far.

23.9.50

Page 37

287. The squirrel does not infer by induction that it is going to need stores next winter as well. And no more do we need a law of induction to justify our actions or our predictions.

Page 37

288. I know, not just that the earth existed long before my birth, but also that it is a large body, that this has been established, that I and the rest of mankind have forebears, that there are books about all this, that such books don't lie, etc. etc. etc. And I know all this? I believe it. This body of knowledge has been handed on to me and I have no grounds for doubting it, but, on the contrary, all sorts of confirmation.

And why shouldn't I say that I know all this? Isn't that what one does say?

Page Break 38

Page 38

But not only I know, or believe, all that, but the others do too. Or rather, I *believe* that they believe it.

Page 38

289. I am firmly convinced that others believe, believe they know, that all that is in fact so.

Page 38

290. I myself wrote in my book that children learn to understand a word in such and such a way. Do I know that, or do I believe it? Why in such a case do I write not "I believe etc." but simply the indicative sentence?

Page 38

291. We know that the earth is round. We have definitively ascertained that it is round.

We shall stick to this opinion, unless our whole way of seeing nature changes. "How do you know that?"--I believe it.

Page 38

292. Further experiments cannot *give the lie* to our earlier ones, at most they may change our whole way of looking at things.

Page 38

293. Similarly with the sentence "water boils at 100°C."

Page 38

294. This is how we acquire conviction, this is called "being rightly convinced".

Page 38

295. So hasn't one, in this sense, a *proof* of the proposition? But that the same thing has happened again is not a proof of it; though we do say that it gives us a right to assume it.

Page 38

296. This is what we *call* an "empirical foundation" for our assumptions.

Page 38

297. For we learn, not just that such and such experiments had those and those results, but also the conclusion which is drawn. And of course there is nothing wrong in our doing so. For this inferred proposition is an instrument for a definite use.

Page 38

298. 'We are quite sure of it' does not mean just that every single person is certain of it, but that we belong to a community which is bound together by science and education.

Page 38

299. We are satisfied that the earth is round.†1

300. Not all corrections of our views are on the same level.

301. Supposing it wasn't true that the earth had already existed long before I was born--how should we imagine the mistake being discovered?

302. It's no good saying "Perhaps we are wrong" when, if *no* evidence is trustworthy, trust is excluded in the case of the present evidence.

303. If, for example, we have always been miscalculating, and twelve times twelve isn't a hundred and forty-four, why should we trust any other calculation? And of course that is wrongly put.

304. But nor am I *making a mistake* about twelve times twelve being a hundred and forty-four. I may say later that I was confused just now, but not that I was making a mistake.

305. Here *once more* there is needed a step like the one taken in relativity theory.

306. "I don't know if this is a hand." But do you know what the word "hand" means? And don't say "I know what it means now for me". And isn't it an empirical fact--that *this* word is used like *this*?

307. And here the strange thing is that when I am quite certain of how the words are used, have no doubt about it, I can still give no *grounds* for my way of going on. If I tried I could give a thousand, but none as certain as the very thing they were supposed to be grounds for.

308. 'Knowledge' and 'certainty' belong to different *categories*. They are not two 'mental states' like, say 'surmising' and 'being sure'. (Here I assume that it is meaningful for me to say "I know what (e.g.) the word 'doubt' means" and that this sentence indicates that the word "doubt" has a logical role.) What interests us now is not being sure but knowledge. That is, we are interested in the fact that about certain empirical propositions no doubt can exist if making judgments is to be possible at all. Or again: I am inclined to believe that not everything that has the form of an empirical proposition *is* one.

309. Is it that rule and empirical proposition merge into one another?

310. A pupil and a teacher. The pupil will not let anything be explained to him, for he continually interrupts with doubts, for instance as to the existence of things, the meaning of words, etc. The teacher says "Stop interrupting me and do as I tell you. So far your doubts don't make sense at all".

311. Or imagine that the boy questioned the truth of history (and everything that connects up with it)--and even whether the earth had existed at all a hundred years before.

312. Here it strikes me as if this doubt were hollow. But in that case--isn't *belief* in history hollow too? No; there is so much that this connects up with.

313. So is *that* what makes us believe a proposition? Well--the grammar of "believe" just does hang together with the grammar of the proposition believed.

314. Imagine that the schoolboy really did ask "and is there a table there even when I turn round, and even when *no one* is there to see it?" Is the teacher to reassure him--and say "of course there is!"?

Perhaps the teacher will get a bit impatient, but think that the boy will grow out of asking such questions.

315. That is to say, the teacher will feel that this is not really a legitimate question at all.

And it would be just the same if the pupil cast doubt on the uniformity of nature, that is to say on the justification of inductive arguments.--The teacher would feel that this was only holding them up, that this way the pupil would only get stuck and make no progress.--And he would be right. It would be as if someone were looking for some object in a room; he opens a drawer and doesn't see it there; then he closes it again, waits, and opens it once more to see if perhaps it isn't there now, and keeps on like that. He has not learned to look for things. And in the same way this pupil has not learned how to ask questions. He has not learned *the* game that we are trying to teach him.

Page 40

316. And isn't it the same as if the pupil were to hold up his history lesson with doubts as to whether the earth really....?

Page Break 41

Page 41

317. This doubt isn't one of the doubts in our game. (But not as if we *chose* this game!)

Page 41

12.3.51

318. 'The question doesn't arise at all.' Its answer would characterize a *method*. But there is no sharp boundary between methodological propositions and propositions within a method.

Page 41

319. But wouldn't one have to say then, that there is no sharp boundary between propositions of logic and empirical propositions? The lack of sharpness *is* that of the boundary between *rule* and empirical proposition.

Page 41

320. Here one must, I believe, remember that the concept 'proposition' itself is not a sharp one.

Page 41

321. Isn't what I am saying: any empirical proposition can be transformed into a postulate--and then becomes a norm of description. But I am suspicious even of this. The sentence is too general. One almost wants to say "any empirical proposition can, theoretically, be transformed...", but what does "theoretically" mean here? It sounds all too reminiscent of the *Tractatus*.

Page 41

322. What if the pupil refused to believe that this mountain had been there beyond human memory?
We should say that he had no *grounds* for this suspicion.

Page 41

323. So rational suspicion must have grounds?

We might also say: "the reasonable man believes this".

Page 41

324. Thus we should not call anybody reasonable who believed something in despite of scientific evidence.

Page 41

325. When we say that we *know* that such and such..., we mean that any reasonable person in our position would also know it, that it would be a piece of unreason to doubt it. Thus Moore too wants to say not merely that *he* knows that he etc. etc., but also that anyone endowed with reason in his position would know it just the same.

Page 41

326. But who says what it is reasonable to believe in *this* situation?

Page Break 42

Page 42

327. So it might be said: "The reasonable man believes: that the earth has been there since long before his birth, that his life has been spent on the surface of the earth, or near it, that he has never, for example, been on the moon, that he has a nervous system and various innards like all other people, etc., etc."

Page 42

328. "I know it *as* I know that my name is L. W."

Page 42

329. 'If he calls *that* in doubt--whatever "doubt" means here--he will never learn this game!'

Page 42

330. So here the sentence "I know..." expresses the readiness to believe certain things.

Page 42

13.3.

331. If we ever do act with certainty on the strength of belief, should we wonder that there is much we cannot doubt?

Page 42

332. Imagine that someone were to say, without wanting to *philosophize*, "I don't know if I have ever been on the moon; I don't *remember* ever having been there". (Why would this person be so radically different from us?)

In the first place--how would he know that he was on the moon? How does he imagine it? Compare: "I do not know if I was ever in the village of X." But neither could I say that if X were in Turkey, for I know that I was never in Turkey.

Page 42

333. I ask someone "Have you ever been in China?" He replies "I don't know". Here one would surely say "You don't *know*? Have you any reason to believe you might have been there at some time? Were you for example ever near the Chinese border? Or were your parents there at the time when you were going to be born?"--Normally Europeans do know whether they have been in China or not.

Page 42

334. That is to say: only in such-and-such circumstances does a reasonable person doubt *that*.

Page 42

335. The procedure in a court of law rests on the fact that circumstances give statements a certain probability. The statement that, for example, someone came into the world without parents wouldn't ever be taken into consideration there.

Page Break 43

Page 43

336. But what men consider reasonable or unreasonable alters. At certain periods men find reasonable what at other periods they found unreasonable. And vice versa.

But is there no objective character here?

Very intelligent and well-educated people believe in the story of creation in the Bible, while others hold it as proven false, and the grounds of the latter are well known to the former.

Page 43

337. One cannot make experiments if there are not some things that one does not doubt. But that does not mean that one takes certain presuppositions on trust. When I write a letter and post it, I take it for granted that it will arrive--I expect this.

If I make an experiment I do not doubt the existence of the apparatus before my eyes. I have plenty of doubts, but not *that*. If I do a calculation I believe, without any doubts, that the figures on the paper aren't switching of their own accord, and I also trust my memory the whole time, and trust it without any reservation. The certainty here is the same as that of my never having been on the moon.

Page 43

338. But imagine people who were never quite certain of these things, but said that they were *very* probably so, and that it did not pay to doubt them. Such a person, then, would say in my situation: "It is extremely unlikely that I have ever been on the moon", etc., etc. *How* would the life of these people differ from ours? For there *are* people who say that it is merely extremely probable that water over a fire will boil and not freeze, and that therefore strictly speaking what we consider impossible is only improbable. What difference does this make in their lives? Isn't it just that they talk rather more about certain things than the rest of us?

Page 43

339. Imagine someone who is supposed to fetch a friend from the railway station and doesn't simply look the train up in the time-table and go to the station at the right time, but says: "I have *no* belief that the train will really arrive, but I will go to the station all the same." He does everything that the normal person does, but accompanies it with doubts or with self-annoyance, etc.

Page 43

340. We know, with the same certainty with which we believe *any* mathematical proposition, how the letters A and B are

Page Break 44

pronounced, what the colour of human blood is called, that other human beings have blood and call it "blood".

Page 44

341. That is to say, the *questions* that we raise and our *doubts* depend on the fact that some propositions are exempt from doubt, are as it were like hinges on which those turn.

Page 44

342. That is to say, it belongs to the logic of our scientific investigations that certain things are *in deed* not doubted.

Page 44

343. But it isn't that the situation is like this: We just *can't* investigate everything, and for that reason we are forced to rest content with assumption. If I want the door to turn, the hinges must stay put.

Page 44

344. My *life* consists in my being content to accept many things.

Page 44

345. If I ask someone "what colour do you see at the moment?", in order, that is, to learn what colour is there at the moment, I cannot at the same time question whether the person I ask understands English, whether he wants to take me in, whether my own memory is not leaving me in the lurch as to the names of colours, and so on.

Page 44

346. When I am trying to mate someone in chess, I cannot have doubts about the pieces perhaps changing places of themselves and my memory simultaneously playing tricks on me so that I don't notice.

Page 44

15.3.51

347. "I know that that's a tree." Why does it strike me as if I did not understand the sentence? though it is after all an extremely simple sentence of the most ordinary kind? It is as if I could not focus my mind on any meaning. Simply because I don't look for the focus where the meaning is. As soon as I think of an everyday use of the sentence instead of a philosophical one, its meaning becomes dear and ordinary.

Page 44

348. Just as the words "I am here" have a meaning only in certain contexts, and not when I say them to someone who is sitting in front of me and sees me clearly,--and not because they are superfluous, but because their meaning is not *determined* by the situation, yet stands in need of such determination.

Page Break 45

Page 45

349. "I know that that's a tree"--this may mean all sorts of things: I look at a plant that I take for a young beech and that someone else thinks is a black-currant. He says "that is a shrub"; I say it is a tree.--We see something in the mist which one of us takes for a man, and the other says "I know that that's a tree". Someone wants to test my eyes etc. etc.--etc. etc. Each time the 'that' which I declare to be a tree is of a different kind.

But what when we express ourselves more precisely? For example: "I know that that thing there is a tree, I can see it quite clearly."--Let us even suppose I had made this remark in the context of a conversation (so that it was relevant when I made it); and now, out of all context, I repeat it while looking at the tree, and I add "I mean these words as I did five minutes ago". If I added, for example, that I had been thinking of my bad eyes again and it was a kind of sigh, then there would be nothing puzzling about the remark.

For how a sentence is *meant* can be expressed by an expansion of it and may therefore be made part of it.

Page 45

350. "I know that that's a tree" is something a philosopher might say to demonstrate to himself or to someone else that he *knows* something that is not a mathematical or logical truth. Similarly, someone who was entertaining the idea that he was no use any more might keep repeating to himself "I can still do this and this and this". If such thoughts often possessed him one would not be surprised if he, apparently out of all context, spoke such a sentence out loud. (But here I have already sketched a background, a surrounding, for this remark, that is to say given it a context.) But if someone, in quite heterogeneous circumstances, called out with the most convincing mimicry: "Down with him!", one might say of these words (and their tone) that they were a pattern that does indeed have familiar applications, but that in this case it was not even clear what *language* the man in question was speaking. I might make with my hand the movement I should make if I were holding a hand-saw and sawing through a plank; but would one have any right to call this movement *sawing*, out of all context?--(It might be something quite different,)

Page Break 46

Page 46

351. Isn't the question "Have these words a meaning?" similar to "Is that a tool?" asked as one produces, say, a hammer? I say "Yes, it's a hammer". But what if the thing that any of us would take for a hammer were somewhere else a missile, for example, or a conductor's baton? Now make the application yourself.

Page 46

352. If someone says, "I know that that's a tree" I may answer: "Yes, that is a sentence. An English sentence. And what is it supposed to be doing?" Suppose he replies: "I just wanted to remind myself that I *know* things like that"!--

353. But suppose he said "I want to make a logical observation"?--If a forester goes into a wood with his men and says "*This* tree has got to be cut down, and *this* one and *this* one"--what if he then observes "I *know* that that's a tree"?--But might not *I* say of the forester "He *knows* that that's a tree--he doesn't examine it, or order his men to examine it"?

354. Doubting and non-doubting behaviour. There is the first only if there is the second.

355. A mad-doctor (perhaps) might ask me "Do you know what that is?" and I might reply "I know that it's a chair; I recognize it, it's always been in my room". He says this, possibly, to test not my eyes but my ability to recognize things, to know their names and their functions. What is in question here is a kind of knowing one's way about. Now it would be wrong for me to say "I believe that it's a chair" because that would express my readiness for my statement to be tested. While "I know that it..." implies *bewilderment* if what I said was not confirmed.

356. My "mental state", the "knowing", gives me no guarantee of what will happen. But it consists in this, that I should not understand where a doubt could get a foothold nor where a further test was possible.

357. One might say: "I know" expresses *comfortable* certainty, not the certainty that is still struggling."

358. Now I would like to regard this certainty, not as something akin to hastiness or superficiality, but as a form of life. (That is very badly expressed and probably badly thought as well.)

359. But that means I want to conceive it as something that lies beyond being justified or unjustified; as it were, as something animal.

360. I KNOW that this is my foot. I could not accept any experience as proof to the contrary.--That may be an exclamation; but what *follows* from it? At least that I shall act with a certainty that knows no doubt, in accordance with my belief.

361. But I might also say: It has been revealed to me by God that it is so. God has taught me that this is my foot. And therefore if anything happened that seemed to conflict with this knowledge I should have to regard *that* as deception.

362. But doesn't it come out here that knowledge is related to a decision?

363. And here it is difficult to find the transition from the exclamation one would like to make, to its consequences in what one does.

364. One might also put this question: "If you know that that is your foot,--do you also know, or do you only believe, that no future experience will seem to contradict your knowledge?" (That is, that nothing will seem to *you yourself* to do so.)

365. If someone replied: "I also know that it will never *seem* to me as if anything contradicted that knowledge",--what could we gather from that, except that he himself had no doubt that it would never happen?--

366. Suppose it were forbidden to say "I know" and only allowed to say "I believe I know"?

367. Isn't it the purpose of construing a word like "know" analogously to "believe" that then opprobrium attaches to the statement "I know" if the person who makes it is wrong?

As a result a mistake becomes something forbidden.

368. If someone says that he will recognize no experience as proof of the opposite, that is after all a *decision*. It is possible that he will act against it.

Page 48

16.3.51

369. If I wanted to doubt whether this was my hand, how could I avoid doubting whether the word "hand" has any meaning? So that is something I seem to *know* after all.

Page 48

370. But more correctly: The fact that I use the word "hand" and all the other words in my sentence without a second thought, indeed that I should stand before the abyss if I wanted so much as to try doubting their meanings--shews that absence of doubt belongs to the essence of the language-game, that the question "How do I know..." drags out the language-game, or else does away with it.

Page 48

371. Doesn't "I know that that's a hand", in Moore's sense, mean the same, or more or less the same, as: I can make statements like "I have a pain in this hand" or "this hand is weaker than the other" or "I once broke this hand", and countless others, in language-games where a doubt as to the existence of this hand does not come in?

Page 48

372. Only in certain cases is it possible to make an investigation "is that really a hand?" (or "my hand"). For "I doubt whether that is really my (or a) hand" makes no sense without some more precise determination. One cannot tell from these words alone whether any doubt at all is meant--nor what kind of doubt.

Page 48

373. Why is it supposed to be possible to have grounds for *believing* something if it isn't possible to be certain?

Page 48

374. We teach a child "that is your hand", not "that is perhaps (or "probably") your hand". That is how a child learns the innumerable language-games that are concerned with his hand. An investigation or question, 'whether this is really a hand' never occurs to him. Nor, on the other hand, does he learn that he *knows* that this is a hand.

Page 48

375. Here one must realize that complete absence of doubt at some point, even where we would say that 'legitimate' doubt can exist, need not falsify a language-game. For there is also something like *another* arithmetic.

I believe that this admission must underlie any understanding of logic.

Page Break 49

Page 49

17.3.

376. I may claim with passion that I know that this (for example) is my foot.

Page 49

377. But this passion is after all something very rare, and there is no trace of it when I talk of this foot in the ordinary way.

Page 49

378. Knowledge is in the end based on acknowledgement.

Page 49

379. I say with passion "I *know* that this is a foot"--but what does it *mean*?

Page 49

380. I might go on: "Nothing in the world will convince me of the opposite!" For me this fact is at the bottom of all knowledge. I shall give up other things but not this.

Page 49

381. This "Nothing in the world" is obviously an attitude which one hasn't got towards everything one believes or is certain of.

Page 49

382. That is not to say that nothing in the world will in fact be able to convince me of anything else.

Page 49

383. The argument "I may be dreaming" is senseless for this reason: if I am dreaming, this remark is being dreamed as well--and indeed it is also being dreamed that these words have any meaning.

Page 49

384. Now what kind of sentence is "Nothing in the world..."?

Page 49

385. It has the form of a prediction, but of course it is not one that is based on experience.

Page 49

386. Anyone who says, with Moore, that he knows that so and so...--gives the degree of certainty that something has for him. And it is important that this degree has a maximum value.

387. Someone might ask me: "How certain are you that that is a tree over there; that you have money in your pocket; that that is your foot?" And the answer in one case might be "not certain", in another "as good as certain", in the third "I can't doubt it". And these answers would make sense even without any grounds. I should not need, for example, to say: "I can't be certain whether that is a tree because my eyes aren't sharp enough". I want to

say: it made sense for Moore to say "I *know* that that is a tree", if he meant something quite particular by it.

[I believe it might interest a philosopher, one who can think himself, to read my notes. For even if I have hit the mark only rarely, he would recognize what targets I had been ceaselessly aiming at.]

388. Every one of us often uses such a sentence, and there is no question but that it makes sense. But does that mean it yields any philosophical conclusion? Is it more of a proof of the existence of external things, that I know that this is a hand, than that I don't know whether that is gold or brass?

18.3.

389. Moore wanted to give an example to shew that one really can *know* propositions about physical objects.--If there were a dispute whether one could have a pain in such and such a part of the body, then someone who just then had a pain in that spot might say: "I assure you, I have a pain there now." But it would sound odd if Moore had said: "I assure you, I know that's a tree." A personal experience simply has no interest for us here.

390. All that is important is that it makes sense to say that one knows such a thing; and consequently the assurance that one does know it can't accomplish anything here.

391. Imagine a language-game "When I call you, come in through the door". In any ordinary case, a doubt whether there really is a door there will be impossible.

392. What I need to shew is that a doubt is not necessary even when it is possible. That the possibility of the language-game doesn't depend on everything being doubted that can be doubted. (This is connected with the role of contradiction in mathematics.)

393. The sentence "I know that that's a tree" if it were said outside its language-game, might also be a quotation (from an English grammar-book perhaps).--"But suppose I *mean* it while I am saying it?" The old misunderstanding about the concept 'mean'.

394. "This is one of the things that I cannot doubt."

395. "I know all that." And that will come out in the way I act and in the way I speak about the things in question.

396. In the language-game (2),[†]1 can he say that he knows that those are building stones? "No, but he *does* know it."

397. Haven't I gone wrong and isn't Moore perfectly right? Haven't I made the elementary mistake of confusing one's thoughts with one's knowledge? Of course I do not think to myself "The earth already existed for some time before my birth", but do I *know* it any the less? Don't I show that I know it by always drawing its consequences)

398. And don't I know that there is no stairway in this house going six floors deep into the earth, even though I have never thought about it?

399. But doesn't my drawing the consequences only show that I accept this hypothesis?

19.3.

400. Here I am inclined to fight windmills, because I cannot yet say the thing I really want to say.

401. I want to say: propositions of the form of empirical propositions, and not only propositions of logic, form the

foundation of all operating with thoughts (with language).--This observation is not of the form "I know...". "I know..." states what *I* know, and that is not of logical interest.

Page 51

402. In this remark the expression "propositions of the form of empirical propositions" is itself thoroughly bad; the statements in question are statements about material objects. And they do not serve as foundations in the same way as hypotheses which, if they turn out to be false, are replaced by others.

(. . . und schreib getrost
"Im Anfang war die Tat.")

(...und schreib getrost)
("Im Anfang war die Tat."†2)

Page Break 52

Page 52

403. To say of man, in Moore's sense, that he *knows* something; that what he says is therefore unconditionally the truth, seems wrong to me.--It is the truth only inasmuch as it is an unmoving foundation of his language-games.

Page 52

404. I want to say: it's not that on some points men know the truth with perfect certainty. No: perfect certainty is only a matter of their attitude.

Page 52

405. But of course there is still a mistake even here.

Page 52

406. What I am aiming at is also found in the difference between the casual observation "I know that that's a...", as it might be used in ordinary life, and the same utterance when a philosopher makes it.

Page 52

407. For when Moore says "I know that that's..." I want to reply "you don't *know* anything!"--and yet I would not say that to anyone who was speaking without philosophical intention. That is, I feel (rightly?) that these two mean to say something different.

Page 52

408. For if someone says he knows such-and-such, and this is part of his philosophy--then his philosophy is false if he has slipped up in this statement.

Page 52

409. If I say "I know that that's a foot"--what am I really saying? Isn't the whole point that I am certain of the consequences--that if someone else had been in doubt I might say to him "you see--I told you so"? Would my knowledge still be worth anything if it let me down as a clue in action? And *can't* it let me down?

Page 52

20.3.

410. Our knowledge forms an enormous system. And only within this system has a particular bit the value we give it.

Page 52

411. If I say "*we assume* that the earth has existed for many years past" (or something similar), then of course it sounds strange that we should *assume* such a thing. But in the entire system of our language-games it belongs to the foundations. The assumption, one might say, forms the basis of action, and therefore, naturally, of thought.

Page Break 53

Page 53

412. Anyone who is unable to imagine a case in which one might say "I know that this is my hand" (and such cases are certainly rare) might say that these words were nonsense. True, he might also say "Of course I know--how could I not know?"--but then he would possibly be taking the sentence "this is my hand" as an *explanation* of the words "my hand".

Page 53

413. For suppose you were guiding a blind man's hand, and as you were guiding it along yours you said "this is my hand"; if he then said "are you sure?" or "do you know it is?", it would take very special circumstances for that to make sense.

Page 53

414. But on the other hand: how do I *know* that it is my hand? Do I even here know exactly what it means to say it is

my hand?--When I say "how do I know?" I do not mean that I have the least *doubt* of it. What we have here is a foundation for all my action. But it seems to me that it is wrongly expressed by the words "I know".

Page 53

415. And in fact, isn't the use of the word "know" as a preeminently philosophical word altogether wrong? If "know" has this interest, why not "being certain"? Apparently because it would be too subjective. But isn't "know" *just* as subjective? Isn't one misled simply by the grammatical peculiarity that "p" follows from "I know p"?

"I believe I know" would not need to express a lesser degree of certainty.--True, but one isn't trying to express even the greatest subjective certainty, but rather that certain propositions seem to underlie all questions and all thinking.

Page 53

416. And have we an example of this in, say, the proposition that I have been living in this room for weeks past, that my memory does not deceive me in this?

--"certain beyond all reasonable doubt"--

Page 53

21.3.

417. "I know that for the last month I have had a lath every day." What am I remembering? Each day and the bath each morning? No. I *know* that I bathed each day and I do not derive that from some other immediate datum. Similarly I say "I felt a

Page Break 54

pain in my arm" without this locality coming into my consciousness in any other way (such as by means of an image).

Page 54

418. Is my understanding only blindness to my own lack of understanding? It often seems so to me.

Page 54

419. If I say "I have never been in Asia Minor", where do I get this knowledge from? I have not worked it out, no one told me; my memory tells me.--So I can't be wrong about it? Is there a truth here which I *know*?--I cannot depart from this judgment without toppling all other judgments with it.

Page 54

420. Even a proposition like this one, that I am now living in England, has these two sides: it is not a *mistake*--but on the other hand, what do I know of England? Can't my judgment go all to pieces?

Would it not be possible that people came into my room and all declared the opposite?--even gave me 'proofs' of it, so that I suddenly stood there like a madman alone among people who were all normal, or a normal person alone among madmen? Might I not then suffer doubts about what at present seems at the furthest remove from doubt?

Page 54

421. I am in England.--Everything around me tells me so; wherever and however I let my thoughts turn, they confirm this for me at once.--But might I not be shaken if things such as I don't dream of at present were to happen?

Page 54

422. So I am trying to say something that sounds like pragmatism.

Here I am being thwarted by a kind of *Weltanschauung*.

Page 54

423. Then why don't I simply say with Moore "I *know* that I am in England"? Saying this is meaningful *in particular circumstances*, which I can imagine. But when I utter the sentence outside these circumstances, as an example to shew that I can know truths of this kind with certainty, then it at once strikes me as fishy.--Ought it to?

Page 54

424. I say "I know p" either to assure people that I, too, know the truth p, or simply as an emphasis of $\vdash p$. One says,

Page Break 55

too, "I don't *believe* it, I *know* it". And one might also put it like this (for example): "That is a tree. And that's not just surmise."

But what about this: "If I were to tell someone that that was a tree, that wouldn't be just surmise." Isn't this what Moore was trying to say?

Page 55

425. It would not be surmise and I might tell it to someone else with complete certainty, as something there is no doubt about. But does that mean that it is unconditionally the truth? May not the thing that I recognize with

complete certainty as the tree that I have seen here my whole life long--may this not be disclosed as something different? May it not confound me?

And nevertheless it was right, in the circumstances that give this sentence meaning, to say "I know (I do not merely surmise) that that's a tree". To say that in strict truth I only believe it, would be wrong. It would be completely *misleading* to say: "I believe my name is L. W." And this too is right: I cannot be making a *mistake* about it. But that does not mean that I am infallible about it.

Page 55

21.3.51

426. But how can we *show* someone that we *know* truths, not only about sense-data but also about things? For after all it can't be enough for someone to assure us that *he* knows this.

Well, what must our starting point be if we are to shew this?

Page 55

22.3.

427. We need to shew that even if he never uses the words "I know...", his conduct exhibits the thing we are concerned with.

Page 55

428. For suppose a person of normal behaviour assured us that he only *believed* his name was such-and-such, he *believed* he recognized the people he regularly lived with, he believed that he had hands and feet when he didn't actually see them, and so on. Can we shew him it is not so from the things he does (and says)?

Page 55

23.3.51

429. What reason have I, now, when I cannot see my toes, to assume that I have five toes on each foot?

Page Break 56

Page 56

Is it right to say that my reason is that previous experience has always taught me so? Am I more certain of previous experience than that I have ten toes?

That previous experience may very well be the *cause* of my present certitude; but is it its ground?

Page 56

430. I meet someone from Mars and he asks me "How many toes have human beings got?"--I say "Ten. I'll shew you", and take my shoes off. Suppose he was surprised that I knew with such certainty, although I hadn't looked at my toes--ought I to say: "We humans know how many toes we have whether we can see them or not"?

Page 56

26.3.

431. "I know that this room is on the second floor, that behind the door a short landing leads to the stairs, and so on." One could imagine cases where I should come out with this, but they would be extremely rare. But on the other hand I shew this knowledge day in, day out by my actions and also in what I say.

Now what does someone else gather from these actions and words of mine? Won't it be just that I am sure of my ground?--From the fact that I have been living here for many weeks and have gone up and down the stairs every day he will gather that I know where my room is situated.--I shall give him the assurance "I know" when he does *not* already know things which would have compelled the conclusion that I knew.

Page 56

432. The utterance "I know..." can only have its meaning in connection with the other evidence of my 'knowing'.

Page 56

433. So if I say to someone "I *know* that that's a tree", it is as if I told him "that is a tree; you can absolutely rely on it; there is no doubt about it". And a philosopher could only use the statement to show that this form of speech is actually used. But if his use of it is not to be merely an observation about English grammar, he must give the circumstances in which this expression functions.

Page 56

434. Now does *experience* teach us that in such-and-such circumstances people know this and that? Certainly, experience shews us that normally after so-and-so many days a man can find his way about a house he has been living in. Or even: experience

Page Break 57

teaches us that after such-and-such a period of training a man's judgment is to be trusted. He must, experience tells us, have learnt for so long in order to be able to make a correct prediction. But-- -- --

Page 57

27.3.

435. One is often bewitched by a word. For example, by the word "know".

Page 57

436. Is God bound by our knowledge? Are a lot of our statements *incapable* of falsehood? For that is what we want to say.

Page 57

437. I am inclined to say: "That *cannot* be false." That is interesting; but what consequences has it?

Page 57

438. It would not be enough to assure someone that I know what is going on at a certain place--without giving him grounds that satisfy him that I am in a position to know.

Page 57

439. Even the statement "I know that behind this door there is a landing and the stairway down to the ground floor" only sounds so convincing because everyone takes it for granted that I know it.

Page 57

440. There is something universal here; not just something personal.

Page 57

441. In a court of law the mere assurance "I know..." on the part of a witness would convince no one. It must be shown that he was in a position to know.

Even the assurance "I know that that's a hand", said while someone looked at his own hand, would not be credible unless we knew the circumstances in which it was said. And if we do know them, it seems to be an assurance that the person speaking is normal in this respect.

Page 57

442. For may it not happen that I *imagine* myself to *know* something?

Page 57

443. Suppose that in a certain language there were no word corresponding to our "know".--The people simply make assertions. ("That is a tree", etc.) Naturally it can occur for them to make mistakes. And so they attach a sign to the sentence which indicates how probable they take a mistake to be--or should I say, how probable a mistake is in this case? This latter can also

Page Break 58

be indicated by mentioning certain circumstances. For example "Then A said to B '...'. I was standing quite close to them and my hearing is good", or "A was at such-and-such a place yesterday. I saw him from a long way off. My eyes are not very good", or "There is a tree over there: I can see it clearly and I have seen it innumerable times before".

Page 58

444. "The train leaves at two o'clock. Check it once more to make certain" or "The train leaves at two o'clock. I have just looked it up in a new time-table". One may also add "I am reliable in such matters". The usefulness of such additions is obvious.

Page 58

445. But if I say "I have two hands", what can I add to indicate reliability? At the most that the circumstances are the ordinary ones.

Page 58

446. But why *am* I so certain that this is my hand? Doesn't the whole language-game rest on this kind of certainty?

Or: isn't this 'certainty' (already) presupposed in the language-game? Namely by virtue of the fact that one is not playing the game, or is playing it wrong, if one does not recognize objects with certainty.

Page 58

28.3.

447. Compare with this $12 \times 12 = 144$. Here too we don't say "perhaps". For, in so far as this proposition rests on our not miscounting or miscalculating and on our senses not deceiving us as we calculate, both propositions, the arithmetical one and the physical one, are on the same level.

I want to say: The physical game is just as certain as the arithmetical. But this can be misunderstood. My remark is a logical and not a psychological one.

Page 58

448. I want to say: If one doesn't marvel at the fact that the propositions of arithmetic (e.g. the multiplication tables) are 'absolutely certain', then why should one be astonished that the proposition "This is my hand" is so equally?

Page 58

449. Something must be taught us as a foundation.

450. I want to say: our learning has the form "that is a violet", "that is a table". Admittedly, the child might hear the word "violet" for the first time in the sentence "perhaps that is a

violet", but then he could ask "what is a violet?" Now this might of course be answered by showing him a picture. But how would it be if one said "that is a..." only when showing him a picture, but otherwise said nothing but "perhaps that is a..."--What practical consequences is that supposed to have?

A doubt that doubted everything would not be a doubt.

451. My objection against Moore, that the meaning of the isolated sentence "That is a tree" is undetermined, since it is not determined what the "that" is that is said to be a tree--doesn't work, for one can make the meaning more definite by saying, for example: "The object over there that looks like a tree is not an artificial imitation of a tree but a real one."

452. It would not be reasonable to doubt if that was a real tree or only.

My finding it beyond doubt is not what counts. If a doubt would be unreasonable, that cannot be seen from what *I* hold. There would therefore have to be a rule that declares doubt to be unreasonable here. But there isn't such a rule, either.

453. I do indeed say: "Here no reasonable person would doubt."--Could we imagine learned judges being asked whether a doubt was reasonable or unreasonable?

454. There are cases where doubt is unreasonable, but others where it seems logically impossible. And there seems to be no clear boundary between them.

29.3.

455. Every language-game is based on words 'and objects' being recognized again. We learn with the same inexorability that this is a chair as that $2 \times 2 = 4$.

456. If, therefore, I doubt or am uncertain about this being my hand (in whatever sense), why not in that case about the meaning of these words as well?

457. Do I want to say, then, that certainty resides in the nature of the language-game?

458. One doubts on specific grounds. The question is this: how is doubt introduced into the language-game?

459. If the shopkeeper wanted to investigate each of his apples without any reason, for the sake of being certain about everything, why doesn't he have to investigate the investigation? And can one talk of belief here (I mean belief as in 'religious belief', not surmise)? All psychological terms merely distract us from the thing that really matters.

460. I go to the doctor, shew him my hand and say "This is a hand, not...; I've injured it, etc., etc." Am I only giving him a piece of superfluous information? For example, mightn't one say: supposing the words "This is a hand" were a piece of information--how could you bank on his understanding this information? Indeed, if it is open to doubt 'whether that is a hand', why isn't it also open to doubt whether I am a human being who is informing the doctor of this?--But on the other hand one can imagine cases--even if they are very rare ones--where this declaration is not superfluous, or is only superfluous but not absurd.

461. Suppose that I were the doctor and a patient came to me, showed me his hand and said: "This thing that looks like a hand isn't just a superb imitation--it really is a hand" and went on to talk about his injury--should I really take this as a piece of information, even though a superfluous one? Shouldn't I be more likely to consider it nonsense, which admittedly did have the form of a piece of information? For, I should say, if this information really were meaningful, how can he be certain of what he says? The background is lacking for it to be information.

30.3.

462. Why doesn't Moore produce as one of the things that he knows, for example, that in such-and-such a part of England there is a village called so-and-so? In other words: why doesn't he mention a fact that is known to him and not to *every one* of us;'

Page 60

31.3.

463. This is certainly true, that the information "That is a tree", when no one could doubt it, might be a kind of joke and as such

Page Break 61

have meaning. A joke of this kind was in fact made once by Renan.

Page 61

3.4.51

464. My difficulty can also be shewn like this: I am sitting talking to a friend. Suddenly I say: "I knew all along that you were so-and-so." Is that really just a superfluous, though true, remark?

I feel as if these words were like "Good morning" said to someone in the middle of a conversation.

Page 61

465. How would it be if we had the words "They know nowadays that there are over... species of insects" instead of "I know that that's a tree"? If someone were suddenly to utter the first sentence out of all context one might think: he has been thinking of something else in the interim and is now saying out loud some sentence in his train of thought. Or again: he is in a trance and is speaking without understanding what he is saying.

Page 61

466. Thus it seems to me that I have known something the whole time, and yet there is no meaning in saying so, in uttering this truth.

Page 61

467. I am sitting with a philosopher in the garden; he says again and again "I know that that's a tree", pointing to a tree that is near us. Someone else arrives and hears this, and I tell him: "This fellow isn't insane. We are only doing philosophy."

Page 61

4.4.

468. Someone says irrelevantly "That's a tree". He might say this sentence because he remembers having heard it in a similar situation; or he was suddenly struck by the tree's beauty and the sentence was an exclamation; or he was pronouncing the sentence to himself as a grammatical example; etc., etc. And now I ask him "How did you mean that?" and he replies "It was a piece of information directed at you". Shouldn't I be at liberty to assume that he doesn't know what he is saying, if he is insane enough to want to give me this information?

Page 61

469. In the middle of a conversation, someone says to me out of the blue: "I wish you luck." I am astonished; but later I

Page Break 62

realize that these words connect up with his thoughts about me. And now they do not strike me as meaningless any more.

Page 62

470. Why is there no doubt that I am called L. W.? It does not seem at all like something that one could establish at once beyond doubt. One would not think that it is one of the indubitable truths.

Page 62

5.4.

[Here there is still a big gap in my thinking. And I doubt whether it will be filled now.]

Page 62

471. It is so difficult to find the *beginning*. Or, better: it is difficult to begin at the beginning. And not try to go further back.

Page 62

472. When a child learns language it learns at the same time what is to be investigated and what not. When it learns that there is a cupboard in the room, it isn't taught to doubt whether what it sees later on is still a cupboard or only a kind of stage set.

Page 62

473. Just as in writing we learn a particular basic form of letters and then vary it later, so we learn first the stability of things as the norm, which is then subject to alterations.

Page 62

474. This game proves its worth. That may be the cause of its being played, but it is not the ground.

Page 62

475. I want to regard man here as an animal; as a primitive being to which one grants instinct but not ratiocination. As a creature in a primitive state. Any logic good enough for a primitive means of communication needs no apology from us. Language did not emerge from some kind of ratiocination.

Page 62

6.4.

476. Children do not learn that books exist, that armchairs exist, etc. etc.,--they learn to fetch books, sit in armchairs, etc. etc.

Later, questions about the existence of things do of course arise. "Is there such a thing as a unicorn?" and so on. But such a question is possible only because as a rule no corresponding question presents itself. For how does one know how to set

Page Break 63

about satisfying oneself of the existence of unicorns? How did one learn the method for determining whether something exists or not?

Page 63

477. "So one must know that the objects whose names one teaches a child by an ostensive definition exist."-Why must one know they do? Isn't it enough that experience doesn't later show the opposite?

For why should the language-game rest on some kind of knowledge?

Page 63

7.4.

478. Does a child believe that milk exists? Or does it know that milk exists? Does a cat know that a mouse exists?

Page 63

479. Are we to say that the knowledge that there are physical objects comes very early or very late?

Page 63

8.4.

480. A child that is learning to use the word "tree". One stands with it in front of a tree and says "*Lovely tree!*" Clearly no doubt as to the tree's existence comes into the language-game. But can the child be said to *know*: 'that a tree exists'? Admittedly it's true that 'knowing something' doesn't involve *thinking* about it--but mustn't anyone who knows something be capable of doubt? And doubting means thinking.

Page 63

481. When one hears Moore say "*I know* that that's a tree", one suddenly understands those who think that that has by no means been settled.

The matter strikes one all at once as being unclear and blurred. It is as if Moore had put it in the wrong light.

It is as if I were to see a painting (say a painted stage-set) and recognize what it represents from a long way off at once and without the slightest doubt. But now I step nearer: and then I see a lot of patches of different colours, which are all highly ambiguous and do not provide any certainty whatever.

Page 63

482. It is as if "I know" did not tolerate a metaphysical emphasis.

Page 63

483. The correct use of the expression "I know". Someone with bad sight asks me: "do you believe that the thing we can see there is a tree?" I reply "*I know* it is; I can see it clearly and am familiar

Page Break 64

with it."--A: "Is N. N. at home?"--I: "I believe he is."--A: "Was he at home yesterday?"--I: "Yesterday he was--I know he was; I spoke to him."--A: "Do you know or only believe that this part of the house is built on later than the rest?"--I: "*I know* it is; I got it from so and so."

Page 64

484. In these cases, then, one says "I know" and mentions how one knows, or at least one can do so.

Page 64

485. We can also imagine a case where someone goes through a list of propositions and as he does so keeps asking "Do I know that or do I only believe it?" He wants to check the certainty of each individual proposition. It might be a question of making a statement as a witness before a court.

Page 64

9.4.

486. "Do you know or do you only believe that your name is L. W.?" Is that a meaningful question?

Do you know or do you only believe that what you are writing down now are German words? Do you only believe that "believe" has *this* meaning? *What* meaning?

Page 64

487. What is the proof that I *know* something? Most certainly not my saying I know it.

Page 64

488. And so, when writers enumerate all the things they *know*, that proves nothing whatever.

So the possibility of knowledge about physical objects cannot be proved by the protestations of those who believe that they have such knowledge.

Page 64

489. For what reply does one make to someone who says "I believe it merely strikes you as if you knew it"?

Page 64

490. When I ask "Do I know or do I only believe that I am called...?" it is no use to look within myself.

But I could say: not only do I never have the slightest doubt that I am called that, but there is no judgment I could be certain of if I started doubting about that.

Page 64

10.4.

491. "Do I know or do I only believe that I am called L. W.?"--Of course, if the question were "Am I certain or do I only surmise...?", then my answer could be relied on.

Page Break 65

Page 65

492. "Do I know or do I only believe...?" might also be expressed like this: What if it *seemed* to turn out that what until now has seemed immune to doubt was a false assumption? Would I react as I do when a belief has proved to be false? or would it seem to knock from under my feet the ground on which I stand in making any judgments at all?--But of course I do not intend this as a *prophecy*.

Would I simply say "I should never have thought it!"--or would I (have to) refuse to revise my judgment--because such a 'revision' would amount to annihilation of all yardsticks?

Page 65

493. So is this it: I must recognize certain authorities in order to make judgments at all?

Page 65

494. "I cannot doubt this proposition without giving up all judgment."

But what sort of proposition is that? (It is reminiscent of what Frege said about the law of identity.†1) It is certainly no empirical proposition. It does not belong to psychology. It has rather the character of a rule.

Page 65

495. One might simply say "O, rubbish" to someone who wanted to make objections to the propositions that are beyond doubt. That is, not reply to him but admonish him.

Page 65

496. This is a similar case to that of shewing that it has no meaning to say that a game has always been played wrong.

Page 65

497. If someone wanted to arouse doubts in me and spoke like this: here your memory is deceiving you, there you've been taken in, there again you have not been thorough enough in satisfying yourself, etc., and if I did not allow myself to be shaken but kept to my certainty--then my doing so cannot be wrong, even if only because this is just what defines a game.

Page 65

11.4.

498. The queer thing is that even though I find it quite correct for someone to say "Rubbish" and so brush aside the attempt to confuse him with doubts at bedrock,--nevertheless, I hold it to be incorrect if he seeks to defend himself (using, e.g., the words "I know").

Page Break 66

Page 66

499. I might also put it like this: the 'law of induction' can no more be *grounded* than certain particular propositions concerning the material of experience.

Page 66

500. But it would also strike me as nonsense to say "I know that the law of induction is true".

Imagine such a statement made in a court of law! It would be more correct to say "I believe in the law of..." where 'believe' has nothing to do with *surmising*.

Page 66

501. Am I not getting closer and closer to saying that in the end logic cannot be described? You must look at the practice of language, then you will see it.

Page 66

502. Could one say "I know the position of my hands with my eyes closed", if the position I gave always or mostly contradicted the evidence of other people?

Page 66

503. I look at an object and say "That is a tree", or "I know that that's a tree".--Now if I go nearer and it turns out that it isn't, I may say "It wasn't a tree after all" or alternatively I say "It *was* a tree but now it isn't any longer". But if all the others contradicted me, and said it never had been a tree, and if all the other evidences spoke against me--what *good* would it do me to stick to my "I know"?

Page 66

504. Whether *I know* something depends on whether the evidence backs me up or contradicts me. For to say one knows one has a pain means nothing.

Page 66

505. It is always by favour of Nature that one knows something.

Page 66

506. "If my memory deceives me *here* it can deceive me everywhere."

If I don't know *that*, how do I know if my words mean what I believe they mean?

Page 66

507. "If this deceives me, what does 'deceive' mean anymore?"

Page 66

508. What can I rely on?

Page 66

509. I really want to say that a language-game is only possible if one trusts something (I did not say "can trust something").

Page Break 67

Page 67

510. If I say "Of course I know that that's a towel" I am making an *utterance*.†1 I have no thought of a verification. For me it is an immediate utterance.

I don't think of past or future. (And of course it's the same for Moore, too.)

It is just like directly taking hold of something, as I take hold of my towel without having doubts.

Page 67

511. And yet this direct taking-hold corresponds to a *sureness*, not to a knowing.

But don't I take hold of a thing's name like that, too?

Page 67

12.4.

512. Isn't the question this: "What if you had to change your opinion even on these most fundamental things?" And to that the answer seems to me to be: "You don't *have* to change it. That is just what their being 'fundamental' is."

Page 67

513. What if something *really unheard-of* happened?--If I, say, saw houses gradually turning into steam without any obvious cause, if the cattle in the fields stood on their heads and laughed and spoke comprehensible words; if trees gradually changed into men and men into trees. Now, was I right when I said before all these things happened "I know that that's a house" etc., or simply "that's a house" etc.?

Page 67

514. This statement appeared to me fundamental; if it is false, what are 'true' or 'false' any more?!

Page 67

515. If my name is *not* L. W., how can I rely on what is meant by "true" and "false"?

Page 67

516. If something happened (such as someone telling me something) calculated to make me doubtful of my own name, there would certainly also be something that made the grounds of these doubts themselves seem doubtful, and I could therefore decide to retain my old belief.

Page 67

517. But might it not be possible for something to happen that threw me entirely off the rails? Evidence that made the most certain thing unacceptable to me? Or at any rate made me throw

Page Break 68

over my most fundamental judgments? (Whether rightly or wrongly is beside the point.)

Page 68

518. Could I imagine observing this in another person?

Page 68

519. Admittedly, if you are obeying the order "Bring me a book", you may have to check whether the thing you see over there really is a book, but then you do at least know what people mean by "book"; and if you don't you can look it up,--but then you must know what some other word means. And the fact that a word means such-and-such, is used in such-and-such a way, is in turn an empirical fact, like the fact that what you see over there is a book.

Therefore, in order for you to be able to carry out an order there must be some empirical fact about which you are not in doubt. Doubt itself rests only on what is beyond doubt.

Page 68

But since a language-game is something that consists in the recurrent procedures of the game in time, it seems impossible to say in any *individual* case that such-and-such must be beyond doubt if there is to be a language-game--though it is right enough to say that *as a rule* some empirical judgment or other must be beyond doubt.

Page 68

13.4.

520. Moore has every right to say he knows there's a tree there in front of him. Naturally he may be wrong. (For it is *not* the same as with the utterance "I believe there is a tree there".) But whether he is right or wrong in this case is of no philosophical importance. If Moore is attacking those who say that one cannot really know such a thing, he can't do it by assuring them that *he* knows this and that. For one need not believe him. If his opponents had asserted that one could not *believe* this and that, then he could have replied: "I believe it."

Page 68

14.4.

Page 68

521. Moore's mistake lies in this--countering the assertion that one cannot know that, by saying "I do know it".

Page 68

522. We say: if a child has mastered language--and hence its application--it must know the meaning of words. It must, for

Page Break 69

example, be able to attach the name of its colour to a white, black, red or blue object without the occurrence of any doubt.

Page 69

523. And indeed no one misses doubt here; no one is surprised that we do not merely *surmise* the meaning of our words.

Page 69

15.4.

524. Is it essential for our language-games ('ordering and obeying' for example) that no doubt appears at certain points, or is it enough if there is the feeling of being sure, admittedly with a slight breath of doubt?

That is, is it enough if I do not, as I do now, call something 'black', 'green', 'red', *straight off*, without any doubt at all interposing itself--but do instead say "I am sure that that is red", as one may say "I am sure that he will come today" (in other words with the 'feeling of being sure')?

The accompanying feeling is of course a matter of indifference to us, and equally we have no need to bother about the words "I am sure that" either.--What is important is whether they go with a difference in the *practice* of the language.

One might ask whether a person who spoke like this would always say "I am sure" on occasions where (for example) there is sureness in the reports we make (in an experiment, for example, we look through a tube and report the colour we see through it). If he does, our immediate inclination will be to check what he says. But if he proves to be perfectly reliable, one will say that his way of talking is merely a bit perverse, and does not affect the issue. One might for example suppose that he has read sceptical philosophers, become convinced that one can know nothing, and that is why he has adopted this way of speaking. Once we are used to it, it does not infect practice.

525. What, then, does the case look like where someone really has got a different relationship to the names of colours, for example, from us? Where, that is, there persists a slight doubt or a possibility of doubt in their use.

16.4.

526. If someone were to look at an English pillar-box and say "I am sure that it's red", we should have to suppose that he was

colour-blind, or believe he had no mastery of English and knew the correct name for the colour in some other language.

If neither was the case we should not quite understand him.

527. An Englishman who calls this colour "red" is not 'sure it is called "red" in English'.

A child who has mastered the use of the word is not 'sure that in his language this colour is called...'. Nor can one say of him that when he is learning to speak he learns that the colour is called that in English; nor yet: he *knows* this when he has learnt the use of the word.

528. And in spite of this: if someone asked me what the colour was called in German and I tell him, and now he asks me "are you sure?"--then I shall reply "I *know* it is; German is my mother tongue".

529. And one child, for example, will say, of another or of himself, that he already knows what such-and-such is called.

530. I may tell someone "this colour is called 'red' in English" (when for example I am teaching him English). In this case I should not say "I know that this colour..."--I would perhaps say that if I had just now learned it, or by contrast with another colour whose English name I am not acquainted with.

531. But now, isn't it correct to describe my present state as follows: I *know* what this colour is called in English? And if that is correct, why then should I not describe my state with the corresponding words "I know etc."?

532. So when Moore sat in front of a tree and said "I know that that's a tree", he was simply stating the truth about his state at the time.

[I do philosophy now like an old woman who is always mislaying something and having to look for it again: now her spectacles, now her keys.]

533. Well, if it was correct to describe his state out of context, then it was just as correct to utter the words "that's a tree" out of context.

534. But is it wrong to say: "A child that has mastered a language-game must *know* certain things"?

If instead of that one said "must be *able to do* certain things", that would be a pleonasm, yet this is just what I want to counter the first sentence with.--But: "a child acquires a knowledge of natural history". That presupposes that it can ask what such and such a plant is called.

535. The child knows what something is called if he can reply correctly to the question "what is that called?"

536. Naturally, the child who is just learning to speak has not yet got the concept *is called* at all.

537. Can one say of someone who hasn't this concept that he *knows* what such-and-such is called?

538. The child, I should like to say, learns to react in such-and-such a way; and in so reacting it doesn't so far know anything. Knowing only begins at a later level.

539. Does it go for knowing as it does for collecting?

540. A dog might learn to run to N at the call "N", and to M at the call "M",--but would that mean he knows what these people are called?

Page 71

541. "He only knows what this person is called--not yet what that person is called". That is something one cannot, strictly speaking, say of someone who simply has not yet got the concept of people's having names.

Page 71

542. "I can't describe this flower if I don't know that this colour is called 'red'."

Page 71

543. A child can use the names of people long before he can say in any form whatever: "I know this one's name; I don't know that one's yet."

Page 71

544. Of course I may truthfully say "I know what this colour is called in English", at the same time as I point (for example) to the colour of fresh blood. But -- -- --

Page 71

17.4.

Page 71

545. 'A child knows which colour is meant by the word "blue".' What he knows here is not all that simple.

Page Break 72

Page 72

546. I should say "I know what this colour is called" if e.g. what is in question is shades of colour whose name not everybody knows.

Page 72

547. One can't yet say to a child who is just beginning to speak and can use the words "red" and "blue": "Come on, you know what this colour is called called!"

Page 72

548. A child must learn the use of colour words before it can ask for the name of a colour.

Page 72

549. It would be wrong to say that I can only say "I know that there is a chair there" when there is a chair there. Of course it isn't *true* unless there is, but I have a right to say this if I am *sure* there is a chair there, even if I am wrong.
[Pretensions are a mortgage which burdens a philosopher's capacity to think.]

Page 72

18.4.

Page 72

550. If someone believes something, we needn't always be able to answer the question 'why he believes it'; but if he knows something, then the question "how does he know?" must be capable of being answered.

Page 72

551. And if one does answer this question, one must do so according to generally accepted axioms. *This* is how something of this sort may be known.

Page 72

552. Do I know that I am now sitting in a chair?--Don't I know it?! In the present circumstances no one is going to say that I know this; but no more will he say, for example, that I am conscious. Nor will one normally say this of the passers-by in the street.

But now, even if one doesn't say it, does that make it *untrue*??

Page 72

553. It is queer: if I say, without any special occasion, "I know"--for example, "I know that I am now sitting in a chair", this statement seems to me unjustified and presumptuous. But if I make the same statement where there is some need for it, then, although I am not a jot more certain of its truth, it seems to me to be perfectly justified and everyday.

Page Break 73

Page 73

554. In its language-game it is not presumptuous. There, it has no higher position than, simply, the human language-game. For there it has its restricted application.

But as soon as I say this sentence outside its context, it appears in a false light. For then it is as if I wanted to insist that there are things that I *know*. God himself can't say anything to me about them.

Page 73

19.4

555. We say we know that water boils when it is put over a fire. How do we know? Experience has taught us.--I say "I know that I had breakfast this morning"; experience hasn't taught me that. One also says "I know that he is in pain". The language-game is different every time, we are *sure* every time, and people will agree with us that we are *in a position* to know every time. And that is why the propositions of physics are found in textbooks for everyone.

If someone says he *knows* something, it must be something that, by general consent, he is in a position to know.

Page 73

556. One doesn't say: he is in a position to believe that.

Page 73

But one does say: "It is reasonable to assume that in this situation" (or "to believe that").

Page 73

557. A court-martial may well have to decide whether it was reasonable in such-and-such a situation to have assumed this or that with confidence (even though wrongly).

Page 73

558. We say we know that water boils and does not freeze under such-and-such circumstances. Is it conceivable that we are wrong? Wouldn't a mistake topple all judgment with it? More: what could stand if that were to fall? Might someone discover something that made us say "It was a mistake"?

Whatever may happen in the future, however water may behave in the future,--we *know* that up to now it has behaved *thus* in innumerable instances.

This fact is fused into the foundations of our language-game:

Page 73

559. You must bear in mind that the language-game is so to say something unpredictable. I mean: it is not based on grounds. It is not reasonable (or unreasonable).

It is there--like our life.

Page Break 74

Page 74

560. And the concept of knowing is coupled with that of the language-game.

Page 74

561. "I know" and "You can rely on it". But one cannot always substitute the latter for the former.

Page 74

562. At any rate it is important to imagine a language in which *our* concept 'knowledge' does not exist.

Page 74

563. One says "I know that he is in pain" although one can produce no convincing grounds for this.--Is this the same as "I am sure that he..."?--No. "I am sure" tells you my subjective certainty. "I know" means that I who know it, and the person who doesn't are separated by a difference in understanding. (Perhaps based on a difference in degree of experience.)

If I say "I know" in mathematics, then the justification for this is a proof.

Page 74

If in these two cases instead of "I know", one says "you can rely on it" then the substantiation is of a different kind in each case.

And substantiation comes to an end.

Page 74

564. A language-game: bringing building stones, reporting the number of available stones. The number is sometimes estimated, sometimes established by counting. Then the question arises "Do you believe there are as many stones as that?", and the answer "I know there are--I've just counted them". But here the "I know" could be dropped. If, however, there are several ways of finding something out for sure, like counting, weighing, measuring the stack, then the statement "I know" can take the place of mentioning *how* I know.

Page 74

565. But here there isn't yet any question of any 'knowledge' that *this* is called "a slab", *this* "a pillar", etc.

Page 74

566. Nor does a child who learns my language-game (No. 2)†1 learn to say "I know that this is called 'a slab'".

Now of course there is a language-game in which the child uses *that* sentence. This presupposes that the child is already capable of using the name as soon as he is given it. (As if someone were to tell me "this colour is called...".)--Thus, if the child

Page Break 75

has learnt a language-game with building stones, one can say something like "and *this* stone is called '...'", and in this way the original language-game has been *expanded*.

Page 75

567. And now, is my knowledge that I am called L. W. of the same kind as knowledge that water boils at 100°C.? Of course, this question is wrongly put.

Page 75

568. If one of my names were used only very rarely, then it might happen that I did not know it. It goes without saying that I know my name, only because, like anyone else, I use it over and over again.

Page 75

569. An inner experience cannot shew me that I *know* something.

Page 75

Hence, if in spite of that I say, "I know that my name is...", and yet it is obviously not an empirical proposition, -- -- --

Page 75

570. "I know this is my name; among us any grown-up knows what his name is."

Page 75

571. "My name is... you can rely on that. If it turns out to be wrong you need never believe me in the future."

Page 75

572. Don't I seem to know that I can't be wrong about such a thing as my own name?

This comes out in the words: "If that is wrong, then I am crazy." Very well, but those are words; but what influence has it on the application of language?

Page 75

573. Is it through the impossibility of anything's convincing me of the contrary?

Page 75

574. The question is, what *kind* of proposition is: "I know I can't be mistaken about that", or again "I can't be mistaken about that"?

This "I know" seems to prescind from all grounds: I simply *know* it. But if there can be any question at all of being mistaken here, then it must be possible to test whether I know it.

Page 75

575. Thus the purpose of the phrase "I know" might be to indicate where I can be relied on; but where that's what it's doing, the usefulness of this sign must emerge from *experience*.

Page Break 76

Page 76

576. One might say "How do I know that I'm not mistaken about my name?"--and if the reply was "Because I have used it so often", one might go on to ask "How do I know that I am not mistaken about *that*?" And here the "How do I know" cannot any longer have any significance.

Page 76

577. "My knowledge of my name is absolutely definite."

I would refuse to entertain any argument that tried to show the opposite!

And what does "I *would* refuse" mean? Is it the expression of an intention?

Page 76

578. But mightn't a higher authority assure me that I don't know the truth? So that I had to say "Teach me!"? But then my eyes would have to be opened.

Page 76

579. It is part of the language-game with people's names that everyone knows his name with the greatest certainty.

Page 76

20.4.

580. It might surely happen that whenever I said "I know" it turned out to be wrong. (Shewing up.)

Page 76

581. But perhaps I might nevertheless be unable to help myself, so that I kept on declaring "I know...". But ask yourself: how did the child learn the expression?

Page 76

582. "I know that" may mean: I am quite familiar with it--or again: it is certainly so.

Page 76

583. "I know that the name of this in... is '...'"--How do you know?--"I have learnt..."

Could I substitute "In... the name of this is '...'" for "I know etc." in this example?

Page 76

584. Would it be possible to make use of the verb "know" only in the question "How do you know?" following a simple assertion?--Instead of "I already know that" one says "I am familiar with that"; and this follows only upon being told the fact. But†1 what does one say instead of "I know what that is"?

Page 76

585. But doesn't "I know that that's a tree" say something different from "that is a tree"?

Page Break 77

Page 77

586. Instead of "I know what that is" one might say "I can say what that is". And if one adopted this form of expression what would then become of "I know that that is a..."?

Page 77

587. Back to the question whether "I know that that's a..." says anything different from "that is a...". In the first sentence a person is mentioned, in the second, not. But that does not shew that they have different meanings. At all events one often replaces the first form by the second, and then often gives the latter a special intonation. For one speaks differently when one makes an uncontradicted assertion from when one maintains an assertion in face of contradiction.

Page 77

588. But don't I use the words "I know that..." to say that I am in a certain state, whereas the mere assertion "that is a..." does not say this? And yet one often does reply to such an assertion by asking "how do you know?"--"But surely, only because the fact that I assert this gives to understand that I think I know it".--This point could be made in the following way: In a zoo there might be a notice "this is a zebra"; but never "I know that this is a zebra".

"I know" has meaning only when it is uttered by a person. But, given that, it is a matter of indifference whether what is uttered is "I know..." or "That is..."

Page 77

589. For how does a man learn to recognize his own state of knowing something?

Page 77

590. At most one might speak of recognizing a state, where what is said is "I know what that is". Here one can satisfy oneself that one really is in possession of this knowledge.

Page 77

591. "I know what kind of tree that is.--It is a chestnut."

"I know what kind of tree that is.--I know it's a chestnut."

The first statement sounds more natural than the second. One will only say "I know" a second time if one wants especially to emphasize certainty; perhaps to anticipate being contradicted. The first "I know" means roughly: I can say.

But in another case one might begin with the observation "that's a...", and then, when this is contradicted, counter by saying: "I know what sort of a tree it is", and by this means lay emphasis on being sure.

Page Break 78

Page 78

592. "I can tell you what kind of a... that is, and no doubt about it."

Page 78

593. Even when one can replace "I know" by "It is..." still one cannot replace the negation of the one by the negation of the other.

With "I don't know..." a new element enters our language-games.

Page 78

21.4.

594. My name is "L. W." And if someone were to dispute it, I should straightaway make connexions with innumerable things which make it certain.

Page 78

595. "But I can still imagine someone making all these connexions, and none of them corresponding with reality. Why shouldn't I be in a similar case?"

If I imagine such a person I also imagine a reality, a world that surrounds him; and I imagine him as thinking (and speaking) in contradiction to this world.

596. If someone tells me his name is N. N., it is meaningful for me to ask him "Can you be mistaken?" That is an allowable question in the language-game. And the answer to it, yes or no, makes sense.--Now of course this answer is not infallible either, i.e., there might be a time when it proved to be wrong, but that does not deprive the question "Can you be..." and the answer "No" of their meaning.

597. The reply to the question "Can you be mistaken?" gives the statement a definite weight. The answer may also be: "I don't *think* so."

598. But couldn't one reply to the question "Can you..." by saying: "I will describe the case to you and then you can judge for yourself whether I can be mistaken"?

For example, if it were a question of someone's own name, the fact might be that he had never used this name, but remembered he had read it on some document,--but on the other hand the answer might be: "I've had this name my whole life long, I've been called it by everybody." If *that* is not equivalent to the answer "I can't be mistaken", then the latter has no meaning

whatever. And yet quite obviously it points to a very important distinction.

599. For example one could describe the certainty of the proposition that water boils at *circa* 100°C. That isn't e.g. a proposition I have once heard (like this or that, which I could mention). I made the experiment myself at school. The proposition is a very elementary one in our text-books, which are to be trusted in matters like this because...--Now one can offer counter-examples to all this, which show that human beings have held this and that to be certain which later, according to our opinion, proved false. But the argument is worthless.†1 To say: in the end we can only adduce such grounds as *we* hold to be grounds, is to say nothing at all.

I believe that at the bottom of this is a misunderstanding of the nature of our language-games.

600. What kind of grounds have I for trusting text-books of experimental physics?

I have no grounds for not trusting them. And I trust them. I know how such books are produced--or rather, I believe I know. I have some evidence, but it does not go very far and is of a very scattered kind. I have heard, seen and read various things.

22.4.

601. There is always the danger of wanting to find an expression's meaning by contemplating the expression itself, and the frame of mind in which one uses it, instead of always thinking of the practice. That is why one repeats the expression to oneself so often, because it is as if one must see what one is looking for in the expression and in the feeling it gives one.

23.4.

602. Should I say "I believe in physics", or "I know that physics is true"?

603. I am taught that under *such* circumstances *this* happens. It has been discovered by making the experiment a few times. Not

that that would prove anything to us, if it weren't that this experience was surrounded by others which combine with it to form a system. Thus, people did not make experiments just about falling bodies but also about air resistance and all sorts of other things.

But in the end I rely on these experiences, or on the reports of them, I feel no scruples about ordering my own activities in accordance with them.--But hasn't this trust also proved itself? So far as I can judge--yes.

604. In a court of law the statement of a physicist that water boils at about 100°C. would be accepted unconditionally as truth.

If I mistrusted this statement what could I do to undermine it? Set up experiments myself? What would they prove?

Page 80

605. But what if the physicist's statement were superstition and it were just as absurd to go by it in reaching a verdict as to rely on ordeal by fire?

Page 80

606. That to my mind someone else has been wrong is no ground for assuming that I am wrong now.--But isn't it a ground for assuming that I *might* be wrong? It is *no* ground for any *unsureness* in my judgment, or my actions.

Page 80

607. A judge might even say "That is the truth--so far as a human being can know it". But what would this rider achieve? ("beyond all reasonable doubt").

Page 80

608. Is it wrong for me to be guided in my actions by the propositions of physics? Am I to say I have no good ground for doing so? Isn't precisely this what we call a 'good ground'?

Page 80

609. Supposing we met people who did not regard that as a telling reason. Now, how do we imagine this? Instead of the physicist, they consult an oracle. (And for that we consider them primitive.) Is it wrong for them to consult an oracle and be guided by it?--If we call this "wrong" aren't we using our language-game as a base from which to *combat* theirs?

Page Break 81

Page 81

610. And are we right or wrong to combat it? Of course there are all sorts of slogans which will be used to support our proceedings.

Page 81

611. Where two principles really do meet which cannot be reconciled with one another, then each man declares the other a fool and heretic.

Page 81

612. I said I would 'combat' the other man,--but wouldn't I give him *reasons*? Certainly; but how far do they go? At the end of reasons comes *persuasion*. (Think what happens when missionaries convert natives.)

Page 81

613. If I now say "I know that the water in the kettle on the gas-flame will not freeze but boil", I seem to be as justified in this "I know" as I am in *any*. 'If I know anything I know *this*'.--Or do I know with still *greater* certainty that the person opposite me is my old friend so-and-so? And how does that compare with the proposition that I am seeing with two *eyes* and shall see them if I look in the glass?--I don't know confidently what I am to answer here.--But still there is a difference between the cases. If the water over the gas freezes, of course I shall be as astonished as can be, but I shall assume some factor I don't know of, and perhaps leave the matter to physicists to judge. But what could make me doubt whether this person here is N. N., whom I have known for years? Here a doubt would seem to drag everything with it and plunge it into chaos.

Page 81

614. That is to say: If I were contradicted on all sides and told that this person's name was not what I had always known it was (and I use "know" here intentionally), then in that case the foundation of all judging would be taken away from me.

Page 81

615. Now does that mean: "I can only make judgments at all because things behave thus and thus (as it were, behave kindly)"?

Page 81

616. Why, would it be *unthinkable* that I should stay in the saddle however much the facts bucked?

Page Break 82

Page 82

617. Certain events would put me into a position in which I could not go on with the old language-game any further. In which I was torn away from the *sureness* of the game.

Indeed, doesn't it seem obvious that the possibility of a language-game is conditioned by certain facts?

Page 82

618. In that case it would seem as if the language-game must '*show*' the facts that make it possible. (But that's not how it is.)

Then can one say that only a certain regularity in occurrences makes induction possible? The 'possible' would of course have to be '*logically possible*'.

619. Am I to say: even if an irregularity in natural events did suddenly occur, that wouldn't *have* to throw me out of the saddle. I might make inferences then just as before, but whether one would call that "induction" is another question.

620. In particular circumstances one says "you can rely on this"; and this assurance may be justified or unjustified in everyday language, and it may also count as justified even when what was foretold does not occur. A *language-game exists* in which this assurance is employed.

24.4.

621. If anatomy were under discussion I should say: "I know that twelve pairs of nerves lead from the brain." I have never seen these nerves, and even a specialist will only have observed them in a few specimens.--This just is how the word "know" is correctly used here.

622. But now it is also correct to use "I know" in the contexts which Moore mentioned, at least *in particular circumstances*. (Indeed, I do not know what "I know that I am a human being" means. But even that might be given a sense.)

For each one of these sentences I can imagine circumstances that turn it into a move in one of our language-games, and by that it loses everything that is philosophically astonishing.

623. What is odd is that in such a case I always feel like saying (although it is wrong): "I know that--so far as one can know such a thing." That is incorrect, but something right is hidden behind it.

624. "Can you be mistaken about this colour's being called 'green' in English?" My answer to this can only be "No". If I were to say "Yes, for there is always the possibility of a delusion", that would mean nothing at all.

For is that rider something unknown to the other? And how is it known to me?

625. But does that mean that it is unthinkable that the word "green" should have been produced here by a slip of the tongue or a momentary confusion? Don't we know of such cases?--One can also say to someone "Mightn't you perhaps have made a slip?" That amounts to: "Think about it again".--

But these rules of caution only make sense if they come to an end somewhere.

A doubt without an end is not even a doubt.

626. Nor does it mean anything to say: "The English name of this colour is *certainly* 'green',--unless, of course, I am making a slip of the tongue or am confused in some way."

627. Wouldn't one have to insert this clause into *all* language-games? (Which shows its senselessness.)

628. When we say "Certain propositions must be excluded from doubt", it sounds as if I ought to put these propositions--for example, that I am called L. W.--into a logic-book. For if it belongs to the description of a language-game, it belongs to logic. But that I am called L. W. does not belong to any such description. The language-game that operates with people's names can certainly exist even if I am mistaken about my name,--but it does presuppose that it is nonsensical to say that the majority of people are mistaken about their names.

629. On the other hand, however, it is right to say of myself "I cannot be mistaken about my name", and wrong if I say "perhaps I am mistaken". But that doesn't mean that it is meaningless for others to doubt what I declare to be certain.

630. It is simply the normal case, to be incapable of mistake about the designation of certain things in one's mother tongue.

631. "I can't be making a mistake about it" simply characterizes one kind of assertion.

632. Certain and uncertain memory. If certain memory were not in general more reliable than uncertain memory, i.e., if it were not confirmed by further verification more often than uncertain memory was, then the expression of certainty and uncertainty would not have its present function in language.

Page 84

633. "I can't be making a mistake"--but what if I did make a mistake then, after all? For isn't that possible? But does that make the expression "I can't be etc." nonsense? Or would it be better to say instead "I can hardly be mistaken"? No; for that means something else.

Page 84

634. "I can't be making a mistake; and if the worst comes to the worst I shall make my proposition into a norm."

Page 84

635. "I can't be making a mistake; I was with him today."

Page 84

636. "I can't be making a mistake; but if after all something *should* appear to speak against my proposition I shall stick to it, despite this appearance."

Page 84

637. "I can't etc." shows my assertion its place in the game. But it relates essentially to *me*, not to the game in general.

If I am wrong in my assertion that doesn't detract from the usefulness of the language-game.

Page 84

25.4.

638. "I can't be making a mistake" is an ordinary sentence, which serves to give the certainty-value of a statement. And only in its everyday use is it justified.

Page 84

639. But what the devil use is it if--as everyone admits--I may be wrong about it, and therefore about the proposition it was supposed to support too?

Page 84

640. Or shall I say: the sentence excludes a certain *kind* of failure?

Page 84

641. "He told me about it today--I can't be making a mistake about that."--But what if it does turn out to be wrong?!--Mustn't one make a distinction between the ways in which something 'turns out wrong'?--How *can* it be *shewn* that my

Page Break 85

statement was wrong? Here evidence is facing evidence, and it must be *decided* which is to give way.

Page 85

642. But suppose someone produced the scruple: what if I suddenly as it were woke up and said "Just think, I've been imagining I was called L. W.!"----well, who says that I don't wake up once again and call *this* an extraordinary fancy, and so on?

Page 85

643. Admittedly one can imagine a case--and cases do exist--where after the 'awakening' one never has any more doubt which was imagination and which was reality. But such a case, or its possibility, doesn't discredit the proposition "I can't be wrong".

Page 85

644. For otherwise, wouldn't all assertion be discredited in this way?

Page 85

645. I can't be making a mistake,--but some day, rightly or wrongly, I may think I realize that I was not competent to judge.

Page 85

646. Admittedly, if that always or often happened it would completely alter the character of the language-game.

Page 85

647. There is a difference between a mistake for which, as it were, a place is prepared in the game, and a complete irregularity that happens as an exception.

Page 85

648. I may also convince someone else that I 'can't be making a mistake'.

I say to someone "So-and-so was with me this morning and told me such-and-such". If this is astonishing he may ask me: "You can't be mistaken about it?" That may mean: "Did that really happen *this morning*?" or on the other hand: "Are you sure you understood him properly?" It is easy to see what details I should add to show that I

was not wrong about the time, and similarly to show that I hadn't misunderstood the story. But all that can *not* show that I haven't dreamed the whole thing, or imagined it to myself in a dreamy way. Nor can it show that I haven't perhaps made some *slip of the tongue* throughout. (That sort of thing does happen.)

Page Break 86

Page 86

649. (I once said to someone--in English--that the shape of a certain branch was typical of the branch of an elm, which my companion denied. Then we came past some ashes, and I said "There, you see, here are the branches I was speaking about". To which he replied "But that's an ash"--and I said "I always meant ash when I said elm".)

Page 86

650. This surely means: the possibility of a *mistake* can be eliminated in certain (numerous) cases.--And one does eliminate mistakes in calculation in this way. For when a calculation has been checked over and over again one cannot then say "Its rightness is still only *very probable*--for an error may always still have slipped in". For suppose it did seem for once as if an error had been discovered--why shouldn't we suspect an error *here*?

Page 86

651. I cannot be making a mistake about 12×12 being 144. And now one cannot contrast *mathematical* certainty with the relative uncertainty of empirical propositions. For the mathematical proposition has been obtained by a series of actions that are in no way different from the actions of the rest of our lives, and are in the same degree liable to forgetfulness, oversight and illusion.

Page 86

652. Now can I prophesy that men will never throw over the present arithmetical propositions, never say that now at last they know how the matter stands? Yet would that justify a doubt on our part?

Page 86

653. If the proposition $12 \times 12 = 144$ is exempt from doubt, then so too must non-mathematical propositions be.

Page 86

26.4.51

654. But against this there are plenty of objections.--In the first place there is the fact that " 12×12 etc." is a *mathematical* proposition, and from this one may infer that only mathematical propositions are in this situation. And if this inference is not justified, then there ought to be a proposition that is just as certain, and deals with the process of this calculation, but isn't itself mathematical. I am thinking of such a proposition as: "The multiplication ' 12×12 ', when carried out by people who know how to calculate, will in the great majority of cases give the result '144'".

Page Break 87

Page 87

Nobody will contest this proposition, and naturally it is not a mathematical one. But has it got the certainty of the mathematical proposition?

Page 87

655. The mathematical proposition has, as it were officially, been given the stamp of incontestability. I.e.: "Dispute about other things; *this* is immovable--it is a hinge on which your dispute can turn."

Page 87

656. And one can *not* say that of the proposition that *I* am called L. W. Nor of the proposition that such-and-such people have calculated such-and-such a problem correctly.

Page 87

657. The propositions of mathematics might be said to be fossilized.--The proposition "I am called..." is not. But it too is regarded as *incontrovertible* by those who, like myself, have overwhelming evidence for it. And this not out of thoughtlessness. For, the evidence's being overwhelming consists precisely in the fact that we do not *need* to give way before any contrary evidence. And so we have here a buttress similar to the one that makes the propositions of mathematics incontrovertible.

Page 87

658. The question "But mightn't you be in the grip of a delusion now and perhaps later find this out?"--might also be raised as an objection to any proposition of the multiplication tables.

Page 87

659. "I cannot be making a mistake about the fact that I have just had lunch."

For if I say to someone "I have just eaten" he may believe that I am lying or have momentarily lost my wits but he won't believe that I am making a mistake. Indeed, the assumption that I might be making a mistake has no meaning here.

But that isn't true. I might, for example, have dropped off immediately after the meal without knowing it and have slept for an hour, and now believe I had just eaten.

But still, I distinguish here between different kinds of mistake.

660. I might ask: "*How* could I be making a mistake about my name being L. W.?" And I can say: I can't see how it would be possible.

661. How might I be mistaken in my assumption that I was never on the moon?

662. If I were to say "I have never been on the moon--but I may be mistaken", that would be idiotic.

For even the thought that I might have been transported there, by unknown means, in my sleep, *would not give me any right* to speak of a possible mistake here. I play the game *wrong* if I do.

663. I have a right to say "I can't be making a mistake about this" even if I am in error.

664. It makes a difference: whether one is learning in school what is right and wrong in mathematics, or whether I myself say that I cannot be making a mistake in a proposition.

665. In the latter case I am adding something special to what is generally laid down.

666. But how is it for example with anatomy (or a large part of it)? Isn't what it describes, too, exempt from all doubt?

667. Even if I came to a country where they believed that people were taken to the moon in dreams, I couldn't say to them: "I have never been to the moon. Of course I may be mistaken". And to their question "Mayn't you be mistaken?" I should have to answer: No.

668. What practical consequences has it if I give a piece of information and add that I can't be making a mistake about it?

(I might also add instead: "I can no more be wrong about this than about my name's being L. W.")

The other person might doubt my statement nonetheless. But if he trusts me he will not only accept my information, he will also draw definite conclusions from my conviction, as to how I shall behave.

669. The sentence "I can't be making a mistake" is certainly used in practice. But we may question whether it is then to be taken in a perfectly rigorous sense, or is rather a kind of exaggeration which perhaps is used only with a view to persuasion.

670. We might speak of fundamental principles of human enquiry.

671. I fly from here to a part of the world where the people have only indefinite information, or none at all, about the possibility of flying. I tell them I have just flown there from.... They ask me if I might be mistaken.--They have obviously a false impression of how the thing happens. (If I were packed up in a box it would be possible for me to be mistaken about the way I had travelled.) If I simply tell them that I can't be mistaken, that won't perhaps convince them; but it will if I describe the actual procedure to them. Then they will certainly not bring the possibility of a *mistake* into the question. But for all that--even if they trust me--they might believe I had been dreaming or that magic had made me imagine it.

672. 'If I don't trust *this* evidence why should I trust any evidence?'

673. Is it not difficult to distinguish between the cases in which I cannot and those in which I can *hardly* be mistaken? Is it always clear to which kind a case belongs? I believe not.

674. There are, however, certain types of case in which I rightly say I cannot be making a mistake, and Moore has given a few examples of such cases.

I can enumerate various typical cases, but not give any common characteristic. (N. N. cannot be mistaken about his having flown from America to England a few days ago. Only if he is mad can he take anything else to be possible.)

675. If someone believes that he has flown from America to England in the last few days, then, I believe, he cannot be making a *mistake*.

And just the same if someone says that he is at this moment sitting at a table and writing.

676. "But even if in such cases I can't be mistaken, isn't it possible that I am drugged?" If I am and if the drug has taken away my consciousness, then I am not now really talking and

thinking. I cannot seriously suppose that I am at this moment dreaming. Someone who, dreaming, says "I am dreaming", even if he speaks audibly in doing so, is no more right than if he said in his dream "it is raining", while it was in fact raining. Even if his dream were actually connected with the noise of the rain.

FOOTNOTES

†1 See G. E. Moore, "Proof of an External World", *Proceedings of the British Academy*, Vol. XXV, 1939; also "A Defence of Common Sense" in *Contemporary British Philosophy, 2nd Series*, Ed. J. H. Muirhead, 1925. Both papers are in Moore's *Philosophical Papers*, London, George Allen and Unwin, 1959. *Editors*.

†1 Passage crossed out in MS. (*Editors*)

†1 In English. *Eds*.

†1 *Philosophical Investigations* I §2. *Eds*.

**(² . . . and write with confidence
"In the beginning was the deed.")**

†2

(... and write with confidence)
("In the beginning was the deed.")

Cf. Goethe, *Faust* I. Trans.

†1 *Grundgesetze der Arithmetik* I xvii *Eds*.

†1 *Äußerung*. (*Eds*.)

†1 *Philosophical Investigations* §2. *Eds*.

†1 *The last sentence is a later addition*. (*Eds*.)

†1 *Marginal note*. May it not also happen that we believe we recognize a mistake of earlier times and later come to the conclusion that the first opinion was the right one? etc.

REMARKS ON COLOUR

Ludwig Wittgenstein: REMARKS ON COLOUR

Edited by
G.E.M. ANSCOMBE

Translated by
Linda L. McAlister and
Margarete Schättle

BASIL BLACKWELL

EDITOR'S PREFACE

Part III of this volume reproduces most of a MS book written in Oxford in the Spring of 1950. I have left out material on "inner-outer", remarks about Shakespeare and some general observations about life; all this both was marked as discontinuous with the text and also will appear elsewhere. Part I was written in Cambridge in March 1951: it is a selection and revision of the earlier material, with few additions. It is not clear whether Part II ante- or post-dates Part III. It was part of what was written on undated loose sheets of foolscap, the rest being devoted to certainty. Wittgenstein left these in his room in my house in Oxford when he went to Dr. Bevan's house in Cambridge in February 1951, in the expectation of dying there. His literary executors decided that the whole of this material might well be published, as it gives a clear sample of first-draft writing and subsequent selection. Much of what was not selected is of great interest, and this method of publication involves the least possible editorial intervention.

In the work of determining the text I was much helped by G. H. von Wright's careful typescript of it, and also by an independent typescript made by Linda McAlister and Margarete Schättle. We have to thank them also for their translation. This, with agreed revisions by the editor, is published here.

I should also like to thank Dr. L. Labowsky for reading through the German text.

G. E. M. Anscombe

I

1. A language-game: Report whether a certain body is lighter or darker than another.--But now there's a related one: State the relationship between the lightness of certain shades of colour. (Compare with this: Determining the relationship between the lengths of two sticks--and the relationship between two numbers.)--The form of the propositions in both language-games is the same: "X is lighter than Y". But in the first it is an external relation and the proposition is temporal, in the second it is an internal relation and the proposition is timeless.

2. In a picture in which a piece of white paper gets its lightness from the blue sky, the sky is lighter than the white paper. And yet in another sense blue is the darker and white the lighter colour. (Goethe). On the palette white is the lightest colour.

3. Lichtenberg says that very few people have ever seen pure white. So do most people use the word wrong, then? And how did *he* learn the correct use?--He constructed an ideal use from the ordinary one. And that is not to say a better one, but one that has been refined along certain lines and in the process something has been carried to extremes.

4. And of course such a construct may in turn teach us something about the way we in fact use the word.

Page 2

5. If I say a piece of paper is pure white, and if snow were placed next to it and it then appeared grey, in its normal surroundings I would still be right in calling it white and not light grey. It could be that I use a more refined concept of white in, say, a laboratory (where, for example, I also use a more refined concept of precise determination of time).

Page 2

6. What is there in favor of saying that green is a primary colour, not a blend of blue and yellow? Would it be right to say: "You can only know it directly by looking at the colours"? But how do I know that I mean the same by the words "primary colours" as some other

Page Break 3

person who is also inclined to call green a primary colour? No,--here language-games decide.

Page 3

7. Someone is given a certain yellow-green (or blue-green) and told to mix a less yellowish (or bluish) one--or to pick it out from a number of colour samples. A less yellowish green, however, is not a bluish one (and vice versa), and there is also such a task as choosing, or mixing a green that is neither yellowish nor bluish. I say "or mixing" because a green does not become both bluish" and yellowish because it is produced by a kind of mixture of yellow and blue.

Page 3

8. People might have the concept of intermediary colours or mixed colours even if they never produced colours by mixing (in whatever sense). Their language-games might only have to do with looking for or selecting already existing intermediary or blended colours.

Page 3

9. Even if green is not an intermediary colour between yellow and blue, couldn't there be people for whom there is bluish-yellow, reddish-green? I.e. people whose colour concepts deviate from ours--because, after all; the colour concepts of colour-blind people too deviate from those of normal people, and not every deviation from the norm must be a blindness, a defect.

Page 3

10. Someone who has learnt to find or to mix a shade of colour that is more yellowish, more whitish or more reddish, etc., than a given shade of colour, i.e. who knows the concept of intermediary colours, is (now) asked to show us a reddish-green. He may simply not understand this order and perhaps react as though he had first been asked to point out regular four-, five-, and six-angled plane figures, and then were asked to point out a regular one-angled plane figure. But what if he unhesitatingly pointed to a colour sample (say, to one that we would call a blackish brown)?

Page 3

11. Someone who is familiar with reddish-green should be in a position to produce a colour series which starts with red and ends with green and which perhaps even for us constitutes a continuous

Page Break 4

transition between the two. We would then discover that at the point where we always see the same shade, e.g. of brown, this person sometimes sees brown and sometimes reddish-green. It may be, for example, that he can differentiate between the colours of two chemical compounds that seem to us to be the same colour and he calls one brown and the other reddish-green.

Page 4

12. Imagine that all mankind, with rare exceptions, were red-green colour-blind. Or another case: everyone was either red-green or blue-yellow colour-blind.

Page 4

13. Imagine a *tribe* of colour-blind people, and there could easily be one. They would not have the same colour concepts as we do. For even assuming they speak, e.g. English, and thus have all the English colour words, they would still use them differently than we do and would *learn* their use differently.

Or if they have a foreign language, it would be difficult for us to translate their colour words into ours.

Page 4

14. But even if there were also people for whom it was natural to use the expressions "reddish-green" or "yellowish-blue" in a consistent manner and who perhaps also exhibit abilities which we lack, we would still not be forced to recognize that they see colours which we do not see. There is, after all, no *commonly* accepted criterion for what is a colour, unless it is one of our colours.

Page 4

15. In every serious philosophical question uncertainty extends to the very roots of the problem.

We must always be prepared to learn something totally new.

Page 4

16. The description of the phenomena of colour-blindness is part of psychology: and therefore the description of the phenomena of normal vision, too? Psychology only describes the *deviations* of colour-blindness from normal vision.

Page 4

17. Runge says (in the letter that Goethe reproduced in his *Theory of Colours*), there are transparent and opaque colours. White is an opaque colour.

This shows the indeterminateness in the concept of colour or again in that of sameness of colour.

Page Break 5

Page 5

18. Can a transparent green glass have the same colour as a piece of opaque paper or not? If such a glass were depicted in a painting, the colours would not be transparent on the palette. If we wanted to say the colour of the glass was also transparent in the painting, we would have to call the complex of colour patches which depict the glass its *colour*.

Page 5

19. Why is it that something can be transparent green but not transparent white?

Transparency and reflections exist only in the dimension of depth of a visual image.

The impression that the transparent medium makes is that something lies *behind* the medium. If the visual image is thoroughly monochromatic it cannot be transparent.

Page 5

20. Something white behind a coloured transparent medium appears in the colour of the medium, something black appears black. According to this rule, black on a white background would have to be seen through a 'white, transparent' medium as through a colourless one.

Page 5

21. Runge: "If we were to think of a bluish-orange, a reddish-green, or a yellowish-violet, we would have the same feeling as in the case of a southwesterly northwind.... Both white and Black are opaque or solid.... White water which is pure is as inconceivable as clear milk."

Page 5

22. We do not want to establish a theory of colour (neither a physiological one nor a psychological one), but rather the logic of colour concepts. And this accomplishes what people have often unjustly expected of a theory.

Page 5

23. "White water is inconceivable, etc." That means we cannot describe (e.g. paint), how something white and clear would look, and that means: we don't know what description, portrayal, these words demand of us.

Page 5

24. It is not immediately clear what transparent glass we should say has the *same colour* as an opaque colour sample. If I say, "I am looking for glass of *this colour*" (pointing to a piece of coloured

Page Break 6

paper), that would mean roughly that something white seen through the glass should look like my sample.

If the sample is pink, sky-blue or lilac, we will imagine the glass cloudy, but perhaps too as clear and only slightly reddish, bluish or violet.

Page 6

25. In the cinema we can sometimes see the events in the film as if they lay behind the screen and it were transparent, rather like a pane of glass. The glass would be taking the colour away from things and allowing only white, grey and black to come through. (Here we are not doing physics, we are regarding white and black as colours just like green and red).--We might thus think that we are here imagining a pane of glass that could be called white and transparent. And yet we are not tempted to call it that: so does the analogy with, e.g. a transparent green pane break down somewhere?

Page 6

26. We would say, perhaps, of a green pane: it colours the things behind it green, above all the white behind it.

Page 6

27. When dealing with logic, "One cannot imagine that" means: one doesn't know what one should imagine here.

Page 6

28. Would we say that my fictitious glass pane in the cinema gave the things behind it a white colouring?

Page 6

29. From the rule for the appearance of transparent coloured things that you have extracted from transparent green, red, etc., ascertain the appearance of transparent white! Why doesn't this work?

Page 6

30. Every coloured medium darkens that which is seen through it, it swallows light: now is my white glass also supposed to darken? And the more so the thicker it is? So it would really be a dark glass!

Page 6

31. Why can't we imagine transparent-white glass,--even if there isn't any in actuality? Where does the analogy with transparent coloured glass go wrong?

Page 6

32. Sentences are often used on the borderline between logic and the empirical, so that their meaning changes back and forth and

Page Break 7

they count now as expressions of norms, now as expressions of experience.

(For it is certainly not an accompanying mental phenomenon--this is how we imagine 'thoughts'--but the use, which distinguishes the logical proposition from the empirical one.)

Page 7

33. We speak of the 'colour of gold' and do not mean yellow. "Gold-coloured" is the property of a surface that shines or glitters.

Page 7

34. There is the glow of red-hot and of white-hot: but what would brown-hot and grey-hot look like? Why can't we conceive of these as a lower degree of white-hot?

Page 7

35. "Light is colourless". If so, then in the sense in which numbers are colourless.

Page 7

36. Whatever *looks* luminous does not look grey. Everything grey *looks* as though it is being illuminated.

Page 7

37. What we see as luminous we do not see as grey. But we can certainly see it as white.

Page 7

38. I could, then, see something *now* as weakly luminous, *now* as grey.

Page 7

39. I am not saying here (as the Gestalt psychologists do), that the *impression of white* comes about in such-and-such a way. Rather the question is precisely: what is the meaning of this expression, what is the logic of this concept?

Page 7

40. For the fact that we cannot conceive of something 'glowing grey' belongs neither to the physics nor to the psychology of colour.

Page 7

41. I am told that a substance burns with a grey flame. I don't know the colours of the flames of all substances; so why shouldn't that be possible?

Page 7

42. We speak of a 'dark red light' but not of a 'black-red light'.

Page Break 8

Page 8

43. A smooth white surface can reflect things: But what, then, if we made a mistake and that which appeared to be reflected in such a surface were *really* behind it and seen through it? Would the surface then be white and transparent?

Page 8

44. We speak of a 'black' mirror. But where it mirrors, it darkens, of course, but it doesn't look black, and that which is seen in it does not appear 'dirty' but 'deep'.

Page 8

45. Opacity is not a *property* of the white colour. Any more than transparency is a property of the green.

Page 8

46. And it does not suffice to say, the word "white" is used only for the appearance of surfaces. It could be that we

had two words for "green": one for green surfaces, the other for green transparent objects. The question would remain why there existed no colour word corresponding to the word "white" for something transparent.

Page 8

47. We wouldn't want to call a medium white if a black and white pattern (chess board) appeared unchanged when seen through it, even if this medium reduced the intensity of the other colours.

Page 8

48. We might want not to call a white high-light "white", and thus use that word only for that which we see as the colour of a surface.

Page 8

49. Of two places in my surroundings which I *see* in one sense as being the same colour, in another sense, the one can seem to me white and the other grey.

To me in one context this colour is white in a poor light, in another it is grey in good light.

These are propositions about the concepts 'white' and 'grey'.

Page 8

50. The bucket which I see in front of me is glazed shining white; it would be absurd to call it "grey" or to say "I really see a light grey". But it has a shiny highlight that is far lighter than the rest of its surface part of which is turned toward the light and part away from it, without appearing to be differently coloured. (*Appearing*, not just *being*.)

Page Break 9

Page 9

51. It is not the same thing to say: the impression of white or grey comes about under such-and-such conditions (causal), and: it is an impression in a certain context of colours and forms.

Page 9

52. White as a colour of substances (in the sense in which we say snow is white) is lighter than any other substance-colour; black darker. *Here* colour is a darkening, and if all such is removed from the substance, white remains, and for this reason we can call it "colourless".

Page 9

53. There is no such thing as phenomenology, but there are indeed phenomenological problems.

Page 9

54. It is easy to see that not all colour concepts are logically of the same sort, e.g. the difference between the concepts 'colour of gold' or 'colour of silver' and 'yellow' or 'grey'.

Page 9

55. A colour '*shines*' in its surroundings. (Just as eyes only smile in a face.) A 'blackish' colour--e.g. grey--doesn't '*shine*'.

Page 9

56. The difficulties we encounter when we reflect about the nature of colours (those which Goethe wanted to get sorted out in his *Theory of Colours*) are embedded in the indeterminateness of our concept of sameness of colour.

Page 9

57.

["I feel X"

"I observe X"

X does not stand for the same concept in the first and the second sentences, even if it may stand for the same verbal expression, e.g. for "a pain". For if we ask "what kind of a pain?" in the first case I could answer "This kind" and, for example, stick the questioner with a needle. In the second case I must answer the same question differently; e.g. "the pain in my foot".

In the second sentence X could also stand for "my pain", but not in the first.]

Page 9

58. Imagine someone pointing to a place in the iris of a Rembrandt eye and saying: "The walls in my room should be painted this colour".

Page Break 10

Page 10

59. I paint the view from my window; one particular spot, determined by its position in the architecture of a house, I paint ochre. I say this is the colour I see this spot. That does not mean that I see the colour of ochre here, for in *these* surroundings this pigment may look lighter, darker, more reddish, (etc.). "I see this spot the way I have painted it here with ochre, namely as a strongly reddish-yellow".

But what if someone asked me to give the *exact* shade of colour that I see there?--How should it be

described and how determined? Someone could ask me to produce a colour sample (a rectangular piece of paper of this colour). I don't say that such a comparison would be utterly uninteresting, but it shows us that it isn't from the outset clear how shades of colour are to be compared and what "sameness of colour" means.

Page 10

60. Imagine a painting cut up into small, almost monochromatic bits which are then used as pieces in a jig-saw puzzle. Even when such a piece is not monochromatic it should not indicate any three-dimensional shape, but should appear as a flat colour-patch. Only together with the other pieces does it become a bit of blue sky, a shadow, a highlight, transparent or opaque, etc. Do the individual pieces show us the *real colours* of the parts of the picture?

Page 10

61. We are inclined to believe the analysis of our colour concepts would lead ultimately to the *colours of places* in our visual field, which are independent of any spatial or physical interpretation; for here there is neither light nor shadow, nor high-light, etc., etc..

Page 10

62. The fact that I can say this place in my visual field is grey-green does not mean that I know what should be called an exact reproduction of this shade of colour.

Page 10

63. I see in a photograph (not a colour photograph) a man with dark hair and a boy with slicked-back blond hair standing in front of a kind of lathe, which is made in part of castings painted black, and in part of smooth axles, gears, etc., and next to it a grating made of light galvanized wire. I see the finished iron surfaces as iron-coloured, the boy's hair as blond, the grating as zinc-coloured, despite the fact that everything is depicted in lighter and darker tones of the photographic paper.

Page Break 11

Page 11

64. But do I really see the hair blond in the photograph? And what can be said in favor of this? What reaction of the viewer is supposed to show that he *sees* the hair blond, and doesn't just conclude from the shades of the photograph that it is blond?--If I were asked to describe the photograph I would do so in the most direct manner with these words. If this way of describing it won't do, then I would have to start looking for another.

Page 11

65. If the word "blond" itself can sound blond, then it's even easier for photographed hair to look blond!

Page 11

66. "Can't we imagine certain people having a different geometry of colour than we do?" That, of course, means: Can't we imagine people having colour concepts other than ours? And that in turn means: Can't we imagine people who do *not* have our colour concepts but who have concepts which are related to ours in such a way that we would also call them "colour concepts"?

Page 11

67. Look at your room late in the evening when you can hardly distinguish between colours any longer--and now turn on the light and paint what you saw earlier in the semi-darkness.--How do you compare the colours in such a picture with those of the semi-dark room?

Page 11

68. When we're asked "What do the words 'red', 'blue', 'black', 'white' mean?" we can, of course, immediately point to things which have these colours,--but our ability to explain the meanings of these words goes no further! For the rest, we have either no idea at all of their use, or a very rough and to some extent false one.

Page 11

69. I can imagine a logician who tells us that he has now succeeded in *really* being able to *think* $2 \times 2 = 4$.

Page 11

70. Goethe's theory of the constitution of the colours of the spectrum has not proved to be an unsatisfactory theory, rather it really isn't a theory at all. Nothing can be predicted with it. It is, rather, a vague schematic outline of the sort we find in James's psychology. Nor is there any *experimentum crucis* which could decide for or against the theory.

Page Break 12

Page 12

71. Someone who agrees with Goethe believes that Goethe correctly recognized the *nature* of colour. And nature here is not what results from experiments, but it lies in the concept of colour.

Page 12

72. One thing was irrefutably clear to Goethe: no lightness can come out of darkness--just as more and more shadows do not produce light.--This could be expressed as follows: we may call lilac a reddish-whitish-blue or

brown a blackish-reddish-yellow--but we *cannot* call a white a yellowish-reddish-greenish-blue, or the like. And *that* is something that experiments with the spectrum neither confirm nor refute. It would, however, also be wrong to say, "Just look at the colours in nature and you will see that it is so". For looking does not teach us anything about the concepts of colours.

Page 12

73. I cannot imagine that Goethe's remarks about the characters of the colours and colour combinations could be of any use to a painter; they could be of hardly any to a decorator. The colour of a blood-shot eye might have a splendid effect as the colour of a wall-hanging. Someone who speaks of the character of a colour is always thinking of just *one* particular way it is used.

Page 12

74. If there were a theory of colour harmony, perhaps it would begin by dividing the colours into groups and forbidding certain mixtures or combinations and allowing others. And, as in harmony, its rules would be given no justification.

Page 12

75. There may be mental defectives who cannot be taught the concept 'tomorrow', or the concept 'I', nor to tell time. Such people would not learn the use of the word 'tomorrow' etc..

Now to whom can I describe *what* these people cannot learn? Just to one who has learnt it? Can't I tell A that B cannot learn higher mathematics, even though A hasn't mastered it? Doesn't the person who has learned the game understand the word "chess" differently from someone who hasn't learnt it? There are differences between the use of the word which the former can make, and the use which the latter has learnt.

Page 12

76. Does describing a game always mean: giving a description through which someone can learn it?

Page Break 13

Page 13

77. Do the normally sighted and the colour-blind have the same concept of colour-blindness? The colour-blind not merely cannot learn to use our colour words, they can't learn to use the word "colour-blind" as a normal person does. They cannot, for example, establish colour-blindness in the same way as the normal do.

Page 13

78. There could be people who didn't understand our way of saying that orange is a rather reddish-yellow, and who would only be inclined to say something like that in cases where a transition from yellow through orange to red took place before their eyes. And for such people the expression "reddish-green" need present no difficulties.

Page 13

79. Psychology describes the phenomena of seeing.--For whom does it describe them? *What* ignorance can this description eliminate?

Page 13

80. Psychology describes what was observed.

Page 13

81. Can one describe to a blind person what it's like for someone to *see*?--Certainly. The blind learn a great deal about the difference between the blind and the sighted. But the question was badly put; as though seeing were an activity and there were a description of it.

Page 13

82. I can, of course, observe colour-blindness; then why not seeing?--I can observe what colour judgements a colour-blind person--or a normally sighted person, too--makes *under certain circumstances*.

Page 13

83. People sometimes say (though mistakenly), "Only I can know what I see". But not: "Only I can know whether I am colour-blind". (Nor again: "Only I can know whether I see or am blind".)

Page 13

84. The statement, "I see a red circle" and the statement "I see (am not blind)" are not logically of the same sort. How do we test the truth of the former, and how that of the latter?

Page 13

85. But can I believe that I see and be blind, or believe that I'm blind and see?

Page 13

86. Could a psychology textbook contain the sentence, "There are people who see"? Would this be wrong? But to whom will it communicate anything?

Page Break 14

87. How can it be nonsense to say, "There are people who see", if it is not nonsense to say "There are people who are blind"?

But suppose I had never heard of the existence of blind people and one day someone told me, "There are people who do not see", would I have to understand this sentence immediately? If I am not blind myself must I be conscious that I have the ability to see, and that, therefore, there may be people who do not have this ability?

88. If the psychologist teaches us, "There are people who see", we can then ask him: "And what do you call 'people who see'?" The answer to that would have to be: People who behave so-and-so under such-and-such circumstances.

II

1. We might speak of the colour-impression of a surface, by which we wouldn't mean the colour, but rather the composite of the shades of colour, which produces the impression (e.g.) of a brown surface.

2. Blending in white removes the *colouredness* from the colour; but blending in yellow does not.--Is that the basis of the proposition that there can be no clear transparent white?

3. But what kind of a proposition is that, that blending in white removes the colouredness from the colour?

As I mean it, it can't be a proposition of physics.

Here the temptation to believe in a phenomenology, something midway between science and logic, is very great.

4. What then is the essential nature of *cloudiness*? For red or yellow transparent things are not cloudy; white is cloudy.

5. Is cloudy that which conceals forms, and conceals forms because it obliterates light and shadow?

6. Isn't white that which does away with darkness?

7. We speak, of course, of 'black glass', yet you see a white surface as red through red glass but not as black through 'black' glass.

8. People often use tinted lenses in their eye-glasses in order to see clearly, but never cloudy lenses.

9. "The blending in of white obliterates the difference between light and dark, light and shadow"; does that define the concepts more closely? Yes, I believe it does.

10. If someone didn't find it to be this way, it wouldn't be that he had experienced the contrary, but rather that he wouldn't understand him.

11. In philosophy we must always ask: "How must we look at this problem in order for it to become solvable?"

12. For here (when I consider colours, for example) there is merely an inability to bring the concepts into some kind of order.

We stand there like the ox in front of the newly-painted stall door.

13. Think about how a painter would depict the view through a red-tinted glass. What results is a *complicated* surface picture. I.e. the picture will contain a great many gradations of red and of other colours adjacent to one another. And analogously if you looked through a blue glass.

But how about if you painted a picture such that the places become whitish where, before, something was made bluish or reddish?

14. Is the only difference here that the colours remain as saturated as before when a reddish light is cast on them,

while they don't with the whitish light? But we don't speak of a 'whitish light cast on things' at all!

Page 16

15. If everything looked whitish in a particular light, we wouldn't then conclude that the light source must look white.

Page 16

16. Phenomenological analysis (as e.g. Goethe would have it) is analysis of concepts and can neither agree with nor contradict physics.

Page 16

17. But what if somewhere the following situation prevailed: the light of a white-hot body makes things appear light but whitish, and so weakly-coloured; the light of a red-hot body makes things appear reddish, etc. (Only an invisible light source, not perceptible to the eye, makes them radiate in colours.)

Page 16

18. Yes, suppose even that things only radiated their colours when, in our sense, *no* light fell on them--when, for example, the sky were *black*? Couldn't we then say: only in black light do the full colours appear (to us)?

Page 16

19. But wouldn't there be a contradiction here?

Page 16

20. I don't *see* that the colours of bodies reflect light into my eye.

Page Break 17

III

24.3.50

Page 17

1. ? White must be the lightest colour in a picture.

Page 17

2. In the Tricolour, for example, the white cannot be darker than the blue and red.

Page 17

3. Here we have a sort of mathematics of colour.

26.3

Page 17

4. But pure yellow too is lighter than pure, saturated red, or blue. And is this proposition a matter of experience?--I don't know, for example, whether red (i.e. pure red) is lighter or darker than blue; to be able to say, I would have to see them. And yet, if I had seen them, I would know the answer once and for all, like the result of an arithmetical calculation.

Where do we draw the line here between logic and experience?

Page 17

5. The word whose meaning is not clear is "pure" or "saturated". How do we learn its meaning? How can we tell if people mean the same thing by it? I call a colour (e.g. red) "saturated" if it contains neither black nor white, if it is neither blackish nor whitish.

But this explanation only leads to a provisional understanding.

Page 17

6. What is the *importance* of the concept of saturated colour?

Page 17

7. One fact is obviously important here: namely that people reserve a special place for a given point on the colour wheel, and that they don't have to go to a lot of trouble to remember where the point is, but always find it easily.

Page 17

8. Is there such a thing as a 'natural history of colours' and to what extent is it analogous to a natural history of plants? Isn't the latter temporal, the former nontemporal

Page 17

9. If we say that the proposition "saturated yellow is lighter than saturated blue" doesn't belong to the realm of psychology (for only

Page Break 18

so could it be natural history)--this means that we are not *using* it as a proposition of natural history. And the question then is: what is the other, nontemporal *use* like?

Page 18

10. For this is the only way we can distinguish propositions of 'the mathematics of colour' from those of natural history.

Page 18

11. Or again, the question is this: can we (clearly) distinguish two uses here?

Page 18

12. If you impress two shades of colour on your memory, and A is lighter than B, and then later you call one shade "A" and another "B" but the one you called "B" is lighter than "A", you have called these shades by the wrong names. (This is logic).

Page 18

13. Let the concept of a 'saturated' colour be such that saturated X cannot be lighter than saturated Y at one time and darker at another; i.e. it makes no sense to say it is lighter at one time and darker at another. This determines the concept and is again a matter of logic.

The *usefulness* of a concept determined in this way is not decided here.

Page 18

14. This concept might only have a *very* limited use. And this simply because what we usually call a saturated X is an impression of colour in a particular surrounding. It is comparable to 'transparent' X.

Page 18

15. Give examples of simple language-games with the concept of 'saturated colours'.

Page 18

16. I assume that certain chemical compounds, e.g. the salts of a given acid, have saturated colours and could be recognized by them.

Page 18

17. Or you could tell where certain flowers come from by their saturated colours, e.g. you could say, "That must be an alpine flower because its colour is so intense".

Page 18

18. But in such a case there could be lighter and darker saturated red, etc.

Page 18

19. And don't I have to admit that sentences are often used on the borderline between logic and the empirical, so that their meaning

Page Break 19

shifts back and forth and they are now expressions of norms, now treated as expressions of experience?

For it is not the 'thought' (an accompanying mental phenomenon) but its use (something that surrounds it), that distinguishes the logical proposition from the empirical one.

Page 19

20. (The wrong picture confuses, the right picture helps.)

Page 19

21. The question will be, e.g.: can you teach the meaning of "saturated green" by teaching†1 the meaning of "saturated red", or "yellow", or "blue"?

Page 19

22. A *shine*, a 'high-light' cannot be black. If I were to substitute blackness for the lightness of high-lights in a picture, I wouldn't get black lights. And that is not simply because this is the one and only form in which a high-light occurs in nature, but *also* because we react to a *light* in this spot in a certain way. A flag may be yellow and black, another yellow and white.



Page 19

23. Transparency painted in a picture produces its effect in a different way than opaqueness.

Page 19

24. Why is transparent white impossible?--Paint a transparent red body, and then substitute white for red!

Black and white themselves have a hand in the business, where we have transparency of a colour. Substitute white for red and you no longer have the impression of transparency; just as you no longer have the impression of

solidity if you turn this drawing  into this one .

27.3

Page 19

25. Why isn't a saturated colour simply: *this*, or *this*, or *this*, or *this*?--Because we recognize it or determine it in a different way.

Page 19

26. Something that may make us suspicious is that some people have thought they recognized three primary colours, some four. Some have thought green to be an intermediary colour between blue and yellow, which strikes

me, for example, as wrong, even apart from any *experience*.

Page Break 20

Page 20

Blue and yellow, as well as red and green, seem to me to be opposites--but perhaps that is simply because I am used to seeing them at opposite points on the colour circle.

Indeed, what (so to speak psychological) *importance* does the question as to the number of Pure Colours have for me?

Page 20

27. I seem to see one thing that is of logical importance: if you call green an intermediary colour between blue and yellow, then you must also be able to say, for example, what a slightly bluish yellow is, or an only somewhat yellowish blue. And to me these expressions don't mean anything at all. But mightn't they mean something to someone else?

So if someone described the colour of a wall to me by saying: "It was a somewhat reddish yellow," I could understand him in such a way that I could choose approximately the right colour from among a number of samples. But if someone described the colour in *this* way: "It was a somewhat bluish yellow," I could not show him such a sample.--Here we usually say that in the one case we can imagine the colour, and in the other we can't--but this way of speaking is misleading, for there is no need whatsoever to think of an image that appears before the inner eye.

Page 20

28. There is such a thing as perfect pitch and there are people who don't have it; similarly we could suppose that there could be a great range of different talents with respect to seeing colours. Compare, for example, the concept 'saturated colour' with 'warm colour'. Must it be the case that everyone knows 'warm' and 'cool' colours? Apart from being taught to give this or that name to a certain disjunction of colours.

Couldn't there be a painter, for example, who had no concept whatsoever of 'four pure colours' and who even found it ridiculous to talk about such a thing?

Page 20

29. Or in other words: are people for whom this concept is not at all natural missing anything?

Page 20

30. Ask this question: Do you know what "reddish" means? And how do you show that you know it?

Language-games: "Point to a reddish yellow (white, blue, brown)--"Point to an even more reddish one"--"A less reddish one" etc.

Page Break 21

Now that you've mastered this game you will be told "Point to a somewhat reddish green" Assume there are two cases: Either you do point to a colour (and always the same one), perhaps to an olive green--or you say, "I don't know what that means," or "There's no such thing."

We might be inclined to say that the one person had a different colour concept from the other; or a different concept of '... ish.'

Page 21

31. We speak of "colour-blindness" and call it a *defect*. But there could easily be several differing abilities, none of which is clearly inferior to the others.--And remember, too, that a man may go through life without his colour-blindness being noticed, until some special occasion brings it to light.

Page 21

32. Is it possible then for different people in this way to have different colour concepts?--*Somewhat* different ones. Different with respect to one or another feature. And that will impair their mutual understanding to a greater or lesser extent, but often hardly at all.

Page 21

33. Here I would like to make a general observation concerning the nature of philosophical problems. Lack of clarity in philosophy is tormenting. It is felt as shameful. We feel: we do not know our way about where we *should* know our way about. And nevertheless it *isn't* so. We can get along very well without these distinctions *and* without knowing our way about here.

Page 21

34. What is the connection between the blending of colours and 'intermediary colours'? We can obviously speak of intermediary colours in a language-game in which we do not produce colours by mixing at all, but only *select* existing shades.

Yet *one* use of the concept of an intermediary colour is to recognize the blend of colours which produces a

given shade.

Page 21

35. Lichtenberg says that very few people have ever seen pure white. Do most people use the word wrong, then? And how did *he* learn the correct use?--On the contrary: he constructed an ideal use from the actual one. The way we construct a geometry. And 'ideal' does not mean something specially good, but only something carried to extremes.

Page 21

36. And of course such a construct can in turn teach us something about the actual use.

Page Break 22

Page 22

And we could also *introduce* a new concept of 'pure white', e.g. for scientific purposes.
(A new concept of this sort would then correspond to, say, the chemical concept of a 'salt'.)

Page 22

37. To what extent can we compare black and white to yellow, red and blue, and to what extent can't we?

If we had a checked wall-paper with red, blue, green, yellow, black and white squares, we would not be inclined to say that it is made up of two kinds of parts, of 'coloured' and, say, 'uncoloured' ones.

Page 22

38. Let us now suppose that people didn't contrast coloured pictures with black-and-white ones, but rather with blue-and-white ones. I.e.: couldn't blue too be felt (and that is to say, used) as not being an actual colour?

Page 22

39. My feeling is that blue obliterates yellow,--but why shouldn't I call a somewhat greenish yellow a "bluish yellow" and green an intermediary colour between blue and yellow, and a strongly bluish green a somewhat yellowish blue?

Page 22

40. In a greenish yellow I don't yet notice *anything* blue.--For me, green is one special way-station on the coloured path from blue to yellow, and red is another.

Page 22

41. What advantage would someone have over me who knew a direct route from blue to yellow? And what shows that I don't know such a path?--Does everything depend on my range of possible language-games with the form "...ish"?

Page 22

42. We will, therefore, have to ask ourselves: What would it be like if people knew colours which our people with normal vision do not know? In general this question will not admit of an unambiguous answer. For it is by no means clear that we *must* say of this sort of abnormal people that they know other *colours*. There is, after all, no commonly accepted criterion for what is a colour, unless it is one of our colours.

And yet we could imagine circumstances under which we would say, "These people see other colours in addition to ours."

Page Break 23

Page 23

28.3

43. In philosophy it is not enough to learn in every case *what* is to be said about a subject, but also *how* one must speak about it. We are always having to begin by learning the method of tackling it.

Page 23

44. Or again: In any serious question uncertainty extends to the very roots of the problem.

Page 23

45. One must always be prepared to learn something *totally* new.

Page 23

46. Among the colours: Kinship and Contrast. (And that is logic.)

Page 23

47. What does it mean to say, "Brown is akin to yellow?"

Page 23

48. Does it mean that the task of choosing a somewhat brownish yellow would be readily understood? (Or a somewhat more yellowish brown).

Page 23

49. The coloured intermediary between two colours.

Page 23

50. "Yellow is more akin to red than to blue."

Page 23

51. The differences between black-red-gold and black-red-yellow. Gold counts as a colour here.

Page 23

52. It is a fact that we can communicate with one another about the colours of things by means of six colour words. Also, that we do not use the words "reddish-green", "yellowish-blue" etc.

Page 23

53. Description of a jig-saw puzzle by means of the description of its pieces. I assume that these pieces never exhibit a three-dimensional form, but always appear as small flat bits, single- or many-coloured. Only when they are put together does something become a 'shadow', a 'high-light', a 'concave or convex monochromatic surface', etc.

Page 23

54. I can say: This man does not distinguish between red and green. But can I say that we normal people distinguish between red and green? We could, however, say: "*Here* we see two colours, he sees only *one*."

Page Break 24

Page 24

55. The description of the *phenomena* of colour-blindness is part of psychology. And the description of the phenomena of normal colour vision too? Of course--but what are the presuppositions of such a description and for whom is it a description? Or better: what are the means it employs? When I say, "What does it presuppose?" that means "How must one react to *this description* in order to *understand* it?" Someone who describes the phenomena of colour-blindness in a book describes them in the concepts of the sighted.

Page 24

56. This paper is lighter in some places than in others; but can I say that it is white only in certain places and gray in others?--Certainly, if I painted it, I would mix a gray for the darker places.

A surface-colour is a quality of a surface. One might (therefore) be tempted not to call it a pure colour concept. But then what would a pure one be?!

Page 24

57. It is not correct to say that in a *picture* white must always be the lightest colour. But it must be the lightest one in a flat pattern of coloured patches. A picture might show a book made of white paper in shadow, and lighter than this a luminous yellow or blue or reddish sky. But if I describe a plane surface, a wallpaper, for example, by saying that it consists of pure yellow, red, blue, white and black squares, the yellow ones cannot be lighter than the white ones, and the red cannot be lighter than the yellow.

This is why colours were shadows for Goethe.

Page 24

58. There seems to be a more fundamental' colour concept than that of the surface colour. It seems that one could present it either by means of small coloured elements in the field of vision, or by means of luminous points rather like stars. And larger coloured areas are composed of these coloured points or small coloured patches. Thus we could describe the colour impression of a surface area by specifying the position of the numerous small coloured patches within this area.

But how should we, for example, compare one of these small colour samples with a piece of the larger surface area? In what surroundings should the colour sample occur?

Page Break 25

Page 25

59. In everyday life we are virtually surrounded by impure colours. All the more remarkable that we have formed a concept of *pure* colours.

Page 25

29.3

60. Why don't we speak of a 'pure' brown? Is the reason merely the position of brown with respect to the other 'pure' colours, its relationship to them all?--Brown is, above all, a surface colour, i.e. there is no such thing as a *clear* brown, but only a muddy one. Also: brown contains black--(?)--How would a person have to behave for us to say of him that he knows a *pure, primary* brown?

Page 25

61. We must always bear in mind the question: How do people learn the meaning of colour names?

Page 25

62. What does, "Brown contains black," mean? There are more and less blackish browns. Is there one which isn't

blackish at all? There certainly isn't one that isn't *yellowish* at all. †1

Page 25

63. If we continue to think along these lines, 'internal properties' of a colour gradually occur to us, which we hadn't thought of at the outset. And that can show us the course of a philosophical investigation. We must always be prepared to come across a new one, one that has not occurred to us earlier.

Page 25

64. And we must not forget either that our colour words characterize the impression of a surface over which our glance wanders. That's what they're for.

Page 25

65. "Brown light". Suppose someone were to suggest that a traffic light be *brown*.

Page 25

66. It is only *to be expected* that we will find adjectives (as, for example, "iridescent") which are colour characteristics of an extended area or of a small expanse in a particular surrounding "shimmering", "glittering", "gleaming", "luminous").

Page 25

67. And indeed the pure colours do not even have special commonly used names, that's how unimportant they are to us.

Page Break 26

Page 26

68. Let us imagine that someone were to paint something from nature and in its natural colours. Every bit of the surface of such a painting has a definite colour. What colour? How do I determine its name? Should we, e.g. use the name under which the pigment applied to it is sold? But mightn't such a pigment look completely different in its special surrounding than on the palette?

Page 26

69. So perhaps we would then start to give special names to small coloured patches on a black background (for example).

What I really want to show here is that it is not at all clear a priori which are the simple colour concepts.

30.3

Page 26

70. It is not true that a darker colour is at the same time a more blackish one. That's certainly clear. A saturated yellow *is* darker, but is not more blackish than a whitish yellow. But amber isn't a 'blackish yellow' either. (?) And yet people speak of a 'black' glass or mirror.--Perhaps the trouble is that by "black" I mean essentially a surface colour?

I would not say of a ruby that it is blackish red, for that would suggest cloudiness. (On the other hand, don't forget that both cloudiness and transparency can be *painted*.)

Page 26

71. I treat colour concepts like the concepts of sensations.

Page 26

72. The colour concepts are to be treated like the concepts of sensations.

Page 26

73. There is no such thing as *the* pure colour concept.

Page 26

74. Where does the illusion come from then? Aren't we dealing here with a premature simplification of logic like any other?

Page 26

75. I.e., the various colour concepts are certainly closely related to one another, the various 'colour words' have a related use, but there are, on the other hand, all kinds of differences.

Page 26

76. Runge says that there are transparent and opaque colours. But this does not mean that you would use different greens to paint a piece of green glass and a green cloth in a picture.

Page Break 27

Page 27

77. It is a peculiar step taken in painting, that of depicting a highlight by means of a colour.

Page 27

78. The indefiniteness in the concept of colour lies, above all, in the indefiniteness of the concept of the sameness of colours, i.e. of the method of comparing colours.

Page 27

79. There is gold paint, but Rembrandt didn't use it to paint a golden helmet.

Page 27

80. What makes grey a neutral colour? Is it something physiological or something logical?

What makes bright colours bright? Is it a conceptual matter or a matter of cause and effect?

Why don't we include black and white in the colour circle? Only because we have a feeling that it's wrong?

Page 27

81. There is no such thing as luminous grey. Is that part of the concept of grey, or part of the psychology, i.e. the natural history, of grey? And isn't it odd that I don't know?

Page 27

82. Colours have characteristic causes and effects--that we do know.

Page 27

83. Grey is between two extremes (black and white), and can take on the hue of any other colour.

Page 27

84. Would it be conceivable for someone to see as black everything that we see as white, and *vice versa*?

Page 27

85. In a brightly coloured pattern black and white can be next to red and green, etc. without standing out as different.

This would not be the case, however, in the colour circle, if only because black and white mix with all the other colours. But also in particular, they both mix with their opposite pole.

Page 27

86. Can't we imagine people having a geometry of colours different from our normal one? And that, of course, means: can we describe it, can we immediately respond to the request to describe it, that is, do we know *unambiguously* what is being demanded of us?

The difficulty is obviously this: isn't it precisely the geometry of colours that shows us what we're talking about, i.e. that we are talking about colours?

Page Break 28

Page 28

87. The difficulty of imagining it (or of filling out the picture of it) is in knowing when one has pictured *that*. I.e. the indefiniteness of the request to imagine it.

Page 28

88. The difficulty is, therefore, one of knowing what we are supposed to consider as the analogue of something that is familiar to us.

Page 28

89. A colour which would be 'dirty' if it were the colour of a wall, needn't be so in a painting.

Page 28

90. I doubt that Goethe's remarks about the characters of the colours could be of any use to a painter. They could hardly be any to a decorator.

Page 28

91. If there were a theory of colour harmony, perhaps it would begin by dividing the colours into different groups and forbidding certain mixtures or combinations and allowing others; and, as in harmony, its rules would be given no justification.

Page 28

92. Mayn't that open our eyes to the *nature* of those differentiations among colours?

Page 28

93. [We don't say A knows something and B knows the opposite. But if we say "believes" instead of "knows", then it is a proposition.]

Page 28

94. Runge to Goethe: "If we were to think of a bluish orange, a reddish green or a yellowish violet, we would have the same feeling as in the case of a southwesterly northwind."

Also: what amounts to the same thing, "Both white and black are opaque or solid.... White water which is pure is as inconceivable as clear milk. If black merely made things dark, it could indeed be clear; but because it smirches things, it can't be."

Page 28

95. In my room I am surrounded by objects of different colours. It is easy to say what colour they are. But if I were

asked what colour I am now seeing from here at, say, *this* place on my table, I couldn't answer; the place is whitish (because the light wall makes the brown table lighter here) at any rate it is much lighter than the rest of the table, but, given a number of colour samples, I wouldn't be able to pick out one which had the same coloration as this area of the table.

Page Break 29

Page 29

96. Because it seems so to me--or to everybody--it does not follow that it *is* so.

Therefore: From the fact that this table seems brown to everyone, it does not follow that it is brown. But just what does it mean to say, "This table isn't really brown after all"?--So *does* it then follow from its appearing brown to us, that it is brown?

Page 29

97. Don't we just *call* brown the table which under certain circumstances appears brown to the normal-sighted? We could certainly conceive of someone to whom things seemed sometimes this colour and sometimes that, independently of the colour they are.

Page 29

98. That it seems so to men is their criterion for its *being* so.

Page 29

99. Being and seeming may, of course, be independent of one another in exceptional cases, but that doesn't make them logically independent; the language-game does not reside in the exception.

Page 29

100. *Golden* is a surface colour.

Page 29

101. We have *prejudices* with respect to the use of words.

Page 29

102. When we're asked "What do 'red', 'blue', 'black', 'white, mean?" we can, of course, immediately point to things which have these colours,--but that's all we can do: our ability to explain their meaning goes no further.

Page 29

103. For the rest, either we have no idea at all, or a very rough and to some extent false one.

Page 29

104. 'Dark' and 'blackish' are not the same concept.

Page 29

105. Runge says that black 'dirties'; what does that mean? Is that an emotional effect which black has on us? Is it an *effect* of the addition of black colour that is meant here?

Page 29

106. Why is it that a dark yellow doesn't have to be perceived as 'blackish', even if we call it dark?

The logic of the concept of colour is just much more complicated than it might seem.

Page Break 30

Page 30

107. The concepts 'matt' and 'shiny'. If, when we think of 'colour' we think of a property of a point in space, then the concepts matt and shiny have no reference to these colour concepts.

Page 30

108. The first 'solution' which occurs to us for the problem of colours is that the 'pure' colour concepts refer to points or tiny indivisible patches in space. Question: how are we to compare the colours of two such points? Simply by letting one's gaze move from one to the other? Or by moving a coloured object? If the latter, how do we know that this object has not changed colour in the process; if the former, how can we compare the coloured points without the comparison being influenced by what surrounds them?

Page 30

109. I could imagine a logician who tells us that he has now succeeded in *really* being able to *think* $2 \times 2 = 4$.

Page 30

110. If you are not clear about the role of logic in colour concepts, begin with the simple case of, e.g. a yellowish red. This exists, no one doubts that. How do I learn the use of the word "yellowish"? Through language-games in which, for example, things are put in a certain order.

Thus I can learn, in agreement with other people, to recognize yellowish and still more yellowish red, green, brown and white.

Page 30

In the course of this I learn to proceed independently just as I do in arithmetic. One person may react to the order to find a yellowish blue by producing a blue green, another may not understand the order. What does this depend upon?

Page 30

111. I say blue-green contains *no* yellow: if someone else claims that it certainly does contain yellow, who's right? How can we check? Is there only a verbal difference between us?--Won't the one recognize a pure green that tends neither toward blue nor toward yellow? And of what use is this? In what language-games can it be used? He will at least be able to respond to the command to pick out the green things that contain *no* yellow, and those that contain *no* blue. And this constitutes the demarcation point 'green', which the other does not know.

Page 30

112. The one can learn a language-game that the other one cannot. And indeed *this must* be what constitutes colour-blindness of all

Page Break 31

kinds. For if the 'colour-blind' person could learn all the language-games of normal people, why should he be excluded from certain professions?

Page 31

113. If someone had called this difference between green and orange to Runge's attention, perhaps he would have given up the idea that there are only *three* primary colours.

Page 31

114. Now to what extent is it a matter of logic rather than psychology that someone can or cannot learn a game?

Page 31

115. I say: The person who cannot play *this* game does not have *this* concept.

Page 31

116. Who has the concept 'tomorrow'? Of whom do we say this?

Page 31

117. I saw in a photograph a boy with slicked-back blond hair and a dirty light-coloured jacket, and a man with dark hair, standing in front of a machine which was made in part of castings painted black, and in part of finished, smooth axles, gears, etc., and next to it a grating made of light galvanized wire. The finished iron parts were iron coloured, the boy's hair was blond, the castings black, the grating zinc-coloured, despite the fact that everything was depicted simply in lighter and darker shades of the photographic paper.

Page 31

118. There may be mental defectives who cannot be taught the concept 'tomorrow' or the concept 'I', nor to tell time. Such would not learn the use of the word 'tomorrow' etc.

Page 31

119. Now to whom can I communicate *what* this mental defective cannot learn.? Just to whoever has learned it himself? Can't I tell someone that so-and-so cannot learn higher mathematics, even if this person himself hasn't mastered it? And yet: doesn't the person who has learned higher mathematics know more precisely what I mean? Doesn't the person who has learned the game understand the word 'chess' differently from someone who doesn't know it? What do we call "describing a technique"?

Page Break 32

Page 32

120. Or: Do normally sighted people and colour-blind people have the same concept of colour-blindness?

And yet the colour-blind person understands the statement "I am colour-blind", and its negation as well.

A colour-blind person not merely can't learn to use our colour words, he can't learn to use the word "colour-blind" exactly as a normal person does. He cannot for example always determine colour-blindness in cases where the normal-sighted can.

Page 32

121. And to whom can I describe all the things *we* normal people can learn?

Understanding the description itself already presupposes that he has learned something.

Page 32

122. How can I describe to someone how we use the word "tomorrow"? I can *teach* it to a child; but this does not mean I'm describing its use to him.

But can I describe the practice of people who have a concept, e.g. 'reddish-green', that we don't possess?--In any case I certainly can't *teach* this practice to anyone.

Page 32

123. Can I then only say: "These people call *this* (brown, for example) reddish green"? Wouldn't it then just be another word for something that I have a word for? If they really have a different concept than I do, this must be shown by the fact that I can't quite figure out their use of words.

Page 32

124. But I have kept on saying that it's conceivable for our concepts to be different than they are. Was that all nonsense?

11.4

Page 32

125. Goethe's theory of the origin of the spectrum *isn't* a theory of its origin that has proved unsatisfactory; it is really not a theory at all. *Nothing* can be predicted by means of it. It is, rather, a vague schematic outline, of the sort we find in James's psychology. There is no *experimentum crucis* for Goethe's theory of colour.

Someone who agrees with Goethe finds that Goethe correctly recognized the nature of colour. And here 'nature' does not mean a sum of experiences with respect to colours, but it is to be found in the concept of colour.

Page Break 33

Page 33

126. One thing was clear to Goethe: no lightness can come out of darkness-just as more and more shadows do not produce light. This could however be expressed as follows: we may, for example, call lilac a "reddish-whitish-blue", or brown a "reddish-blackish-yellow", but we *cannot* call white a "yellowish-reddish-greenish-blue" (or the like). And *that* is something that Newton didn't prove either. White is not a blend of colours in *this* sense.

12.4

Page 33

127. 'The colours' are not things that have definite properties, so that one could straight off look for or imagine colours that we don't yet know, *or* imagine someone who knows different ones than we do. It is quite possible that, under certain circumstances, we would say that people know colours that we don't know, but we are not forced to say this, for there is no indication as to what we should regard as adequate analogies to our colours, in order to be able to say it. This is like the case in which we speak of infra-red 'light'; there is a good reason for doing it, but we can also call it a misuse.

And something similar is true with my concept 'having pain in someone else's body'.

Page 33

128. There could very easily be a tribe of people who are all colour-blind and who nonetheless live very well; but would they have developed all our colour names, and how would their nomenclature correspond to ours? What would their natural language be like?? Do we know? Would they perhaps have three primary colours: blue, yellow and a third which takes the place of red and green?--What if we were to encounter such a tribe and wanted to learn their language? We would no doubt run into certain difficulties.

Page 33

129. Couldn't there be people who didn't understand our way of speaking when we say that orange is a reddish-yellow (etc.) and who were only inclined to say this in cases in which orange occurs in an actual transition from red to yellow? And for such people there might very well be a reddish green.

Page 33

Therefore, they couldn't 'analyse blends of colours' nor could they learn our use of X-ish Y. (Like people without perfect pitch).

Page 33

130. And what about people who only had colour-shape concepts? Should I say of them that they do not *see* that a green leaf and a

Page Break 34

green table--when I show them these things--have the same colour or have something in common? What if it had never 'occurred to them' to compare differently shaped objects of the same colour with one another? Due to their particular background, this comparison was of no importance to them, or had importance only in very exceptional cases, so that no linguistic tool was developed.

Page 34

131. A language-game: report on the greater lightness or darkness of bodies.--But now there is a *related* one: state the relationship between the lightness of certain *colours*. (Compare: the relationship between the lengths of two given sticks -the relationship between two given numbers.)

The form of the propositions is the same in both cases ("X lighter than Y"). But in the first language-game they are temporal and in the second non-temporal.

132. In a particular meaning of "white" white is the lightest colour of all.

In a picture in which a piece of white paper gets its lightness from the blue sky, the sky is lighter than the white paper. And yet in another sense blue is the darker and white the lighter colour (Goethe). With a white and a blue on the palette, the former would be lighter than the latter. On the palette, white is the lightest colour.

133. I may have impressed a certain grey-green upon my memory so that I can always correctly identify it without a sample. Pure red (blue, etc.) however, I can, so to speak, always reconstruct. It is simply a red that tends neither to one side nor to the other, and I recognize it without a sample, as e.g. I do a right angle, by contrast with an arbitrary acute or obtuse angle.

134. Now in this sense there are four (or, with white and black, six) pure colours.

135. A *natural history* of colours would have to report on their occurrence in nature, not on their *essence*. Its propositions would have to be temporal ones.

136. By analogy with the other colours, a black drawing on a white background seen through a transparent *white* glass would have to

appear unchanged as a black drawing on a white background. For the black must remain black and the white, because it is also the colour of the transparent body, remains unchanged.

137. We could imagine a glass through which black looked like black, white like white, and all the other colours appeared as shades of grey; so that seen through it everything appears as though in a photograph.

But why should I call that "white glass"?

138. The question is: is constructing a 'transparent white body' like constructing a 'regular triangle'?

139. I can look at a body and perhaps *see* a matt white surface, i.e. get the *impression* of such a surface, or the *impression* of transparency (whether it actually exists or not). This impression may be produced by the distribution of the colours, and white and the other colours are not involved in it in the *same* way.

(I took a green painted lead cupola to be translucent greenish glass without knowing at the time about the special distribution of colours that produced this appearance.)

140. And white may indeed occur in the visual impression of a transparent body, for example as a reflection, as a high-light. I.e. if the impression is perceived as transparent, the white which we see will simply not be *interpreted* as the body's being white.

141. I look through a transparent glass: does it follow that I don't see white? No, but I don't see the glass as white. But how does this come about? It can happen in various ways. I may see the white with *both* eyes as lying behind the glass. But simply in virtue of its position I may also see the white as a high-light (even when it isn't). And yet we're dealing here with seeing, not just taking something to be such-and-such. Nor is it at all necessary to use both eyes in order to see something as lying *behind* the glass.

142. The various 'colours' do not all have the same connexion with three-dimensional vision.

143. And it doesn't matter whether we explain this in terms of childhood experience or not.

144. It must be the connection between three-dimensionality, light and shadow.

145. Nor can we say that white is essentially the property of a--visual--surface. For it is conceivable that white should occur as a high-light or as the colour of a flame.

146. A body that is actually transparent can, of course, seem white to us; but it cannot seem white and transparent.

147. But we should not express this by saying: white is not a transparent colour.

148. 'Transparent' could be compared with 'reflecting'.

149. An element of visual space may be white or red, but can't be either transparent or opaque.

150. Transparency and reflection only exist in the dimension of depth of a visual image.

151. Why can't a monochromatic surface in the field of vision be amber-coloured? This colour-word refers to a transparent medium; thus if a painter paints a glass with amber-coloured wine in it, you could call the surface of the picture where this is depicted "amber-coloured", but you could not say this of any one monochromatic element of this surface.

152. Mightn't shiny black and matt black have different colour-names?

153. We don't say of something which looks transparent that it looks white.

154. "Can't we imagine people having a different geometry of colour than we do?"--That, of course, means: Can't we imagine people who have colour concepts which are other than ours; and that in turn means: Can't we imagine that people do not have our colour concepts and that they *have* concepts which are related to ours in such a way that we would also want to call them "colour concepts"?

155. †1 If people were used to seeing nothing but green squares and red circles, they might regard a green circle with the same kind of mistrust with which they would regard a freak, and, for example, they might even say it is *really* a red circle, but has something of a...†1

If people only had colour-shape concepts, they would have a special word for a red square and one for a red circle, and one for a green circle, etc. Now if they were to see a new *green* figure, should no similarity to the green circle, etc. occur to them? And shouldn't it occur to them that there is a similarity between green circles and red circles? But what do I want to say counts as showing that this similarity has occurred to them?

They might, *for example*, have a concept of 'going together'; and still not think of using colour words.

In fact there are tribes which only count up to 5 and they have probably not felt it necessary to describe anything that can't be described in this way.

156. Runge: "Black dirties". That means it takes the *brightness* out of a colour, but what does that mean? Black takes away the luminosity of a colour. But is that something logical or something psychological? There is such a thing as a luminous red, a luminous blue, etc., but no luminous black. Black is the, darkest of the colours. We say "deep black" but not "deep white".

But a 'luminous red' does not mean a *light* red. A dark red can be luminous too. But a colour is luminous as a result of its context, in its context.

Grey, however, is not luminous.

But black seems to make a colour cloudy, but darkness doesn't. A ruby could thus keep getting darker without ever becoming cloudy; but if it became blackish red, it would become cloudy. Now black is a surface colour. Darkness is not called a colour. In paintings darkness *can* also be depicted as black.

The difference between black and, say, a dark violet is similar to the difference between the sound of a bass drum and the sound of a kettle-drum. We say of the former that it is a noise not a tone. It is matt and absolutely black.

157. Look at your room late in the evening when you can hardly distinguish between colours any longer; and now turn on the light and paint what you saw in the twilight. There are pictures of landscapes or rooms in semi-darkness: But how do you compare the colours in such pictures with those you saw in semi-darkness? How different this comparison is from that of two colour samples which I have in front of me at the same time and compare by putting

them side by side!

Page 38

158. What is there in favour of saying that green is a primary colour and not a mixture of blue and yellow? Is it correct to answer: "You can only know it directly, by looking at the colours"? But how do I know that I mean the same by the words "primary colours" as someone else who is also inclined to call green a primary colour? No, here there are language-games that decide these questions.

There is a more or less bluish (or yellowish) green and someone may be told to mix a green less yellow (or blue) than a given yellow (or blue) one, or to pick one out from a number of colour samples. A less yellow green, however, is not a bluer one (and vice versa), and someone may also be given the task of choosing-or mixing-a green that is neither yellowish nor bluish. And I say "or mixing", because a green is not both yellowish and bluish on account of being produced by mixing yellow and blue.

Page 38

159. Consider that things can be reflected in a smooth white surface in such a way that their reflections seem to lie behind the surface and in a *certain* sense are seen through it.

Page 38

160. If I say a piece of paper is pure white and then place snow next to it and it then appears grey, in normal surroundings and for ordinary purposes I would call it white and not light grey. It could be that I'd use a different and, in a certain sense, more refined concept of white in, say, a laboratory, (where I sometimes also use a more refined concept of 'precise' determination of time).

Page 38

161. The pure saturated colours are essentially characterized by a certain relative lightness. Yellow, for example, is lighter than red. Is red lighter than blue? I don't know.

Page Break 39

Page 39

162. Someone who has learned the concept of intermediary colours, who has mastered the technique and who thus can find or mix shades of colour that are more whitish, more yellowish, more bluish than a given shade and so on, is now asked to pick out or to mix a reddish green.

Page 39

163. Someone who is familiar with reddish green should be in a position to produce a colour series which starts with red and ends with green and constitutes for us too a continuous transition between the two. We might then discover that at the point where we perhaps always see the same shade of brown, this person sometimes sees brown and sometimes reddish green. It may be, for example, that he can differentiate between the colours of two chemical compounds that seem to us to be the same colour, and he calls one "a brown" and the other "reddish green".

Page 39

164. In order to describe the phenomenon of red-green colour-blindness, I need only say what someone who is red-green colourblind *cannot* learn; but now in order to describe the 'phenomena of normal vision' I would have to enumerate the things we *can* do.

Page 39

165. Someone who describes the 'phenomena of colour-blindness' describes only the ways in which the colour-blind person *deviates* from the normal, not his vision in general.

But couldn't she also describe the ways in which normal vision deviates from total blindness? We might ask: who would learn from this? Can someone teach me that I see a tree?

And what is a 'tree', and what is 'seeing'?

Page 39

166. We can, for example, say: *This* is the way a person acts with a blindfold over his eyes, and *this* is the way a sighted person without a blindfold acts. With a blindfold he reacts thus and so, without the blindfold he walks briskly along the street, greets his acquaintances, nods to this one and that, avoids the cars and bicycles easily when he crosses the street, etc., etc. Even with new-born infants, we know that they can see from the fact that they follow movements with their eyes. Etc., etc.. The question is: who is supposed to understand the description? Only sighted people, or blind people too?

It makes sense, for example *[[sic]]*, to say "the sighted person distinguishes with his eyes between an unripe apple and a ripe one." But

Page Break 40

not: "The sighted person distinguishes a green apple from a red one." For what are 'red' and 'green'?

Marginal note: "The sighted person distinguishes an apple that appears red to him from one which appears

green."

But can't I say "I distinguish *this kind* of apple from *this kind*" (while pointing to a red apple and a green one)?

But what if someone points at two apples that seem to me to be exactly alike and says that?! On the other hand he could say to me "Both of them look exactly alike to you, so you might confuse them; but I see a difference and I can recognize each of them any time." That can be tested and confirmed.

Page 40

167. What is the experience that teaches me that I differentiate between red and green?

Page 40

168. Psychology describes the phenomena of seeing. For whom does it describe them? What ignorance can this description eliminate?

Page 40

169. If a sighted person had never heard of a blind person, couldn't we describe the behaviour of the blind person to him?

Page 40

170. I can say: "The colour-blind person cannot distinguish between a green apple and a red one" and that can be demonstrated. But can I say "I can distinguish between a green apple and a red one"? Well, perhaps by the taste. But still, for example, "I can distinguish an apple that you call 'green' from one that you call 'red', therefore I am not colour-blind".

Page 40

171. This piece of paper varies in lightness from place to place, but does it look grey to me in the darker places? The shadow that my hand casts is in part grey. I see the parts of the paper that are farther away from the light darker but still white, even though I would have to mix a grey to paint it. Isn't this similar to the fact that we often see a distant object merely as distant and not as smaller? Thus we cannot say "I notice that he looks smaller, and I conclude from that that he is farther away", but rather I notice that he is farther away, without being able to say how I notice it.

Page 40

172. The impression of a coloured transparent medium is that something is behind the medium. Thus if we have a thoroughly monochromatic visual image, it cannot be one of transparency.

Page Break 41

Page 41

173. Something white behind a coloured transparent medium appears in the colour of the medium, something black appears black. According to this rule a black drawing on white paper behind a white transparent medium must appear as though it were behind a colourless medium.

That†1 was not a proposition of physics, but rather a rule of the spatial interpretation of our visual experience. We could also say, it is a rule for painters: "If you want to portray something white behind something that is transparent and red, you have to paint it red." If you paint it white, it doesn't look as though it is behind the red thing.

Page 41

174. In the places where there is only a little less light on the white paper it doesn't seem at all grey, but always white.

Page 41

175. The question is: What must our visual picture be like if it is to show us a transparent medium? How must, e.g., the colour of the medium appear? Speaking in physical terms--although we are not directly concerned with the laws of physics here--everything seen through a green glass must look more or less dark green. The lightest shade would be that of the medium. That which we see through it is, thus, similar to a photograph. Now if we apply all this to white glass, everything should again look as though it were photographed, but in shades ranging from white to black. And if there were such glass--why shouldn't we want to call it *white*? Is there anything to be said against doing this; does the analogy with glass of other colours break down at any point?

Page 41

176. A cube of green glass looks green when it's lying in front of us. The overall impression is green; thus the overall impression of the white cube should be white.

Page 41

177. Where must the cube appear white for us to be able to call it white and transparent?

Page 41

178. Is it *because* the relationships and contrasts between white and the other colours are different from those between green and the other colours, that for white there is nothing analogous to a transparent green glass?

179. When light comes through it red glass casts a red light; now what would light coming through a white glass look like? Would yellow become whitish in such a light or merely lighter? And would black become grey or would it remain black?

180. We are not concerned with the facts of physics here except insofar as they determine the laws governing how things appear.

181. It is not immediately clear which transparent glass we should say had the 'same colour' as a piece of green paper.

182. If the paper is, e.g. pink, sky-blue or lilac we would imagine the glass to be somewhat *cloudy*, but we could also suppose it to be just a rather weak reddish, etc., clear glass. That's why something colourless is sometimes called "white".

183. We could say, the colour of a transparent glass is that which a white light source would appear when seen through that glass.

But seen through a *colourless* glass it appears as uncloudy *white*.

184. In the cinema it is often possible to see the events as 'though they were occurring behind the screen, as if the screen were transparent like a pane of glass. At the same time, however, the colour would be removed from these events and only white, grey and black would come through. But we are still not tempted to call it a transparent, *white* pane of glass.

How, then, would we see things through a pane of green glass? *One* difference would, of course, be that the green glass would diminish the difference between light and dark, while the other one shouldn't have any effect upon this difference. Then a 'grey transparent' pane would somewhat diminish it.

185. We might say of a pane of green glass that it gave things its colour. But does my 'white' pane do that?--If the green medium gives its colour to things, then, above all, to *white* things.

186. A thin layer of a coloured medium colours things only weakly: how should a thin 'white' glass colour them? Shall we suppose that it doesn't quite remove all their colour?

187. "We shouldn't be able to conceive of white water that is pure..." That is to say: we cannot describe how something white could look clear, and that means: we don't know what description is being asked for with these words.

188. We do not want to find a theory of colour (neither a physiological nor a psychological one), but rather the logic of colour concepts. And this accomplishes that which people have often unjustly expected from a theory.

189. Explaining colour words by pointing to coloured pieces of paper does not touch the concept of transparency. It is this concept that stands in unlike relations to the various colour concepts.

190. Thus, if someone wanted to say we don't even notice that the concepts of the different colours are so different, we would have to answer that he had simply paid attention to the analogy (the likeness) between these concepts, while the differences lie in the relations to other concepts. [A better remark on this.]

191. If a pane of green glass gives the things behind it a green colour, it turns white to green, red to black, yellow to greenish yellow, blue to greenish blue. The white pane should, therefore, make everything whitish, i.e. it should make everything *pale*; and, then why shouldn't it turn black to grey?--Even a yellow glass makes things darker, should a white glass make things darker too?

192. Every coloured medium makes the things seen through it darker in that it swallows up light: Now is my white

glass supposed to make things darker too, and more so the thicker it is? But it ought to leave white white: So the 'white glass' would really be a dark glass.

Page 43

193. If green becomes whitish through it, why doesn't grey become more whitish, and why doesn't black then become grey?

Page 43

194. Coloured glass mustn't make the things behind it lighter: so what should happen in the case of, e.g. something green? Should I see it as a grey-green?†1 then how should something green be seen through it? whitish-green?†1

Page Break 44

Page 44

195. If all the colours became whitish the picture would lose more and more depth.

Page 44

196. Grey is not poorly illuminated white, dark green is not poorly illuminated light green.

It is true that we say "At night all cats are grey", but that really means: we can't distinguish what colour they are and they *could* be grey.

Page 44

197. What constitutes the decisive difference between white and the other colours? Does it lie in the asymmetry of the relationships? And that is really to say, in the special position it has in the colour octohedron? Or is it rather the unlike position of the colours *vis-à-vis* dark and light?

Page 44

198. What should the painter paint if he wants to create the effect of a white, transparent glass?

Should red and green (etc.) become whitish?

Page 44

199. Isn't the difference simply that every coloured glass should impart colour to the white, while my glass must either leave it unchanged or simply make it darker?

Page 44

200. White seen through a coloured glass appears with the colour of the glass. That is a rule of the appearance of transparency. So white appears white through white glass, i.e. as through uncoloured glass.

Page 44

201. Lichtenberg speaks of 'pure white' and means by that the *lightest* of colours. No one could say that of pure yellow.

Page 44

202. It is odd to say white is solid, because of course yellow and red can be the colours of surfaces too, and as such, we do not categorially [[sic]] differentiate them from white.

Page 44

203. If we have a white cube with different strengths of illumination on its surfaces and look at it through a yellow glass, it now looks yellow and its surfaces still appear differently illuminated. How would it look through white glass? And how would a yellow cube look through white glass?

Page 44

204. Would it be as if we had mixed white or as if we had mixed grey with its colours?

Page Break 45

Page 45

205. Wouldn't it be possible for a glass to leave white, black and grey unchanged and make the rest of the colours whitish? And wouldn't this come close to being a white and transparent glass? The effect would then be like a photograph which still retained a trace of the natural colours. The degree of darkness of each colour would then have to be preserved, and certainly not *diminished*.

Page 45

206. This much I can understand: that a physical theory (such as Newton's) cannot solve the problems that motivated Goethe, even if he himself didn't solve them either.

Page 45

207. If I look at pure red through glass and it looks grey, has the glass actually given the colour a grey content? I.e.: or does it only *appear so*?

Page 45

208. Why do I feel that a white glass must colour black if it colours anything, while I can accept the fact that yellow

is swallowed up by black? Isn't it because clear coloured glass must colour white above all, and if it doesn't do that and is white, then it is cloudy.

Page 45

209. If you look at a landscape and screw up your eyes, the colours become less clear and everything begins to take on the character of black and white; but does it seem to me here as if I saw it through a pane of this or that coloured glass?

Page 45

210. We often speak of white as not coloured. Why? (We even do it when we are not thinking about transparency.)

Page 45

211. And it is strange that white sometimes appears on an equal footing with the other pure colours (as in flags), and then again sometimes it doesn't.

Why, for example, do we say that whitish green or red is "not *saturated*"? Why does white, but not yellow, make these colours weaker? Is that a matter of the psychology (the effect) of colours, or of their logic? Well, the fact that we use certain words such as "saturated", "muddy", etc. is a psychological matter; but that we make a sharp distinction at all, indicates that it is a conceptual matter.

Page 45

212. Is that connected with the fact that white gradually eliminates *all* contrasts, while red doesn't?

Page Break 46

Page 46

213. One and the same musical theme has a different character in the minor than in the major, but it is completely wrong to speak of the character of the minor mode in general. (In Schubert the major often sounds more sorrowful than the minor.)

And in this way I think that it is worthless and of no use whatsoever for the understanding of painting to speak of the characteristics of the individual colours. When we do it, we are really only thinking of special uses. That green as the colour of a tablecloth has this, red that effect, does not allow us to draw any conclusions as to their effect in a picture.

Page 46

214. White cancels out all colours,--does red do this too?

Page 46

215. Why is there no brown nor grey light? Is there no white light either? A luminous body can appear white but neither brown nor grey.

Page 46

216. Why can't we imagine a grey-hot?

Why can't we think of it as a lesser degree of white-hot?

Page 46

217. That something which seems luminous cannot also appear grey must be an indication that something luminous and colourless is always called "white"; this teaches us something about our concept of white.

Page 46

218. A weak white light is not a grey light.

Page 46

219. But the sky which illumines everything that we see can be grey! And how do I know merely by its appearance that it isn't itself luminous?

Page 46

220. That is to say roughly: something is 'grey' or 'white' only in a particular surrounding.

Page 46

221. I am not saying here what the Gestalt psychologists say: that the *impression of white* comes about in such and such a way. Rather the question is precisely: what is the impression of white, what is the meaning of this expression, what is the logic of this concept 'white'?

Page 46

222. For the fact that we cannot conceive of something 'grey-hot' does not pertain to the psychology of colours.

Page Break 47

Page 47

223. Imagine we were told that a substance burns with a grey flame. You don't know the colours of the flames of all substances: so why shouldn't that be possible? And yet it would mean nothing. If I heard such a thing, I would only think that the flame was *weakly luminous*.

Page 47

224. Whatever *looks* luminous does not look grey. Everything grey *looks* as though it is being illumined.

That something can 'appear luminous' is caused by the distribution of lightness in what is seen, but there is also such a thing as 'seeing something *as* luminous'; under certain circumstances one can take reflected light to be the light from a luminous body.

Page 47

225. I could, then, see something *now* as weakly luminous, *now* as grey.

Page 47

226. What we see as luminous we don't see as grey. But we can certainly see it as white.

Page 47

227. We speak of a 'dark red light', but not of a 'black-red light'.

Page 47

228. There is such a thing as the *impression* of luminosity.

Page 47

229. It is not the same thing to say: the impression of white or grey comes about under such and such conditions (causally), and to say that it is the impression of a certain context (definition). (The first is Gestalt psychology, the second logic.)

Page 47

230. The "primary phenomenon" (*Urphänomen*) is, e.g., what Freud thought he recognized in simple wish-fulfilment dreams. The primary phenomenon is a preconceived idea that takes possession of us.

Page 47

231. If a ghost appeared to me during the night, it could glow with a weak whitish light; but if it looked grey, then the light would have to appear as though it came from somewhere else.

Page 47

232. When psychology speaks of appearance, it connects it with reality. But we can speak of appearance alone, or we connect appearance with appearance.

Page Break 48

Page 48

233. We might say, the colour of the ghost is that which I must mix on the palette in order to paint it accurately.

Page 48

But how do we determine what the accurate picture is?

Page 48

234. Psychology connects what is experienced with something physical, but we connect what is experienced with what is experienced.

Page 48

235. We could paint semi-darkness in semi-darkness. And the 'right lighting' of a picture could be semi-darkness. (Stage scene-painting.)

Page 48

236. A smooth white surface can reflect things: But what, then, if we made a mistake and that which appeared to be reflected in such a surface were really behind it and seen through it? Would the surface then be white and transparent? Even then what we saw would not correspond to something, coloured and transparent.

Page 48

237. We speak of a 'black mirror'. But when it mirrors, it darkens, of course, but it doesn't look black, and its black doesn't 'smirch'.

Page 48

238. Why is green drowned in the black, while white isn't?

Page 48

239. There are colour concepts that only refer to the visual appearance of a surface, and there might be such as refer only to the appearance of transparent media, or rather to the visual impression of such media. We might want not to call a white high-light on silver, say, "white", and differentiate it from the white colour of a surface. I believe this is where the talk of "transparent" light comes from.

Page 48

240. If we taught a child the colour concepts by pointing to coloured flames, or coloured transparent bodies, the peculiarity of white, grey and black would show up more clearly.

Page 48

241. It is easy to see that not all colour concepts are logically of the same kind. It is easy to see the difference

between the concepts: 'the colour of gold' or 'the colour of silver' and 'yellow' or 'grey'.

But it is hard to see that there is a somewhat related difference between 'white' and 'red'.

Page Break 49

Page 49

242. Milk is not opaque because it is white,--as if white were something opaque.

If 'white' is a concept which only refers to a visual surface, why isn't there a colour concept related to 'white' that refers to transparent things?

Page 49

243. We wouldn't want to call a medium white-coloured, if a black and white pattern (chess board) appeared unchanged when seen through it, even if this medium changed other colours into whitish ones.

Page 49

244. Grey or a weakly illumined or luminous white can in one sense be the same colour, for if I *paint* the latter I may have to mix the former on the palette.

Page 49

245. Whether I see something as grey or as white can depend upon how I see the things around me illumined. To me in one context the colour is white in poor light, in another it is grey in good light.

Page 49

246. The bucket which I see in front of me is glazed gleaming white; I couldn't possibly call it grey or say "I really see grey". But it has a highlight that is far lighter than the rest of its surface, and because it is round there is a gradual transition from light to shadow, yet without there seeming to be a change of colour.

Page 49

247. What colour is the bucket at this spot? How should I decide this question?

Page 49

248. There is indeed no such thing as phenomenology, but there are phenomenological problems.

Page 49

249. We would like to say: when you mix in red you do not thin down the colours, when you mix in white you do. On the other hand, we don't always perceive pink or a whitish blue as thinned down.

Page 49

250. Can we say: "Luminous grey is white"?

Page 49

251. The difficulties which we encounter when we reflect about the nature of colours (those difficulties which Goethe wanted to deal with through his theory of colour) are contained in the fact that we have not *one* but several related concepts of the sameness of colours.

Page Break 50

Page 50

252. The question is: What must the visual image be like if we ought to call it that of a coloured, transparent medium? Or again: How must something look for it to appear to us as coloured and transparent? This is not a question of physics, but it is connected with physical questions.

Page 50

253. What is the nature of a visual image that we would call the image of a coloured transparent medium?

Page 50

254. There seem to be what we can call "colours of substances" and "colours of surfaces".

Page 50

255. Our colour concepts sometimes relate to substances (Snow is white), sometimes to surfaces (this table is brown), sometimes to the illumination (in the reddish evening light), sometimes to transparent bodies. And isn't there also an application to a place in the visual field, logically independent of a spatial context?

Can't I say "there I see white" (and paint it, for example) even if I can't in any way give a three-dimensional interpretation of the visual image? (Spots of colour.) (I am thinking of pointillist painting.)

Page 50

256. To be able generally to name a colour, is not the same as being able to copy it exactly. I can perhaps say "There I see a reddish place" and yet I can't mix a colour that I recognize as being exactly the same.

Page 50

257. Try, for example, to paint what you see when you close your eyes! And yet you can *roughly* describe it.

Page 50

258. Think of the colours of polished silver, nickel, chrome, etc. or of the colour of a scratch in these metals.

259. I give a colour the name "F" and I say it is the colour that I see *there*. Or perhaps I paint my visual image and then simply say "I see *this*". Now, what colour is at *this* spot in my image? How do I determine it? I introduce, say, the word "cobalt blue": How do I fix what 'C' is? I could take as the paradigm of this colour a paper or the dye in a pot.

How do I now determine that a surface (for example) has this colour? Everything depends on the method of comparison.

260. What we can call the "coloured" overall impression of a surface is by no means a kind of arithmetical mean of all the colours of the surface.

261.

["I see (hear, feel, etc.) X"
"I am observing X"

X does not stand for the same concept the first time and the second, even if the same expression, e.g. "a pain", is used both times. For the question "what kind of a pain?" could follow the first proposition and one could answer this by sticking the questioner with a needle. But if the question "what kind of a pain?" follows the second proposition, the answer must be of a different sort, e.g. "The pain in my hand.")

262. I would like to say "*this* colour is at *this* spot in my visual field (completely apart from any interpretation)". But what would I use this sentence for? "This" colour must (of course) be one that I can reproduce. And it must be determined under what circumstances I say something is this colour.

263. Imagine someone pointing to a spot in the iris in a face by Rembrandt and saying "the wall in my room should be painted this colour."

264. The fact that we can say "This spot in my visual field is grey-green" does not mean that we know what to call an exact reproduction of this shade of colour.

265. I paint the view from my window; one particular spot, determined by its position in the architecture of a house, I paint ochre. I say "I see this spot in this colour."

That does not mean that I see the colour ochre at this spot, for the pigment may appear much lighter or darker or more reddish (etc.) than ochre, in these surroundings.

I can perhaps say "I see this spot the way I have painted it here (with ochre); but it has a strongly reddish look to me."

But what if someone asked me to give the *exact* shade of colour that appears to me here? How should I describe it and how should I determine it? Someone could ask me, for example, to produce a colour sample, a rectangular piece of paper of this colour. I don't say

that such a comparison is utterly uninteresting, but it shows that it isn't from the outset clear how shades of colour are to be compared, and therefore, what "sameness of colour" means here.

266. Imagine a painting being cut up into small almost monochromatic bits which are then used as pieces in a puzzle. Even when such a piece is not monochromatic, it should not indicate any three-dimensional shape, but should appear as a flat colour-patch. Only together with the other pieces does it become a bit of sky, a shadow, a high-light, a concave or convex surface, etc..

267. Thus we might say that this puzzle shows us the actual colours of the various spots in the picture.

268. One might be inclined to believe that an analysis of our colour concepts would lead ultimately to the colours of places in our visual field, which would be independent of any spatial or physical interpretation, for here there would be neither illumination nor shadow nor high-light, nor transparency nor opaqueness, etc..

269. Something which appears to us as a light monochromatic line without breadth on a dark background can look

white but not grey(?). A planet couldn't look light grey.

Page 52

270. But wouldn't we *interpret* the point or the line as grey under certain circumstances? (Think of a photograph.)

Page 52

271. Do I actually see the boy's hair blond in the photograph?!--Do I see it grey?

Do I only *infer* that whatever looks *this way* in the picture, must in reality be blond?

In one sense I see it blond, in another I see it lighter or darker grey.

Page 52

272. 'Dark red' and 'blackish red' are not the same sort of concepts. A ruby can appear dark red when one looks through it, but if it's clear it cannot appear blackish red. The painter may depict it by means of a blackish red patch, but in the picture this patch will not have a blackish red effect. It is seen as having depth, just as the plane appears to be three-dimensional.

Page Break 53

Page 53

273. In a film, as in a photograph, face and hair do not look *grey*, they make a very natural impression; on the other hand, food on a plate often looks grey and therefore unappetizing in a film.

Page 53

274. What does it mean, though, that hair looks blond in a photograph? How does it come out that it *looks* this way as opposed to our simply *concluding* that this is its colour? Which of our reactions makes us say that?--Doesn't a stone or plaster head look white?

Page 53

275. If the word "blond" itself can sound blond, then it's even easier for photographed hair to look blond!

Page 53

276. It would be very natural for me to describe the photograph in these words "A man with dark hair and a boy with combed-back blond hair are standing by a machine." This is how I would describe the *photograph*, and if someone said that doesn't describe it but the objects that were probably photographed, I could say the picture looks *as though* the hair had been that colour.

Page 53

277. If I were called upon to describe the photograph, I'd do it in these words.

Page 53

278. The colour-blind understand the statement that they are colour-blind. The blind, the statement that they are blind. But they can't use these sentences in as many different ways as a normal person can. For just as the normal person can master language-games with, e.g. colour words, which they cannot learn, he can also master language-games with the words "colour-blind" and "blind".

Page 53

279. Can one explain to a blind person what it's like to *see*?--Certainly; the blind do learn a great deal about the difference between themselves and the sighted. And yet, we want to answer no to this question.--But isn't it posed in a misleading way? We can describe both to someone who does not play soccer and to someone who does 'what it's like to play soccer', perhaps to the latter so that he can check the correctness of the description. Can we then describe to the sighted person what it is like to see? But we *can* certainly explain to him what blindness is! I.e. we can describe to him the characteristic behaviour of a blind person and we can blindfold him. On the other hand, we cannot make a blind person see for a while; we can, however, describe to him how the sighted behave.

Page Break 54

Page 54

280. Can we say 'colour-blindness' (or 'blindness') is a phenomenon and 'seeing' is not?

That would mean something like: "I see" is expression, "I am blind" is not. But after all that's not true. People on the street often take me for blind. I could say to someone who does this "I see", i.e. I am not blind.

Page 54

281. We could say: It is a phenomenon that there are people who can't learn this or that. This phenomenon is colour-blindness.--It would therefore be an inability; seeing, however, would be the ability.

Page 54

282. I say to B, who cannot play chess: "A can't learn chess". B can understand that.--But now I say to someone who is absolutely unable to learn any game, so-and-so can't learn a game. What does he know of the nature of a game? Mightn't he have, e.g. a completely wrong concept of a game? Well, he may understand that we can't invite either him or the other one to a party, because they can't play any games.

283. Does everything that I want to say here come down to the fact that the utterance "I see a red circle" and "I see, I'm not blind" are logically different? How do we test a person to find out if the first statement is true? And to find out if the second is true? Psychology teaches us how to determine colour-blindness, and thereby normal vision too. But *who* can learn this?

284. I can't teach anyone a game that I can't learn myself. A colour-blind person cannot teach a normal person the normal use of colour words. Is that true? He can't give him a *demonstration* of the game, of the use.

285. Couldn't a member of a tribe of colour-blind people get the idea of imagining a strange sort of human being (whom we would call "normally sighted")? Couldn't he, for example, portray such a normally sighted person on the stage? In the same way as he is able to portray someone who has the gift of prophesy without having it himself. It's at least conceivable.

286. But would it ever occur to colour-blind people to call themselves "colour-blind"?--Why not?

But how could 'normally sighted people' learn the 'normal' use of colour words, if they were the exceptions in a colour-blind population?--Isn't it possible that they just use colour words 'normally', and perhaps, in the eyes of the others they make certain mistakes, until the others finally learn to appreciate these unusual abilities.

287. I can imagine (depict), how it would seem to me if I met such a person.

288. I can imagine how a human being would behave who regards that which is important to me as unimportant. But can I imagine his *state*?--What does that mean? Can I imagine the state of someone who considers important what I consider important?

289. I could even exactly imitate someone who was doing a multiplication problem without being able to learn multiplication myself.

And I couldn't then teach others to multiply, although it would be conceivable that I gave someone the impetus to learn it.

290. A colour-blind person can obviously describe the test by which his colour-blindness was discovered. And what he can subsequently describe, he could also have invented.

291. Can one describe higher mathematics to someone without thereby teaching it to him? Or again: *Is* this instruction a *description* of the kind of calculation? To describe the game of tennis to someone is *not* to teach it to him (and vice versa). On the other hand, someone who didn't know what tennis is, and now learns to play, then knows what it is. ("Knowledge by description and knowledge by acquaintance".)

292. Someone who has perfect pitch can learn a language-game that I cannot learn.

293. We could say people's concepts show what matters to them and what doesn't. But it's not as if this *explained* the particular concepts they have. It is only to rule out the view that we have the right concepts and other people the wrong ones. (There is a continuum between an error in calculation and a different mode of calculating.)

294. When blind people speak, as they like to do, of blue sky and other specifically visual phenomena, the sighted person often says "Who knows what he imagines that to mean"--But why doesn't he say this about other sighted people? It is, of course, a wrong expression to begin with.

295. That which I am writing about so tediously, may be obvious to someone whose mind is less decrepit.

296. We say: "Let's imagine human beings who don't know *this* language-game". But this does not give us any clear idea of the life of these people, of where it deviates from ours. We don't yet know what we have to imagine; for the life of these people *is* supposed to correspond to ours for the rest, and it first has to be determined what we would

call a life that corresponds to ours under the new circumstances.

Isn't it as if we said: There are people who play chess without the king? Questions immediately arise: Who wins now, who loses, etc. You have to make *further* decisions which you didn't foresee in that first statement. Just as you don't have an overview of the original technique, you are merely familiar with it from case to case.

Page 56

297. It is also a part of dissembling, to regard others as capable of dissembling.

Page 56

298. If human beings acted in such a way that we were inclined to suspect them of dissembling, but they showed no mistrust of one another, then this doesn't present a picture of people who dissemble.

Page 56

299. 'We cannot help but be constantly surprised by these people'.

Page 56

300. We could portray certain people on the stage and have them speak in monologues (asides) things that in real life they of course would not say out loud, but which would nevertheless correspond to their thoughts. But we couldn't portray an alien kind of humans this way. Even if we could predict their behaviour, we couldn't give them the appropriate asides.

And yet there's something wrong with this way of looking at it. For someone might actually say something to himself while he was going about doing things, and this could simply be quite conventional.

Page Break 57

Page 57

301. That I can be someone's friend rests on the fact that he has the same *possibilities* as I myself have, or similar ones.

Page 57

302. Would it be correct to say our concepts reflect our life? They stand in the middle of it.

Page 57

303. The rule-governed nature of our languages permeates our life.

Page 57

304. When would we say of someone, he doesn't have our concept of pain? I could assume that he knows no pain, but I want to assume that he does know it; we thus assume he gives expressions of pain and we could teach him the words "I have pain". Should he also be capable of remembering his pain?--Should he recognize expressions of pain in others as such; and how is this revealed? Should he show pity?--should he understand make-believe pain *as being just that*?

Page 57

305. "I don't know *how* irritated he was". "I don't know if he was *really* irritated".--Does he know himself? Well, we ask him, and he says, "Yes, I was."

Page 57

306. What then is this *uncertainty* about whether the other person was irritated? Is it a mental state of the uncertain person? Why should we be concerned with that? It lies in the use of the expression "He is irritated".

Page 57

307. But *one* is uncertain, another may be certain: he 'knows the look on this person's face' when he is irritated. How does he learn to know this sign of irritation as being such? That's not easy to say.

Page 57

308. But it is not only: "What does it mean to be uncertain about the state of another person?"--but also "What does it mean 'to *know*, to be certain, that that person is irritated'?"

Page 57

309. Here it could now be asked what I really want, to what extent I want to deal with grammar.

Page 57

310. The certainty that he will visit me and the certainty that he is irritated have something in common. The game of tennis and the game of chess have something in common, too, but no one would

Page Break 58

say here: "It is very simple: they play in both cases, it's just that each time they play something different." *This* case shows us the dissimilarity to "One time he eats an apple, another time a pear", while in the other case it is not so easy to see.

Page 58

311. "I know, that he arrived yesterday"--"I know, that $2 \times 2 = 4$ "--"I know that he had pain"--"I know that there is a

table standing there".

Page 58

312. In each case I know, it's only that it's always something different? *Oh yes*,--but the language-games are far more different than these sentences make us conscious of.

Page 58

313. "The world of physical objects and the world of consciousness". What do I know of *the latter*? What my senses teach me? I.e. how it is, if one sees, hears, feels, etc., etc.--But do I really learn that? Or do I learn what it's like when *I now* see, hear, etc., and *I believe* that it was also like this before?

Page 58

314. What actually is the '*world*' of consciousness? There I'd like to say: "What goes on in my mind, what's going on in it now, what I see, hear,..." Couldn't we simplify that and say: "What I am now seeing."

Page 58

315. The question is clearly: How do we compare physical objects--how do we compare experiences?

Page 58

316. What actually is the '*world of consciousness*'?--That which is in my consciousness: what I am now seeing, hearing, feeling....--And what, for example, am I now seeing? The answer to that cannot be: "Well, *all that*" accompanied by a sweeping gesture.

Page 58

317. When someone who believes in God looks around him and asks "Where did everything that I see come from?" "Where did everything come from?" he is *not* asking for a (causal) explanation; and the point of his question is that it is the expression of such a request. Thus, he is expressing an attitude toward all explanations. But how is this shown in his life? It is the attitude that takes a particular matter seriously, but then at a particular point doesn't take it seriously after all, and declares that something else is even more serious.

In this way a person can say it is very serious that so-and-so died

Page Break 59

before he could finish a certain work; and in another sense it doesn't matter at all. Here we use the words "in a profounder sense".

What I actually want to say is that here too it is not a matter of the *words* one uses or of what one is thinking when using them, but rather of the difference they make at various points in life. How do I know that two people mean the same when both say they believe in God? And one can say just the same thing about the Trinity. Theology which insists on the use of *certain* words and phrases and bans others, makes nothing clearer (Karl Barth). It, so to speak, fumbles around with words, because it wants to say something and doesn't know how to express it. *Practices* give words their meaning.

Page 59

318. I observe this patch. "Now it's like *so*"--and simultaneously I point to e.g. a picture. I may constantly *observe* the same thing and what I *see* may then remain the same, or it may change. What I observe and what I see do not have the same (kind of) identity. Because the words "this patch", for example, do not allow us to recognize the (kind of) identity I mean.

Page 59

319. "Psychology describes the phenomena of colour-blindness as well as those of normal sight." What are the '*phenomena of colour-blindness*'? Certainly the reactions of the colour-blind person which differentiate him from the normal person. But certainly not *all* of the colour-blind person's reactions, for example, not those that distinguish him from a blind person.--Can I teach the blind what seeing is, or can I teach this to the sighted? That doesn't mean anything. Then what does it mean: to describe *seeing*? But I can teach human beings the meaning of the words "blind" and "sighted", and indeed the sighted learn them, just as the blind do. Then do the blind know what it is like to see? But do the sighted know? Do they also know what it's like to have consciousness?

But can't psychologists observe the difference between the behaviour of the sighted and the blind? (Meteorologists the difference between rain and drought?). We certainly could, e.g. observe the difference between the behaviour of rats whose whiskers had been removed and of those which were not mutilated in this way. And perhaps we could call that describing the role of this tactile apparatus.--The lives of the blind are different from those of the sighted.

Page 59

320. The normal person can, e.g. learn to take dictation. What is that? Well, one person speaks and the other writes down what he

Page Break 60

says. Thus, if he says e.g. the sound *a*, the other writes the symbol "a", etc. Now mustn't someone who *understands* this explanation either already have known the game, only perhaps not by this name,--or have learnt it from the description? But Charlemagne certainly understood the principle of writing and still couldn't learn to write. Someone can thus also understand the description of a technique yet not be able to learn it. But there are two cases of not-being-able-to-learn. In the one case we merely fail to acquire a certain competence, in the other we lack comprehension. We can *explain* a game to someone: He may understand this explanation, but not be able to learn the game, or he may be incapable of understanding my explanation of the game. But the opposite is conceivable as well.

Page 60

321. "You see the tree, the blind do not see it". This is what I would have to say to a sighted person. And so do I have to say to the blind: "You do not see the tree, we see it"? What would it be like for the blind man to believe that he saw, or for me to believe I couldn't see?

Page 60

322. Is it a phenomenon that I see the tree? It is one that I correctly recognize this as a tree, that I am not blind.

Page 60

323. "I see a tree", as the expression of the visual impression,--is this the description of a phenomenon? *What* phenomenon? How can I explain this to someone?

And yet isn't the fact that I have this visual impression a phenomenon for someone else? Because it is something that he observes, but not something that I observe.

The words "I am seeing a tree" are not the description of a phenomenon. (I couldn't say, for example, "I am seeing a tree! How strange!", but I could say: "I am seeing a tree, but there's no tree there. How strange!")

Page 60

324. Or should I say: "The impression is not a phenomenon; but that L.W. has this impression is one"?

Page 60

325. (We could imagine someone talking to himself and describing the impression as one does a dream, without using the first person pronoun.)

Page Break 61

Page 61

326. To observe is not the same thing as to look at or to view.

"Look at this colour and say what it reminds you of". If the colour changes you are no longer looking at the one I meant.

One observes in order to see what one would not see if one did not observe.

Page 61

327. We say, for example "Look at this colour for a certain length of time". But we don't do that in order to *see* more than we had seen at first glance.

Page 61

328. Could a "Psychology" contain the sentence: "There are human beings who see"?

Well, would that be false?--But to whom would this communicate anything? (And I don't just mean: what is being communicated is a long familiar fact.)

Page 61

329. Is it a familiar fact to me that I see?

Page 61

330. We might want to say: If there were no such humans, then we wouldn't have the concept of *seeing*.--But couldn't Martians say something like this? Somehow, by chance, the first humans they met were all blind.

Page 61

331. And how can it be meaningless to say "there are humans who see," if it is not meaningless to say there are humans who are blind?

But the meaning of the sentence "there are humans who see", i.e. its possible use at any rate, is not immediately clear.

Page 61

332. Couldn't seeing be the *exception*? But neither the blind nor the sighted could describe it, except as an ability to do this or that. Including e.g. playing certain language-games; but there we must be careful how we describe these games.

Page 61

333. If we say "there are humans who see", the question follows "And what *is* 'seeing'?" And how should we answer it? By teaching the questioner the use of the word "see"?

Page 61

334. How about this explanation: "There are people who behave like you and me, and not like that man over there, the blind one"?

Page Break 62

Page 62

335. "With your eyes open, you can cross the street and not be run over, etc."

The logic of *information*.

Page 62

336. To say that a sentence which has the form of information has a use, is not yet to say anything about the *kind* of use it has.

Page 62

337. Can the psychologist inform me what seeing is? What do we *call* "informing someone what seeing is?"

Page 62

It is not the psychologist who teaches me the use of the word "seeing".

Page 62

338. If the psychologist informs us "There are people who see", we could ask him "And what do you call 'People who see'?" The answer to that would be of the sort "Human beings who react so-and-so, and behave so-and-so under such-and-such circumstances". "Seeing" would be a technical term of the psychologist, which he explains to us. Seeing is then something which he has observed in human beings.

Page 62

339. We learn to use the expressions "I see...", "he sees...", etc. before we learn to distinguish between seeing and blindness.

Page 62

340. "There are people who can talk", "I can say a sentence", "I can pronounce the word 'sentence'", "As you see, I am awake", "I am here".

Page 62

341. There is surely such a thing as instruction in the circumstances under which a certain sentence can be a piece of information. What should I call this instruction?

Page 62

342. Can I be said to have observed that I and other people can go around with our eyes open and not bump into things and that we can't do this with our eyes closed?

Page 62

343. When I tell someone I am not blind, is that an observation? I can, in any case, convince him of it by my behaviour.

Page Break 63

Page 63

344. A blind man could easily find out if I am blind too; by, for example, making a certain gesture with his hand, and asking me what he did.

Page 63

345. Couldn't we imagine a tribe of blind people? Couldn't it be capable of sustaining life under certain circumstances? And mightn't sighted people occur as exceptions?

Page 63

346. Suppose a blind man said to me: "You can go about without bumping into anything, I can't"--Would he be communicating anything to me in the first part of the sentence?

Page 63

347. Well, he's not telling me anything new.

Page 63

348. There seem to be propositions that have the character of experiential propositions, but whose truth is for me unassailable. That is to say, if I assume that they are false, I must mistrust all my judgements.

Page 63

349. There are, in any case, errors which I take to be commonplace and others that have a different character and which must be set apart from the rest of my judgements as temporary *confusions*. But aren't there transitional cases between these two

Page 63

350. If we introduce the concept of knowing into this investigation, it will be of no help; because knowing is not a

psychological state whose special characteristics explain all kinds of things. On the contrary, the special logic of the concept "knowing" is not that of a psychological state.

Page Break 64

Copyright page

Page 64

Copyright © G. E. M. Anscombe 1977
First published 1977
Reprinted 1978, 1988, 1990, 1995, 1998

Blackwell Publishers Ltd
108 Cowley Road
Oxford OX4 1JF, UK

All rights reserved. Except for the quotation of short passages for the purposes of criticism and review, no part of this publication may be reproduced, stored in a retrieval system, or transmitted, in any form or by any means, electronic, mechanical, photocopying, recording or otherwise, without the prior permission of the publisher.

Except in the United States of America, this book is sold subject to the condition that it shall not, by way of trade or otherwise, be lent, re-sold, hired out, or otherwise circulated without the publisher's prior consent in any form of binding or cover other than that in which it is published and without a similar condition including this condition being imposed on the subsequent purchaser.

British Library Cataloguing in Publication Data
Wittgenstein, Ludwig
Remarks on colour

ISBN 0-631-11641-9

1. Title. 2. Anscombe, Gertrude Elizabeth Margaret 3. McAlister, Linda Lee. 4. Schättle, M.
152.1'45'01 BF789.C7

Colour-sense

Printed and bound in Great Britain by Athenæum Press Ltd, Gateshead, Tyne & Wear

This book is printed on acid-free paper

FOOTNOTES

Page 19

†1 *Translator's note*: Wittgenstein wrote "greenish" here but presumably meant "bluish". Cp. III, § 158

Page 25

†1 The German text had been amended from leert (evacuates) to lehrt (teaches). *Ed.*

Page 37

†1 *Alternative readings*: simpler, purer, more elementary. *Ed.*

Page 37

†1 The MS may contain a question-mark here. *Ed.*

Page 41

†1 This paragraph was crossed out. *Ed.*

Page 43

†1 The MS has an arrow here pointing to "Something white..." above. *Ed.*

Page 43

†1 *Alternative readings*. *Ed.*